

WNM2016

N-Channel, 20V, 3.2A, Power MOSFET

[Http://www.sh-willsemi.com](http://www.sh-willsemi.com)

V _{DS} (V)	Typical R _{DS(on)} (mΩ)
20	40 @ V _{GS} =4.5V
	47 @ V _{GS} =2.5V
	55 @ V _{GS} =1.8V

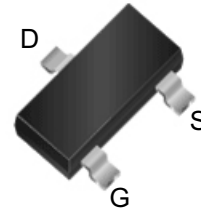

SOT-23

Descriptions

The WNM2016 is N-Channel enhancement MOS Field Effect Transistor. Uses advanced trench technology and design to provide excellent R_{DS(ON)} with low gate charge. This device is suitable for use in DC-DC conversion, power switch and charging circuit. Standard Product WNM2016 is Pb-free and Halogen-free.

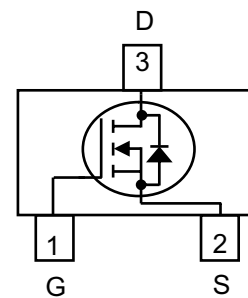

Configuration (Top View)

Features

- Trench Technology
- Supper high density cell design
- Excellent ON resistance for higher DC current
- Extremely Low Threshold Voltage
- Small package SOT-23

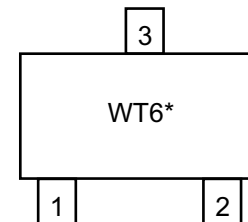

WT6 = Device Code
* = Month (A~Z)

Marking

Applications

- Driver for Relay, Solenoid, Motor, LED etc.
- DC-DC converter circuit
- Power Switch
- Load Switch

Order Information

Device	Package	Shipping
WNM2016-3/TR	SOT-23	3000/Tape&Reel

ABSOLUTE MAXIMUM RATINGS $T_A = 25\text{ }^\circ\text{C}$, unless otherwise noted					
Parameter		Symbol	10 S	Steady State	Unit
Drain-Source Voltage		V_{DS}	20		V
Gate-Source Voltage		V_{GS}	± 8		
Continuous Drain Current ($T_J = 150\text{ }^\circ\text{C}$) ^a	$T_A = 25\text{ }^\circ\text{C}$	I_D	3.2	2.9	A
	$T_A = 70\text{ }^\circ\text{C}$		2.5	2.3	
Maximum Power Dissipation ^a	$T_A = 25\text{ }^\circ\text{C}$	P_D	0.8	0.7	W
	$T_A = 70\text{ }^\circ\text{C}$		0.5	0.4	
Continuous Drain Current ($T_J = 150\text{ }^\circ\text{C}$) ^b	$T_A = 25\text{ }^\circ\text{C}$	I_D	2.9	2.7	A
	$T_A = 70\text{ }^\circ\text{C}$		2.3	2.1	
Maximum Power Dissipation ^b	$T_A = 25\text{ }^\circ\text{C}$	P_D	0.6	0.5	W
	$T_A = 70\text{ }^\circ\text{C}$		0.4	0.3	
Pulsed Drain Current ^c		I_{DM}	10		A
Operating Junction and Storage Temperature Range		T_J, T_{stg}	-55 to 150		$^\circ\text{C}$

THERMAL RESISTANCE RATINGS					
Parameter		Symbol	Typical	Maximum	Unit
Junction-to-Ambient Thermal Resistance ^a	$t \leq 10\text{ s}$	$R_{\theta JA}$	125	150	$^\circ\text{C/W}$
	Steady State		140	175	
Junction-to-Ambient Thermal Resistance ^b	$t \leq 10\text{ s}$	$R_{\theta JA}$	150	180	
	Steady State		165	210	
Junction-to-Case Thermal Resistance	Steady State	$R_{\theta JC}$	60	76	

- a Surface mounted on FR4 Board using 1 in sq pad size, 1oz Cu.
- b Surface mounted on FR4 board using the minimum recommended pad size, 1oz Cu.
- c Repetitive rating, pulse width limited by junction temperature, $t_p = 10\mu\text{s}$, Duty Cycle=1%
- d Repetitive rating, pulse width limited by junction temperature $T_{J(\text{MAX})} = 150\text{ }^\circ\text{C}$.

Electronics Characteristics

(Ta=25°C, unless otherwise noted)

Parameter	Symbol	Test Conditions	Min	Typ	Max	Unit
OFF CHARACTERISTICS						
Drain-to-Source Breakdown Voltage	BV_{DSS}	$V_{GS} = 0\text{ V}, I_D = 250\mu\text{A}$	20			V
Zero Gate Voltage Drain Current	I_{DSS}	$V_{DS} = 16\text{ V}, V_{GS} = 0\text{ V}$			1	μA
Gate-to-source Leakage Current	I_{GSS}	$V_{DS} = 0\text{ V}, V_{GS} = \pm 8.0\text{ V}$			± 100	nA
ON CHARACTERISTICS						
Gate Threshold Voltage	$V_{GS(TH)}$	$V_{GS} = V_{DS}, I_D = 250\mu\text{A}$	0.4	0.6	1	V
Drain-to-source On-resistance	$R_{DS(on)}$	$V_{GS} = 4.5\text{ V}, I_D = 3.6\text{ A}$		40	47	m Ω
		$V_{GS} = 2.5\text{ V}, I_D = 3.1\text{ A}$		47	55	
		$V_{GS} = 1.8\text{ V}, I_D = 1.0\text{ A}$		55	66	
Forward Transconductance	g_{FS}	$V_{DS} = 5\text{ V}, I_D = 3.1\text{ A}$		8.5		S
CHARGES, CAPACITANCES AND GATE RESISTANCE						
Input Capacitance	C_{ISS}	$V_{GS} = 0\text{ V}, f = 1.0\text{ MHz},$ $V_{DS} = 10\text{ V}$		500		pF
Output Capacitance	C_{OSS}			62		
Reverse Transfer Capacitance	C_{RSS}			58		
Total Gate Charge	$Q_{G(TOT)}$	$V_{GS} = 4.5\text{ V}, V_{DS} = 10\text{ V},$ $I_D = 3.1\text{ A}$		8.5		nC
Threshold Gate Charge	$Q_{G(TH)}$			0.45		
Gate-to-Source Charge	Q_{GS}			0.65		
Gate-to-Drain Charge	Q_{GD}			3.1		
SWITCHING CHARACTERISTICS						
Turn-On Delay Time	$t_d(ON)$	$V_{GS} = 4.5\text{ V}, V_{DS} = 10\text{ V},$ $R_L = 3.5\Omega, R_G = 6\Omega$		12		ns
Rise Time	t_r			20.8		
Turn-Off Delay Time	$t_d(OFF)$			38.8		
Fall Time	t_f			10.8		
DRAIN-SOURCE DIODE CHARACTERISTICS						
Forward Recovery Voltage	V_{SD}	$V_{GS} = 0\text{ V}, I_S = 1.0\text{ A}$		0.62	1.5	V

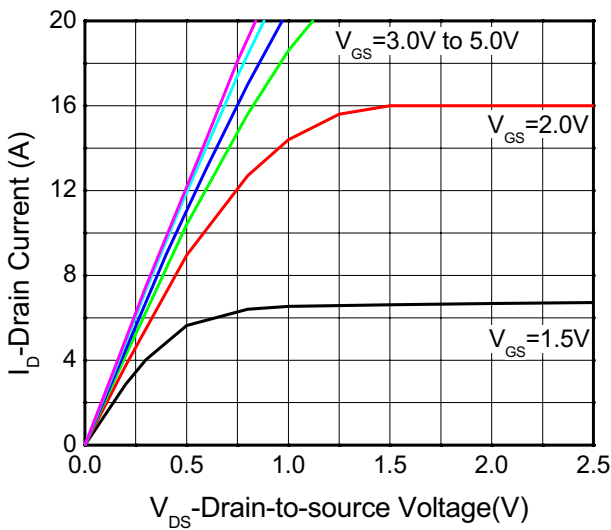
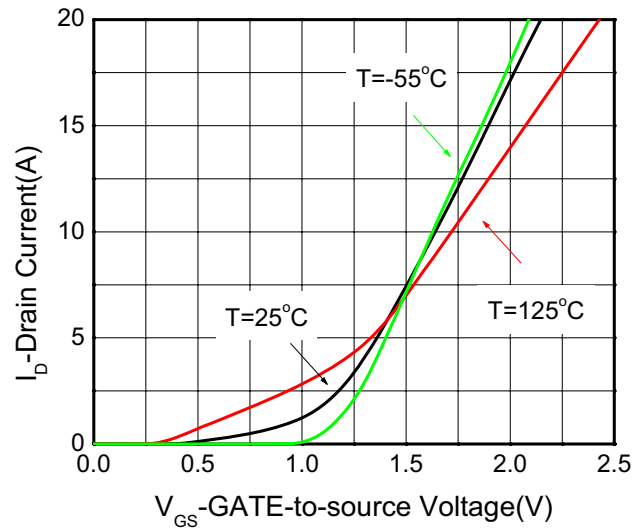
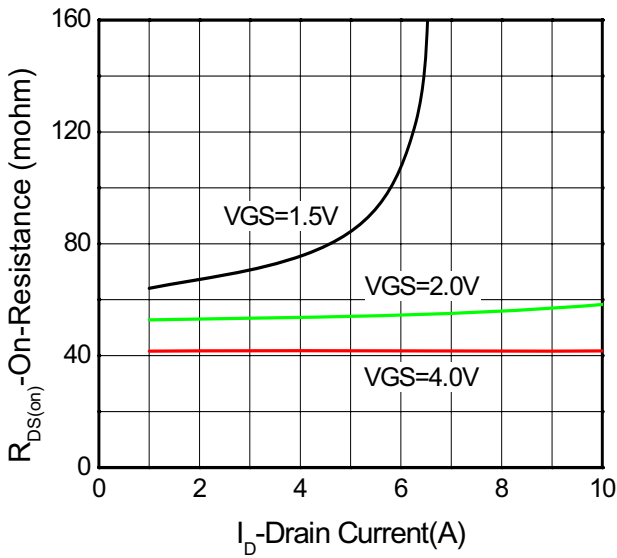
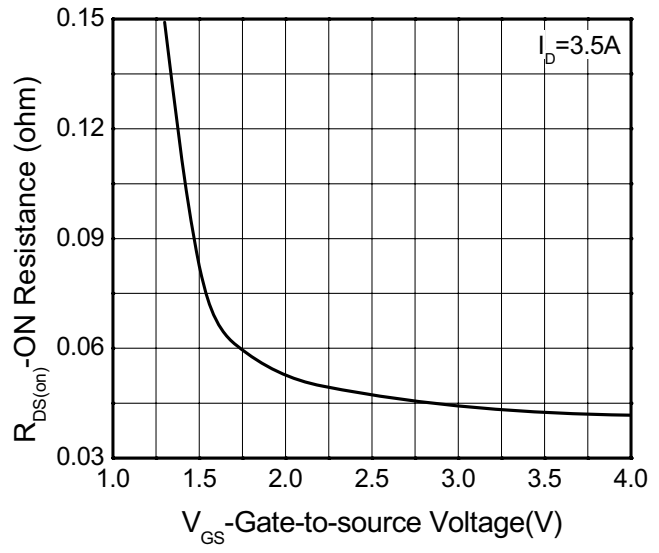
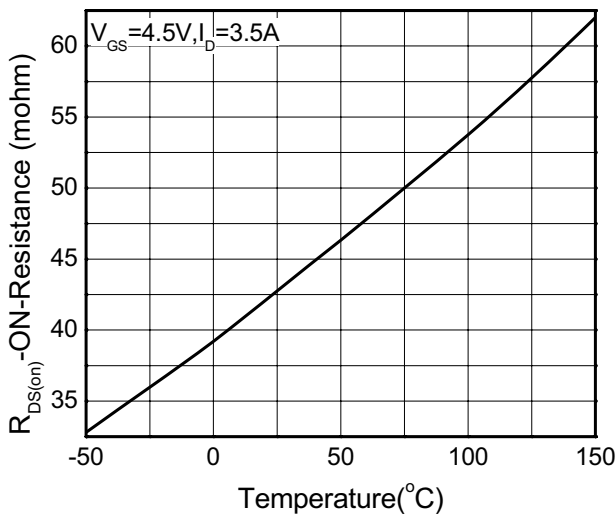
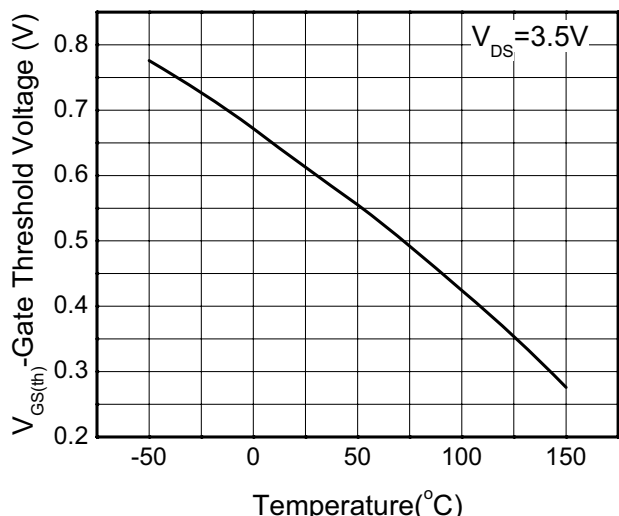
Typical Performance Graph

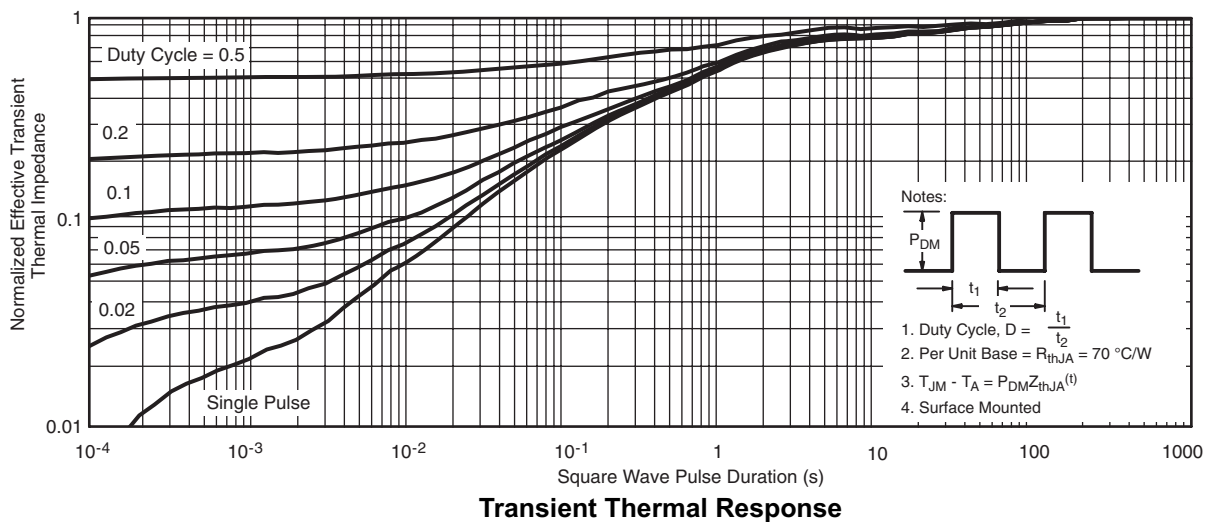
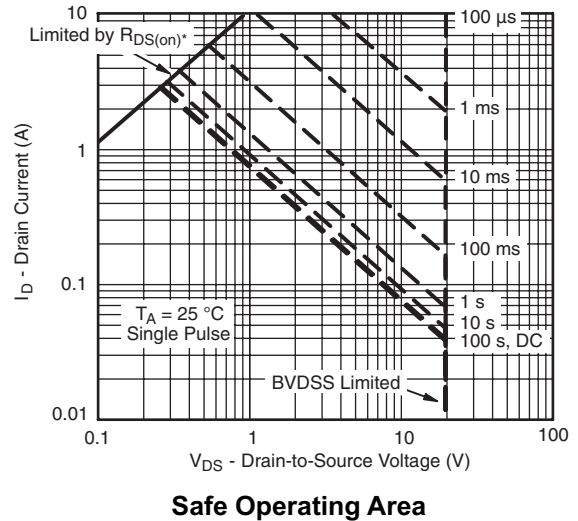
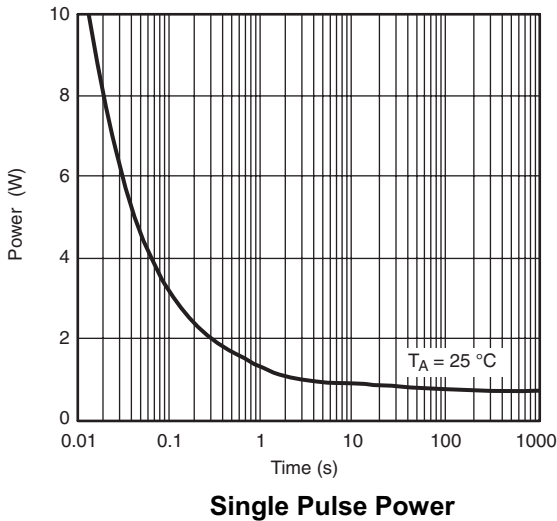
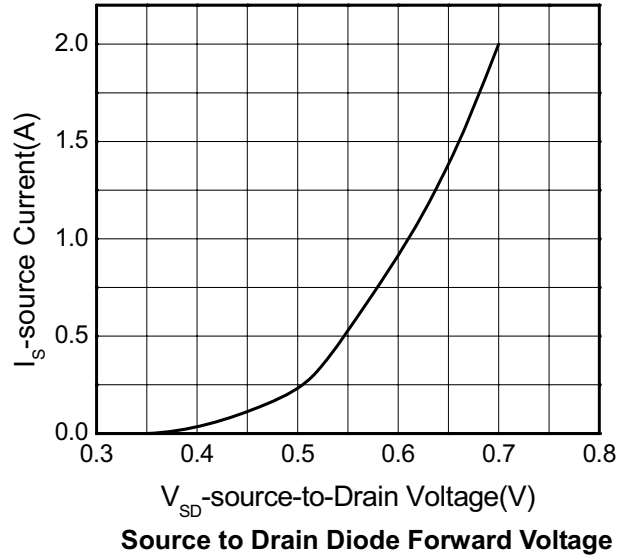
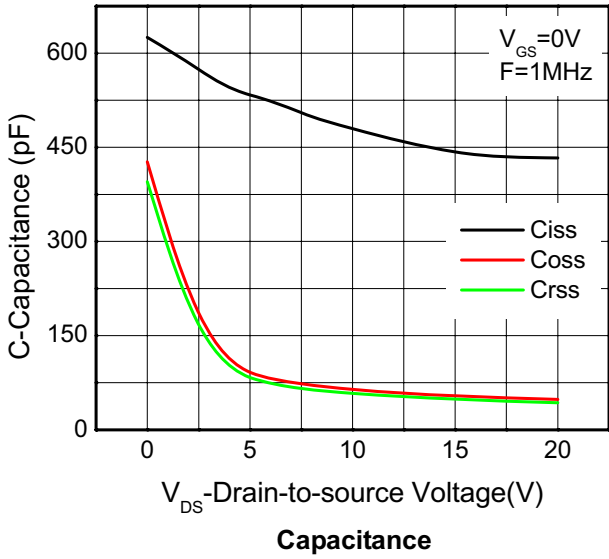
Output Characteristics

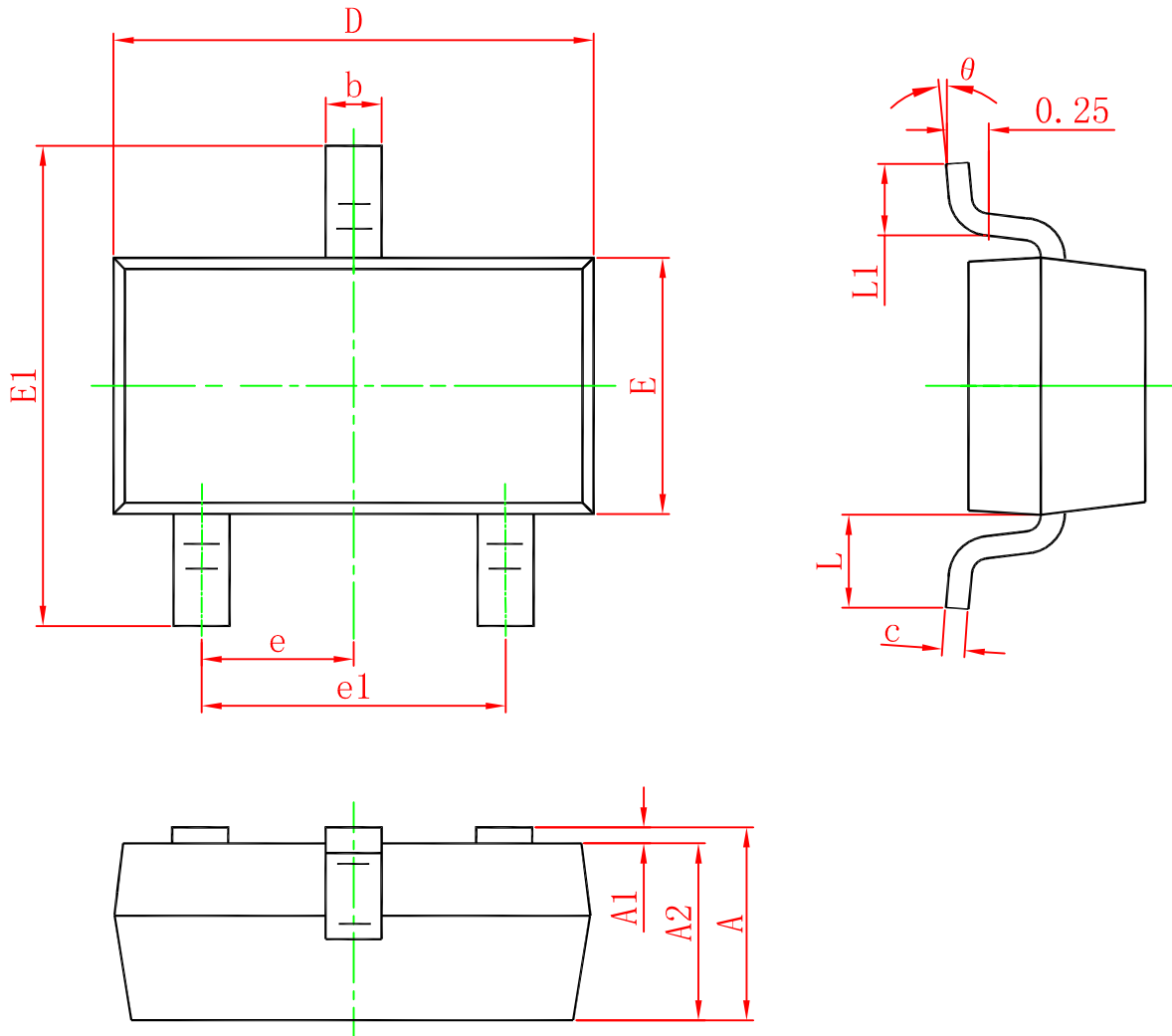
Transfer Characteristics

Rds(on) vs. Drain Current

Rds(on) vs. Gate to Source Voltage

Rds(on) vs. Junction Temperature

Threshold voltage vs. Temperature



Package Outline Dimension
SOT-23

Symbol	Dimensions In Millimeters	
	Min.	Max.
A	0.900	1.150
A1	0.000	0.100
A2	0.900	1.050
b	0.300	0.500
c	0.080	0.150
D	2.800	3.000
E	1.200	1.400
E1	2.250	2.550
e	0.950 (Typ.)	
e1	1.800	2.000
L	0.550 (Typ.)	
L1	0.300	0.500
θ	0°	8°