



# MBR2020 THRU MBR20100

## SCHOTTKY BARRIER RECTIFIER

Reverse Voltage - 20 to 100 Volts Forward Current - 20.0 Amperes

### TO-220AC

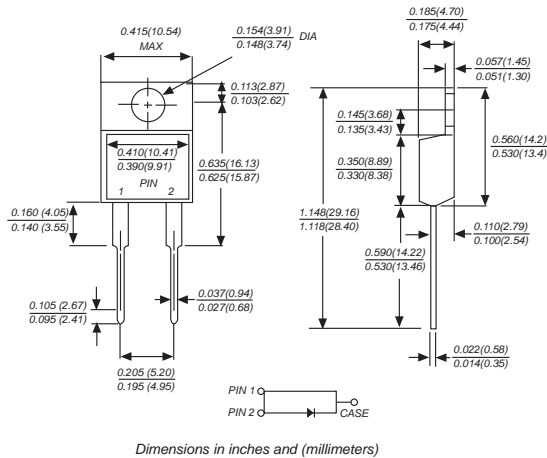

### FEATURES

- ◆ The plastic package carries Underwriters Laboratory Flammability Classification 94V-0
- ◆ Construction utilizes void-free molded plastic technique
- ◆ Low reverse leakage
- ◆ High forward surge current capability
- ◆ High temperature soldering guaranteed: 250°C, 0.25" (6.35mm) from case for 10 seconds

### MECHANICAL DATA

**Case:** TO-220AC molded plastic body  
**Terminals:** Leads solderable per MIL-STD-750, Method 2026  
**Polarity:** As marked  
**Mounting Position:** Any  
**Weight:** 0.064 ounce, 1.81 grams

### MAXIMUM RATINGS AND ELECTRICAL CHARACTERISTICS

Ratings at 25°C ambient temperature unless otherwise specified.  
 Single phase half-wave 60Hz, resistive or inductive load, for capacitive load current derate by 20%.

MDD Catalog Number	SYMBOLS	MBR 2020	MBR 2030	MBR 2040	MBR 2045	MBR 2050	MBR 2060	MBR 2070	MBR 2080	MBR 2090	MBR 20100	UNITS
Maximum repetitive peak reverse voltage	$V_{RRM}$	20	30	40	45	50	60	70	80	90	100	VOLTS
Maximum RMS voltage	$V_{RMS}$	14	21	28	32	35	42	49	56	63	70	VOLTS
Maximum DC blocking voltage	$V_{DC}$	20	30	40	45	50	60	70	80	90	100	VOLTS
Maximum average forward rectified current at $T_c$ (see fig.1)	$I_{AV}$	20.0										Amps
Peak forward surge current 8.3ms single half sine-wave superimposed on rated load (JEDEC Method)	$I_{FSM}$	150.0										Amps
Maximum instantaneous forward voltage at 10.0A	$V_F$	0.55			0.75			0.85			Volts	
Maximum DC reverse current at rated DC blocking voltage	$I_R$	1.0					15.0					mA
Typical junction capacitance (NOTE 1)	$C_J$	550					450					pF
Typical thermal resistance (NOTE 2)	$R_{\theta JC}$	2.0										°C/W
Operating junction temperature range	$T_J$	-50 to +125					-50 to +150					°C
Storage temperature range	$T_{STG}$	-50 to +150										°C

**Note:** 1. Measured at 1MHz and applied reverse voltage of 4.0V D.C.

2. Thermal resistance from junction to case



www.mikrocode.com

# RATINGS AND CHARACTERISTIC CURVES MBR2020 THRU MBR20100

AVERAGE FORWARD RECTIFIED CURRENT,  
AMPERES

FIG. 1- FORWARD CURRENT DERATING CURVE

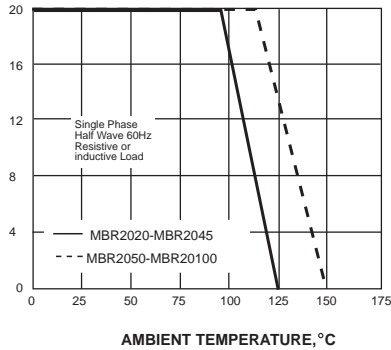

PEAK FORWARD SURGE CURRENT,  
AMPERES

FIG. 2-MAXIMUM NON-REPETITIVE PEAK FORWARD SURGE CURRENT

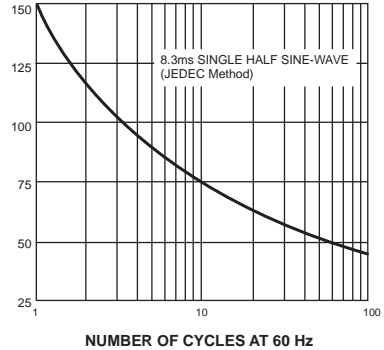
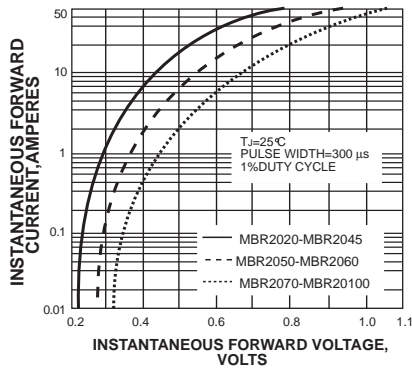
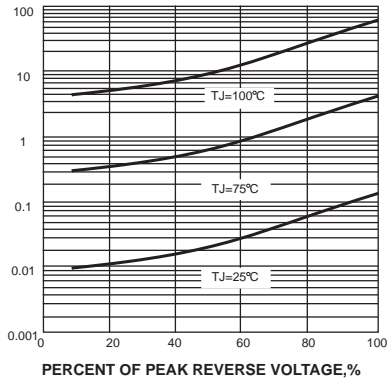

FIG. 3-TYPICAL INSTANTANEOUS FORWARD CHARACTERISTICS



INSTANTANEOUS REVERSE CURRENT,  
MILLIAMPERES

FIG. 4-TYPICAL REVERSE CHARACTERISTICS



JUNCTION CAPACITANCE, pF

FIG. 5-TYPICAL JUNCTION CAPACITANCE

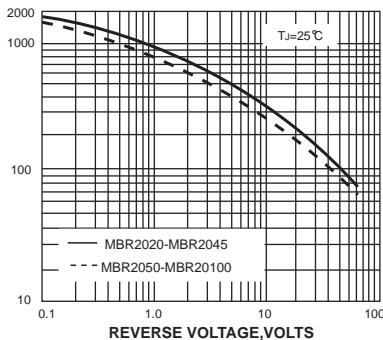

TRANSIENT THERMAL IMPEDANCE,  
°C/W

FIG. 6-TYPICAL TRANSIENT THERMAL IMPEDANCE

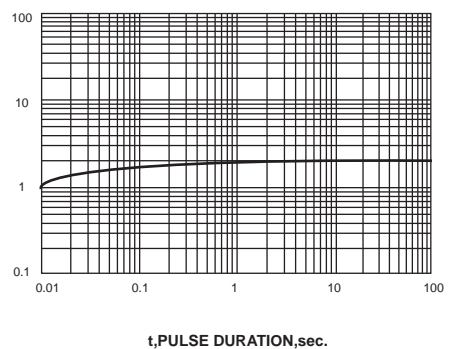

The cruve graph is for reference only, can't be the basis for judgment(曲线图仅供参考!)



www.microdiode.com