

TPS25942x/44x 2.7 V-18 V, 5-A eFuse Power MUX With Multiple Protection Modes

1 Features

- 2.7 V to 18 V Operating Voltage, 20 V (Maximum)
- 42-mΩ R_{ON} (Typical)
- 0.6 A to 5.3 A Adjustable Current Limit (±8%)
- IMON Current Indicator Output (±8%)
- 200-μA Operating I_Q (Typical)
- 15-μA Disabled I_Q (Typical)
- ±2% Overvoltage, Undervoltage Thresholds
- Reverse Current Blocking
- 1-μs Reverse Voltage Shutoff
- Programmable dV_o/dt Control
- Power Good and Fault Outputs
- Two Overcurrent Fault Response Options
 - TPS25942: I_(LIMIT) with Thermal Shutdown
 - TPS25944: 4 ms Fault Timer then Shutoff
- -40°C to +125°C Junction Temperature Range
- UL 2367 Recognized
 - File No. 169910
 - R_{ILIM} ≥ 20 kΩ (4.81 A Maximum)
- UL60950 Safe during Single Point Failure
 - Open-Short ILIM detection

2 Applications

- Power Path Management
- Redundant Power Supply Systems
- PCIe cards, NICs and RAID Systems
- USB Power Banks, Power MUXes
- SSDs and HDDs
- Tablets and Notebooks
- Adapter Power Devices
- PLCs, SS Relays and Fan Control

3 Description

The TPS25942, TPS25944 eFuse Power MUX is a compact, feature rich power management device with a full suite of protection functions. The wide operating range allows control of many popular DC bus voltages. Integrated back-to-back FETs provide bidirectional current control making the device well suited for power muxing and systems with multiple power sources.

Load, source and device protection are provided with many programmable features. Thresholds for undervoltage, overvoltage, overcurrent, dV_o/dt ramp rate, power good, and in-rush current protection are all programmable to suit specific system requirements. For system status monitoring and downstream load control, the device provides PGOOD, FLT and precise current monitor output.

The TPS25942, TPS25944 monitor V_(IN) and V_(OUT) to provide true reverse blocking from output when V_(IN) < (V_(OUT) - 10 mV). The device can be configured to assign Main/Auxiliary supply priority using the FLT and DMODE pins.

Device Information⁽¹⁾

PART NUMBER ⁽²⁾	PACKAGE	BODY SIZE (NOM)
TPS25942L	WQFN (20)	3.00 mm x 4.00 mm
TPS25942A		
TPS25944L		
TPS25944A		

(1) For all available packages, see the orderable addendum at the end of the datasheet

(2) TPS2594xL = Latched, TPS2594xA = Auto Retry

Simplified Schematic

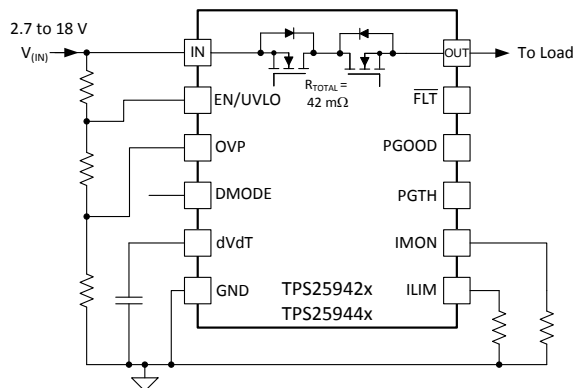

Failover of V_(MAIN) = 12 V to V_(AUX) = 12.3 V Using Diode Mode Control

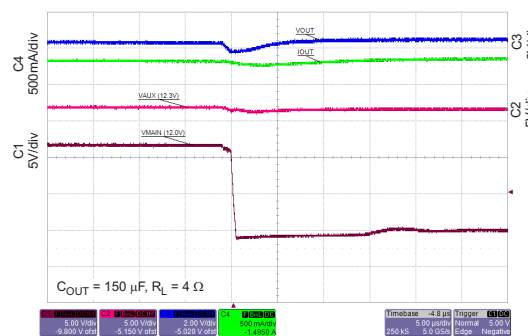

Table of Contents

1 Features	1	10 Application and Implementation	29
2 Applications	1	10.1 Application Information	29
3 Description	1	10.2 Typical Application	29
4 Revision History	2	10.3 System Examples	37
5 Device Comparison Table	4	11 Power Supply Recommendations	44
6 Pin Configuration and Functions	4	11.1 Transient Protection	44
7 Specifications	6	11.2 Output Short-Circuit Measurements	45
7.1 Absolute Maximum Ratings	6	12 Layout	46
7.2 ESD Ratings	6	12.1 Layout Guidelines	46
7.3 Recommended Operating Conditions	6	12.2 Layout Example	47
7.4 Thermal Information	6	13 Device and Documentation Support	48
7.5 Electrical Characteristics	7	13.1 Device Support	48
7.6 Timing Requirements	9	13.2 Documentation Support	48
7.7 Typical Characteristics	10	13.3 Related Links	48
8 Parameter Measurement Information	18	13.4 Receiving Notification of Documentation Updates	48
9 Detailed Description	19	13.5 Community Resources	48
9.1 Overview	19	13.6 Trademarks	48
9.2 Functional Block Diagram	20	13.7 Electrostatic Discharge Caution	48
9.3 Feature Description	22	13.8 Glossary	49
9.4 Device Functional Modes	26	14 Mechanical, Packaging, and Orderable Information	49

4 Revision History

Changes from Revision C (January 2017) to Revision D	Page
• Added section 9.3.5 Reverse Current Protection to Feature Description	25

Changes from Revision B (October 2017) to Revision C	Page
• Changed internal ramp rate of 12 V/ms for output to 30 V/ms in the Hot Plug-In and In-Rush Current Control section.....	23

Changes from Revision A (March 2015) to Revision B	Page
• Changed Figure 49 : Added Logic Inversion	21

Changes from Original (June 2014) to Revision A	Page
• Changed Features From: UL2367 Recognition Pending To: UL 2367 Recognized, $R_{ILIM} \geq 20 \text{ k}\Omega$ (4.81 A max), File No. 169910	1
• Changed text in the Description From: $\overline{\text{FLT}}$ and $\overline{\text{ENBLK}}$ pins To: $\overline{\text{FLT}}$ and DMODE pins.....	1
• Deleted Note "Product Preview" from the Device Information table	1
• Changed Pin 1 From $\overline{\text{ENBLK}}$ To: DMODE throughout the data sheet	4
• Changed $\overline{\text{ENBLK}}$ To: DMODE in the Pin Functions table and updated the DESCRIPTION	4
• Moved the Storage Temperature From the Handling Ratings table To Absolute Maximum Ratings table	6
• Changed the Handling Ratings table To: ESD Ratings table	6
• Changed DIODE MODE INPUT ($\overline{\text{ENBLK}}$): ACTIVE LOW To: DIODE MODE INPUT (DMODE): ACTIVE HIGH in the Electrical Characteristics	7
• Added Test Condition to $I_{(LIM)}$: " $R_{(LIM)} = 20 \text{ k}\Omega$ " in the Electrical Characteristics	8
• Changed Test Condition in $I_{(LIM)}$ From: " $\overline{\text{ENBLK}} = \text{High}$; Diode Mode" To: "DMODE = High; Non-ideal Diode Mode" in the Electrical Characteristics	8

• Changed "DIODE MODE INPUT: ACTIVE LOW ($\overline{\text{ENBLK}}$)" To: DIODE MODE INPUT: ACTIVE HIGH (DMODE)" in the Timing Requirements	9
• Changed Figure 22	12
• Added condition $R_{(\text{ILIM})} = 17.8 \text{ K}\Omega$ to Figure 39 and Figure 40	15
• Changed Figure 43 . Added Figure 44 , Figure 45 , and Figure 46	16
• Changed Figure 48 : $\overline{\text{ENBLK}}$ To: DMODE and Diode Mode To: Non-Ideal Diode Mode	20
• Changed Figure 49 : $\overline{\text{ENBLK}}$ To: DMODE and Diode Mode To Non-Ideal Diode Mode	21
• Changed Equation 6 to include $I_{(\text{MON_OS})}$	25
• Change text in Diode Mode From: " $\overline{\text{ENBLK}}$...active low terminal" To: "DMODE ...active high terminal".....	26
• Changed text in the last sentence of Diode Mode From: "In this mode, the overload current..." To:"In this mode, the circuit breaker functionality.."	26
• Added the NOTE to Application and Implementation	29
• Added Note A to Figure 60	33
• Changed Equation 37 From: $V_{(\text{IN})} \times I_{(\text{LOAD})}$ To: $V_{(\text{IN})} + I_{(\text{LOAD})}$	44

5 Device Comparison Table

DEVICE	T _J	OPERATION ⁽¹⁾	TYPE
TPS25942A	-40°C to +125°C	Current limiter	Auto retry
TPS25942L		Current limiter	Latched
TPS25944A		Circuit breaker	Auto retry
TPS25944L		Circuit breaker	Latched

(1) See the [Operational Differences Between the TPS25942 and TPS25944](#) section for detailed information.

6 Pin Configuration and Functions

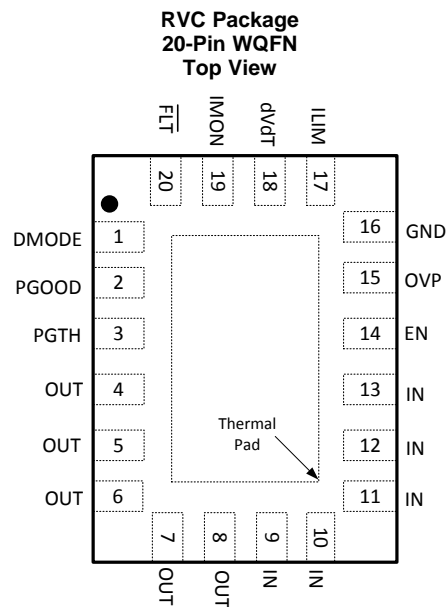

Pin Functions

PIN		I/O	DESCRIPTION
NO.	NAME		
1	DMODE	I	Diode Mode control pin. A high at this pin activates the non-ideal diode mode
2	PGOOD	O	Active High. A high indicates PGTH has crossed the threshold value. It is an open drain output
3	PGTH	I	Positive input of PGOOD comparator
4	OUT	O	Power output of the device
5			
6			
7			
8	IN	I	Power input and supply voltage
9			
10			
11			
12	EN/UVLO	I	Input for setting programmable undervoltage lockout threshold. An undervoltage event opens internal FET and assert FLT to indicate power-failure. When pulled to GND, resets the fault latch in TPS25942L, TPS25944L
13			
14	OVP	I	Input for setting programmable overvoltage protection threshold. An overvoltage event opens the internal FET and assert FLT to indicate overvoltage
15	GND	—	Ground
16			

Pin Functions (continued)

PIN		I/O	DESCRIPTION
NO.	NAME		
17	ILIM	I/O	A resistor from this pin to GND sets the overload and short-circuit current limit
18	dVdT	I/O	A capacitor from this pin to GND sets the ramp rate of output voltage
19	IMON	O	This pin sources a scaled down ratio of current through the internal FET. A resistor from this pin to GND converts current to proportional voltage, used as analog current monitor
20	$\overline{\text{FLT}}$	O	Fault event indicator, goes low to indicate fault condition due to undervoltage, pvervoltage, reverse voltage, circuit breaker timeout (TPS25944 only) and thermal shutdown events. It is an open drain output
—	PowerPAD™	—	The GND terminal must be connected to the exposed PowerPAD. This PowerPAD must be connected to a PCB ground plane using multiple vias for good thermal performance

7 Specifications

7.1 Absolute Maximum Ratings

 over operating temperature range (unless otherwise noted) ⁽¹⁾

		MIN	MAX	UNIT
Input voltage	IN, OUT, PGTH, PGOOD, EN, OVP, DMODE, $\overline{\text{FLT}}$	-0.3	20	V
	IN (10-ms transient)		22	
	dVdT, ILIM	-0.3	3.6	
	IMON	-0.3	7	
Sink current	PGOOD, $\overline{\text{FLT}}$, dVdT		10	mA
Source current	dVdT, ILIM, IMON	Internally Limited		
Continuous power dissipation		See the Thermal Information		
T _J	Maximum junction temperature	-40	150	°C
T _{stg}	Storage temperature	-65	150	°C

- (1) Stresses beyond those listed under *Absolute Maximum Ratings* may cause permanent damage to the device. These are stress ratings only, which do not imply functional operation of the device at these or any other conditions beyond those indicated under *Recommended Operating Conditions*. Exposure to absolute-maximum-rated conditions for extended periods may affect device reliability.

7.2 ESD Ratings

			VALUE	UNIT
V _{ESD}	Electrostatic discharge	Human body model (HBM), per ANSI/ESDA/JEDEC JS-001s ⁽¹⁾	±2000	V
		Charged device model (CDM), per JEDEC specification JESD22-C101 ⁽²⁾	±500	

- (1) JEDEC document JEP155 states that 500-V HBM allows safe manufacturing with a standard ESD control process.

- (2) JEDEC document JEP157 states that 250-V CDM allows safe manufacturing with a standard ESD control process.

7.3 Recommended Operating Conditions

over operating free-air temperature range (unless otherwise noted)

		MIN	NOM	MAX	UNIT
Input voltage	IN	2.7		18	V
	EN, OVP, DMODE, OUT, PGTH, PGOOD, $\overline{\text{FLT}}$	0		18	
	dVdT, ILIM	0		3	
	IMON	0		6	
Resistance	ILIM	16.9		150	kΩ
	IMON	1			
External capacitance	OUT	0.1			μF
	dVdT			470	nF
T _J	Operating junction temperature	-40	25	125	°C

7.4 Thermal Information

THERMAL METRIC ⁽¹⁾		TPS25942 TPS25944	UNIT
		RVC (WQFN)	
		20 PINS	
R _{θJA}	Junction-to-ambient thermal resistance	38.1	°C/W
R _{θJTop}	Junction-to-case (top) thermal resistance	40.5	°C/W
R _{θJB}	Junction-to-board thermal resistance	13.6	°C/W
ψ _{JT}	Junction-to-top characterization parameter	0.6	°C/W
ψ _{JB}	Junction-to-board characterization parameter	13.7	°C/W

- (1) For more information about traditional and new thermal metrics, see the [Semiconductor and IC Package Thermal Metrics](#) application report.

Thermal Information (continued)

THERMAL METRIC ⁽¹⁾		TPS25942 TPS25944	UNIT
		RVC (WQFN)	
		20 PINS	
$R_{\theta JCbot}$	Junction-to-case (bottom) thermal resistance	3.4	°C/W

7.5 Electrical Characteristics

Conditions are $-40^{\circ}\text{C} \leq T_J = T_A \leq +125^{\circ}\text{C}$, $2.7\text{ V} \leq V_{(IN)} \leq 18\text{ V}$, $V_{(EN/UVLO)} = 2\text{ V}$, $V_{(OVP)} = V_{(DMODE)} = V_{(PGTH)} = 0\text{ V}$, $R_{(LIM)} = 150\text{ k}\Omega$, $C_{(OUT)} = 1\text{ }\mu\text{F}$, $C_{(dVdT)} = \text{OPEN}$, $\text{PGOOD} = \overline{\text{FLT}} = \text{IMON} = \text{OPEN}$. Positive current into terminals. All voltages referenced to GND (unless otherwise noted)

PARAMETER		TEST CONDITIONS	MIN	TYP	MAX	UNIT
SUPPLY VOLTAGE AND INTERNAL UNDERVOLTAGE LOCKOUT						
$V_{(IN)}$	Operating input voltage		2.7		18	V
$V_{(UVR)}$	Internal UVLO threshold, rising		2.2	2.3	2.4	V
$V_{(UVRhys)}$	Internal UVLO hysteresis		105	116	125	mV
$I_{Q(ON)}$	Supply current, enabled	$V_{(EN/UVLO)} = 2\text{ V}$, $V_{(IN)} = 3\text{ V}$	140	210	300	μA
		$V_{(EN/UVLO)} = 2\text{ V}$, $V_{(IN)} = 12\text{ V}$	140	199	260	
		$V_{(EN/UVLO)} = 2\text{ V}$, $V_{(IN)} = 18\text{ V}$	140	202	270	
$I_{Q(OFF)}$	Supply current, disabled	$V_{(EN/UVLO)} = 0\text{ V}$, $V_{(IN)} = 3\text{ V}$	4	8.6	15	μA
		$V_{(EN/UVLO)} = 0\text{ V}$, $V_{(IN)} = 12\text{ V}$	6	15	20	
		$V_{(EN/UVLO)} = 0\text{ V}$, $V_{(IN)} = 18\text{ V}$	8	18.5	25	
ENABLE AND UNDERVOLTAGE LOCKOUT (EN/UVLO) INPUT						
$V_{(ENR)}$	EN/UVLO threshold voltage, rising		0.97	0.99	1.01	V
$V_{(ENF)}$	EN/UVLO threshold voltage, falling		0.9	0.92	0.94	V
$V_{(SHUTF)}$	EN threshold voltage for Low I_Q shutdown, falling		0.3	0.47	0.63	V
$V_{(SHUTFhys)}$	EN hysteresis for low I_Q shutdown, hysteresis ⁽¹⁾			66		mV
I_{EN}	EN input leakage current	$0\text{ V} \leq V_{(EN/UVLO)} \leq 18\text{ V}$	-100	0	100	nA
OVER VOLTAGE PROTECTION (OVP) INPUT						
$V_{(OVPR)}$	Overvoltage threshold voltage, rising		0.97	0.99	1.01	V
$V_{(OVPF)}$	Overvoltage threshold voltage, falling		0.9	0.92	0.94	V
$I_{(OVP)}$	OVP input leakage current	$0\text{ V} \leq V_{(OVP)} \leq 5\text{ V}$	-100	0	100	nA
DIODE MODE INPUT (DMODE)—ACTIVE HIGH						
$V_{(DMODE)}$	DMODE threshold voltage, rising		1.6	1.85	2	V
	DMODE threshold voltage, falling		0.8	0.96	1.1	V
$I_{(DMODE)}$	DMODE input leakage current	$0.2\text{ V} \leq V_{(DMODE)} \leq 18\text{ V}$	0.6	1	1.25	μA
OUTPUT RAMP CONTROL (dVdT)						
$I_{(dVdT)}$	dVdT charging current	$V_{(dVdT)} = 0\text{ V}$	0.85	1	1.15	μA
$R_{(dVdT)}$	dVdT discharging resistance	$\text{EN/UVLO} = 0\text{ V}$, $I_{(dVdT)} = 10\text{ mA}$ sinking		16	24	Ω
$V_{(dVdTmax)}$	dVdT maximum capacitor voltage		2.6	2.88	3.1	V
$\text{GAIN}_{(dVdT)}$	dVdT to OUT gain	$\Delta V_{(OUT)}/\Delta V_{(dVdT)}$	11.65	11.9	12.05	V/V
CURRENT LIMIT PROGRAMMING (I_{LIM})						
$V_{(LIM)}$	ILIM bias voltage			0.87		V

(1) These parameters are provided for reference only and do not constitute part of TI's published device specifications for purposes of TI's product warranty.

Electrical Characteristics (continued)

Conditions are $-40^{\circ}\text{C} \leq T_J = T_A \leq +125^{\circ}\text{C}$, $2.7\text{ V} \leq V_{(IN)} \leq 18\text{ V}$, $V_{(EN/UVLO)} = 2\text{ V}$, $V_{(OVP)} = V_{(DMODE)} = V_{(PGTH)} = 0\text{ V}$, $R_{(ILIM)} = 150\text{ k}\Omega$, $C_{(OUT)} = 1\text{ }\mu\text{F}$, $C_{(dVdT)} = \text{OPEN}$, $\overline{\text{FLT}} = \text{IMON} = \text{OPEN}$. Positive current into terminals. All voltages referenced to GND (unless otherwise noted)

PARAMETER	TEST CONDITIONS	MIN	TYP	MAX	UNIT
$I_{(LIM)}$ Current limit $I_{(LIM)}$ for TPS25942 ⁽²⁾ $I_{(FAULT)}$ for TPS25944 ⁽²⁾⁽³⁾	$R_{(ILIM)} = 150\text{ k}\Omega$, $(V_{(IN)} - V_{(OUT)}) = 1\text{ V}$	0.53	0.58	0.63	A
	$R_{(ILIM)} = 88.7\text{ k}\Omega$, $(V_{(IN)} - V_{(OUT)}) = 1\text{ V}$	0.9	0.99	1.07	
	$R_{(ILIM)} = 42.2\text{ k}\Omega$, $(V_{(IN)} - V_{(OUT)}) = 1\text{ V}$	1.92	2.08	2.25	
	$R_{(ILIM)} = 24.9\text{ k}\Omega$, $(V_{(IN)} - V_{(OUT)}) = 1\text{ V}$	3.25	3.53	3.81	
	$R_{(ILIM)} = 20\text{ k}\Omega$, $(V_{(IN)} - V_{(OUT)}) = 1\text{ V}$	4.09	4.45	4.81	
	$R_{(ILIM)} = 16.9\text{ k}\Omega$, $(V_{(IN)} - V_{(OUT)}) = 1\text{ V}$	4.78	5.2	5.62	
	$R_{(ILIM)} = \text{OPEN}$, open resistor current limit (single point failure test: UL60950)	0.35	0.45	0.55	
	$R_{(ILIM)} = \text{SHORT}$, shorted resistor current limit (single point failure test: UL60950)	0.55	0.67	0.8	
$I_{(OS)}$ Short-circuit current limit	$R_{(ILIM)} = 42.2\text{ k}\Omega$, $V_{(VIN)} = 12\text{ V}$, $(V_{(IN)} - V_{(OUT)}) = 5\text{ V}$	1.91	2.07	2.24	A
	$R_{(ILIM)} = 24.9\text{ k}\Omega$, $V_{(VIN)} = 12\text{ V}$, $(V_{(IN)} - V_{(OUT)}) = 5\text{ V}$	3.21	3.49	3.77	
	$R_{(ILIM)} = 16.9\text{ k}\Omega$, $V_{(VIN)} = 12\text{ V}$, $(V_{(IN)} - V_{(OUT)}) = 5\text{ V}$, $-40^{\circ}\text{C} \leq T_J \leq +85^{\circ}\text{C}$	4.7	5.11	5.52	
$I_{(FASTRIP)}$ Fast-trip comparator threshold ⁽¹⁾⁽²⁾			$1.5 \times I_{(LIM)} + 0.375$		A
CURRENT MONITOR OUTPUT (IMON)					
$GAIN_{(IMON)}$ Gain factor $I_{(IMON)}/I_{(OUT)}$	$1\text{ A} \leq I_{(OUT)} \leq 5\text{ A}$	47.78	52.3	57.23	$\mu\text{A/A}$
MOSFET—POWER SWITCH					
R_{ON} IN to OUT - ON resistance	$1\text{ A} \leq I_{(OUT)} \leq 5\text{ A}$, $T_J = 25^{\circ}\text{C}$	34	42	49	m Ω
	$1\text{ A} \leq I_{(OUT)} \leq 5\text{ A}$, $-40^{\circ}\text{C} \leq T_J \leq +85^{\circ}\text{C}$	26	42	58	
	$1\text{ A} \leq I_{(OUT)} \leq 5\text{ A}$, $-40^{\circ}\text{C} \leq T_J \leq +125^{\circ}\text{C}$	26	42	64	
PASS FET OUTPUT (OUT)					
$I_{(kg)(OUT)}$ OUT leakage current in off state	$V_{(IN)} = 18\text{ V}$, $V_{(EN/UVLO)} = 0\text{ V}$, $V_{(OUT)} = 0\text{ V}$ (sourcing)	-2	0	2	μA
	$V_{(IN)} = 2.7\text{ V}$, $V_{(EN/UVLO)} = 0\text{ V}$, $V_{(OUT)} = 18\text{ V}$ (sinking)	6	13	20	
$V_{(REVTH)}$ $V_{(IN)} - V_{(OUT)}$ threshold for reverse protection comparator, falling		-15	-9.3	-3	mV
$V_{(FWDTH)}$ $V_{(IN)} - V_{(OUT)}$ threshold for reverse protection comparator, rising		86	100	114	mV
FAULT FLAG ($\overline{\text{FLT}}$)—ACTIVE LOW					
$R_{(\overline{\text{FLT}})}$ $\overline{\text{FLT}}$ internal pull-down resistance	$V_{(OVP)} = 2\text{ V}$, $I_{(\overline{\text{FLT}})} = 5\text{ mA}$ sinking	10	18	30	Ω
$I_{(\overline{\text{FLT}})}$ $\overline{\text{FLT}}$ input leakage current	$0\text{ V} \leq V_{(\overline{\text{FLT}})} \leq 18\text{ V}$	-1	0	1	μA
POSITIVE INPUT for POWER-GOOD COMPARATOR (PGTH)					
$V_{(PGTHR)}$ PGTH threshold voltage, rising		0.97	0.99	1.01	V
$V_{(PGTHF)}$ PGTH threshold voltage, falling		0.9	0.92	0.94	V
$I_{(PGTH)}$ PGTH input leakage current	$0\text{ V} \leq V_{(PGTH)} \leq 18\text{ V}$	-100	0	100	nA
POWER-GOOD COMPARATOR OUTPUT (PGOOD): ACTIVE HIGH					
$R_{(PGOOD)}$ PGOOD internal pull-down resistance	$V_{(PGTH)} = 0\text{ V}$, $I_{(PGOOD)} = 5\text{ mA}$ sinking	10	20	35	Ω
$I_{(PGOOD)}$ PGOOD input leakage current	$0\text{ V} \leq V_{(PGOOD)} \leq 18\text{ V}$	-1	0	1	μA
THERMAL SHUT DOWN (TSD)					
$T_{(TSD)}$ TSD threshold ⁽¹⁾			160		$^{\circ}\text{C}$
$T_{(TSDhys)}$ TSD hysteresis ⁽¹⁾			12		$^{\circ}\text{C}$
Thermal fault: (latched or auto-retry)	TPS25942L, TPS25944L	Latched			
	TPS25942A, TPS25944A	Auto-retry			

(2) Pulse-testing techniques maintain junction temperature close to ambient temperature. Thermal effects must be taken into account separately.

(3) The TPS25942 limits current to the programmed $I_{(LIM)}$ level. TPS25944 does not limit current but runs the fault timer when $I_{(LOAD)} > I_{(LIM)}$.

7.6 Timing Requirements

Conditions are $-40^{\circ}\text{C} \leq T_J = T_A \leq +125^{\circ}\text{C}$, $2.7\text{ V} \leq V_{(IN)} \leq 18\text{ V}$, $V_{(EN/UVLO)} = 2\text{ V}$, $V_{(OVP)} = V_{(DMODE)} = V_{(PGTH)} = 0\text{ V}$, $R_{(ILIM)} = 150\text{ k}\Omega$, $C_{(OUT)} = 1\text{ }\mu\text{F}$, $C_{(dVdT)} = \text{OPEN}$, $\text{PGOOD} = \overline{\text{FLT}} = \text{IMON} = \text{OPEN}$. Positive current into terminals. All voltages referenced to GND (unless otherwise noted). See [Figure 47](#) for timing diagrams.

PARAMETER		TEST CONDITIONS	MIN	TYP	MAX	UNIT
ENABLE AND UVLO INPUT						
$t_{\text{ON(dly)}}$	EN turnon delay	EN/UVLO \uparrow (100 mV above $V_{(ENR)}$) to $V_{(OUT)} = 100\text{ mV}$, $C_{(dVdT)} < 0.8\text{ nF}$		220		μs
		EN/UVLO \uparrow (100 mV above $V_{(ENR)}$) to $V_{(OUT)} = 100\text{ mV}$, $C_{(dVdT)} \geq 0.8\text{ nF}$, see $C_{(dVdT)}$ in nF		$100 + 150 \times C_{(dVdT)}$		μs
$t_{\text{OFF(dly)}}$	EN turnoff delay	EN/UVLO \downarrow (100 mV below $V_{(ENF)}$) to $\overline{\text{FLT}}\downarrow$		2		μs
OVERVOLTAGE PROTECTION INPUT (OVP)						
$t_{\text{OVP(dly)}}$	OVP disable delay	OVP \uparrow (100 mV above $V_{(OVPR)}$) to $\overline{\text{FLT}}\downarrow$		2		μs
DIODE MODE INPUT: ACTIVE HIGH (DMODE)						
t_{DMODE}	DMODE turnon delay	DMODE \downarrow to $(V_{(IN)} - V_{(OUT)}) \leq 200\text{ mV}$, with 1 A resistive load at OUT		2		μs
	DMODE turnoff delay	DMODE \uparrow to $(V_{(IN)} - V_{(OUT)}) > 200\text{ mV}$, 1 A resistive load at OUT		220		ns
OUTPUT RAMP CONTROL (dVdT)						
t_{dVdT}	Output ramp time	EN/UVLO \uparrow to $V_{(OUT)} = 4.5\text{ V}$, with $C_{(dVdT)} = \text{open}$		0.12		ms
		EN/UVLO \uparrow to $V_{(OUT)} = 11\text{ V}$, with $C_{(dVdT)} = \text{open}$	0.25	0.37	0.5	
		EN/UVLO \uparrow to $V_{(OUT)} = 11\text{ V}$, with $C_{(dVdT)} = 1\text{ nF}$		0.97		
CURRENT LIMIT						
$t_{\text{FASTRIP(dly)}}$	Fast-trip comparator delay	$I_{(OUT)} > I_{(FASTRIP)}$		200		ns
REVERSE PROTECTION COMPARATOR						
$t_{\text{REV(dly)}}$	Reverse protection comparator delay	$(V_{(IN)} - V_{(OUT)})\downarrow$ (1 mV overdrive below $V_{(REVTH)}$) to $\overline{\text{FLT}}\downarrow$		10		μs
		$(V_{(IN)} - V_{(OUT)})\downarrow$ (10 mV overdrive below $V_{(REVTH)}$) to $\overline{\text{FLT}}\downarrow$		1		
$t_{\text{FWD(dly)}}$		$(V_{(IN)} - V_{(OUT)})\uparrow$ (10 mV overdrive above $V_{(FWDTH)}$) to $\overline{\text{FLT}}\uparrow$		3.1		
POWER-GOOD COMPARATOR OUTPUT (PGOOD): ACTIVE HIGH						
t_{PGOODR}	PGOOD delay (de-glitch) time	TPS25942: rising edge	0.42	0.54	0.66	ms
		TPS25944: rising edge		4		
t_{PGOODF}		TPS25942 and TPS25944: falling edge		10		μs
FAULT FLAG ($\overline{\text{FLT}}$)						
$t_{\text{CB(dly)}}$	$\overline{\text{FLT}}$ assertion delay in circuit breaker mode	TPS25944 only; delay from $I_{(OUT)} > I_{(LIM)}$ to $\overline{\text{FLT}}\downarrow$ (and internal FET turned off)		4		ms
$t_{\text{CB(Retrydly)}}$	Retry delay in circuit breaker mode	TPS25944A only; circuit breaker fault asserted, delay from to $\overline{\text{FLT}}\downarrow$ to $\overline{\text{FLT}}\uparrow$ edge		128		ms
THERMAL SHUT DOWN (TSD)						
	Retry delay in TSD	TPS25942A and TPS25944A only		128		ms

7.7 Typical Characteristics

Conditions are $-40^{\circ}\text{C} \leq T_J = T_A \leq +125^{\circ}\text{C}$, $V_{(IN)} = 12\text{ V}$, $V_{(EN/UVLO)} = 2\text{ V}$, $V_{(OVP)} = V_{(DMODE)} = V_{(PGTH)} = 0\text{ V}$, $R_{(ILIM)} = 150\text{ k}\Omega$, $C_{(OUT)} = 1\text{ }\mu\text{F}$, $C_{(dVdT)} = \text{OPEN}$, $\text{PGOOD} = \text{FLT} = \text{IMON} = \text{OPEN}$. (unless stated otherwise)

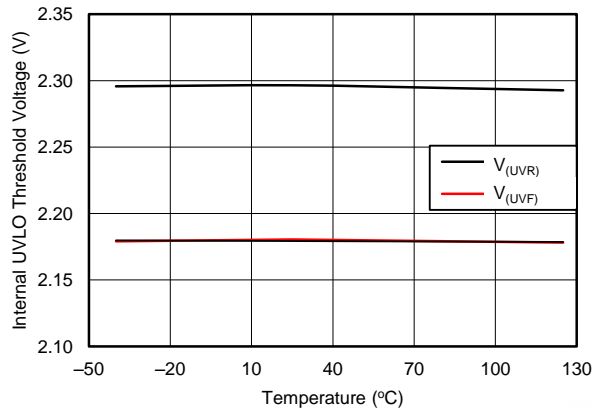

Figure 1. Internal UVLO Threshold Voltage vs Temperature

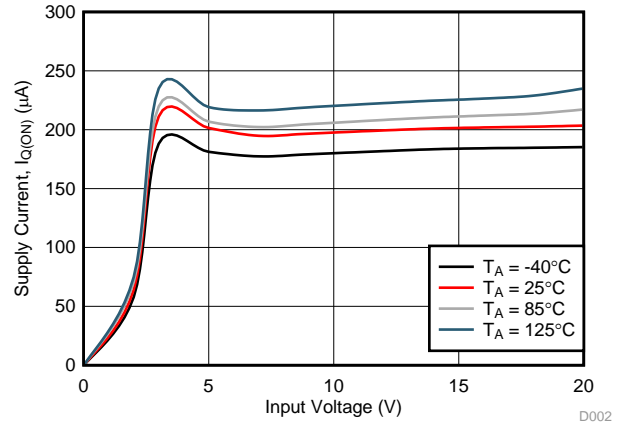

Figure 2. Input Supply Current vs Supply Voltage During Normal Operation

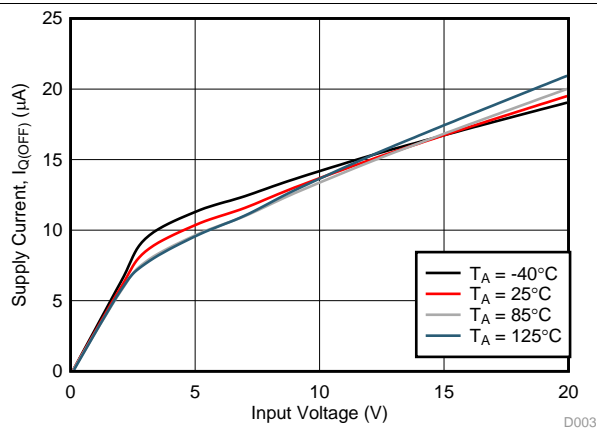

Figure 3. Input Supply Current vs Supply Voltage at Shutdown

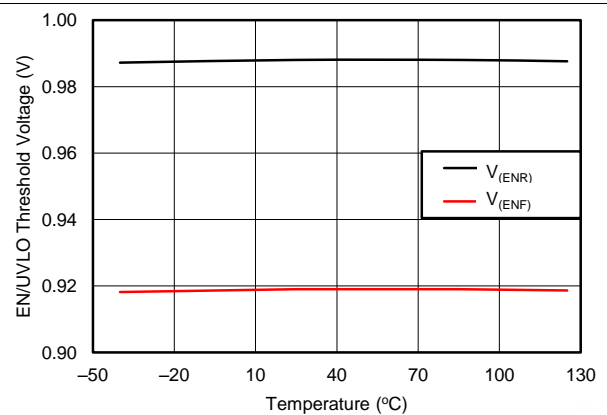

Figure 4. EN Threshold Voltage vs Temperature

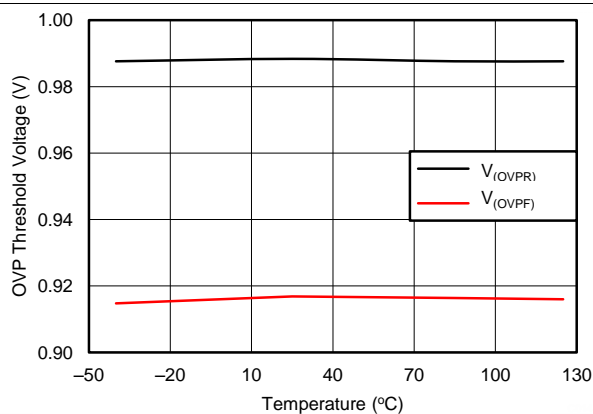

Figure 5. OVP Threshold Voltage vs Temperature

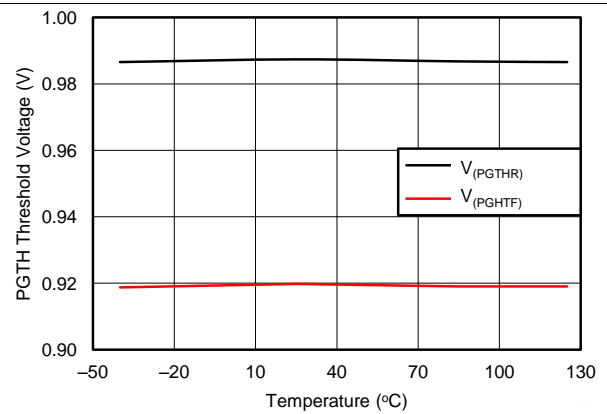

Figure 6. PGTH Threshold Voltage vs Temperature

Typical Characteristics (continued)

Conditions are $-40^{\circ}\text{C} \leq T_J = T_A \leq +125^{\circ}\text{C}$, $V_{(IN)} = 12\text{ V}$, $V_{(EN/UVLO)} = 2\text{ V}$, $V_{(OVP)} = V_{(DMODE)} = V_{(PGTH)} = 0\text{ V}$, $R_{(ILIM)} = 150\text{ k}\Omega$, $C_{(OUT)} = 1\text{ }\mu\text{F}$, $C_{(dVdT)} = \text{OPEN}$, $\text{PGOOD} = \text{FLT} = \text{IMON} = \text{OPEN}$. (unless stated otherwise)

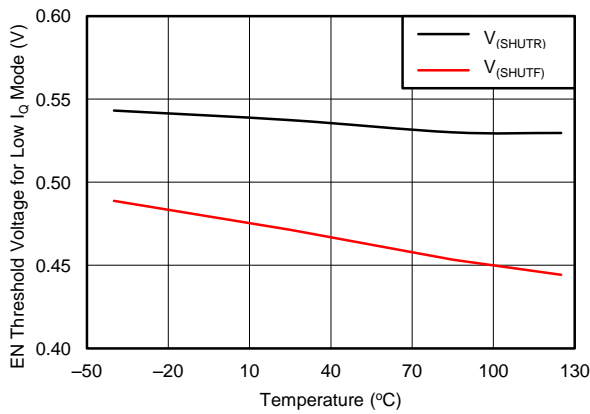

Figure 7. EN Threshold Voltage for Low IQ Mode vs Temperature

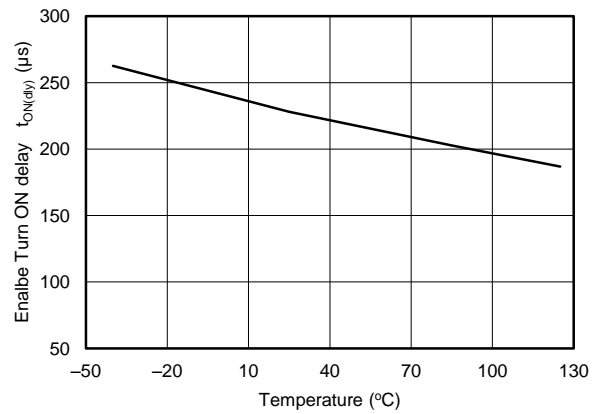

Figure 8. Enable Turnon Delay vs Temperature

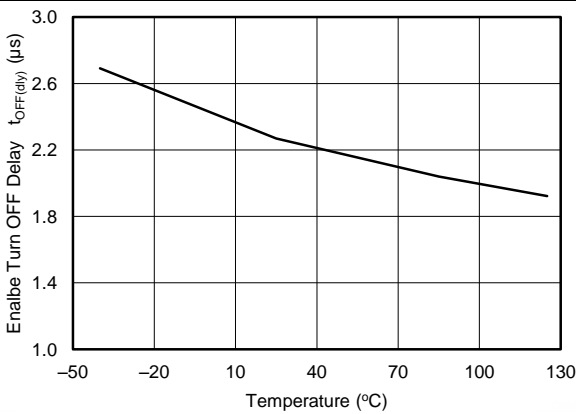

Figure 9. Enable Turnoff Delay vs Temperature

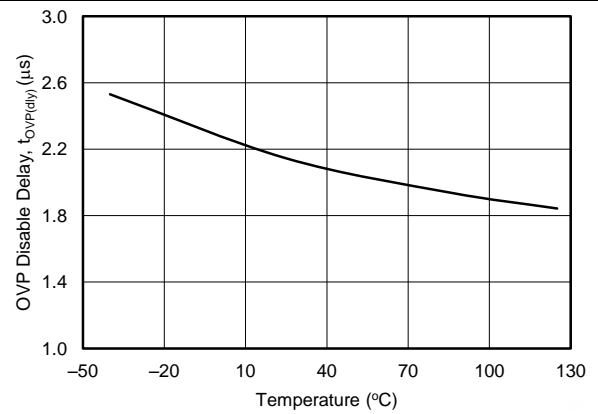

Figure 10. OVP Disable Delay vs Temperature

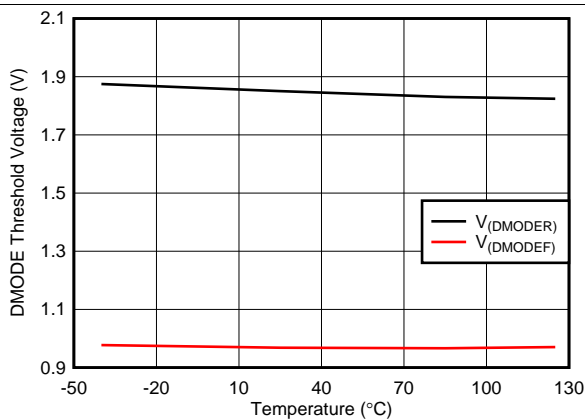

Figure 11. DMODE Threshold Voltage vs Temperature

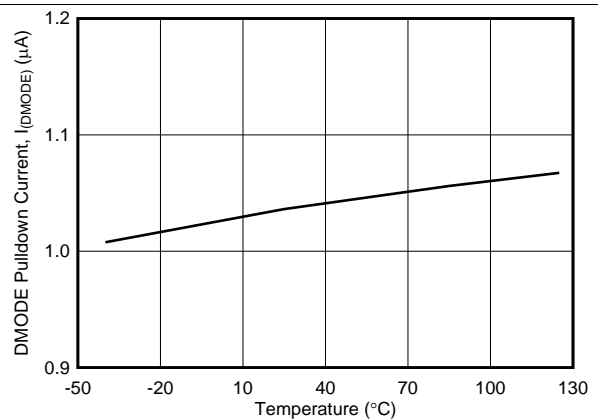

Figure 12. DMODE Pulldown Current vs Temperature

Typical Characteristics (continued)

Conditions are $-40^{\circ}\text{C} \leq T_J = T_A \leq +125^{\circ}\text{C}$, $V_{(IN)} = 12\text{ V}$, $V_{(ENUVLO)} = 2\text{ V}$, $V_{(OVP)} = V_{(DMODE)} = V_{(PGTH)} = 0\text{ V}$, $R_{(ILIM)} = 150\text{ k}\Omega$, $C_{(OUT)} = 1\text{ }\mu\text{F}$, $C_{(dVdT)} = \text{OPEN}$, $\text{PGOOD} = \text{FLT} = \text{IMON} = \text{OPEN}$. (unless stated otherwise)

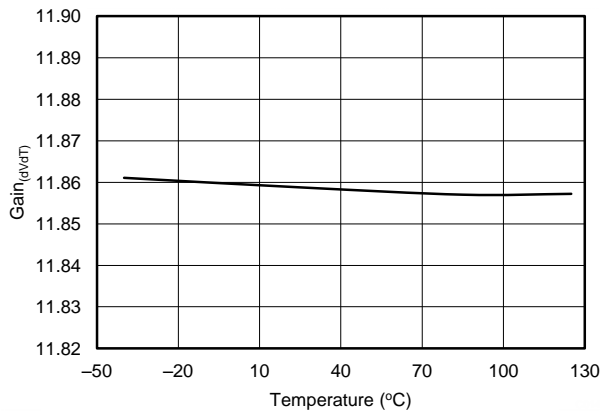

Figure 13. GAIN(dVdT) vs Temperature

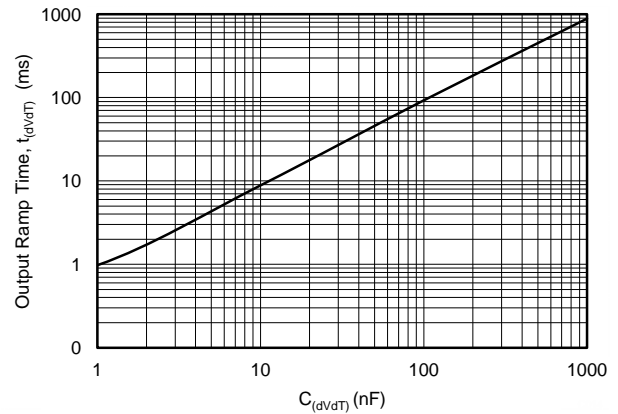

Figure 14. Output Ramp Time vs C(dVdT)

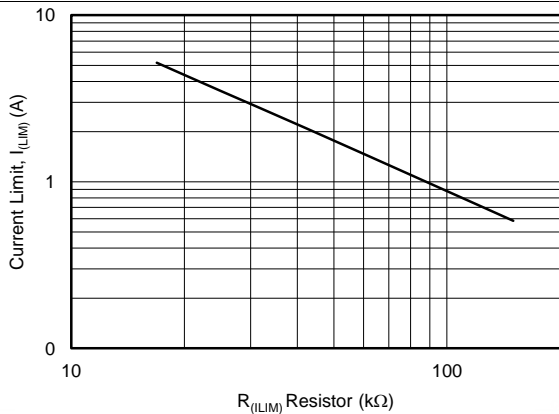

Figure 15. Current Limit vs Current Limit Resistor

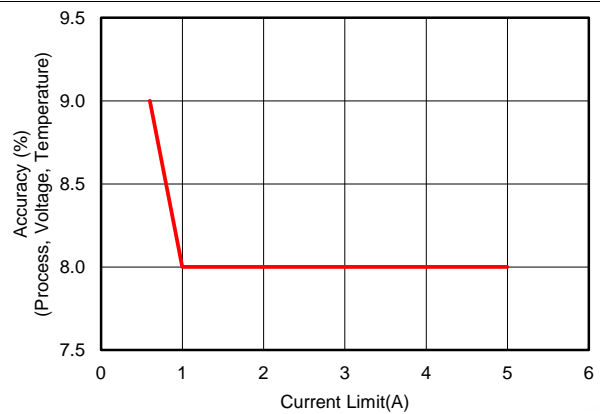

Figure 16. Current Limit Accuracy vs Current Limit

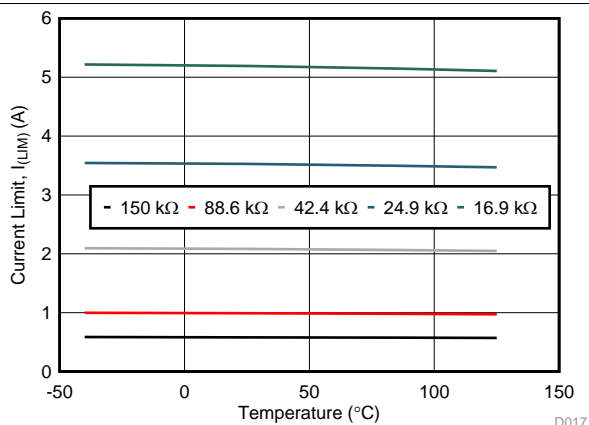

Figure 17. Current Limit vs Temperature Across R(ILIM)

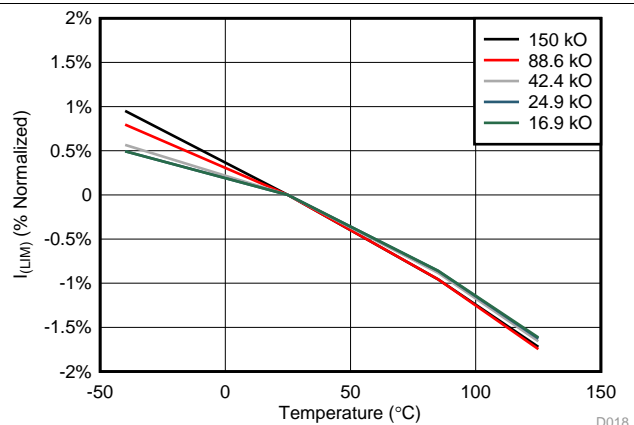
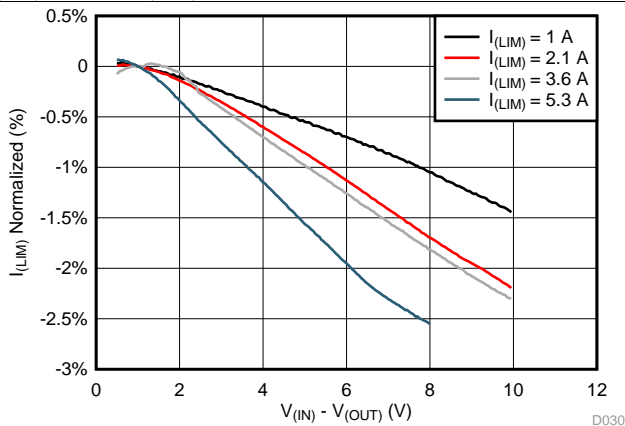

Figure 18. Current Limit (% Normalized) vs Temperature

Typical Characteristics (continued)

Conditions are $-40^{\circ}\text{C} \leq T_J = T_A \leq +125^{\circ}\text{C}$, $V_{(IN)} = 12\text{ V}$, $V_{(ENUVLO)} = 2\text{ V}$, $V_{(OVP)} = V_{(DMODE)} = V_{(PGTH)} = 0\text{ V}$, $R_{(ILIM)} = 150\text{ k}\Omega$, $C_{(OUT)} = 1\text{ }\mu\text{F}$, $C_{(dVdT)} = \text{OPEN}$, $\text{PGOOD} = \text{FLT} = \text{IMON} = \text{OPEN}$. (unless stated otherwise)



For $I_{(LIM)} = 5.3\text{ A}$, device goes into thermal shutdown for $[V_{(IN)} - V_{(OUT)}] > 8\text{ V}$

Figure 19. Current Limit Normalized (%) vs $V_{(IN)} - V_{(OUT)}$

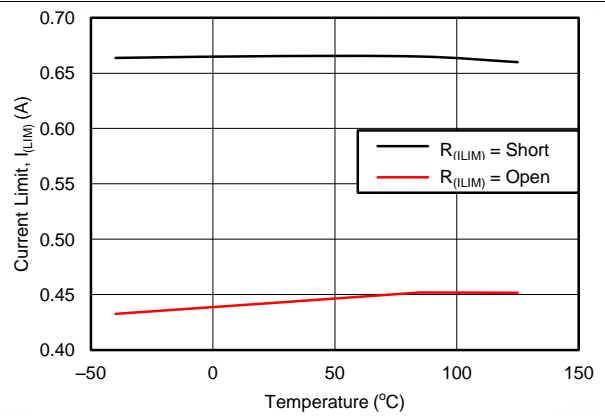

Figure 20. Current Limit for $R_{(ILIM)} = \text{Open}$ and Short vs Temperature

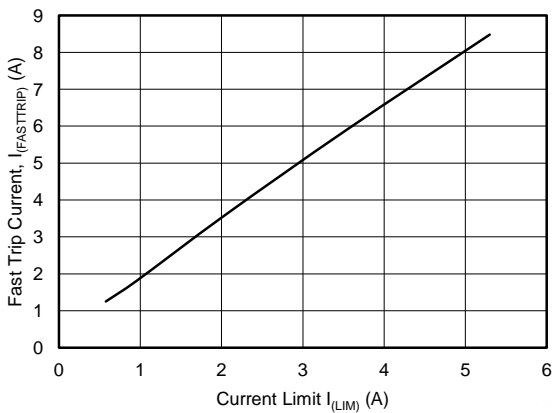

Figure 21. Fast Trip Threshold vs Current Limit

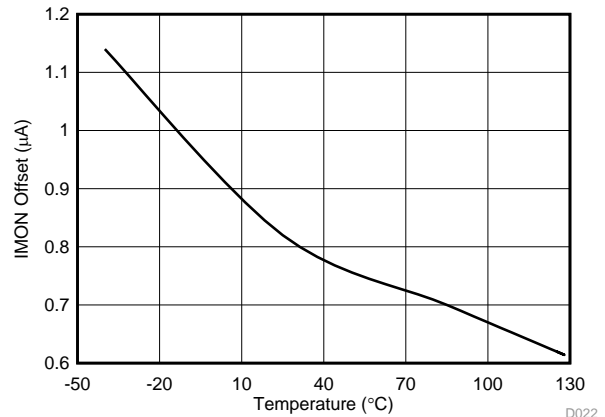

Figure 22. IMON Offset vs Temperature

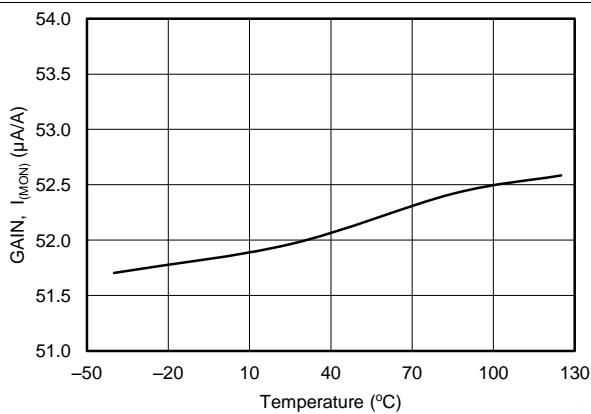

Figure 23. $\text{GAIN}_{(IMON)}$ vs Temperature

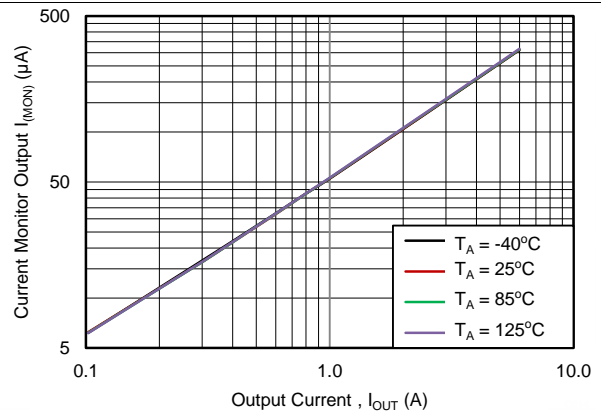

Figure 24. Current Monitor Output vs Output Current

Typical Characteristics (continued)

Conditions are $-40^{\circ}\text{C} \leq T_J = T_A \leq +125^{\circ}\text{C}$, $V_{(IN)} = 12\text{ V}$, $V_{(ENUVLO)} = 2\text{ V}$, $V_{(OVP)} = V_{(DMODE)} = V_{(PGTH)} = 0\text{ V}$, $R_{(ILIM)} = 150\text{ k}\Omega$, $C_{(OUT)} = 1\text{ }\mu\text{F}$, $C_{(dVdT)} = \text{OPEN}$, $\text{PGOOD} = \text{FLT} = \text{IMON} = \text{OPEN}$. (unless stated otherwise)

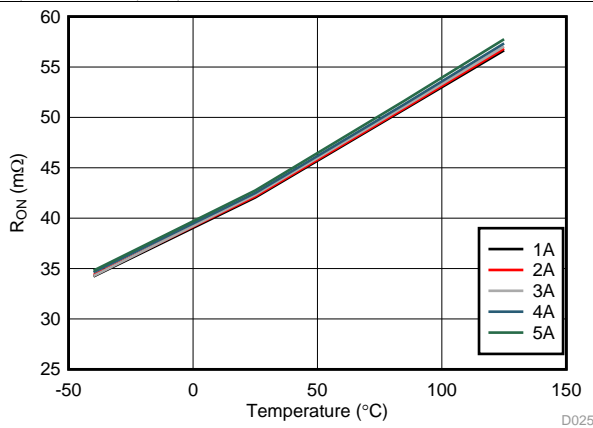

Figure 25. R_{ON} vs Temperature Across Load Current

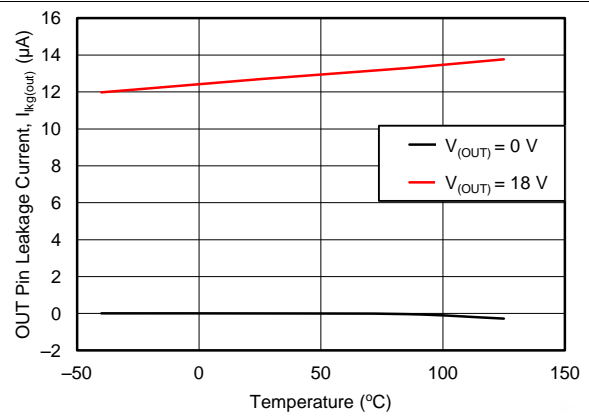

Figure 26. OUT Leakage Current in Off State vs Temperature

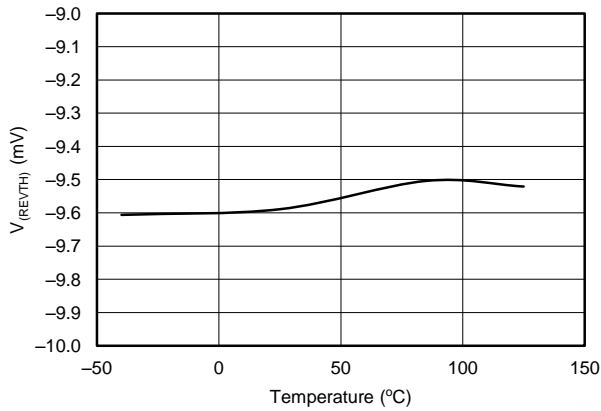

Figure 27. $V_{(REVTH)}$ vs Temperature

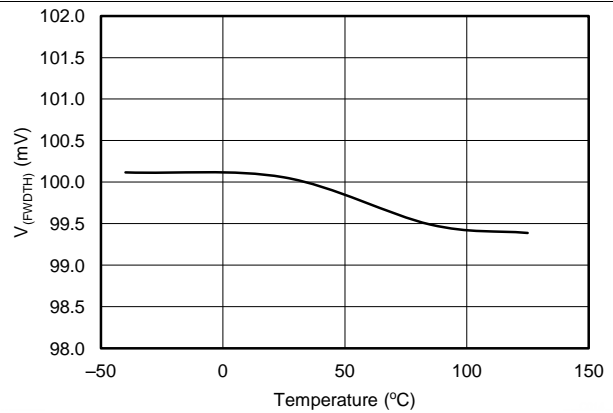

Figure 28. $V_{(FWDTH)}$ vs Temperature

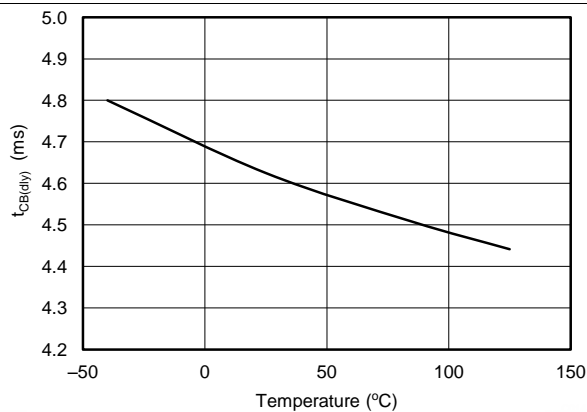
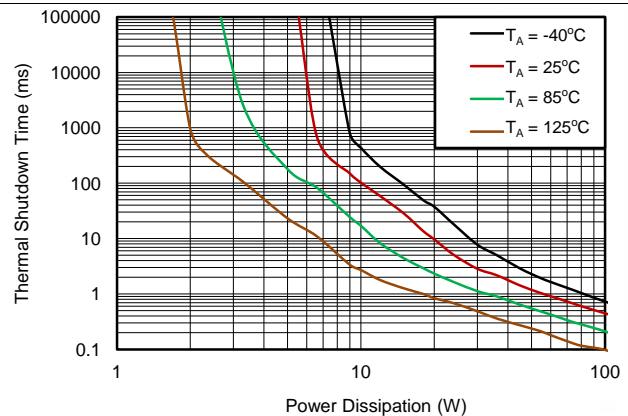

Figure 29. Circuit Breaker Timer Fault Assertion Delay vs Temperature



Taken on 2-Layer board, 2oz.(0.08-mm thick) with GND plane area: 14 cm² (Top) and 20 cm² (Bottom)

Figure 30. Thermal Shutdown Time vs Power Dissipation

Typical Characteristics (continued)

Conditions are $-40^{\circ}\text{C} \leq T_J = T_A \leq +125^{\circ}\text{C}$, $V_{(IN)} = 12\text{ V}$, $V_{(ENUVLO)} = 2\text{ V}$, $V_{(OVP)} = V_{(DMODE)} = V_{(PGTH)} = 0\text{ V}$, $R_{(ILIM)} = 150\text{ k}\Omega$, $C_{(OUT)} = 1\text{ }\mu\text{F}$, $C_{(dVdT)} = \text{OPEN}$, $\text{PGOOD} = \text{FLT} = \text{IMON} = \text{OPEN}$. (unless stated otherwise)

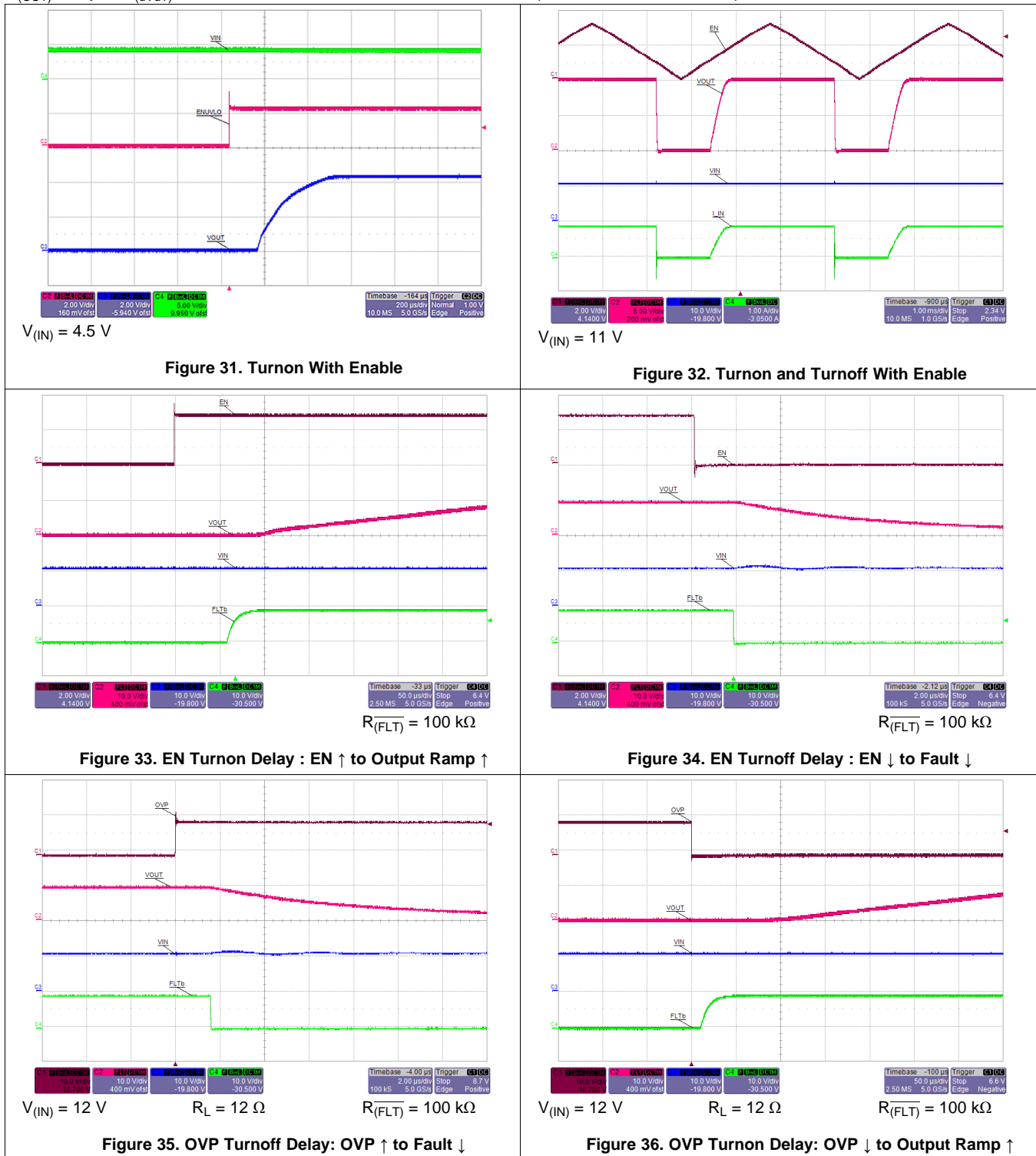

Typical Characteristics (continued)

Conditions are $-40^{\circ}\text{C} \leq T_J = T_A \leq +125^{\circ}\text{C}$, $V_{(IN)} = 12\text{ V}$, $V_{(ENUVLO)} = 2\text{ V}$, $V_{(OVP)} = V_{(DMODE)} = V_{(PGTH)} = 0\text{ V}$, $R_{(ILIM)} = 150\text{ k}\Omega$, $C_{(OUT)} = 1\text{ }\mu\text{F}$, $C_{(dVdT)} = \text{OPEN}$, $\text{PGOOD} = \text{FLT} = \text{IMON} = \text{OPEN}$. (unless stated otherwise)

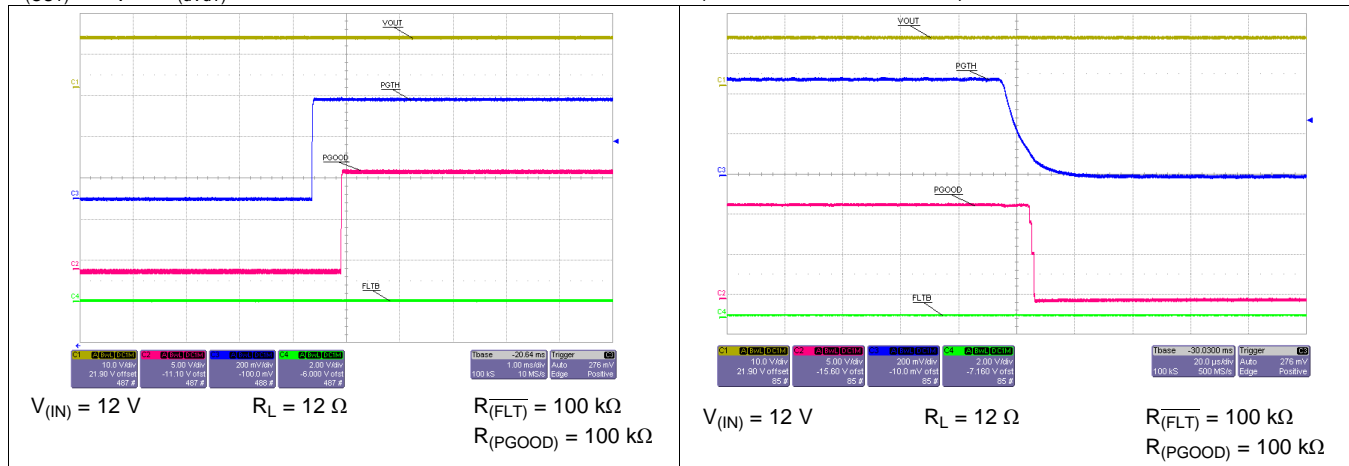

Figure 37. Power Good Delay (Rising)

Figure 38. Power Good Delay (Falling)

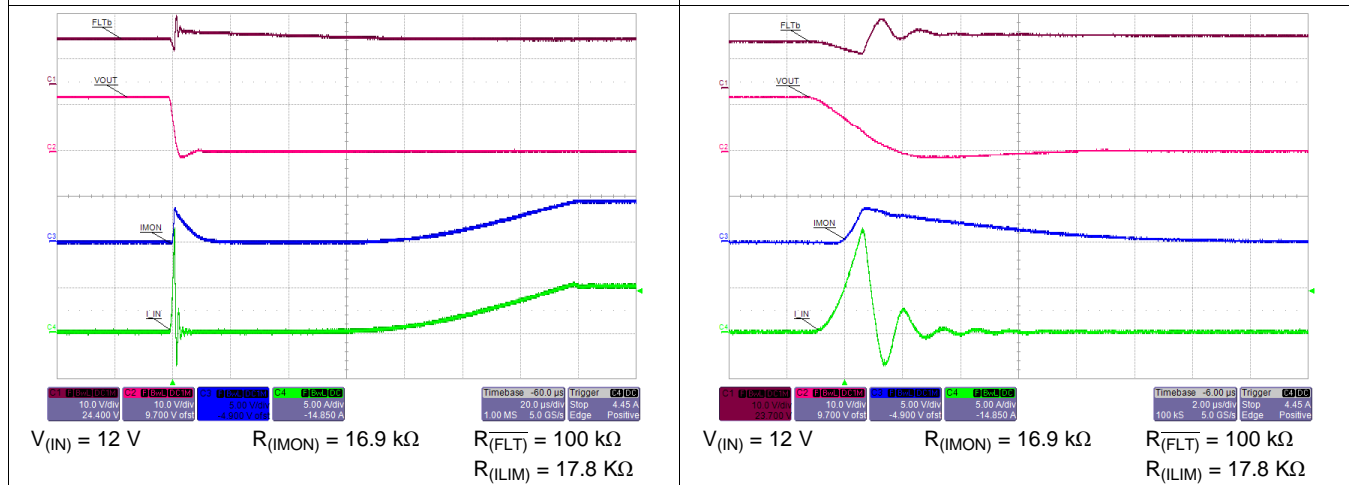

Figure 39. Hot-Short: Fast Trip Response and Current Regulation

Figure 40. Hot-Short: Fast Trip Response (Zoomed)

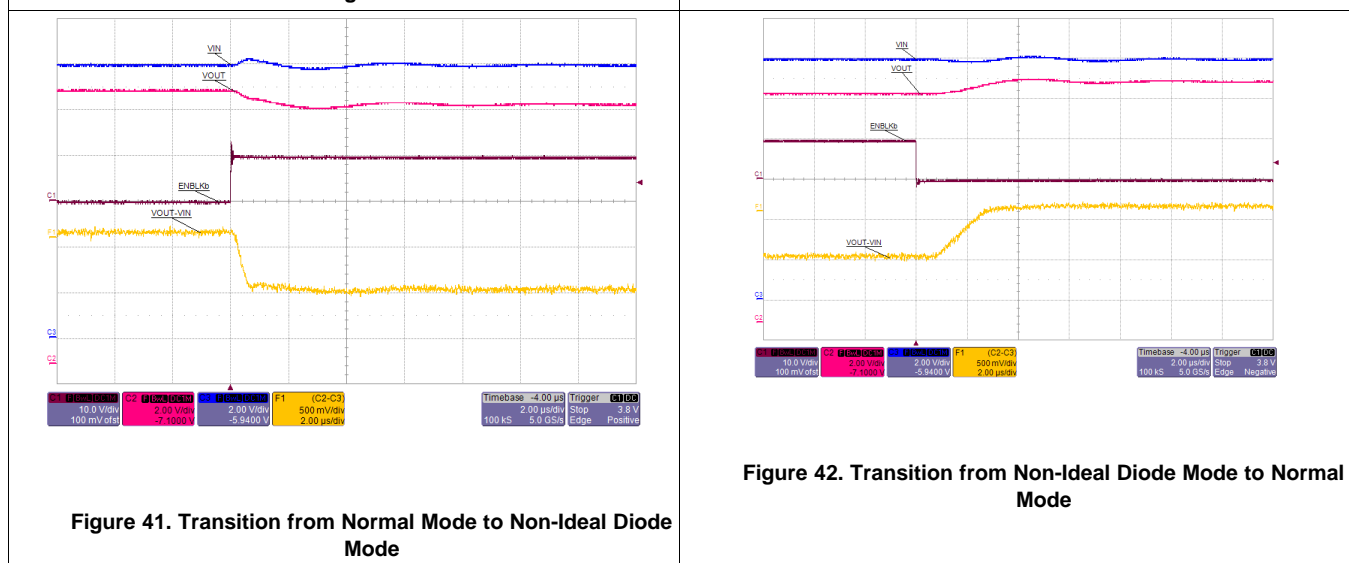

Figure 41. Transition from Normal Mode to Non-Ideal Diode Mode

Figure 42. Transition from Non-Ideal Diode Mode to Normal Mode

Typical Characteristics (continued)

Conditions are $-40^{\circ}\text{C} \leq T_J = T_A \leq +125^{\circ}\text{C}$, $V_{(IN)} = 12\text{ V}$, $V_{(ENUVLO)} = 2\text{ V}$, $V_{(OVP)} = V_{(DMODE)} = V_{(PGTH)} = 0\text{ V}$, $R_{(ILIM)} = 150\text{ k}\Omega$, $C_{(OUT)} = 1\text{ }\mu\text{F}$, $C_{(dVdT)} = \text{OPEN}$, $\text{PGOOD} = \text{FLT} = \text{IMON} = \text{OPEN}$. (unless stated otherwise)

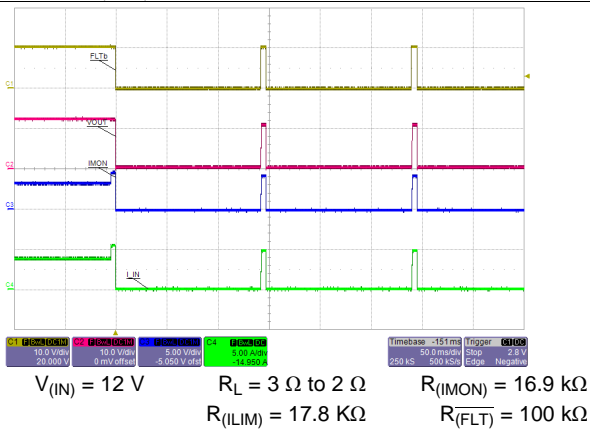

Figure 43. Overload: TPS25944A Circuit Break Function

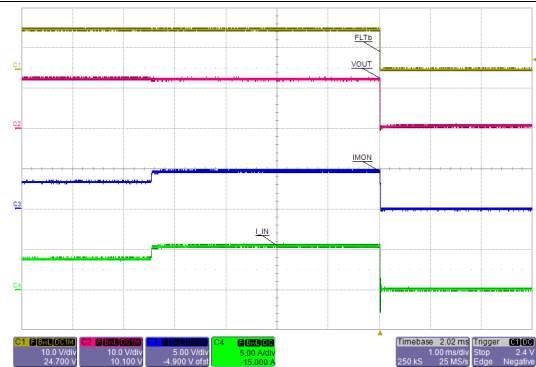

Figure 44. Overload: Zoomed In (First Cycle)

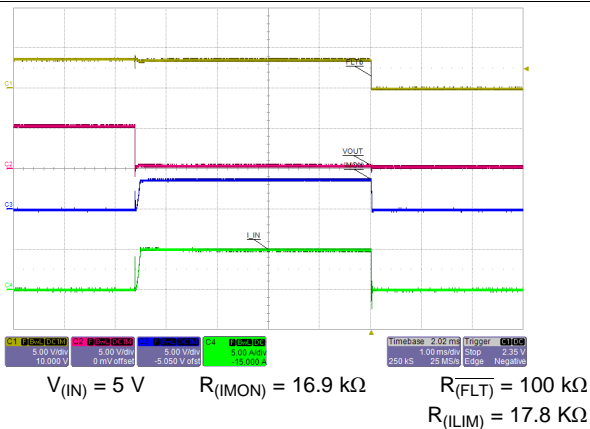

Figure 45. Hot Short Response: TPS25944A Device Turns Off after the Fault Timer $t_{CB(dly)}$ (4 ms) Expires

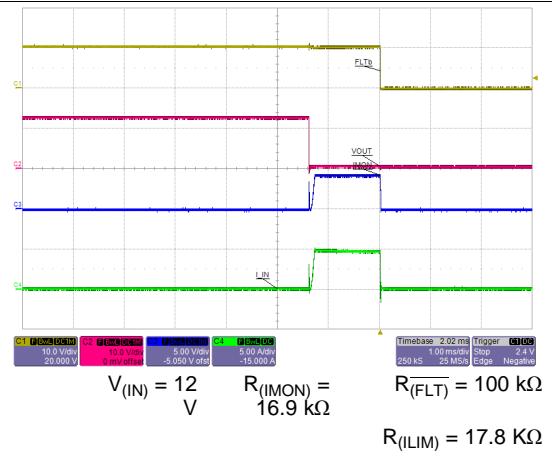

Figure 46. Hot Short Response: TPS25944A Device Turns Off When $T_J > T_{(TSD)}$ Before Timer Expires

8 Parameter Measurement Information

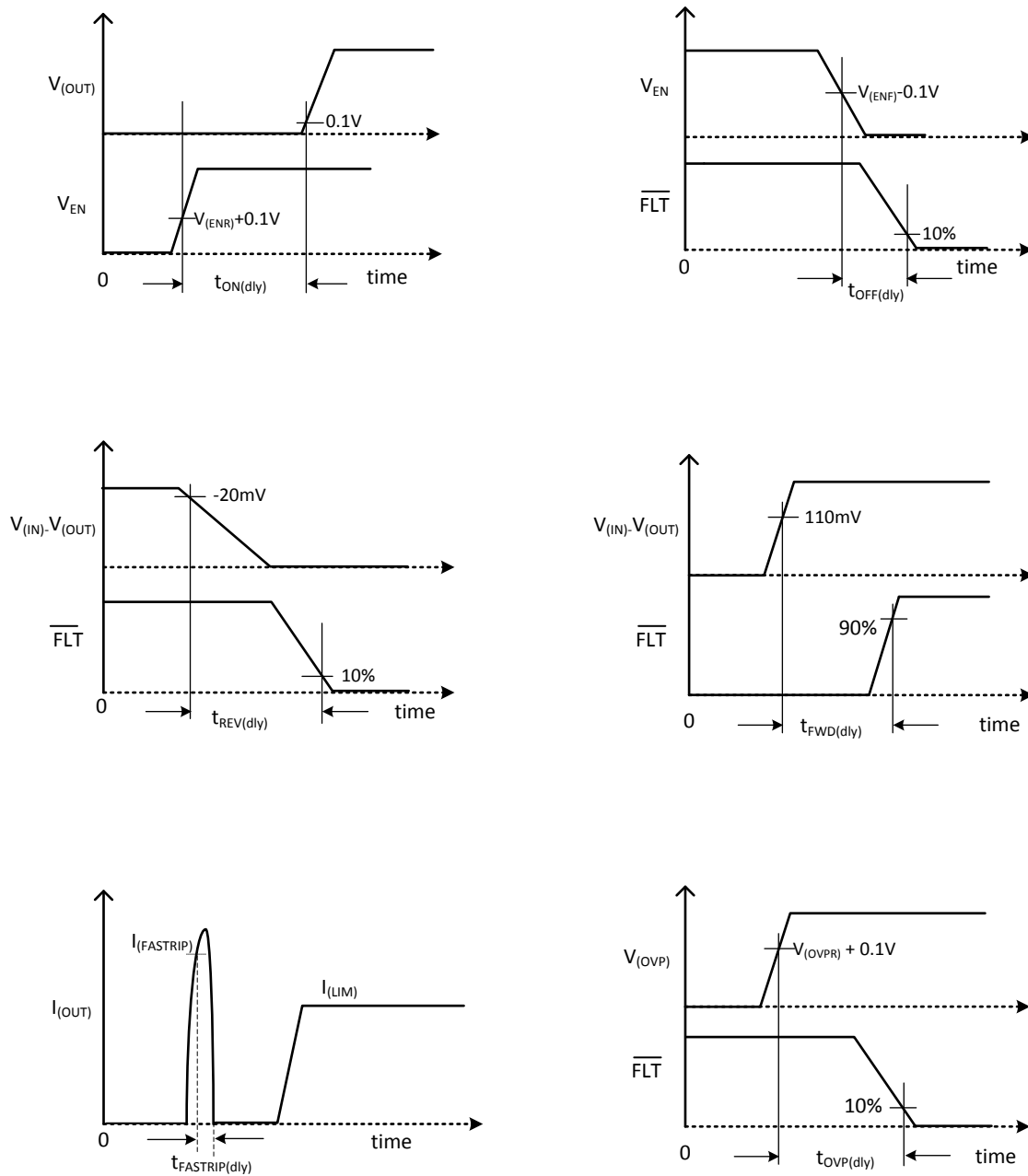

Figure 47. Timing Diagrams

9 Detailed Description

9.1 Overview

The TPS25942, TPS25944 is an eFuse Power Mux with integrated back-to-back FETs and enhanced built-in protection circuitry. It provides robust protection for all systems and applications powered from 2.7 V to 18 V.

For hot-plug-in boards, the device provides hot-swap power management with in-rush current control and programmable output ramp-rate. The device integrates overcurrent and short circuit protection. The precision overcurrent limit helps to minimize over design of the input power supply, while the fast response short circuit protection immediately isolates the load from input when a short circuit is detected. The device allows the user to program the overcurrent limit threshold between 0.6 A and 5.3 A via an external resistor.

The device provides precise monitoring of voltage bus for brown-out and overvoltage conditions and asserts fault for downstream system. Its overall threshold accuracy of 2% ensures tight supervision of bus, eliminating the need for a separate supply voltage supervisor chip. The TPS25942, TPS25944 is designed to control redundant power supply systems. The devices monitor $V_{(IN)}$ and $V_{(OUT)}$ to provide true reverse blocking from output when reverse condition or input power fail condition is detected. Also, a pair of the TPS25942 or TPS25944 devices can be configured to assign priority to the main power supply over the auxiliary power supply.

The additional features include:

- Precise current monitor output for health monitoring of the system
- Additional power good comparator with precision internal reference for output or any other rail voltage monitoring
- Electronic circuit breaker operation with overload timeout – TPS25944 only
- Over temperature protection to safely shutdown in the event of an overcurrent event
- De-glitched fault reporting for brown-out and overvoltage faults
- A choice of latched or automatic restart mode

9.2 Functional Block Diagram

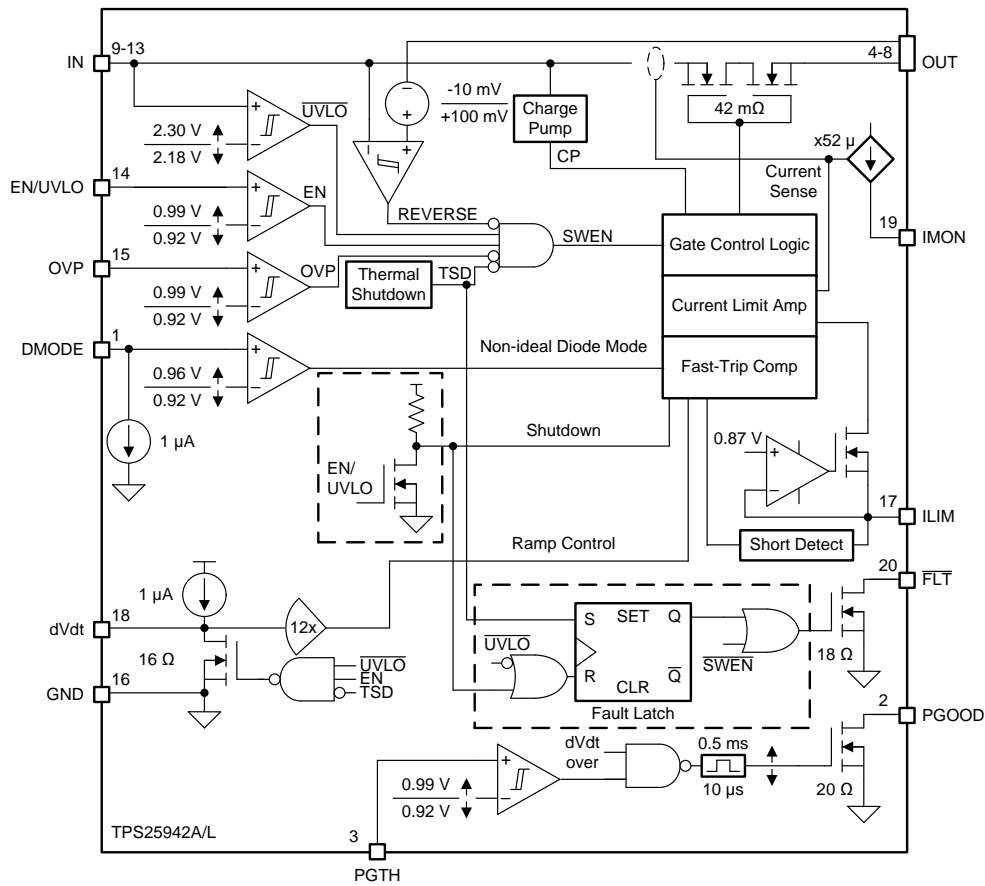

Copyright © 2017, Texas Instruments Incorporated

Figure 48. TPS25942A/L Block Diagram

Functional Block Diagram (continued)

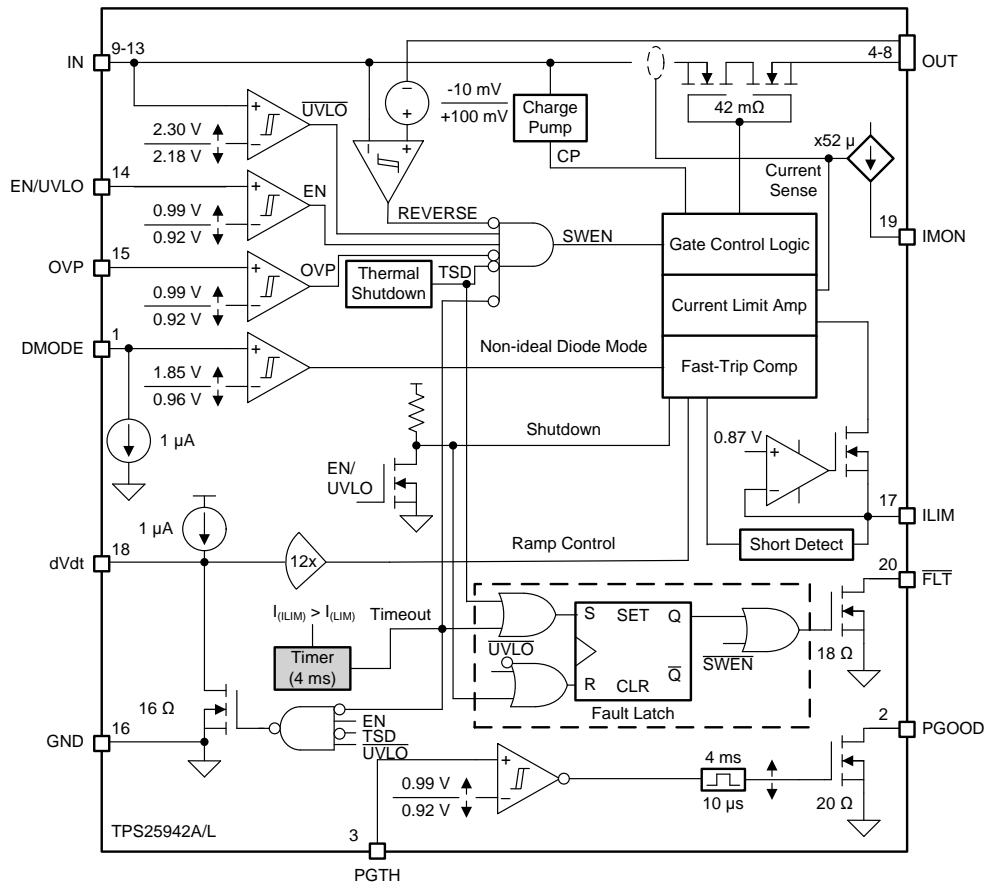

Copyright © 2017, Texas Instruments Incorporated

Figure 49. TPS25944A/L Block Diagram

9.3 Feature Description

9.3.1 Enable and Adjusting Undervoltage Lockout

The EN/UVLO pin controls the ON and OFF state of the internal FET. A voltage $V_{(EN/UVLO)} < V_{(ENF)}$ on this pin turns off the internal FET, thus disconnecting IN from OUT, while voltage below 0.6 V takes the device into shutdown mode, with I_Q less than 20 μ A to ensure minimal power loss. Cycling EN/UVLO low and then back high resets the TPS2594xL that has latched off due to a fault condition.

The internal de-glitch delay on EN/UVLO falling edge is kept low for quick detection of power failure. For applications where a higher de-glitch delay on EN/UVLO is desired, or when the supply is particularly noisy, it is recommended to use an external bypass capacitor from EN/UVLO terminal to GND.

The undervoltage lock out can be programmed by using an external resistor divider from supply IN terminal to EN/UVLO terminal to GND as shown in [Figure 50](#). When an undervoltage or input power fail event is detected, the internal FET is quickly turned off, and \overline{FLT} is asserted. If the Under-Voltage Lock-Out function is not needed, the EN/UVLO terminal must be connected to the IN terminal. EN/UVLO terminal must not be left floating.

The device also implements internal undervoltage-lockout (UVLO) circuitry on the IN terminal. The device disables when the IN terminal voltage falls below internal UVLO Threshold $V_{(UVF)}$. The internal UVLO threshold has a hysteresis of 115 mV.

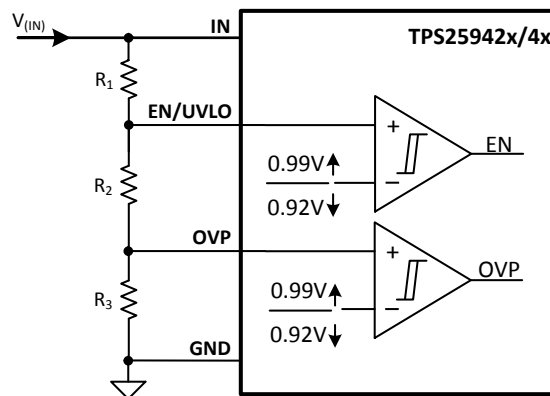

Figure 50. UVLO and OVP Thresholds Set By R_1 , R_2 and R_3

9.3.2 Overvoltage Protection (OVP)

The device incorporates circuit to protect system during overvoltage conditions. A resistor divider connected from the supply to OVP terminal to GND (as shown in [Figure 50](#)) programs the overvoltage threshold. A voltage more than $V_{(OVPR)}$ on OVP pin turns off the internal FET and protects the downstream load. This pin must be tied to GND when not used.

9.3.3 Hot Plug-In and In-Rush Current Control

The device is designed to control the in-rush current upon insertion of a card into a live backplane or other "hot" power source. This limits the voltage sag on the backplane's supply voltage and prevents unintended resets of the system power. A slew rate controlled start-up (dVdT) also helps to eliminate conductive and radiative interferences. An external capacitor connected from the dVdT pin to GND defines the slew rate of the output voltage at power-on (as shown in [Figure 51](#)). Equation governing slew rate at start-up is shown in [Equation 1](#).

Feature Description (continued)

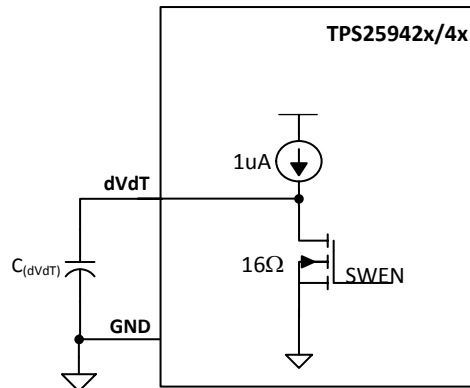

Figure 51. Output Ramp Up Time t_{dVdT} is Set by C_{dVdT}

$$I_{dVdT} = \left(\frac{C_{dVdT}}{\text{GAIN}_{dVdT}} \right) \times \left(\frac{dV_{(OUT)}}{dt} \right)$$

where

- $I_{dVdT} = 1 \mu\text{A}$ (typical)
- $\frac{dV_{(OUT)}}{dt}$ = Desired output slew rate
- $\text{GAIN}_{dVdT} = dVdT$ to OUT gain = 12

The total ramp time (t_{dVdT}) of $V_{(OUT)}$ for 0 to $V_{(IN)}$ can be calculated using [Equation 2](#).

$$t_{dVdT} = 8.3 \times 10^4 \times V_{(IN)} \times C_{dVdT}$$

The inrush current, $I_{(INRUSH)}$ can be calculated as shown in [Equation 3](#).

$$I_{(INRUSH)} = C_{(OUT)} \times V_{(IN)} / t_{dVdT}$$

The dVdT pin can be left floating to obtain a predetermined slew rate (t_{dVdT}) on the output. When terminal is left floating, the device sets an internal ramp rate of 30 V/ms for output ($V_{(OUT)}$) ramp.

[Figure 61](#) and [Figure 62](#) illustrate the inrush current control behavior of the TPS25942, TPS25944. For systems where load is present during start-up, the current never exceeds the overcurrent limit set by $R_{(ILIM)}$ resistor for the application. For defining appropriate charging time/rate under different load conditions, see the [Setting Output Voltage Ramp Time \(\$t_{dVdT}\$ \)](#) section.

9.3.4 Overload and Short Circuit Protection

The device monitors load current by sensing the voltage across the internal sense resistor. The FET current is monitored at both the start-up and during normal operation. During overload events, the device keeps the over current limited to the overcurrent limit ($I_{(LIM)}$) programmed by $R_{(ILIM)}$ resistor as shown in [Equation 4](#).

$$I_{(LIM)} = \frac{89}{R_{(ILIM)}}$$

where

- $I_{(LIM)}$ is overload current limit in Ampere.
- $R_{(ILIM)}$ is the current limit resistor in $k\Omega$

The device incorporates two distinct levels: an overcurrent-limit ($I_{(LIM)}$) and a fast-trip threshold ($I_{(FASTTRIP)}$). The illustration of fast trip and current limit operation is shown in [Figure 52](#).

Since the bias current on ILIM pin directly controls the current-limiting behavior of the device, the PCB routing of this node must be kept away from any noisy (switching) signals.

Feature Description (continued)

9.3.4.1 Overload Protection

During overload conditions, the internal current-limit amplifier in the TPS25942 regulates the output current to $I_{(LIM)}$. The output voltage droops during current regulation, resulting in increased device power dissipation. If the device junction temperature reaches the thermal shutdown threshold ($T_{(TSD)}$), the internal FET is turned off. Once in thermal shutdown, the TPS25942L and 44L version stays latched off, whereas the TPS25942A and 44A commences an auto-retry cycle 128 ms after $T_J < [T_{(TSD)} - 12^\circ\text{C}]$. During thermal shutdown, the fault pin \overline{FLT} pulls low to signal a fault condition. Figure 65 and Figure 66 illustrate the behavior of the system for overload conditions in the TPS25942.

The TPS25944 allows the overload current to flow through the device until $I_{(LOAD)} < I_{(FASTRIP)}$. It starts the timer when $I_{(LIM)} < I_{(LOAD)} < I_{(FASTRIP)}$, and once the timer exceeds $t_{CB(dly)}$, the internal FET is turned off and \overline{FLT} is asserted.

9.3.4.2 Short Circuit Protection

During a transient short circuit event, the current through the device increases very rapidly. As current-limit amplifier cannot respond quickly to this event due to its limited bandwidth, the device incorporates a fast-trip comparator, with a threshold $I_{(FASTRIP)}$. This comparator shuts down the pass device within 1 μs , when the current through internal FET exceeds $I_{(FASTRIP)}$ ($I_{(OUT)} > I_{(FASTRIP)}$), and terminates the rapid short-circuit peak current. The trip threshold is set to more than 50% of the programmed overload current limit ($I_{(FASTRIP)} = 1.5 \times I_{(LIM)} + 0.375$). The fast-trip circuit holds the internal FET off for only a few microseconds, after which the device turns back on slowly, allowing the current-limit loop to regulate the output current to $I_{(LIM)}$. Then, device behaves similar to overload condition. Figure 67 through Figure 69 illustrate the behavior of the system when the current exceeds the fast-trip threshold.

9.3.4.3 Start-Up With Short on Output

During start-up with short, the device limits the current to $I_{(LIM)}$ and behaves similar to the overload condition afterwards. Figure 70 and Figure 71 illustrate the behavior of the device for start-up with short on the output. This feature helps in quick isolation of the fault and hence ensures stability of the DC bus.

9.3.4.4 Constant Current Limit Behavior During Overcurrent Faults

If during current limit, power dissipation of the internal FET $P_D = (V_{(IN)} - V_{(OUT)}) \times I_{(OUT)}$ exceeds 10 W, there is an approximately 0% to 5% thermal fold back in the current limit value so that $I_{(LIM)}$ drops to I_{OS} . Eventually, the device shuts down due to over temperature.

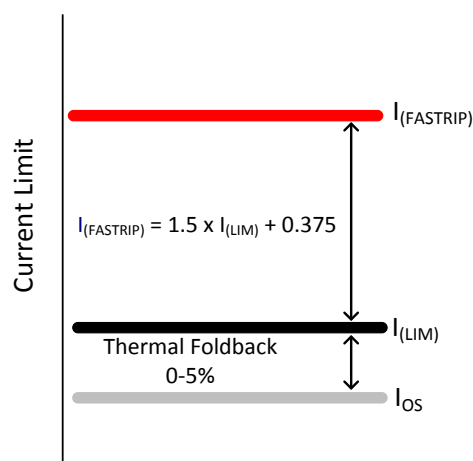

Figure 52. Fast-Trip Current

Feature Description (continued)

9.3.5 Reverse Current Protection

A fast reverse comparator controls the internal FET and turns off the FET whenever the output voltage $V_{(OUT)}$ exceeds the input voltage $V_{(IN)}$ by 10 mV (typical) for 1 μ s (typical). This prevents damage to the devices on the input side of the TPS2594xx by preventing significant current from sinking into the input side. However, a reverse current of $(V_{(OUT)} - V_{(IN)}) / R_{ON}$ should flow from the output to the input to establish reverse voltage $V_{(REVTH)}$ of –10 mV across the device. The typical value of reverse current, needed for reverse voltage detection is $-10 \text{ mV} / 42 \text{ m}\Omega = -238 \text{ mA}$

In power muxing applications, the reverse current magnitude $I_{(REV)}$ depends on the slew-rate of the output voltage $V_{(OUT)}$ and the system input capacitance C_{IN} as shown in Equation 5.

$$I_{(REV)} = C_{IN} \times \left(\frac{dV_{(OUT)}}{dt} \right) \quad (5)$$

For example, if the ramp rate of the output voltage is set at 10 mV/ μ s then the required input capacitance C_{IN} to achieve reverse current greater than 238 mA is 23.8 μ F. Considering tolerance of $\pm 10\%$ in capacitance and a standard value, capacitor of 33 μ F should be used as C_{IN} in this case.

9.3.6 FAULT Response

The $\overline{\text{FLT}}$ open-drain output is asserted (active low) during undervoltage, overvoltage, reverse voltage-current and thermal shutdown conditions. Additionally, in the TPS25944, the $\overline{\text{FLT}}$ is asserted when overload condition exists for more than the fault time period ($t_{CB(dly)}$). The $\overline{\text{FLT}}$ signal remains asserted until the fault condition is removed and the device resumes normal operation. The device is designed to eliminate false fault reporting by using an internal "de-glitch" circuit for undervoltage and overvoltage (2.2- μ s typical) conditions without the need for external circuitry. This ensures that fault is not accidentally asserted during transients on input bus.

Connect $\overline{\text{FLT}}$ with a pull up resistor to Input or Output voltage rail. $\overline{\text{FLT}}$ may be left open or tied to ground when not used. $V_{(IN)}$ falling below $V_{(UVF)} = 2.1 \text{ V}$ resets $\overline{\text{FLT}}$.

9.3.7 Current Monitoring

The current source at IMON terminal is configured to be proportional to the current flowing from IN to OUT. This current can be converted to a voltage using a resistor $R_{(IMON)}$ from IMON terminal to GND terminal. This voltage, computed using Equation 7, can be used as a means of monitoring current flow through the system.

The maximum voltage range for monitoring the current ($V_{(IMONmax)}$) is limited to minimum($[V_{(IN)} - 2.2 \text{ V}]$, 6 V) to ensure linear output. This puts limitation on maximum value of $R_{(IMON)}$ resistor and is determined by Equation 6.

$$R_{(IMONmax)} = \frac{\text{minimum}(V_{(IN)} - 2.2, 6)}{1.6 \times I_{(LIM)} \times \text{GAIN}_{(IMON)}} \quad (6)$$

The output voltage at IMON terminal is calculated from Equation 7.

$$V_{(IMON)} = [I_{(OUT)} \times \text{GAIN}_{(IMON)} + I_{(IMON_OS)}] \times R_{(IMON)}$$

where

- $\text{GAIN}_{(IMON)}$ = Gain factor $I_{(IMON)}:I_{(OUT)} = 52 \mu\text{A}/\text{A}$
 - $I_{(OUT)}$ = Load current
 - $I_{(IMON_OS)} = 0.8 \mu\text{A}$ (typical)
- (7)

This pin must not have a bypass capacitor to avoid delay in the current monitoring information.

The voltage at IMON pin can be digitized using an ADC (such as ADS1100, [SBAS239](#)) to read the current monitor information over an I2C bus.

Feature Description (continued)

9.3.8 Power Good Comparator

The devices incorporate a Power Good comparator for co-ordination of status to downstream DC-DC converters or system monitoring circuits. The comparator has an internal reference of $V_{(PGTHR)} = 0.99\text{ V}$ at negative terminal and positive terminal PGTH can be utilized for monitoring of either input or output of the device. The comparator output PGOOD is an open-drain active high signal, which can be used to indicate the status to downstream units. PGOOD is asserted high when internal FET is fully enhanced and PGTH pin voltage is higher than internal reference $V_{(PGTHR)}$.

The PGOOD signal has deglitch time incorporated to ensure that internal FET is fully enhanced before heavy load is applied by downstream converters. Rising deglitch delay is determined by [Equation 8](#).

$$t_{\text{PGOOD(DEGL)}} = \text{Maximum} \{ (3.5 \times 10^6 \times C_{(dVdT)}), t_{\text{PGOODR}} \} \quad (8)$$

Connect the PGOOD pin with a pull up resistor to Input or Output voltage rail. PGOOD may be left open or tied to ground when not used.

9.3.9 IN, OUT and GND Pins

The device has multiple pins for input (IN) and output (OUT).

All IN pins must be connected together and to the power source. A ceramic bypass capacitor close to the device from IN to GND is recommended to alleviate bus transients. The recommended operating voltage range is 2.7 V-18 V.

Similarly all OUT pins must be connected together and to the load. $V_{(OUT)}$ in the ON condition, is calculated using [Equation 9](#).

$$V_{(OUT)} = V_{(IN)} - (R_{ON} \times I_{(OUT)}) \quad (9)$$

where, R_{ON} is the total ON resistance of the internal FET.

GND terminal is the most negative voltage in the circuit and is used as a reference for all voltage reference unless otherwise specified.

9.3.10 Thermal Shutdown

The device has built-in over temperature shutdown circuitry designed to disable the internal FET, if the junction temperature exceeds 160°C (typical). The TPS25942L, 44L version latches off the internal FET, whereas the TPS25942A, 44A commences an auto-retry cycle 128 ms after $T_J < [T_{(TSD)} - 12^\circ\text{C}]$. During the thermal shutdown, the fault pin FLT pulls low to signal a fault condition.

9.4 Device Functional Modes

9.4.1 Diode Mode

The device provides a Diode Mode, where the power path from IN to OUT acts as a non-ideal diode rather than a FET, as shown in [Figure 53](#). This mode is activated through DMODE terminal. This is an active high terminal with internal pull-down. The terminal is useful in Power-Mux applications to switch over from master to slave supplies and vice-versa smoothly, when two supplies are within a diode drop of each other. A high at this terminal activates the non-ideal diode mode. In this mode, the circuit breaker functionality (TPS25944x) is disabled and the overload current limit is set to 50 % of current limit determined by $R_{(ILIM)}$ resistor.

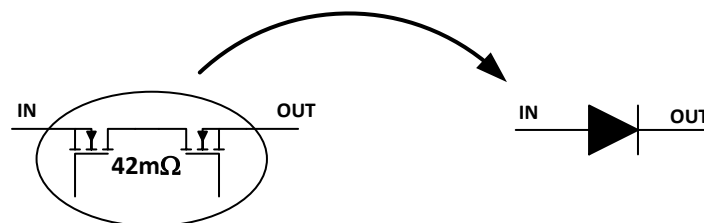

Figure 53. Diode Mode: IN to OUT Power Path

Device Functional Modes (continued)

9.4.2 Shutdown Control

The internal FET and hence the load current can be remotely switched off by taking the UVLO pin below its 0.6 V threshold with an open collector or open drain device as shown in Figure 54. The device quiescent current is reduced to less than 20 μA in this state. Upon releasing the UVLO pin the device turns on with soft-start cycle.

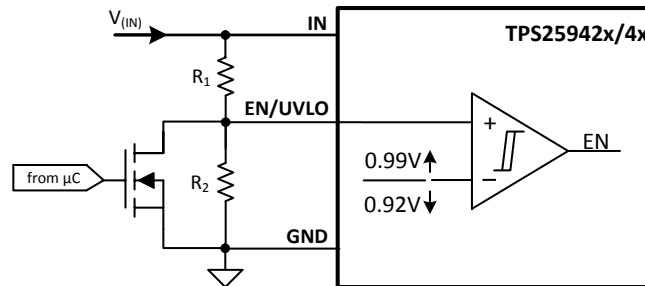

Figure 54. Shutdown Control

Device Functional Modes (continued)

9.4.3 Operational Differences Between the TPS25942 and TPS25944

The TPS25942 and TPS25944 respond differently to overload and short circuit conditions. The operational differences are explained in [Table 1](#).

Table 1. Device Operational Differences

Device	TPS25942 (Current Limiter)	TPS25944 (Circuit Breaker)
Start-up	Inrush ramp controlled by dVdT	Inrush ramp controlled by dVdT
	Inrush limited to $I_{(LIM)}$ level as set by $R_{(ILIM)}$	Inrush limited to $I_{(LIM)}$ level as set by $R_{(ILIM)}$
		Fault Timer runs when current is limited to $I_{(LIM)}$
		Fault timer expires after $t_{CB(dly)}$ (4 ms) causing device shutoff
	If $T_J > T_{(TSD)}$ device shuts off	Device turns off if $T_J > T_{(TSD)}$ before timer expires
Over current response	Current is limited to $I_{(LIM)}$ level as set by $R_{(ILIM)}$	Current is allowed through the device if $I_{(LOAD)} < I_{(FASTRIP)}$
	Power dissipation increases as $V_{(IN)} - V_{(OUT)}$ grows	Fault Timer runs when current goes above $I_{(LIM)}$
		Fault timer expires after $t_{CB(dly)}$ (4 ms) causing device shutoff
	Device turns off when $T_J > T_{(TSD)}$	Device turns off if $T_J > T_{(TSD)}$ before timer expires
	'L' Version remains off	'L' Version remains off
	'A' Version attempts restart 128 ms after $T_J < [T_{(TSD)} - 12^\circ\text{C}]$	'A' Version attempts restart 128 ms after $T_J < [T_{(TSD)} - 12^\circ\text{C}]$
Short-circuit response	Fast shut off when $I_{(LOAD)} > I_{(FASTRIP)}$	Fast shut off when $I_{(LOAD)} > I_{(FASTRIP)}$
	Quick restart and current limited to $I_{(LIM)}$, follows standard TPS25942 start-up	Quick restart and current limited to $I_{(LIM)}$, follows standard TPS25944 start-up

10 Application and Implementation

NOTE

Information in the following applications sections is not part of the TI component specification, and TI does not warrant its accuracy or completeness. TI's customers are responsible for determining suitability of components for their purposes. Customers should validate and test their design implementation to confirm system functionality.

10.1 Application Information

The device is a smart eFuse. It is typically used for Active ORing and Power Multiplexing applications. It operates from 2.7 V to 18 V with programmable current limit, overvoltage and undervoltage protection. The device aids in controlling the in-rush current and in seamless power path management of multiple voltage rails for systems such as PCIe cards, Network and Graphic Cards and SSDs. The device also provides robust protection for multiple faults on the sub-system rail.

The following design procedure can be used to select component values for the TPS25942, TPS25944.

Alternatively, the WEBENCH® software may be used to generate a complete design. The WEBENCH® software uses an iterative design procedure and accesses a comprehensive database of components when generating a design. Additionally, a spreadsheet design tool [TPS25942_44 Design Calculator](#) is available on web folder.

This section presents a simplified discussion of the design process.

10.2 Typical Application

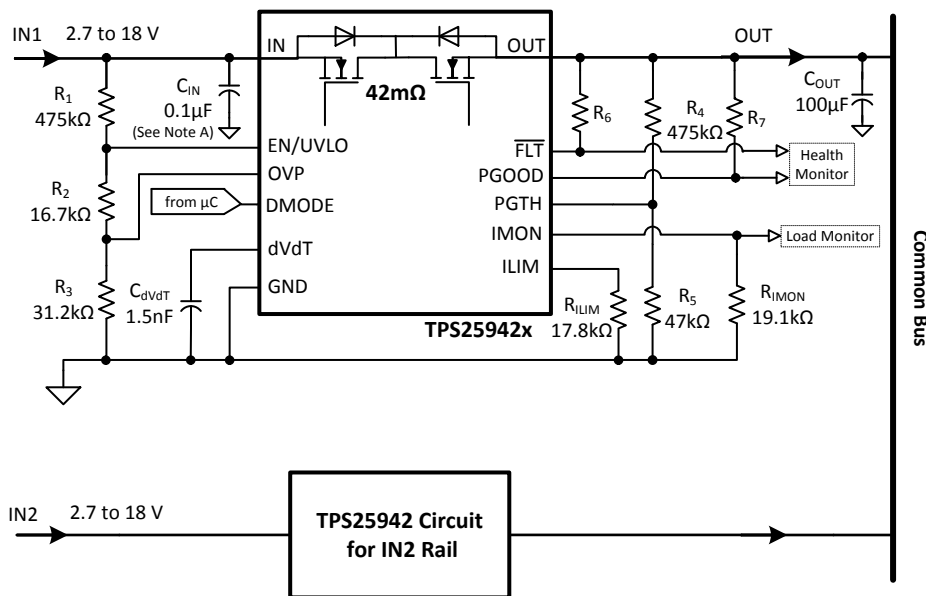

A. C_{IN} : Optional and only for noise suppression.

Figure 55. Typical Application Schematics: Active ORing Configuration

Typical Application (continued)

10.2.1 Design Requirements

Table 2 lists the TPS25942, TPS25944 design parameters.

Table 2. Design Parameters

DESIGN PARAMETER	EXAMPLE VALUE
Input voltage, $V_{(IN)}$	12 V
Undervoltage lockout set point, $V_{(UV)}$	10.8 V
Overvoltage protection set point, $V_{(OV)}$	16.5 V
Load at start-up, $R_{L(SU)}$	4.8 Ω
Current limit, $I_{(LIM)}$	5 A
Load capacitance, $C_{(OUT)}$	100 μ F
Maximum ambient temperatures, T_A	85°C

10.2.2 Detailed Design Procedure

The following design procedure can be used to select component values for the TPS25942, TPS25944.

10.2.2.1 Step by Step Design Procedure

To begin the design process a few parameters must be decided upon. The designer needs to know the following:

- Normal input operation voltage
- Maximum output capacitance
- Maximum current Limit
- Load during start-up
- Maximum ambient temperature of operation

This design procedure below seeks to control the junction temperature of device under both static and transient conditions by proper selection of output ramp-up time and associated support components. The designer can adjust this procedure to fit the application and design criteria.

10.2.2.2 Programming the Current-Limit Threshold: $R_{(ILIM)}$ Selection

$R_{(ILIM)}$ sets the current limit. Using Equation 4.

$$R_{(ILIM)} = \frac{89}{5} = 17.8k\Omega \quad (10)$$

Choose the closest standard value: 17.8k, 1% standard value resistor.

10.2.2.3 Undervoltage Lockout and Overvoltage Set Point

The undervoltage lockout (UVLO) and overvoltage trip point are adjusted using the external voltage divider network of R_1 , R_2 and R_3 as connected between IN, EN, OVP and GND pins of the TPS25942, TPS25944 devices. The values required for setting the undervoltage and overvoltage are calculated solving Equation 11 and Equation 12.

$$V_{(OVPR)} = \frac{R_3}{R_1 + R_2 + R_3} \times V_{(OV)}$$

where

- $V_{(OVPR)}$ = OVP Threshold for rising voltage (11)

$$V_{(ENR)} = \frac{R_2 + R_3}{R_1 + R_2 + R_3} \times V_{(UV)}$$

where

- $V_{(ENR)}$ = Enable threshold for rising voltage (12)

For minimizing the input current drawn from the power supply $\{I_{(R123)} = V_{(IN)}/(R_1 + R_2 + R_3)\}$, it is recommended to use higher values of resistance for R_1 , R_2 and R_3 .

However, leakage currents due to external active components connected to the resistor string can add error to these calculations. So, the resistor string current, $I_{(R123)}$ must be chosen to be 20x greater than the leakage current expected.

From the device electrical specifications, $V_{(OVPR)} = 0.99$ V and $V_{(ENR)} = 0.99$ V. For design requirements, $V_{(OV)}$ is 16.5 V and $V_{(UV)}$ is 10.8 V. To solve the equation, first choose the value of $R_3 = 31.2$ k Ω and use [Equation 11](#) to solve for $(R_1 + R_2) = 488.8$ k Ω . Use [Equation 12](#) and value of $(R_1 + R_2)$ to solve for $R_2 = 16.47$ k Ω and finally $R_1 = 472.33$ k Ω .

Using the closest standard 1% resistor values gives $R_1 = 475$ k Ω , $R_2 = 16.7$ k Ω , and $R_3 = 31.2$ k Ω .

The power fail threshold $V_{(PFAIL)}$ is detected on the falling edge of the power supply. The falling voltage threshold is 7% lower than the rising voltage threshold, so for a set $V_{(UV)}$ the power fail voltage $V_{(PFAIL)}$ is given by [Equation 13](#).

$$V_{(PFAIL)} = 0.93 \times V_{(UV)} \quad (13)$$

10.2.2.4 Programming Current Monitoring Resistor— $R_{(IMON)}$

Voltage at IMON pin $V_{(IMON)}$ represents the voltage proportional to load current. This can be connected to an ADC of the downstream system for health monitoring of the system. The $R_{(IMON)}$ need to be configured based on the maximum input voltage range of the ADC used. $R_{(IMON)}$ is set using [Equation 14](#).

$$R_{(IMON)} = \frac{V_{(IMONmax)}}{I_{(LIM)} \times 52 \times 10^{-6}} \text{ k}\Omega \quad (14)$$

For $I_{(LIM)} = 5$ A, and considering the operating range of ADC from 0 V to 5 V, $V_{(IMONmax)}$ is 5 V and $R_{(IMON)}$ is determined by [Equation 15](#):

$$R_{(IMON)} = \frac{5}{5 \times 52 \times 10^{-6}} = 19.23 \text{ k}\Omega \quad (15)$$

Selecting $R_{(IMON)}$ value less than determined by [Equation 15](#) ensures that ADC limits are not exceeded for maximum value of load current.

If the IMON pin voltage is not being digitized with an ADC, $R_{(IMON)}$ can be selected to produce a 1V/1A voltage at the IMON pin, using [Equation 14](#).

Choose closest 1 % standard value: 19.1 k Ω .

If current monitoring up to $I_{(FASTRIP)}$ is desired, $R_{(IMON)}$ can be reduced by a factor of 1.6, as in [Equation 6](#).

10.2.2.5 Setting Output Voltage Ramp Time (t_{dVdT})

For a successful design, the junction temperature of device must be kept below the absolute-maximum rating during both dynamic (start-up) and steady state conditions. Dynamic power stresses often are an order of magnitude greater than the static stresses, so it is important to determine the right start-up time and in-rush current limit required with system capacitance to avoid thermal shutdown during start-up with and without load.

The ramp-up capacitor $C_{(dVdT)}$ needed is calculated considering the two possible cases:

10.2.2.5.1 Case1: Start-Up Without Load: Only Output Capacitance $C_{(OUT)}$ Draws Current During Start-Up

During start-up, as the output capacitor charges, the voltage difference across the internal FET decreases, and the power dissipated decreases as well. Typical ramp-up of output voltage $V_{(OUT)}$ with inrush current limit of 1.2 A and power dissipated in the device during start-up is shown in [Figure 56](#). The average power dissipated in the device during start-up is equal to area of triangular plot (red curve in [Figure 57](#)) averaged over t_{dVdT} .

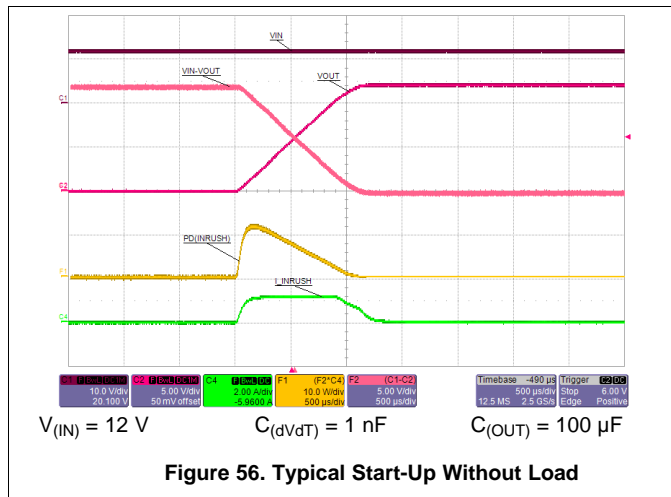

Figure 56. Typical Start-Up Without Load

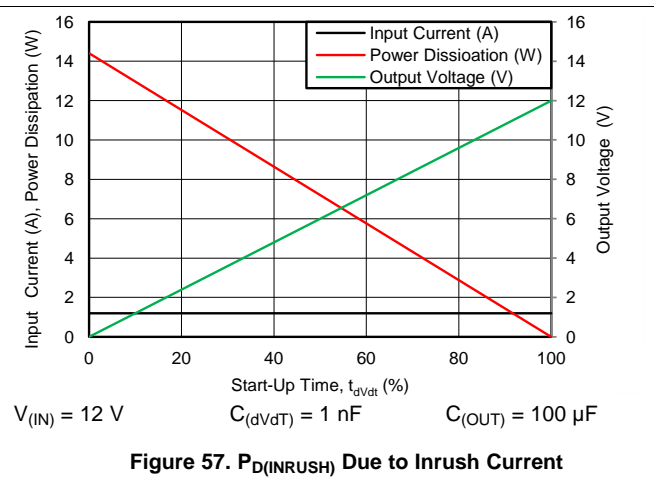

Figure 57. $P_{D(INRUSH)}$ Due to Inrush Current

For the TPS25944, TPS25944 device, the inrush current is determined as shown in Equation 16.

$$I = C \times \frac{dV}{dT} \Rightarrow I_{(INRUSH)} = C_{(OUT)} \times \frac{V_{(IN)}}{t_{dVdT}} \quad (16)$$

Power dissipation during start-up is given by Equation 17.

$$P_{D(INRUSH)} = 0.5 \times V_{(IN)} \times I_{(INRUSH)} \quad (17)$$

Equation 17 assumes that load does not draw any current until the output voltage has reached its final value.

10.2.2.5.2 Case 2: Start-Up With Load: Output Capacitance $C_{(OUT)}$ and Load Draws Current During Start-Up

When load draws current during the turn-on sequence, there is additional power dissipated. Considering a resistive load $R_{L(SU)}$ during start-up, load current ramps up proportionally with increase in output voltage during t_{dVdT} time. Typical ramp-up of output voltage, load current and power dissipated in the device is shown in Figure 58 and power dissipation with respect to time is plotted in Figure 59. The additional power dissipation during start-up phase is calculated as follows shown in Equation 18 and Equation 19.

$$(V_I - V_O)(t) = V_{(IN)} \times \left(1 - \frac{t}{t_{dVdT}}\right) \quad (18)$$

$$I_L(t) = \left(\frac{V_{(IN)}}{R_{L(SU)}}\right) \times \frac{t}{t_{dVdT}} \quad (19)$$

Where $R_{L(SU)}$ is the load resistance present during start-up. Average energy loss in internal FET during charging time due to resistive load is given by Equation 20.

$$W_t = \int_0^{t_{dVdT}} V_{(IN)} \times \left(1 - \frac{t}{t_{dVdT}}\right) \times \left(\frac{V_{(IN)}}{R_{L(SU)}} \times \frac{t}{t_{dVdT}}\right) dt \quad (20)$$

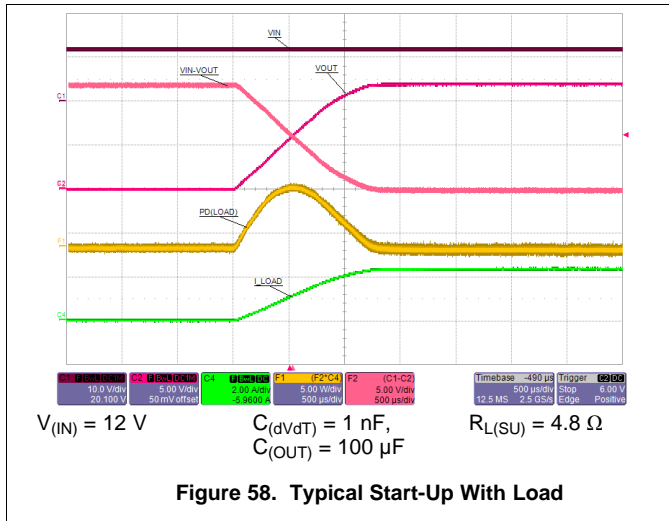

Figure 58. Typical Start-Up With Load

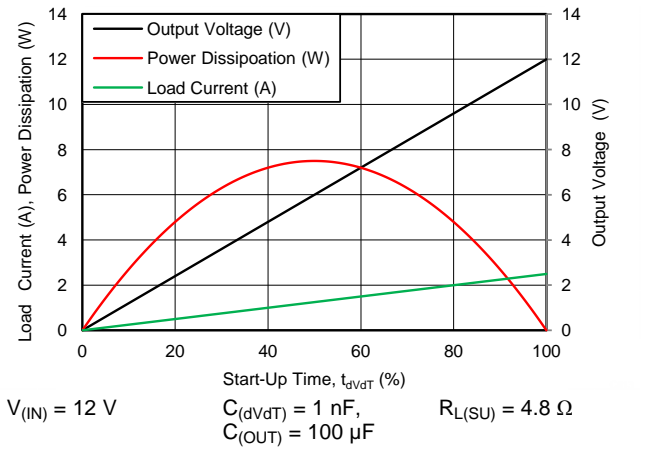

Figure 59. $P_{D(LOAD)}$ in Load During Start-Up

Solving Equation 20 the average power loss in the device due to load is given by Equation 21.

$$P_{D(LOAD)} = \left(\frac{1}{6}\right) \times \frac{V_{(IN)}^2}{R_{L(SU)}} \quad (21)$$

Total power dissipated in the device during start-up is given by Equation 22.

$$P_{D(STARTUP)} = P_{D(INRUSH)} + P_{D(LOAD)} \quad (22)$$

Total current during start-up is given by Equation 23.

$$I_{(STARTUP)} = I_{(INRUSH)} + I_L(t) \quad (23)$$

If $I_{(STARTUP)} > I_{(LIM)}$, the device limits the current to $I_{(LIM)}$ and the current limited charging time is determined by Equation 24.

$$t_{dVdT(\text{current limited})} = C_{(OUT)} \times \frac{V_{(IN)}}{I_{(LIM)}} \quad (24)$$

The power dissipation, with and without load, for selected start-up time must not exceed the shutdown limits as shown in Figure 60.

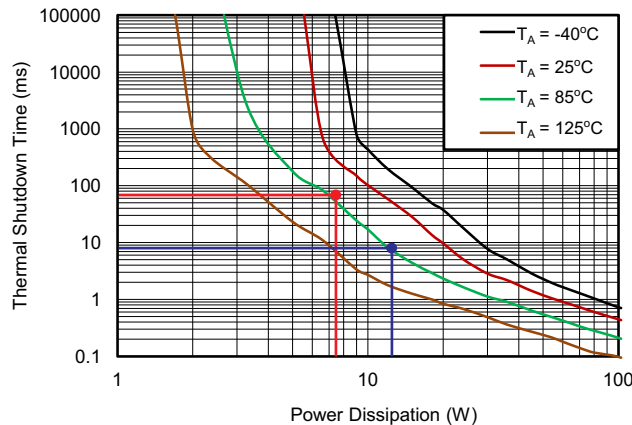

Taken on 2-Layer board, 2oz.(0.08-mm thick) with GND plane area: 14 cm² (Top) and 20 cm² (Bottom)

Figure 60. Thermal Shutdown Limit Plot

For the design example under discussion,

Select ramp-up capacitor $C_{(dVdT)} = 1\text{ nF}$, using Equation 2, we get Equation 25.

$$t_{dVdT} = 8.3 \times 10^4 \times 12 \times 1 \times 10^{-9} = 0.996\text{ms} = \sim 1\text{ms} \quad (25)$$

The inrush current drawn by the load capacitance ($C_{(OUT)}$) during ramp-up is calculated using [Equation 3](#) and [Equation 26](#).

$$I_{(INRUSH)} = \left(100 \times 10^{-6}\right) \times \left(\frac{12}{1 \times 10^{-3}}\right) = 1.2 \text{ A} \quad (26)$$

The inrush Power dissipation is calculated, using [Equation 17](#) and [Equation 27](#).

$$P_{D(INRUSH)} = 0.5 \times 12 \times 1.2 = 7.2 \text{ W} \quad (27)$$

For 7.2 W of power loss, the thermal shut down time of the device must not be less than the ramp-up time t_{dVdT} to avoid the false trip at maximum operating temperature. From thermal shutdown limit graph [Figure 60](#) at $T_A = 85^\circ\text{C}$, for 7.2 W of power the shutdown time is approximately 60 ms. So it is safe to use 1 ms as start-up time without any load on output.

Considering the start-up with load 4.8 Ω , the additional power dissipation, when load is present during start-up is calculated, using [Equation 21](#) and [Equation 28](#).

$$P_{D(Load)} = \left(\frac{1}{6}\right) \times \frac{12 \times 12}{4.8} = 5 \text{ W} \quad (28)$$

The total device power dissipation during start up is given by [Equation 29](#).

$$P_{D(STARTUP)} = (7.2 + 5) = 12.2 \text{ W} \quad (29)$$

From thermal shutdown limit graph at $T_A = 85^\circ\text{C}$, the thermal shutdown time for 12.2 W is close to 7.5 ms. It is safe to have 30% margin to allow for variation of system parameters such as load, component tolerance, and input voltage. So it is well within acceptable limits to use the 1 nF capacitor with start-up load of 4.8 Ω .

If there is a need to decrease the power loss during start-up, it can be done with increase of $C_{(dVdT)}$ capacitor.

To illustrate, choose $C_{(dVdT)} = 1.5 \text{ nF}$ as an option and recalculate as shown in [Equation 30](#) to [Equation 34](#).

$$t_{dVdT} = 1.5 \text{ ms} \quad (30)$$

$$I_{(INRUSH)} = \left(100 \times 10^{-6}\right) \times \left(\frac{12}{1.5 \times 10^{-3}}\right) = 0.8 \text{ A} \quad (31)$$

$$P_{D(INRUSH)} = 0.5 \times 12 \times 0.8 = 4.8 \text{ W} \quad (32)$$

$$P_{D(Load)} = \left(\frac{1}{6}\right) \times \left(\frac{12 \times 12}{4.8}\right) = 5 \text{ W} \quad (33)$$

$$P_{D(STARTUP)} = 4.8 + 5 = 9.8 \text{ W} \quad (34)$$

From thermal shutdown limit graph at $T_A = 85^\circ\text{C}$, the shutdown time for 10 W power dissipation is approximately 17 ms, which increases the margins further for shutdown time and ensures successful operation during start-up and steady state conditions.

The spreadsheet tool available on the web can be used for iterative calculations.

10.2.2.6 Programming the Power Good Set Point

As shown in [Figure 55](#), R_4 and R_5 sets the required limit for PGOOD signal as needed for the downstream converters. Considering a power good threshold of 11 V for this design, the values of R_4 and R_5 are calculated using [Equation 35](#).

$$V_{(PGTH)} = 0.99 \times \left(1 + \frac{R_4}{R_5}\right) \quad (35)$$

It is recommended to have high values for these resistors to limit the current drawn from the output node. Choosing a value of $R_4 = 475 \text{ k}\Omega$, $R_5 = 47 \text{ k}\Omega$ provides $V_{(PGTH)} = 11 \text{ V}$.

10.2.2.7 Support Component Selections— R_6 , R_7 and C_{IN}

Reference to application schematics, R_6 and R_7 are required only if PGOOD and $\overline{\text{FLT}}$ are used; these resistors serve as pull-ups for the open-drain output drivers. The current sunk by each of these pins must not exceed 10 mA (see the [Absolute Maximum Ratings](#) table). C_{IN} is a bypass capacitor to help control transient voltages, unit emissions, and local supply noise. Where acceptable, a value in the range of 0.001 μF to 0.1 μF is recommended for C_{IN} .

10.2.3 Application Curves

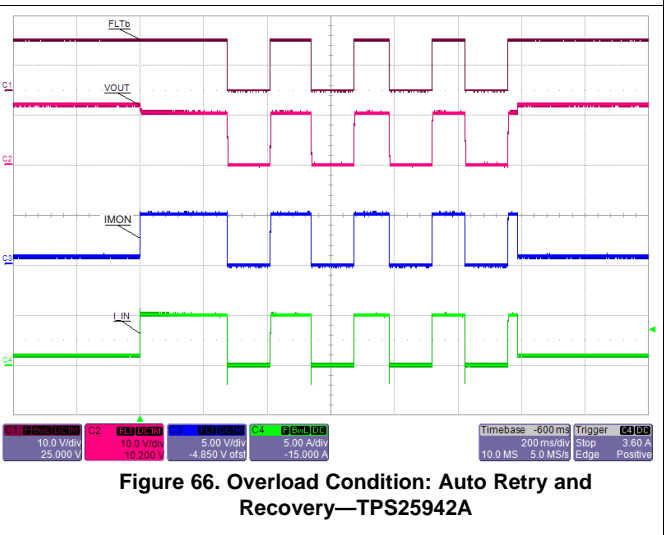
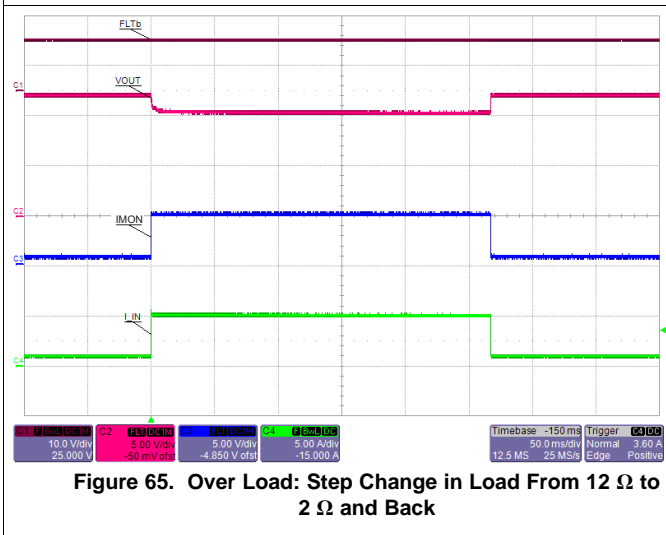
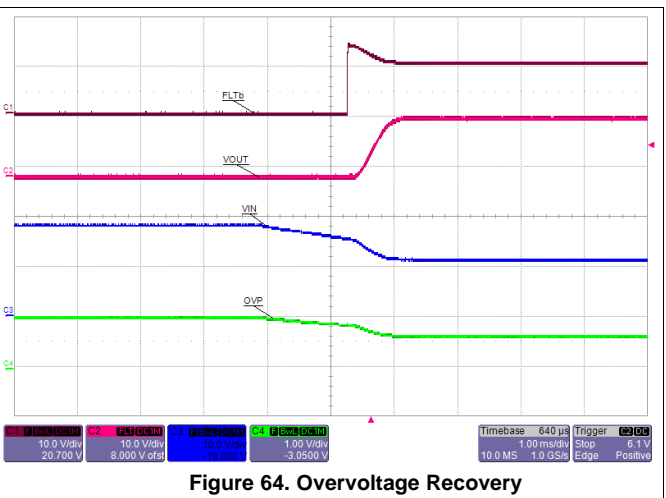
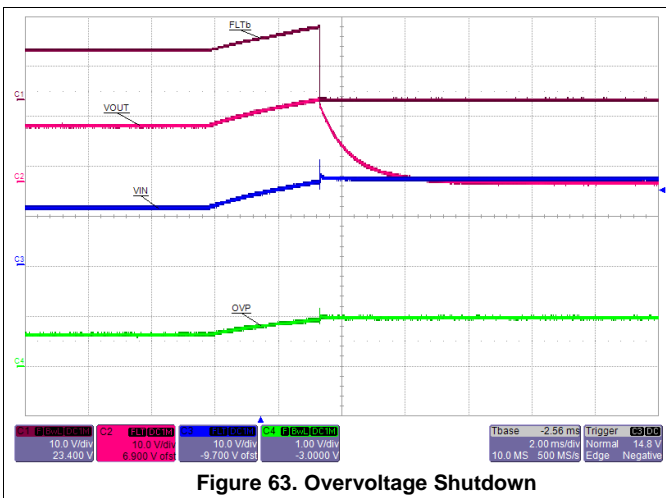
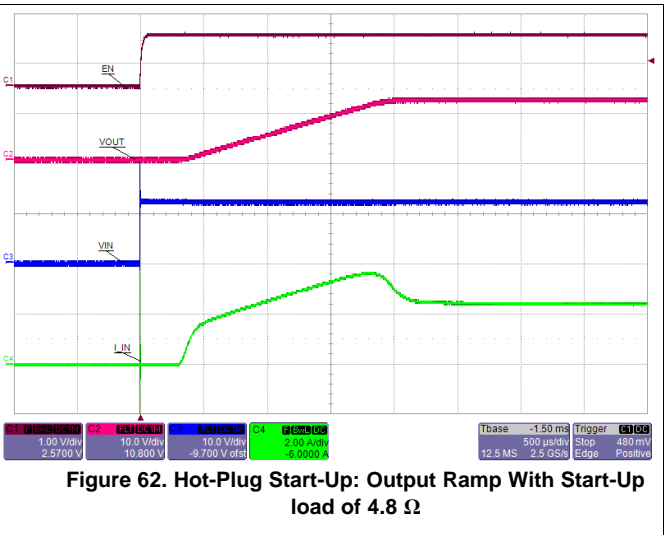
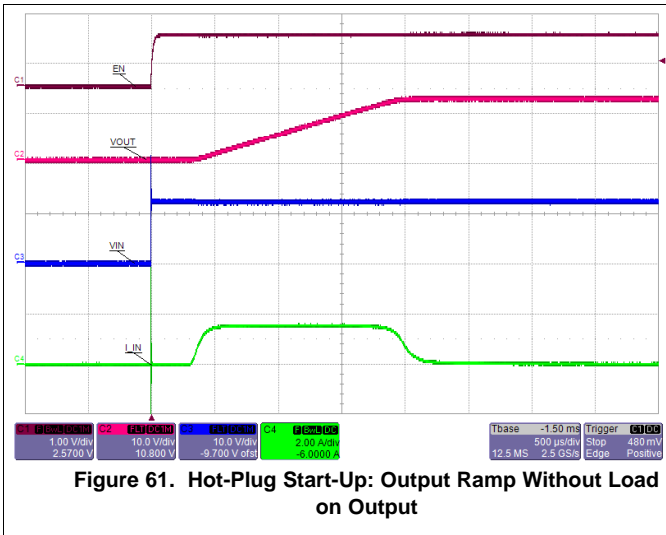

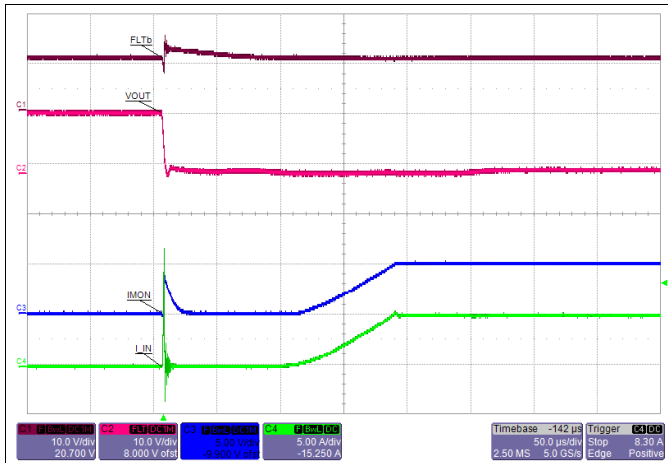

Figure 67. Hot Short: Fast Trip and Current Regulation

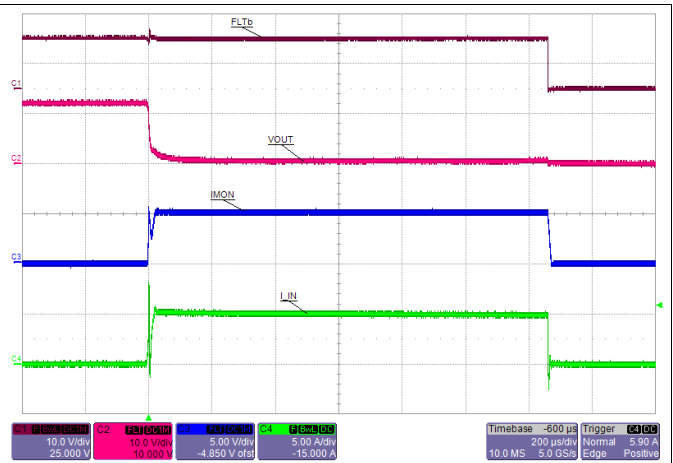

Figure 68. Hot Short: Latched—TPS25942L

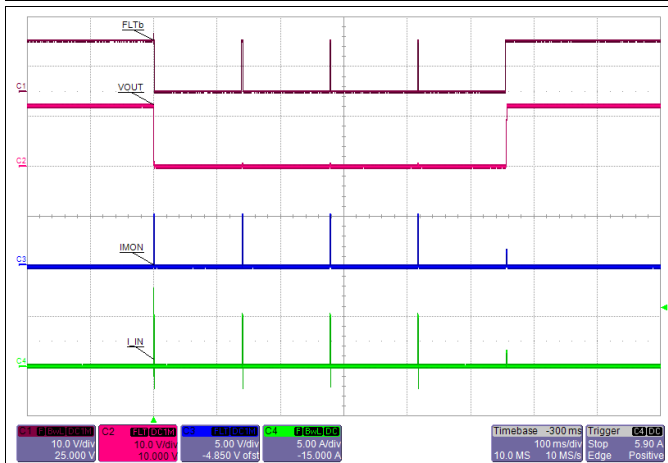

Figure 69. Hot Short: Auto-Retry and Recovery from Short Circuit—TPS25942A

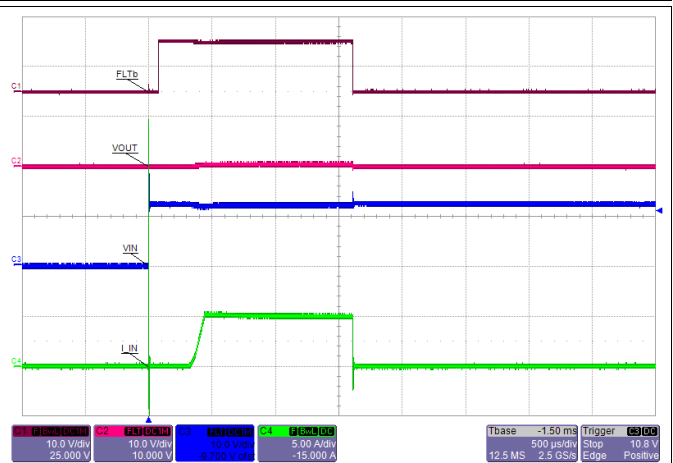

Figure 70. Hot Plug-In with Short on Output: Latched—TPS25942L

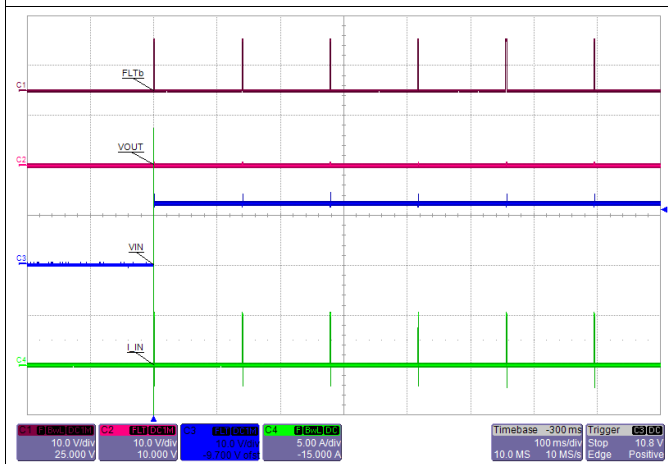

Figure 71. Hot Plug-In With Short on Output: Auto-Retry—TPS25942A

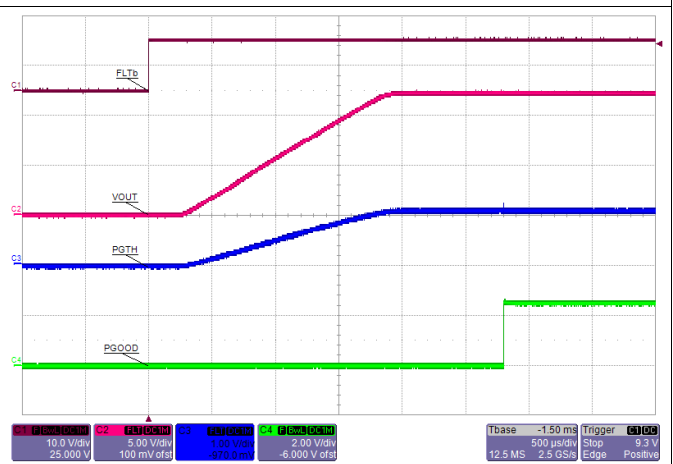
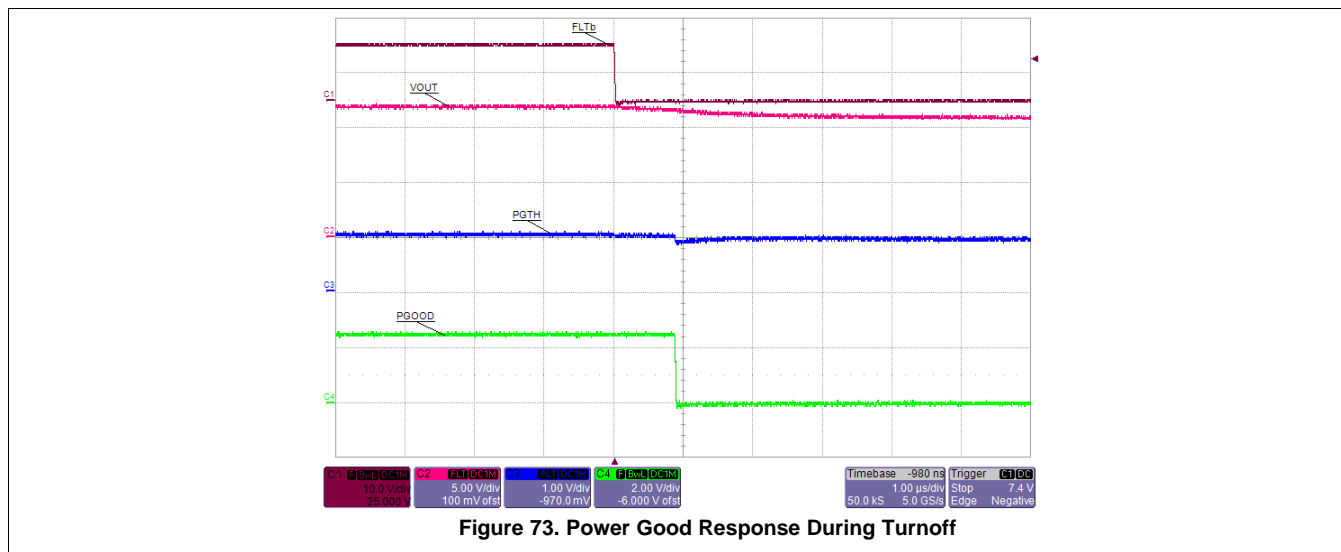

Figure 72. Power Good Response During Turnon



10.3 System Examples

The TPS25942 and TPS25944 provide a simple solution for power multiplexing applications through seamless transition between two power supplies, each operating at 2.7 V to 18 V and delivering up to 5 A. The devices with a distinctive feature set of true-reverse blocking, auto-forward conduction and fast switch over, support applications for both Active ORing and Priority power multiplexing.

10.3.1 Active ORing (Auto-Power Multiplexer) Operation

A typical redundant power supply configuration of the system is shown in [Figure 74](#). Schottky ORing diodes have been popular for connecting parallel power supplies, such as parallel operation of wall adapter with a battery or a hold-up storage capacitor. The disadvantage of using ORing diodes is high voltage drop and associated power loss. The TPS25942 and TPS25944 with an integrated, low-ohmic N-channel FET provide a simple and efficient solution. [Figure 74](#) shows the Active ORing implementation using the devices.

System Examples (continued)

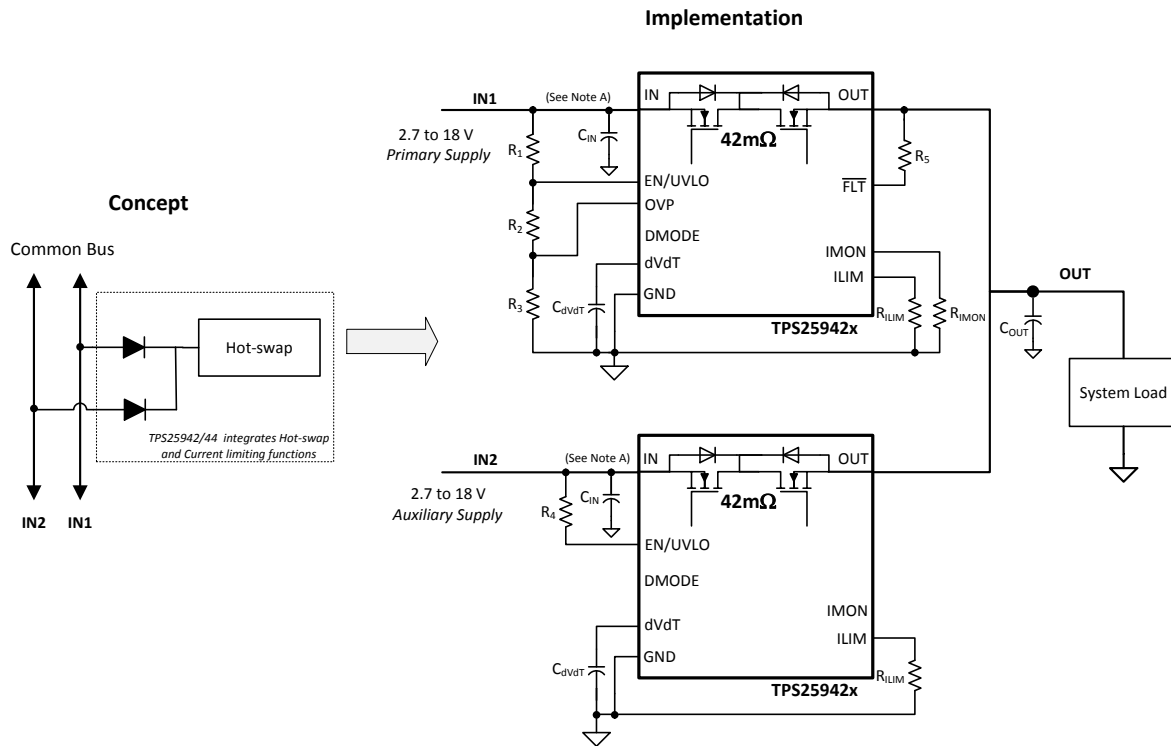

A. C_{IN} : Optional and only for noise suppression.

Figure 74. Active ORing Implementation

A fast reverse comparator controls the internal FET and it is turned ON or OFF with hysteresis as shown in Figure 75. The internal FET is turned ON in less than 4 μ s (typical) when the forward voltage drop $V_{(IN)} - V_{(OUT)}$ exceeds 100 mV and is turned off in 1 μ s (typical) as soon as $V_{(IN)} - V_{(OUT)}$ falls below -10 mV. When internal FET is turned ON, the ORed input supply experiences momentary in-rush current drawn as the FET turns on charging the bus capacitance. In addition, device can be operated in Diode Mode by independently controlling DMODE pin.

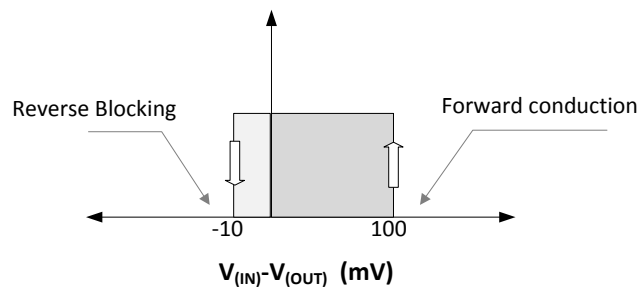
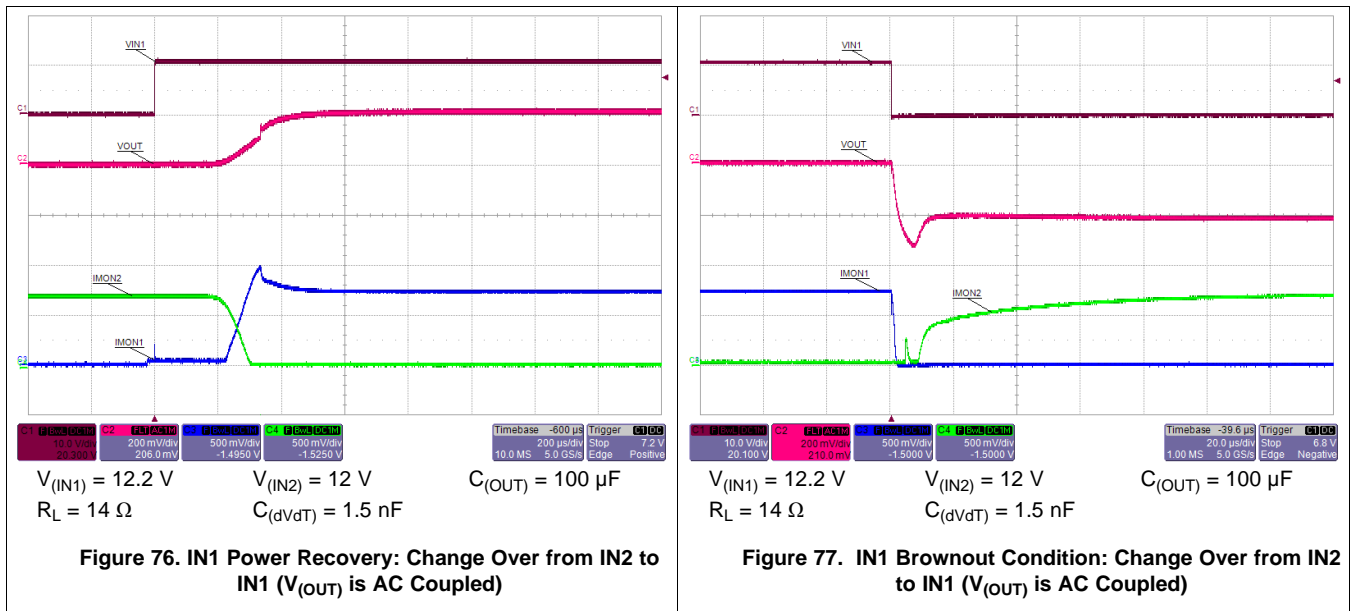

Figure 75. Active ORing Thresholds

Figure 75 shows typical switch-over waveforms of Active ORing implementation using the TPS25942 or TPS25944.

System Examples (continued)



When bus voltages (IN1 and IN2) are matched, device in each rail sees a forward voltage drop and is ON delivering the load current. During this period, current is shared between the rails in the ratio of differential voltage drop across each device.

In addition to above, the devices provide inrush current limit and protects each rail from potential overload and short circuit faults.

10.3.1.1 N+1 Power Supply Operation

The devices can be used to combine multiple power supplies to a common bus in an N+1 configuration. The N+1 power supply configuration as shown in Figure 78, is used where multiple power supplies are paralleled for either higher capacity, redundancy or both. If it takes N supplies to power the load, adding an extra identical unit in parallel permits the load to continue operation in the event that any one of the N supplies fails. The devices emulate the function of the ORing diode and provides with all protections as needed to isolate the rail during hot-plug, overvoltage, undervoltage, overcurrent and short-circuit conditions.

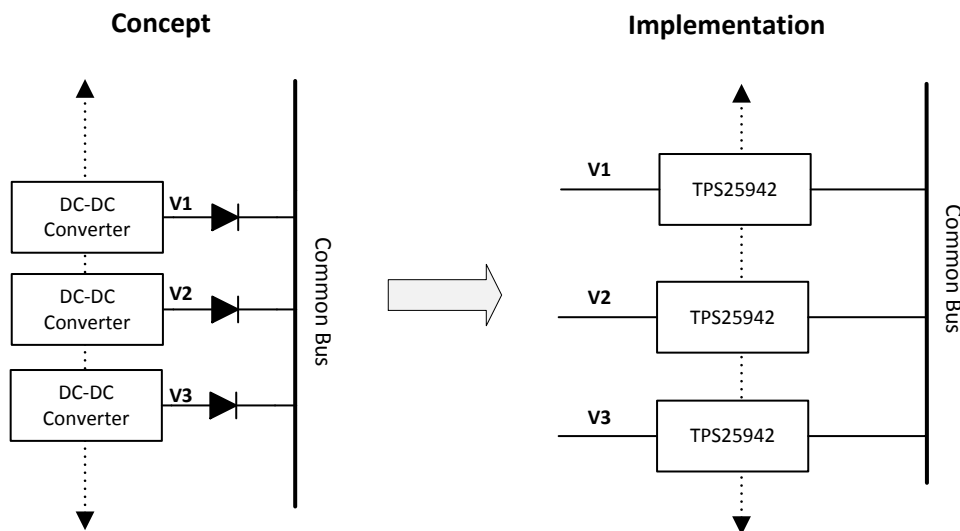

Figure 78. N+1 Configuration Implementation

System Examples (continued)

10.3.1.2 Priority Power MUX Operation

Applications having two energy sources such as PCIe cards, Tablets and Portable battery powered equipment require preference of one source to another. For example, mains power (wall-adaptor) has the priority over the internal back-up power or auxiliary power. These applications demand for switch over from mains power to back-up power only when main input voltage falls below a user defined threshold. The devices provide a simple solution for priority power multiplexing needs.

Figure 79 shows a typical priority power multiplexing implementation using devices. When primary power IN1 is present, the device in IN1 path powers the OUT bus irrespective of whether auxiliary power IN2 is greater than or less than IN1. Once the voltage on the IN1 rail falls below the user-defined threshold, the device IN1 issues a signal to switch over to auxiliary power IN2. The transition happens seamlessly in less than 125 μs , with minimal voltage droop on the bus. The voltage droop during transition is a function of load current and bus capacitance (see Equation 36).

$$V_{(\text{droop})} = \frac{I_{(\text{Load})} \times 125 \mu\text{s}}{C_{(\text{BUS})}}$$

where

- $V_{(\text{droop})}$ in Volts, $I_{(\text{Load})}$ is load current in Ampere, $C_{(\text{BUS})}$ is bus capacitance in μF (36)

When the main voltage supply (IN1) is not present or during brown-out conditions, the device in auxiliary supply rail (IN2) provides power to the output. When IN1 recovers, the device connected to IN1 is turned on at defined slew rate and the device in IN2 path is turned off, allowing a seamless transition from auxiliary to the main voltage supply with minimal droop and with no shoot-through current.

Priority power multiplexing can be done either between two similar rails (such as 12 V Primary to 12 V Aux, 3.3 V Primary to 3.3 V Aux) or between dissimilar rails (such as 12 V Primary to 5 V Aux or 3.3 V Aux; or vice versa).

System Examples (continued)

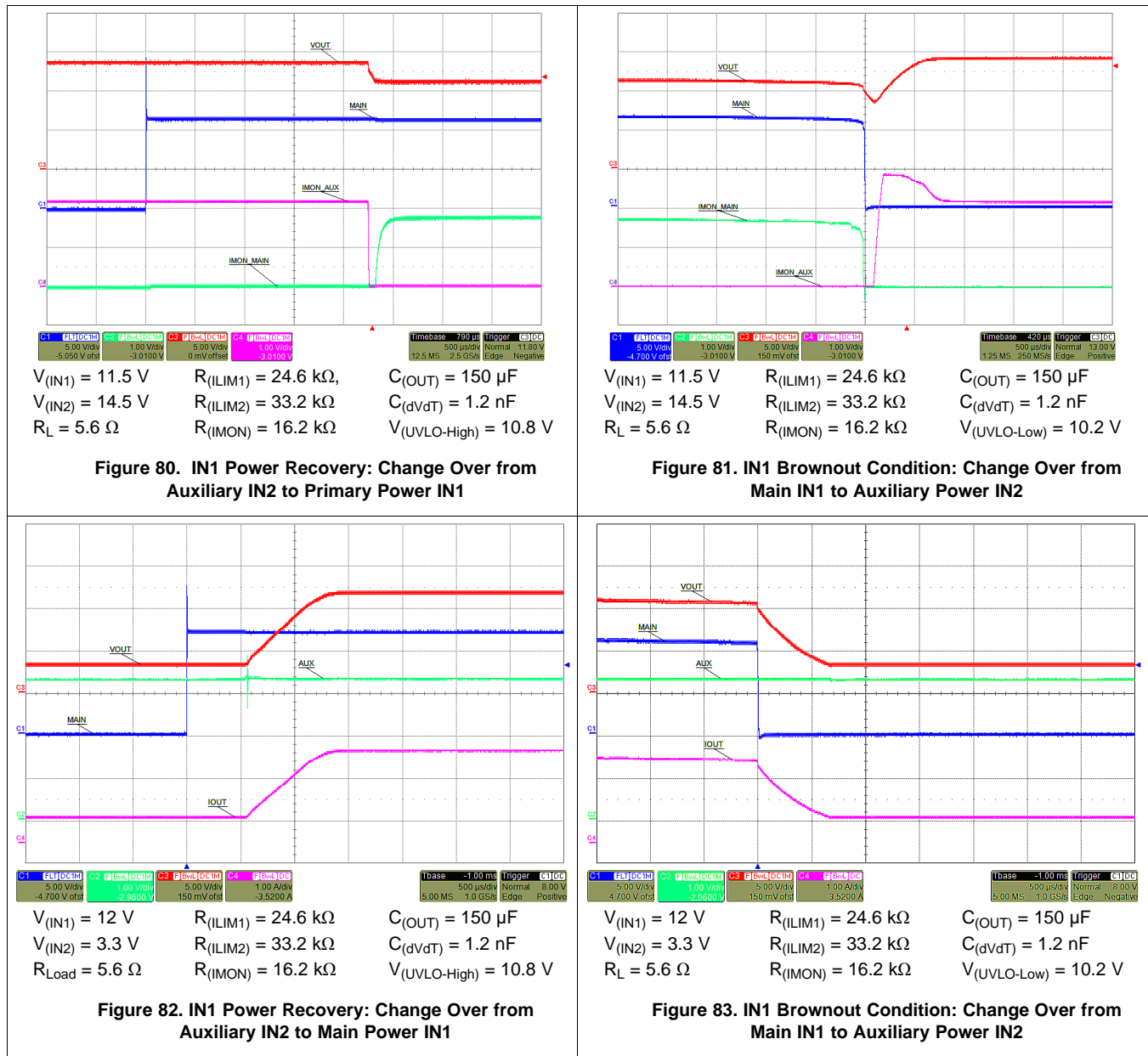

10.3.1.3 Priority MUXing With Almost Equal Rails ($V_{IN1} \sim V_{IN2}$)

Most of the redundant power supply systems used in servers, storage and telecom, multiplex tightly regulated power rails to provide uninterrupted power to the load. In these systems, the primary and auxiliary rails are close to each other, typically within one diode drop when both rails are active.

For priority multiplexing in these systems, the TPS25942 or TPS25944 device in auxiliary rail path can be operated in *Diode Mode* for a fast switch-over (1 μs typical). The fast switch-over reduces the required hold-up capacitor on the output rail for a given droop specification.

The circuit implementation of this configuration is shown in [Figure 84](#). During power-fail (brown-out) conditions of primary rail IN1, it changes IN2 from 'Diode-Mode' to normal operation using PGOOD. Similarly during power recovery of primary rail IN1, the auxiliary rail IN2 is driven into 'Diode-Mode'.

System Examples (continued)

10.3.1.4 Reverse Polarity Protection

In applications demanding reverse polarity or reverse battery protection, the TPS25942 and TPS25944 can be used as an eFuse or ideal diode. A typical reverse polarity protection circuitry is shown in Figure 86. The signal diode in the GND terminal path ensures that device is not functional during reverse polarity conditions and internal FET blocks the reverse path.

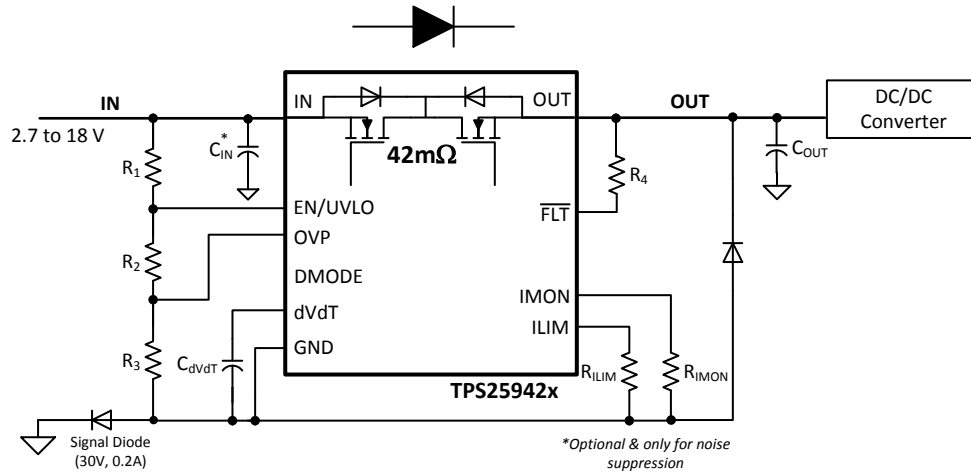

Figure 86. Reverse Polarity Protection Implementation

11 Power Supply Recommendations

The devices are designed for supply voltage range of $2.7\text{ V} \leq V_{IN} \leq 18\text{ V}$. If the input supply is located more than a few inches from the device an input ceramic bypass capacitor higher than $0.1\text{ }\mu\text{F}$ is recommended. Power supply must be rated higher than the current limit set to avoid voltage droops during over current and short-circuit conditions.

11.1 Transient Protection

In case of short circuit and over load current limit, when the device interrupts current flow, input inductance generates a positive voltage spike on the input and output inductance generates a negative voltage spike on the output. The peak amplitude of voltage spikes (transients) is dependent on value of inductance in series to the input or output of the device. Such transients can exceed the *Absolute Maximum Ratings* of the device if steps are not taken to address the issue.

Typical methods for addressing transients include

- Minimizing lead length and inductance into and out of the device
- Using large PCB GND plane
- Schottky diode across the output to absorb negative spikes
- A low value ceramic capacitor ($C_{(IN)} = 0.001\text{ }\mu\text{F}$ to $0.1\text{ }\mu\text{F}$) to absorb the energy and dampen the transients. The approximate value of input capacitance can be estimated with Equation 37.

$$V_{\text{SPIKE(Absolute)}} = V_{(IN)} + I_{(LOAD)} \times \sqrt{\frac{L_{(IN)}}{C_{(IN)}}}$$

where

- $V_{(IN)}$ is the nominal supply voltage
- $I_{(LOAD)}$ is the load current,
- $L_{(IN)}$ equals the effective inductance seen looking into the source
- $C_{(IN)}$ is the capacitance present at the input

(37)

Transient Protection (continued)

Some applications may require the addition of a Transient Voltage Suppressor (TVS) to prevent transients from exceeding the *Absolute Maximum Ratings* of the device.

The circuit implementation with optional protection components (a ceramic capacitor, TVS and schottky diode) is shown in [Figure 87](#).

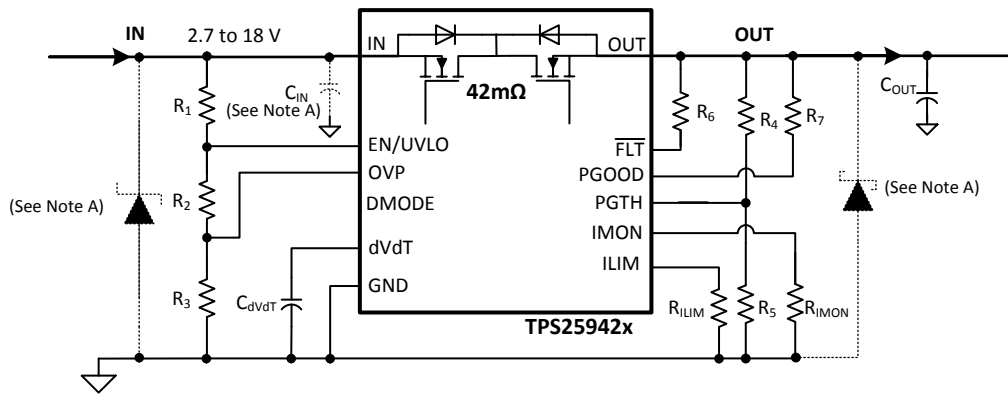

A. Optional components needed for suppression of transients

Figure 87. Circuit Implementation With Optional Protection Components

11.2 Output Short-Circuit Measurements

It is difficult to obtain repeatable and similar short-circuit testing results. Source bypassing, input leads, circuit layout and component selection, output shorting method, relative location of the short, and instrumentation all contribute to variation in results. The actual short itself exhibits a certain degree of randomness as it microscopically bounces and arcs. Care in configuration and methods must be used to obtain realistic results. Do not expect to see waveforms exactly like those in the data sheet; every setup differs.

12 Layout

12.1 Layout Guidelines

- For all applications, a 0.1- μ F or greater ceramic decoupling capacitor is recommended between IN terminal and GND. For hot-plug applications, where input power path inductance is negligible, this capacitor can be eliminated or minimized.
- The optimum placement of decoupling capacitor is closest to the IN and GND terminals of the device. Care must be taken to minimize the loop area formed by the bypass-capacitor connection, the IN terminal, and the GND terminal of the IC. See [Figure 88](#) for a PCB layout example.
- High current carrying power path connections must be as short as possible and must be sized to carry at least twice the full-load current.
- Low current signal ground (SGND), which is the reference ground for the device must be a copper plane or island.
- Locate all the TPS25942, TPS25944 support components: $R_{(ILIM)}$, C_{dVdT} , $R_{(IMON)}$, and resistors for UVLO and OVP, close to their connection pin. Connect the other end of the component to the SGND with shortest trace length.
- The trace routing for the $R_{(ILIM)}$ and $R_{(IMON)}$ components to the device must be as short as possible to reduce parasitic effects on the current limit and current monitoring accuracy. These traces must not have any coupling to switching signals on the board.
- The SGND plane must be connected to high current ground (main power ground) at a single point, that is at the negative terminal of input capacitor.
- Protection devices such as TVS, snubbers, capacitors, or diodes must be placed physically close to the device they are intended to protect, and routed with short traces to reduce inductance. For example, a protection Schottky diode is recommended to address negative transients due to switching of inductive loads, and it must be physically close to the OUT pins.
- Thermal Considerations: When properly mounted the PowerPAD™ package provides significantly greater cooling ability than an ordinary package. To operate at rated power, the PowerPAD must be soldered directly to the board GND plane directly under the device. The PowerPAD is at GND potential and can be connected using multiple vias to inner layer GND. Other planes, such as the bottom side of the circuit board can be used to increase heat sinking in higher current applications. See the Technical Briefs: PowerPad™ Thermally Enhanced Package ([SLMA002](#)) and PowerPAD™ Made Easy ([SLMA004](#)) for more information on using this PowerPAD™ package.
- The thermal via land pattern specific to the TPS25942, TPS25944 can be downloaded from [device webpage](#).
- Obtaining acceptable performance with alternate layout schemes is possible; however this layout has been shown to produce good results and is intended as a guideline.

12.2 Layout Example

- Top layer
- Top layer signal ground plane
- Bottom layer signal ground plane
- Via to signal ground plane

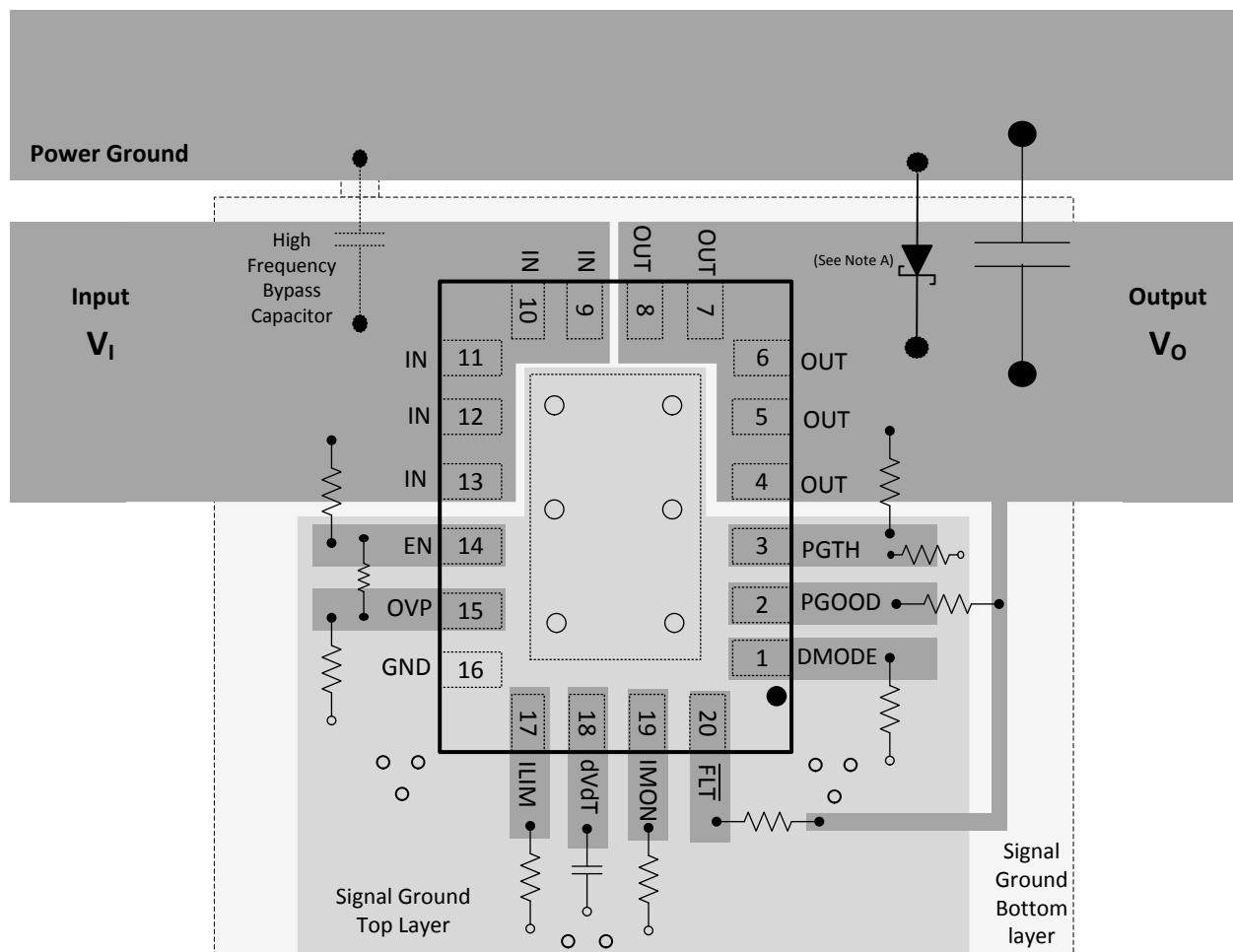

A. Optional: Needed only to suppress the transients caused by inductive load switching.

Figure 88. Board Layout

13 Device and Documentation Support

13.1 Device Support

For the TPS25942A PSpice Transient Model, see [SLVMAA3B](#).

For the TPS25942L PSpice Transient Model, see [SLVMAA4A](#).

13.2 Documentation Support

13.2.1 Related Documentation

For related documentation see the following:

- [Reduce Diode Losses in Redundant Systems With Integrated Power MUXes](#)
- [TPS25942x635EVM: Evaluation Module For TPS25942x User's Guide](#)
- [TPS25944X635EVM: Evaluation Module for TPS25944X](#)
- [Power Multiplexing Using Load Switches and eFuses](#)

13.3 Related Links

The table below lists quick access links. Categories include technical documents, support and community resources, tools and software, and quick access to sample or buy.

Table 3. Related Links

PARTS	PRODUCT FOLDER	SAMPLE & BUY	TECHNICAL DOCUMENTS	TOOLS & SOFTWARE	SUPPORT & COMMUNITY
TPS25942A	Click here	Click here	Click here	Click here	Click here
TPS25942L	Click here	Click here	Click here	Click here	Click here
TPS25944A	Click here	Click here	Click here	Click here	Click here
TPS25944L	Click here	Click here	Click here	Click here	Click here

13.4 Receiving Notification of Documentation Updates

To receive notification of documentation updates, navigate to the device product folder on ti.com. In the upper right corner, click on *Alert me* to register and receive a weekly digest of any product information that has changed. For change details, review the revision history included in any revised document.

13.5 Community Resources

The following links connect to TI community resources. Linked contents are provided "AS IS" by the respective contributors. They do not constitute TI specifications and do not necessarily reflect TI's views; see TI's [Terms of Use](#).

TI E2E™ Online Community *TI's Engineer-to-Engineer (E2E) Community*. Created to foster collaboration among engineers. At e2e.ti.com, you can ask questions, share knowledge, explore ideas and help solve problems with fellow engineers.

Design Support *TI's Design Support* Quickly find helpful E2E forums along with design support tools and contact information for technical support.

13.6 Trademarks

E2E is a trademark of Texas Instruments.
All other trademarks are the property of their respective owners.

13.7 Electrostatic Discharge Caution



These devices have limited built-in ESD protection. The leads should be shorted together or the device placed in conductive foam during storage or handling to prevent electrostatic damage to the MOS gates.

13.8 Glossary

[SLYZ022](#) — *TI Glossary*.

This glossary lists and explains terms, acronyms, and definitions.

14 Mechanical, Packaging, and Orderable Information

The following pages include mechanical, packaging, and orderable information. This information is the most current data available for the designated devices. This data is subject to change without notice and revision of this document. For browser-based versions of this data sheet, refer to the left-hand navigation.

PACKAGING INFORMATION

Orderable Device	Status (1)	Package Type	Package Drawing	Pins	Package Qty	Eco Plan (2)	Lead/Ball Finish (6)	MSL Peak Temp (3)	Op Temp (°C)	Device Marking (4/5)	Samples
TPS25942ARVCR	ACTIVE	WQFN	RVC	20	3000	Green (RoHS & no Sb/Br)	CU NIPDAU	Level-2-260C-1 YEAR	-40 to 85	25942A	Samples
TPS25942ARVCT	ACTIVE	WQFN	RVC	20	250	Green (RoHS & no Sb/Br)	CU NIPDAU	Level-2-260C-1 YEAR	-40 to 85	25942A	Samples
TPS25942LRVCR	ACTIVE	WQFN	RVC	20	3000	Green (RoHS & no Sb/Br)	CU NIPDAU	Level-2-260C-1 YEAR	-40 to 125	25942L	Samples
TPS25942LRVCT	ACTIVE	WQFN	RVC	20	250	Green (RoHS & no Sb/Br)	CU NIPDAU	Level-2-260C-1 YEAR	-40 to 125	25942L	Samples
TPS25944ARVCR	ACTIVE	WQFN	RVC	20	3000	Green (RoHS & no Sb/Br)	CU NIPDAU	Level-2-260C-1 YEAR	-40 to 85	25944A	Samples
TPS25944ARVCT	ACTIVE	WQFN	RVC	20	250	Green (RoHS & no Sb/Br)	CU NIPDAU	Level-2-260C-1 YEAR	-40 to 85	25944A	Samples
TPS25944LRVCR	ACTIVE	WQFN	RVC	20	3000	Green (RoHS & no Sb/Br)	CU NIPDAU	Level-2-260C-1 YEAR	-40 to 85	25944L	Samples
TPS25944LRVCT	ACTIVE	WQFN	RVC	20	250	Green (RoHS & no Sb/Br)	CU NIPDAU	Level-2-260C-1 YEAR	-40 to 85	25944L	Samples

(1) The marketing status values are defined as follows:

ACTIVE: Product device recommended for new designs.

LIFEBUY: TI has announced that the device will be discontinued, and a lifetime-buy period is in effect.

NRND: Not recommended for new designs. Device is in production to support existing customers, but TI does not recommend using this part in a new design.

PREVIEW: Device has been announced but is not in production. Samples may or may not be available.

OBSELETE: TI has discontinued the production of the device.

(2) **RoHS:** TI defines "RoHS" to mean semiconductor products that are compliant with the current EU RoHS requirements for all 10 RoHS substances, including the requirement that RoHS substance do not exceed 0.1% by weight in homogeneous materials. Where designed to be soldered at high temperatures, "RoHS" products are suitable for use in specified lead-free processes. TI may reference these types of products as "Pb-Free".

RoHS Exempt: TI defines "RoHS Exempt" to mean products that contain lead but are compliant with EU RoHS pursuant to a specific EU RoHS exemption.

Green: TI defines "Green" to mean the content of Chlorine (Cl) and Bromine (Br) based flame retardants meet JS709B low halogen requirements of <=100ppm threshold. Antimony trioxide based flame retardants must also meet the <=1000ppm threshold requirement.

(3) MSL, Peak Temp. - The Moisture Sensitivity Level rating according to the JEDEC industry standard classifications, and peak solder temperature.

(4) There may be additional marking, which relates to the logo, the lot trace code information, or the environmental category on the device.

⁽⁵⁾ Multiple Device Markings will be inside parentheses. Only one Device Marking contained in parentheses and separated by a "-" will appear on a device. If a line is indented then it is a continuation of the previous line and the two combined represent the entire Device Marking for that device.

⁽⁶⁾ Lead/Ball Finish - Orderable Devices may have multiple material finish options. Finish options are separated by a vertical ruled line. Lead/Ball Finish values may wrap to two lines if the finish value exceeds the maximum column width.

Important Information and Disclaimer:The information provided on this page represents TI's knowledge and belief as of the date that it is provided. TI bases its knowledge and belief on information provided by third parties, and makes no representation or warranty as to the accuracy of such information. Efforts are underway to better integrate information from third parties. TI has taken and continues to take reasonable steps to provide representative and accurate information but may not have conducted destructive testing or chemical analysis on incoming materials and chemicals. TI and TI suppliers consider certain information to be proprietary, and thus CAS numbers and other limited information may not be available for release.

In no event shall TI's liability arising out of such information exceed the total purchase price of the TI part(s) at issue in this document sold by TI to Customer on an annual basis.

TAPE AND REEL INFORMATION

QUADRANT ASSIGNMENTS FOR PIN 1 ORIENTATION IN TAPE

*All dimensions are nominal

Device	Package Type	Package Drawing	Pins	SPQ	Reel Diameter (mm)	Reel Width W1 (mm)	A0 (mm)	B0 (mm)	K0 (mm)	P1 (mm)	W (mm)	Pin1 Quadrant
TPS25942ARVCR	WQFN	RVC	20	3000	330.0	12.4	3.3	4.3	1.1	8.0	12.0	Q1
TPS25942ARVCT	WQFN	RVC	20	250	180.0	12.4	3.3	4.3	1.1	8.0	12.0	Q1
TPS25942LRVCR	WQFN	RVC	20	3000	330.0	12.4	3.3	4.3	1.1	8.0	12.0	Q1
TPS25942LRVCT	WQFN	RVC	20	250	180.0	12.4	3.3	4.3	1.1	8.0	12.0	Q1
TPS25944ARVCR	WQFN	RVC	20	3000	330.0	12.4	3.3	4.3	1.1	8.0	12.0	Q1
TPS25944ARVCT	WQFN	RVC	20	250	180.0	12.4	3.3	4.3	1.1	8.0	12.0	Q1
TPS25944LRVCR	WQFN	RVC	20	3000	330.0	12.4	3.3	4.3	1.1	8.0	12.0	Q1
TPS25944LRVCT	WQFN	RVC	20	250	180.0	12.4	3.3	4.3	1.1	8.0	12.0	Q1

TAPE AND REEL BOX DIMENSIONS

*All dimensions are nominal

Device	Package Type	Package Drawing	Pins	SPQ	Length (mm)	Width (mm)	Height (mm)
TPS25942ARVCR	WQFN	RVC	20	3000	367.0	367.0	35.0
TPS25942ARVCT	WQFN	RVC	20	250	210.0	185.0	35.0
TPS25942LRVCR	WQFN	RVC	20	3000	367.0	367.0	35.0
TPS25942LRVCT	WQFN	RVC	20	250	210.0	185.0	35.0
TPS25944ARVCR	WQFN	RVC	20	3000	367.0	367.0	35.0
TPS25944ARVCT	WQFN	RVC	20	250	210.0	185.0	35.0
TPS25944LRVCR	WQFN	RVC	20	3000	367.0	367.0	35.0
TPS25944LRVCT	WQFN	RVC	20	250	210.0	185.0	35.0

RVC (R-PWQFN-N20)

PLASTIC QUAD FLATPACK NO-LEAD

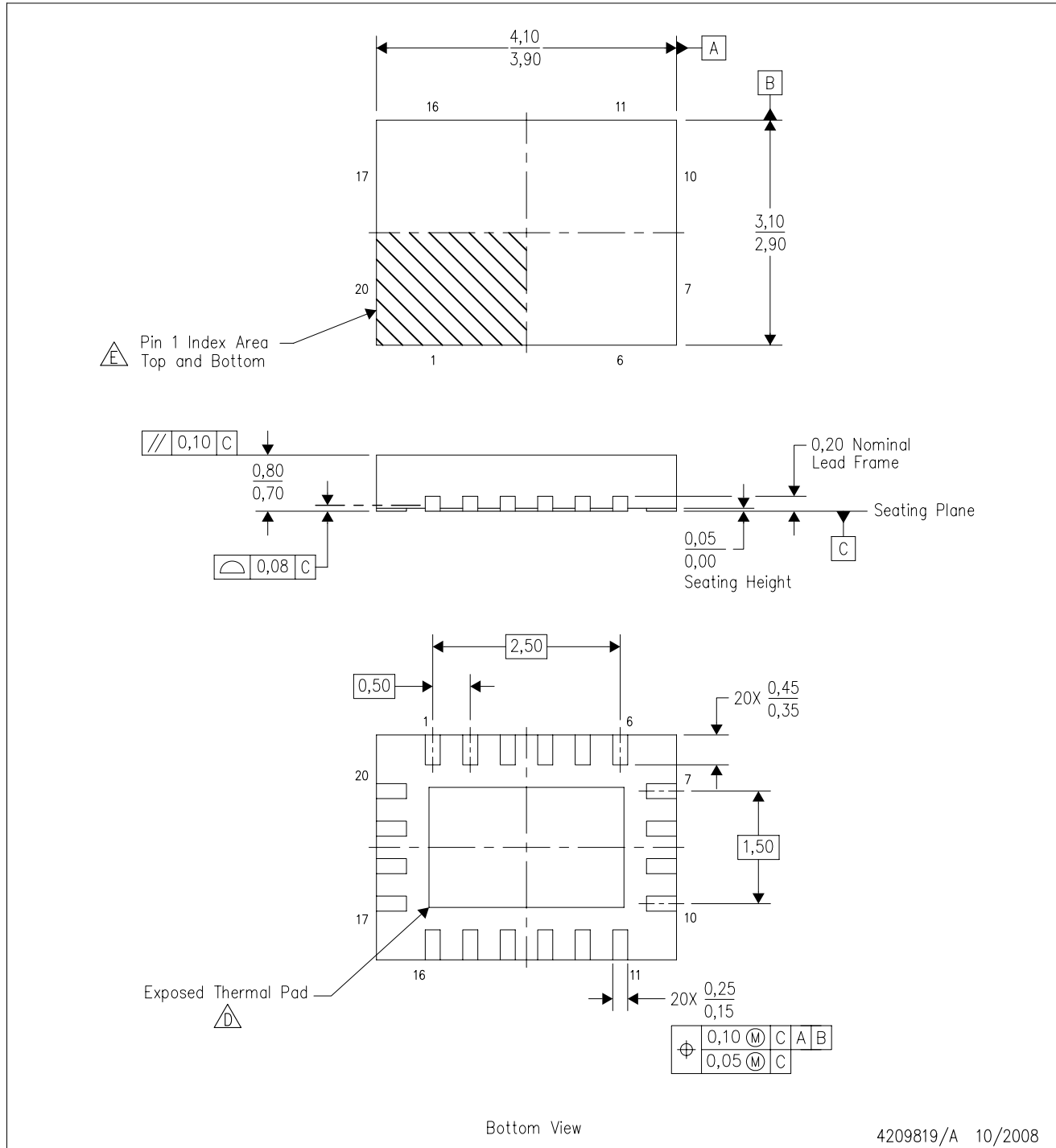

- NOTES:
- All linear dimensions are in millimeters. Dimensioning and tolerancing per ASME Y14.5M-1994.
 - This drawing is subject to change without notice.
 - QFN (Quad Flatpack No-Lead) package configuration.
- D** The package thermal pad must be soldered to the board for thermal and mechanical performance. See the Product Data Sheet for details regarding the exposed thermal pad dimensions.
- E** Pin 1 identifiers are located on both top and bottom of the package and within the zone indicated. The Pin 1 identifiers are either a molded, marked, or metal feature.

THERMAL PAD MECHANICAL DATA

RVC (R-PWQFN-N20)

PLASTIC QUAD FLATPACK NO-LEAD

THERMAL INFORMATION

This package incorporates an exposed thermal pad that is designed to be attached directly to an external heatsink. The thermal pad must be soldered directly to the printed circuit board (PCB). After soldering, the PCB can be used as a heatsink. In addition, through the use of thermal vias, the thermal pad can be attached directly to the appropriate copper plane shown in the electrical schematic for the device, or alternatively, can be attached to a special heatsink structure designed into the PCB. This design optimizes the heat transfer from the integrated circuit (IC).

For information on the Quad Flatpack No-Lead (QFN) package and its advantages, refer to Application Report, QFN/SON PCB Attachment, Texas Instruments Literature No. SLUA271. This document is available at www.ti.com.

The exposed thermal pad dimensions for this package are shown in the following illustration.

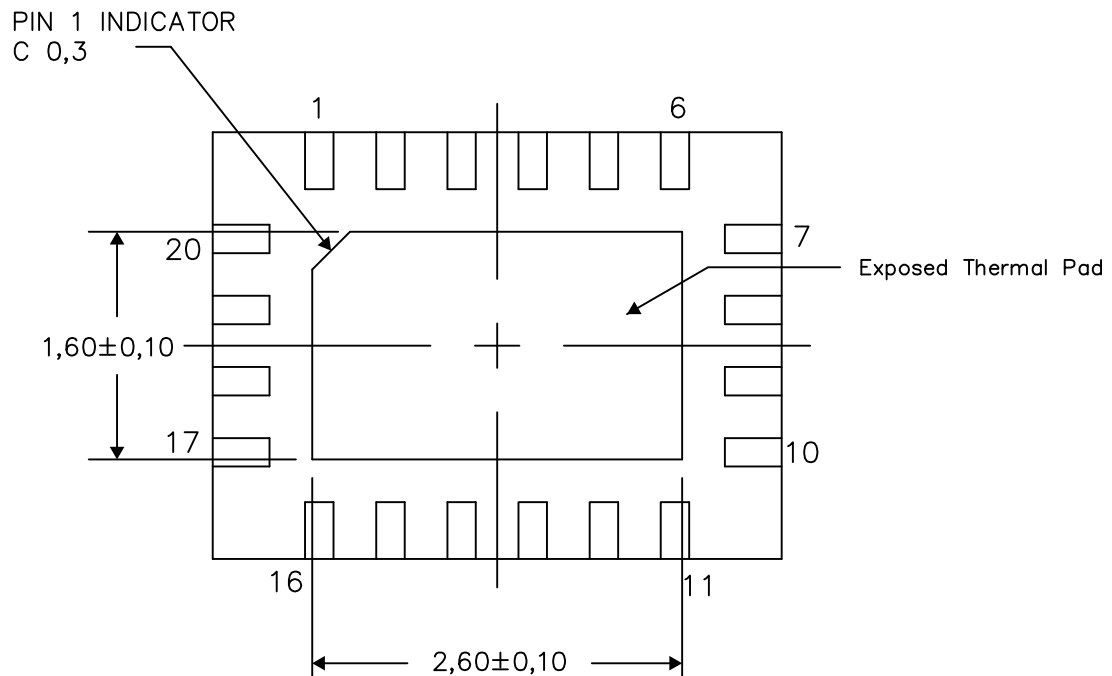

Bottom View

Exposed Thermal Pad Dimensions

4209820-2/F 03/15

NOTE: All linear dimensions are in millimeters

IMPORTANT NOTICE

Texas Instruments Incorporated (TI) reserves the right to make corrections, enhancements, improvements and other changes to its semiconductor products and services per JESD46, latest issue, and to discontinue any product or service per JESD48, latest issue. Buyers should obtain the latest relevant information before placing orders and should verify that such information is current and complete.

TI's published terms of sale for semiconductor products (<http://www.ti.com/sc/docs/stdterms.htm>) apply to the sale of packaged integrated circuit products that TI has qualified and released to market. Additional terms may apply to the use or sale of other types of TI products and services.

Reproduction of significant portions of TI information in TI data sheets is permissible only if reproduction is without alteration and is accompanied by all associated warranties, conditions, limitations, and notices. TI is not responsible or liable for such reproduced documentation. Information of third parties may be subject to additional restrictions. Resale of TI products or services with statements different from or beyond the parameters stated by TI for that product or service voids all express and any implied warranties for the associated TI product or service and is an unfair and deceptive business practice. TI is not responsible or liable for any such statements.

Buyers and others who are developing systems that incorporate TI products (collectively, "Designers") understand and agree that Designers remain responsible for using their independent analysis, evaluation and judgment in designing their applications and that Designers have full and exclusive responsibility to assure the safety of Designers' applications and compliance of their applications (and of all TI products used in or for Designers' applications) with all applicable regulations, laws and other applicable requirements. Designer represents that, with respect to their applications, Designer has all the necessary expertise to create and implement safeguards that (1) anticipate dangerous consequences of failures, (2) monitor failures and their consequences, and (3) lessen the likelihood of failures that might cause harm and take appropriate actions. Designer agrees that prior to using or distributing any applications that include TI products, Designer will thoroughly test such applications and the functionality of such TI products as used in such applications.

TI's provision of technical, application or other design advice, quality characterization, reliability data or other services or information, including, but not limited to, reference designs and materials relating to evaluation modules, (collectively, "TI Resources") are intended to assist designers who are developing applications that incorporate TI products; by downloading, accessing or using TI Resources in any way, Designer (individually or, if Designer is acting on behalf of a company, Designer's company) agrees to use any particular TI Resource solely for this purpose and subject to the terms of this Notice.

TI's provision of TI Resources does not expand or otherwise alter TI's applicable published warranties or warranty disclaimers for TI products, and no additional obligations or liabilities arise from TI providing such TI Resources. TI reserves the right to make corrections, enhancements, improvements and other changes to its TI Resources. TI has not conducted any testing other than that specifically described in the published documentation for a particular TI Resource.

Designer is authorized to use, copy and modify any individual TI Resource only in connection with the development of applications that include the TI product(s) identified in such TI Resource. NO OTHER LICENSE, EXPRESS OR IMPLIED, BY ESTOPPEL OR OTHERWISE TO ANY OTHER TI INTELLECTUAL PROPERTY RIGHT, AND NO LICENSE TO ANY TECHNOLOGY OR INTELLECTUAL PROPERTY RIGHT OF TI OR ANY THIRD PARTY IS GRANTED HEREIN, including but not limited to any patent right, copyright, mask work right, or other intellectual property right relating to any combination, machine, or process in which TI products or services are used. Information regarding or referencing third-party products or services does not constitute a license to use such products or services, or a warranty or endorsement thereof. Use of TI Resources may require a license from a third party under the patents or other intellectual property of the third party, or a license from TI under the patents or other intellectual property of TI.

TI RESOURCES ARE PROVIDED "AS IS" AND WITH ALL FAULTS. TI DISCLAIMS ALL OTHER WARRANTIES OR REPRESENTATIONS, EXPRESS OR IMPLIED, REGARDING RESOURCES OR USE THEREOF, INCLUDING BUT NOT LIMITED TO ACCURACY OR COMPLETENESS, TITLE, ANY EPIDEMIC FAILURE WARRANTY AND ANY IMPLIED WARRANTIES OF MERCHANTABILITY, FITNESS FOR A PARTICULAR PURPOSE, AND NON-INFRINGEMENT OF ANY THIRD PARTY INTELLECTUAL PROPERTY RIGHTS. TI SHALL NOT BE LIABLE FOR AND SHALL NOT DEFEND OR INDEMNIFY DESIGNER AGAINST ANY CLAIM, INCLUDING BUT NOT LIMITED TO ANY INFRINGEMENT CLAIM THAT RELATES TO OR IS BASED ON ANY COMBINATION OF PRODUCTS EVEN IF DESCRIBED IN TI RESOURCES OR OTHERWISE. IN NO EVENT SHALL TI BE LIABLE FOR ANY ACTUAL, DIRECT, SPECIAL, COLLATERAL, INDIRECT, PUNITIVE, INCIDENTAL, CONSEQUENTIAL OR EXEMPLARY DAMAGES IN CONNECTION WITH OR ARISING OUT OF TI RESOURCES OR USE THEREOF, AND REGARDLESS OF WHETHER TI HAS BEEN ADVISED OF THE POSSIBILITY OF SUCH DAMAGES.

Unless TI has explicitly designated an individual product as meeting the requirements of a particular industry standard (e.g., ISO/TS 16949 and ISO 26262), TI is not responsible for any failure to meet such industry standard requirements.

Where TI specifically promotes products as facilitating functional safety or as compliant with industry functional safety standards, such products are intended to help enable customers to design and create their own applications that meet applicable functional safety standards and requirements. Using products in an application does not by itself establish any safety features in the application. Designers must ensure compliance with safety-related requirements and standards applicable to their applications. Designer may not use any TI products in life-critical medical equipment unless authorized officers of the parties have executed a special contract specifically governing such use. Life-critical medical equipment is medical equipment where failure of such equipment would cause serious bodily injury or death (e.g., life support, pacemakers, defibrillators, heart pumps, neurostimulators, and implantables). Such equipment includes, without limitation, all medical devices identified by the U.S. Food and Drug Administration as Class III devices and equivalent classifications outside the U.S.

TI may expressly designate certain products as completing a particular qualification (e.g., Q100, Military Grade, or Enhanced Product). Designers agree that it has the necessary expertise to select the product with the appropriate qualification designation for their applications and that proper product selection is at Designers' own risk. Designers are solely responsible for compliance with all legal and regulatory requirements in connection with such selection.

Designer will fully indemnify TI and its representatives against any damages, costs, losses, and/or liabilities arising out of Designer's non-compliance with the terms and provisions of this Notice.