

# LM4951A Boomer® Audio Power Amplifier Series **Wide Voltage Range 1.8 Watt Audio Amplifier** **With Short Circuit Protection**

Check for Samples: [LM4951A](#)

## FEATURES

- **Pop & Click Circuitry Eliminates Noise During Turn-On and Turn-Off Transitions**
- **Wide Supply Voltage Range: 2.7V to 9V**
- **Low Current, Active-Low Shutdown Mode**
- **Low Quiescent Current**
- **Thermal Shutdown Protection**
- **Short Circuit Protection**
- **Unity-Gain Stable**
- **External Gain Configuration Capability**

## APPLICATIONS

- **Portable Devices**
- **Cell Phones**
- **Laptop Computers**
- **Computer Speaker Systems**
- **MP3 Player Speakers**

## KEY SPECIFICATIONS

- **Wide Voltage Range 2.7V to 9V**
- **Quiescent Power Supply Current ( $V_{DD} = 7.5V$ ) 2.5mA (typ)**
- **Power Output BTL at 7.5V, 1% THD 1.8 W (typ)**
- **Shutdown Current 0.01 $\mu$ A (typ)**
- **Fast Turn on Time 25ms (typ)**

## DESCRIPTION

The LM4951A is an audio power amplifier designed for applications with supply voltages ranging from 2.7V up to 9V. The LM4951A is capable of delivering 1.8W continuous average power with less than 1% THD+N into a bridge connected 8 $\Omega$  load when operating from a 7.5VDC power supply.

Boomer™ audio power amplifiers were designed specifically to provide high quality output power with a minimal amount of external components. The LM4951A does not require bootstrap capacitors, or snubber circuits.

The LM4951A features a low-power consumption active-low shutdown mode. Additionally, the LM4951A features an internal thermal shutdown protection mechanism and short circuit protection.

The LM4951A contains advanced pop & click circuitry that eliminates noises which would otherwise occur during turn-on and turn-off transitions.

The LM4951A is unity-gain stable and can be configured by external gain-setting resistors.



Please be aware that an important notice concerning availability, standard warranty, and use in critical applications of Texas Instruments semiconductor products and disclaimers thereto appears at the end of this data sheet.

Boomer is a trademark of Texas Instruments.

All other trademarks are the property of their respective owners.

Typical Application

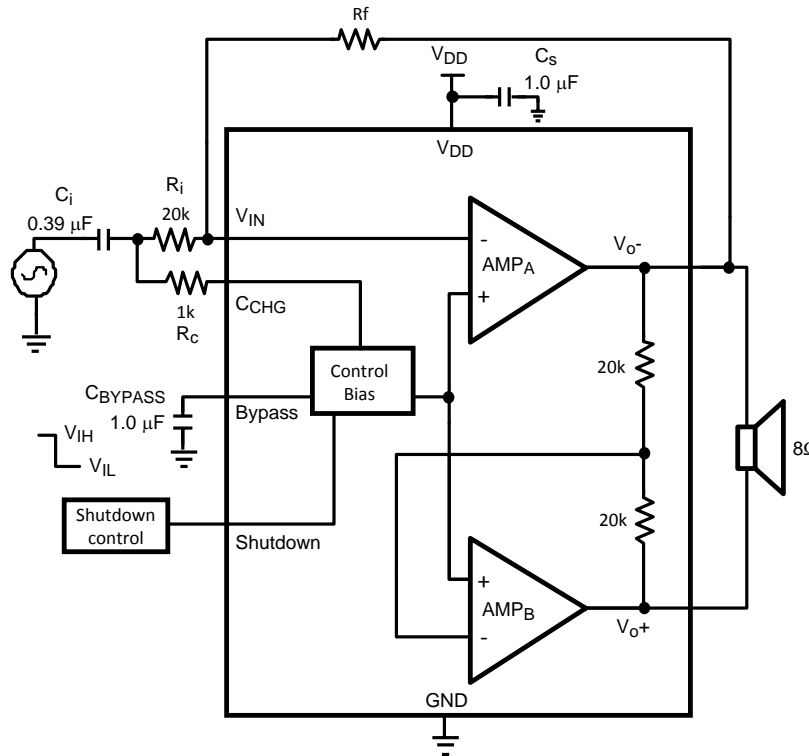

Figure 1. Typical Bridge-Tied-Load (BTL) Audio Amplifier Application Circuit

Connection Diagram

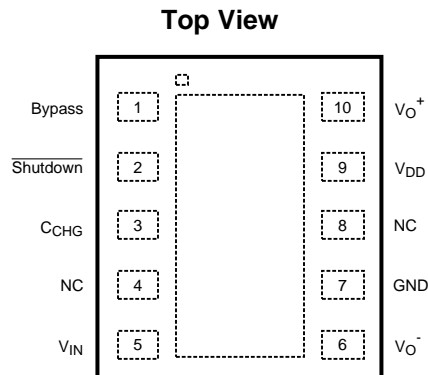

Figure 2. WSON Package  
See Package Number DPR0010A

Pin Name and Function

Pin Number	Name	Function	Type
1	Bypass	½ supply reference voltage bypass output. See sections <a href="#">POWER SUPPLY BYPASSING</a> and <a href="#">SELECTING EXTERNAL COMPONENTS</a> for more information.	Analog Output
2	Shutdown	Shutdown control active low signal. A logic low voltage will put the LM4951A into Shutdown mode.	Digital Input

### Pin Name and Function (continued)

Pin Number	Name	Function	Type
3	C <sub>CHG</sub>	Input capacitor charge to decrease turn on time. See section <a href="#">Selecting Value A For R<sub>C</sub></a> for more information.	Analog Output
4	NC	No connection to die. Pin can be connected to any potential.	No Connect
5	V <sub>IN</sub>	Single-ended signal input pin.	Analog Input
6	V <sub>O-</sub>	Inverting output of amplifier.	Analog Output
7	GND	Ground connection.	Ground
8	NC	No connection to die. Pin can be connected to any potential.	No Connect
9	V <sub>DD</sub>	Power supply.	Power
10	V <sub>O+</sub>	Non-Inverting output of amplifier.	Analog Output
Exposed DAP	NC	No connect. Pin must be electrically isolated (floating) or connected to GND.	No Connect



These devices have limited built-in ESD protection. The leads should be shorted together or the device placed in conductive foam during storage or handling to prevent electrostatic damage to the MOS gates.

### Absolute Maximum Ratings<sup>(1)(2)</sup>

Supply Voltage	9.5V
Storage Temperature	-65°C to +150°C
Input Voltage	-0.3V to V <sub>DD</sub> + 0.3V
Power Dissipation <sup>(3)</sup>	Internally limited
ESD Rating <sup>(4)</sup>	2000V
ESD Rating <sup>(5)</sup>	200V
Junction Temperature (T <sub>JMAX</sub> )	150°C
Thermal Resistance	θ <sub>JA</sub> (WSON) <sup>(3)</sup> 73°C/W
Soldering Information	AN-1187 (Literature Number <a href="#">SNOA401</a> )

- (1) “*Absolute Maximum Ratings*” indicate limits beyond which damage to the device may occur, including inoperability and degradation of device reliability and/or performance. Functional operation of the device and/or non-degradation at the s or other conditions beyond those indicated in the *Recommended Operating Conditions* is not implied. The *Recommended Operating Conditions* indicate conditions at which the device is functional and the device should not be operated beyond such conditions. All voltages are measured with respect to the ground pin, unless otherwise specified.
- (2) The *Electrical Characteristics* tables list ensured specifications under the listed *Recommended Operating Conditions* except as otherwise modified or specified by the *Electrical Characteristics Conditions* and/or Notes. Typical specifications are estimations only and are not ensured.
- (3) The maximum power dissipation must be derated at elevated temperatures and is dictated by T<sub>JMAX</sub>, θ<sub>JA</sub>, and the ambient temperature, T<sub>A</sub>. The maximum allowable power dissipation is P<sub>DMAX</sub> = (T<sub>JMAX</sub> - T<sub>A</sub>) / θ<sub>JA</sub> or the number given in *Absolute Maximum Ratings*, whichever is lower. For the LM4951A typical application (shown in [Figure 1](#)) with V<sub>DD</sub> = 7.5V, R<sub>L</sub> = 8Ω mono-BTL operation the max power dissipation is 1.42W. θ<sub>JA</sub> = 73°C/W.
- (4) Human body model, applicable std. JESD22-A114C.
- (5) Machine model, applicable std. JESD22-A115-A.

### Operating Ratings<sup>(1)(2)</sup>

Temperature Range T <sub>MIN</sub> ≤ T <sub>A</sub> ≤ T <sub>MAX</sub>	-40°C ≤ T <sub>A</sub> ≤ +85°C
Supply Voltage	2.7V ≤ V <sub>DD</sub> ≤ 9V

- (1) “*Absolute Maximum Ratings*” indicate limits beyond which damage to the device may occur, including inoperability and degradation of device reliability and/or performance. Functional operation of the device and/or non-degradation at the s or other conditions beyond those indicated in the *Recommended Operating Conditions* is not implied. The *Recommended Operating Conditions* indicate conditions at which the device is functional and the device should not be operated beyond such conditions. All voltages are measured with respect to the ground pin, unless otherwise specified.
- (2) The *Electrical Characteristics* tables list ensured specifications under the listed *Recommended Operating Conditions* except as otherwise modified or specified by the *Electrical Characteristics Conditions* and/or Notes. Typical specifications are estimations only and are not ensured.

## Electrical Characteristics $V_{DD} = 7.5V^{(1)(2)}$

The following specifications apply for  $V_{DD} = 7.5V$ ,  $A_{V-BTL} = 6dB$ ,  $R_L = 8\Omega$  unless otherwise specified. Limits apply for  $T_A = 25^\circ C$ .

Parameter		Test Conditions	LM4951A		Units (Limits)
			Typ <sup>(3)</sup>	Limit <sup>(4)</sup>	
$I_{DD}$	Quiescent Power Supply Current	$V_{IN} = 0V$ , $I_O = 0A$ , $R_L = 8\Omega$ BTL	2.5	4.5	mA (max)
$I_{SD}$	Shutdown Current	$V_{SD} = GND^{(5)}$	0.01	5	$\mu A$ (max)
$V_{OS}$	Output Offset Voltage		5	30	mV (max)
$V_{SDIH}$	Shutdown Voltage Input High			1.2	V (min)
$V_{SDIL}$	Shutdown Voltage Input Low			0.4	V (max)
$R_{PULLDOWN}$	Pull-down Resistor on SD pin		75	45	k $\Omega$ (min)
$T_{WU}$	Wake-up Time	$C_B = 1.0\mu F$	25	35	ms (max)
$T_{SD}$	Shutdown time	$C_B = 1.0\mu F$		10	ms (max)
TSD	Thermal Shutdown Temperature		170	150 190	$^\circ C$ (min) $^\circ C$ (max)
$P_O$	Output Power	THD = 1% (max); $f = 1kHz$ $R_L = 8\Omega$ Mono BTL	1.8	1.5	W (min)
THD+N	Total Harmonic Distortion + Noise	$P_O = 600mW_{RMS}$ ; $f = 1kHz$ $A_{V-BTL} = 6dB$	0.07	0.5	% (max)
		$P_O = 600mW_{RMS}$ ; $f = 1kHz$ $A_{V-BTL} = 26dB$	0.35		%
$\epsilon_{OS}$	Output Noise	A-Weighted Filter, $R_i = R_f = 20k\Omega$ Input Referred <sup>(6)</sup>	10		$\mu V$
PSRR	Power Supply Rejection Ratio	$V_{RIPPLE} = 200mV_{p-p}$ , $f = 217Hz$ , $C_B = 1.0\mu F$ , Input Referred	66	56	dB (min)

- (1) "Absolute Maximum Ratings" indicate limits beyond which damage to the device may occur, including inoperability and degradation of device reliability and/or performance. Functional operation of the device and/or non-degradation at the s or other conditions beyond those indicated in the *Recommended Operating Conditions* is not implied. The *Recommended Operating Conditions* indicate conditions at which the device is functional and the device should not be operated beyond such conditions. All voltages are measured with respect to the ground pin, unless otherwise specified.
- (2) The *Electrical Characteristics* tables list ensured specifications under the listed *Recommended Operating Conditions* except as otherwise modified or specified by the *Electrical Characteristics Conditions* and/or Notes. Typical specifications are estimations only and are not ensured.
- (3) Typical values represent most likely parametric norms at  $T_A = +25^\circ C$ , and at the *Recommended Operation Conditions* at the time of product characterization and are not specified.
- (4) Datasheet min/max specification limits are ensured by test or statistical analysis.
- (5) Shutdown current is measured in a normal room environment. The Shutdown pin should be driven as close as possible to GND for minimum shutdown current.
- (6) Noise measurements are dependent on the absolute values of the closed loop gain setting resistors (input and feedback resistors).

**Electrical Characteristics  $V_{DD} = 3.3V^{(1)(2)}$** 

The following specifications apply for  $V_{DD} = 3.3V$ ,  $A_{V-BTL} = 6dB$ ,  $R_L = 8\Omega$  unless otherwise specified. Limits apply for  $T_A = 25^\circ C$ .

Parameter		Test Conditions	LM4951A		Units (Limits)
			Typ <sup>(3)</sup>	Limit <sup>(4)</sup>	
$I_{DD}$	Quiescent Power Supply Current	$V_{IN} = 0V$ , $I_O = 0A$ , $R_L = 8\Omega$ BTL	2.5	4.5	mA (max)
$I_{SD}$	Shutdown Current	$V_{SHUTDOWN} = GND^{(5)}$	0.01	2	$\mu A$ (max)
$V_{OS}$	Output Offset Voltage		3	30	mV (max)
$V_{SDIH}$	Shutdown Voltage Input High			1.2	V (min)
$V_{SDIL}$	Shutdown Voltage Input Low			0.4	V (max)
$T_{WU}$	Wake-up Time	$C_B = 1.0\mu F$	25		ms
$T_{SD}$	Shutdown time	$C_B = 1.0\mu F$		10	ms (max)
$P_O$	Output Power	THD = 1% (max); $f = 1kHz$ $R_L = 8\Omega$ Mono BTL	280	230	mW (min)
THD+N	Total Harmonic Distortion + Noise	$P_O = 100mW_{RMS}$ ; $f = 1kHz$ $A_{V-BTL} = 6dB$	0.07	0.5	% (max)
		$P_O = 100mW_{RMS}$ ; $f = 1kHz$ $A_{V-BTL} = 26dB$	0.35		%
$\epsilon_{OS}$	Output Noise	A-Weighted Filter, $R_i = R_f = 20k\Omega$ Input Referred, <sup>(6)</sup>	10		$\mu V$
PSRR	Power Supply Rejection Ratio	$V_{RIPPLE} = 200mV_{p-p}$ , $f = 217Hz$ , $C_B = 1\mu F$ , Input Referred	71	61	dB (min)

- (1) "Absolute Maximum Ratings" indicate limits beyond which damage to the device may occur, including inoperability and degradation of device reliability and/or performance. Functional operation of the device and/or non-degradation at the s or other conditions beyond those indicated in the *Recommended Operating Conditions* is not implied. The *Recommended Operating Conditions* indicate conditions at which the device is functional and the device should not be operated beyond such conditions. All voltages are measured with respect to the ground pin, unless otherwise specified.
- (2) The *Electrical Characteristics* tables list ensured specifications under the listed *Recommended Operating Conditions* except as otherwise modified or specified by the *Electrical Characteristics Conditions* and/or Notes. Typical specifications are estimations only and are not ensured.
- (3) Typical values represent most likely parametric norms at  $T_A = +25^\circ C$ , and at the *Recommended Operation Conditions* at the time of product characterization and are not specified.
- (4) Datasheet min/max specification limits are ensured by test or statistical analysis.
- (5) Shutdown current is measured in a normal room environment. The Shutdown pin should be driven as close as possible to GND for minimum shutdown current.
- (6) Noise measurements are dependent on the absolute values of the closed loop gain setting resistors (input and feedback resistors).

### Typical Performance Characteristics

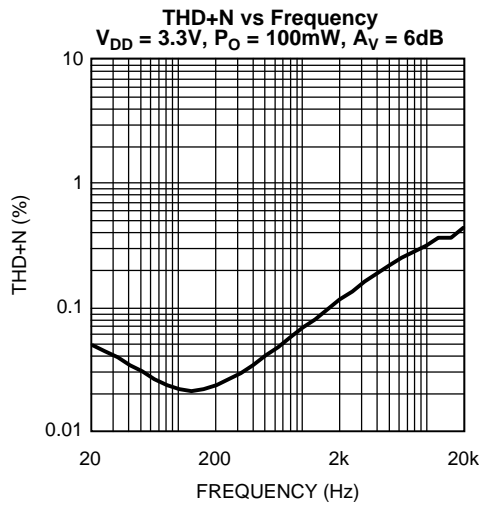

Figure 3.

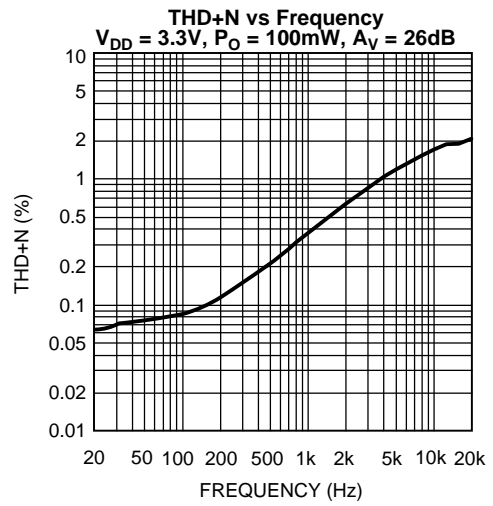

Figure 4.

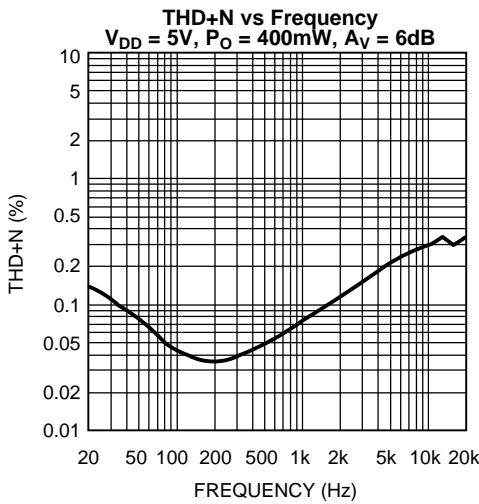

Figure 5.

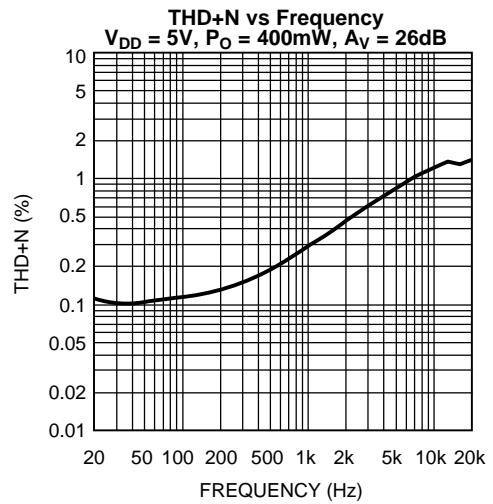

Figure 6.

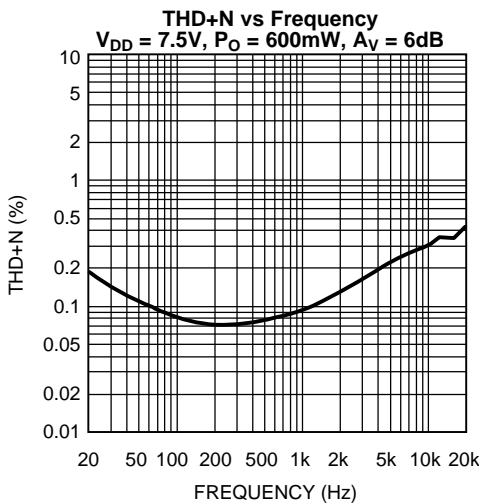

Figure 7.

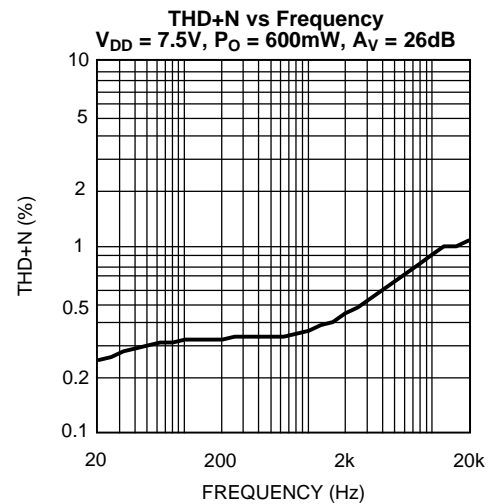

Figure 8.

Typical Performance Characteristics (continued)

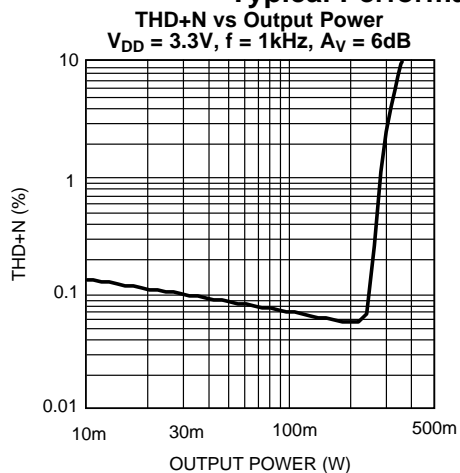

Figure 9.

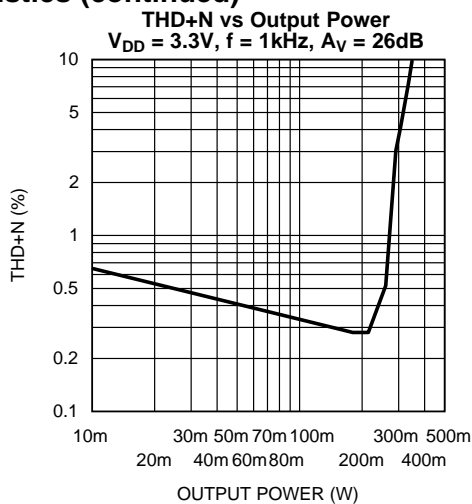

Figure 10.

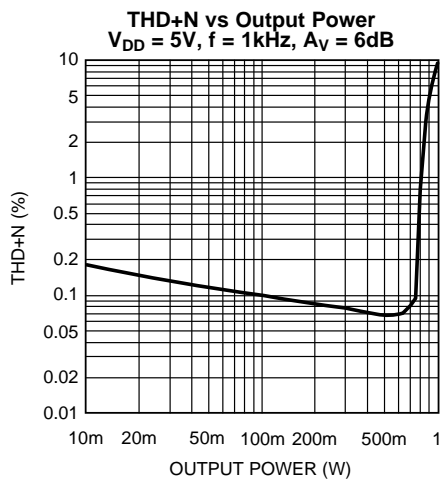

Figure 11.

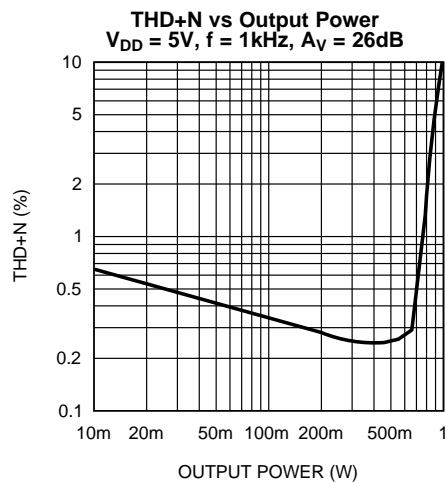

Figure 12.

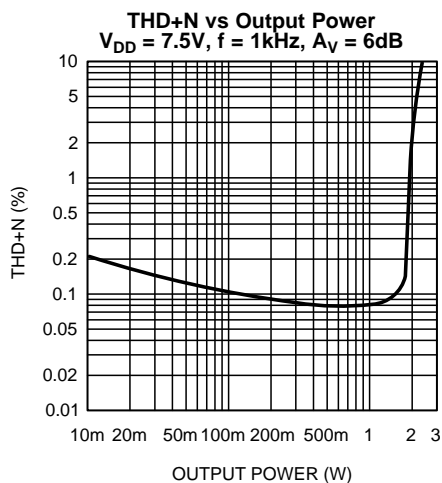

Figure 13.

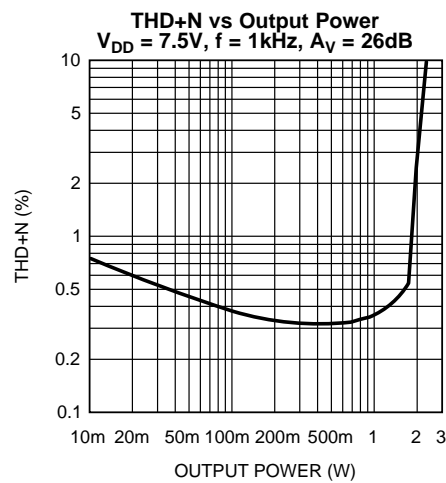

Figure 14.

**Typical Performance Characteristics (continued)**

**Power Supply Rejection vs Frequency**  
 $V_{DD} = 3.3V$ ,  $A_V = 6dB$ ,  $V_{RIPPLE} = 200mV_{P-P}$   
 Input Terminated into  $10\Omega$

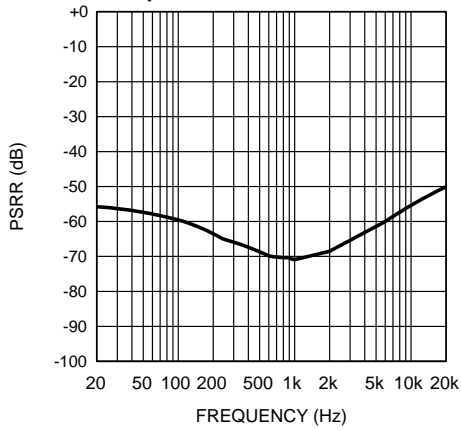

Figure 15.

**Power Supply Rejection vs Frequency**  
 $V_{DD} = 3.3V$ ,  $A_V = 26dB$ ,  $V_{RIPPLE} = 200mV_{P-P}$   
 Input Terminated into  $10\Omega$

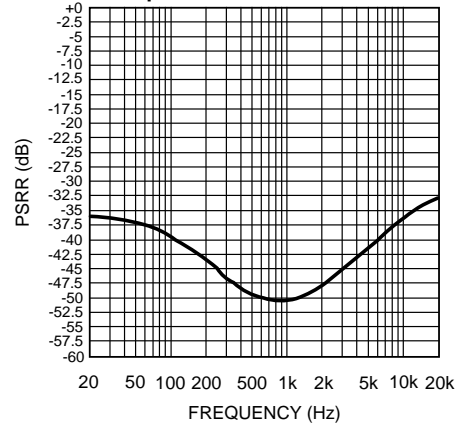

Figure 16.

**Power Supply Rejection vs Frequency**  
 $V_{DD} = 5V$ ,  $A_V = 6dB$ ,  $V_{RIPPLE} = 200mV_{P-P}$   
 Input Terminated into  $10\Omega$

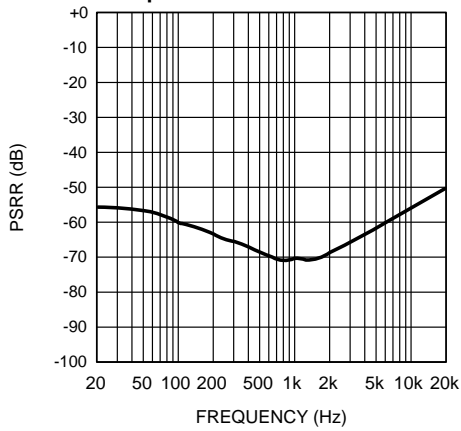

Figure 17.

**Power Supply Rejection vs Frequency**  
 $V_{DD} = 5V$ ,  $A_V = 26dB$ ,  $V_{RIPPLE} = 200mV_{P-P}$   
 Input Terminated into  $10\Omega$

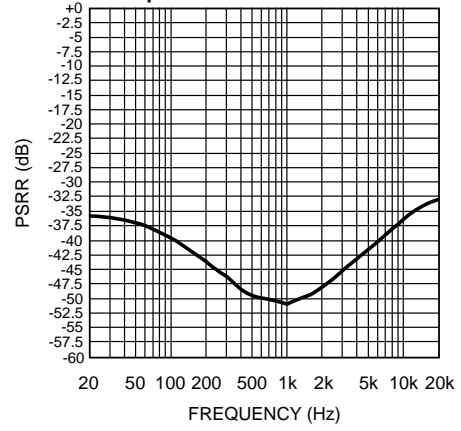

Figure 18.

**Power Supply Rejection vs Frequency**  
 $V_{DD} = 7.5V$ ,  $A_V = 6dB$ ,  $V_{RIPPLE} = 200mV_{P-P}$   
 Input Terminated into  $10\Omega$

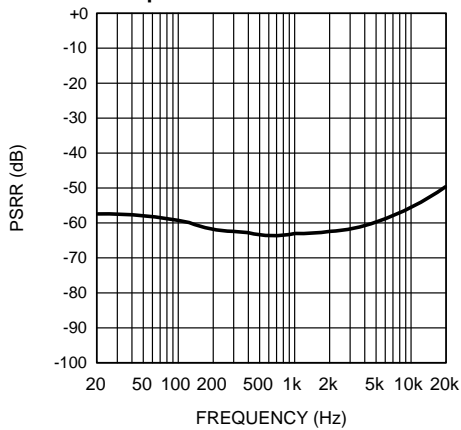

Figure 19.

**Power Supply Rejection vs Frequency**  
 $V_{DD} = 7.5V$ ,  $A_V = 26dB$ ,  $V_{RIPPLE} = 200mV_{P-P}$   
 Input Terminated into  $10\Omega$

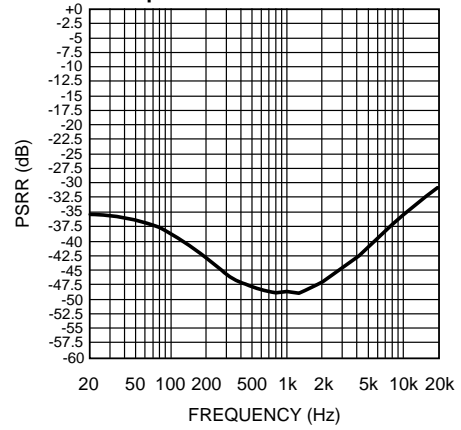

Figure 20.



Typical Performance Characteristics (continued)

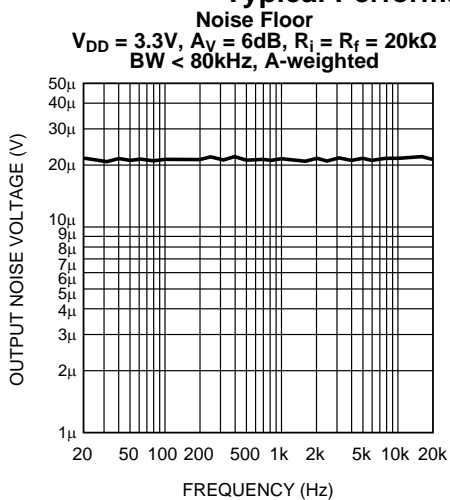

Figure 21.

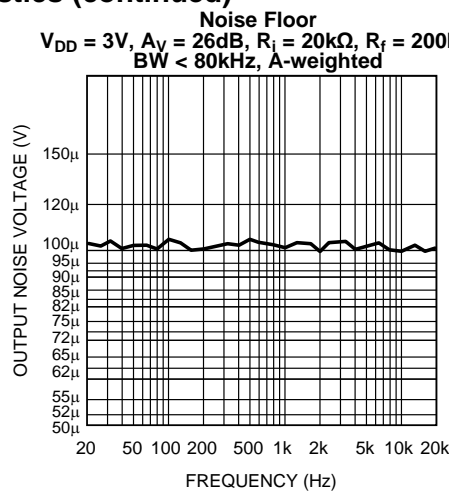

Figure 22.

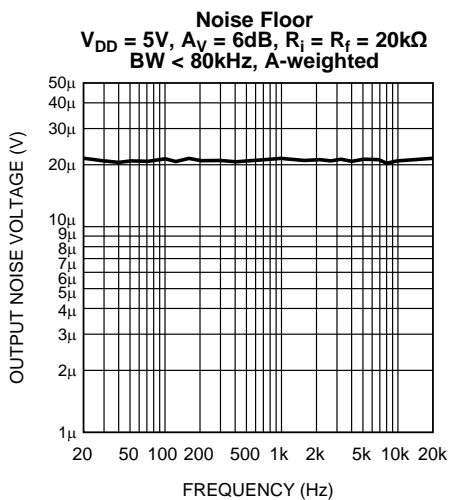

Figure 23.

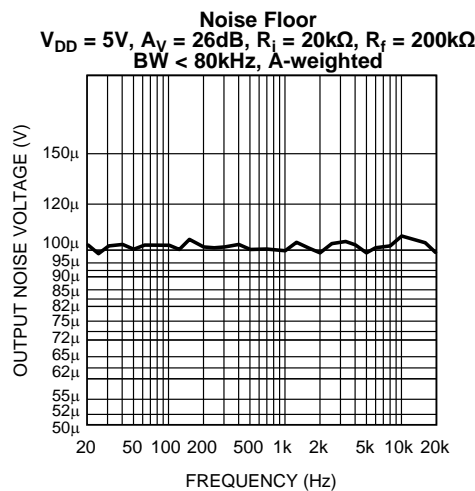

Figure 24.

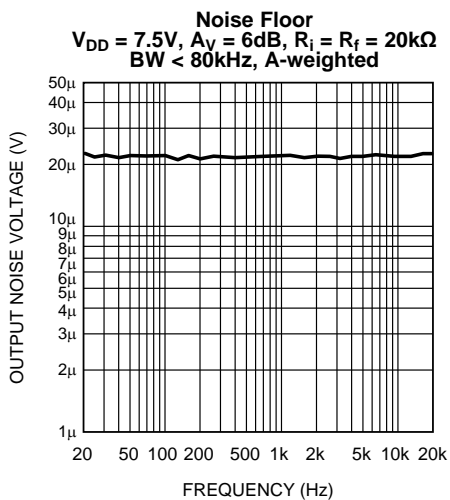

Figure 25.

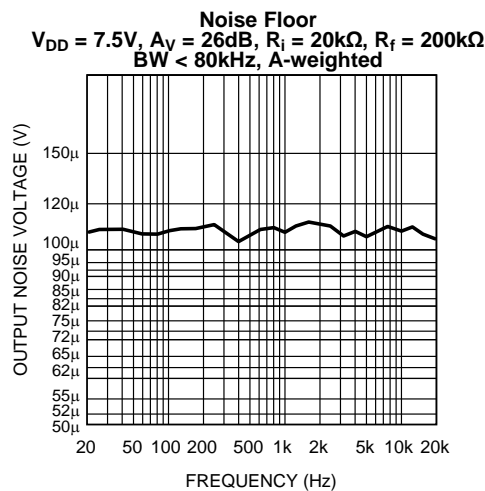

Figure 26.

**Typical Performance Characteristics (continued)**

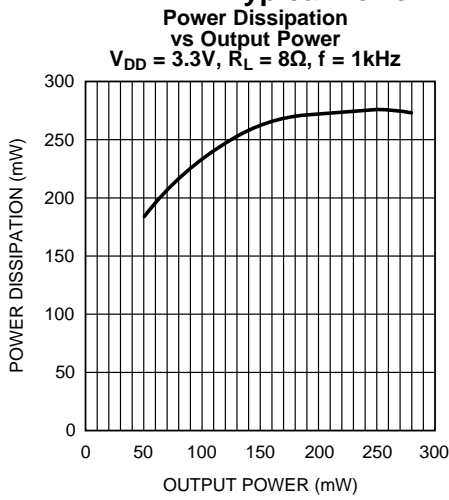

Figure 27.

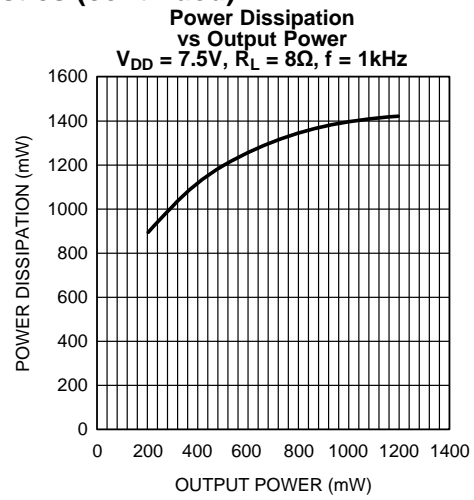

Figure 28.

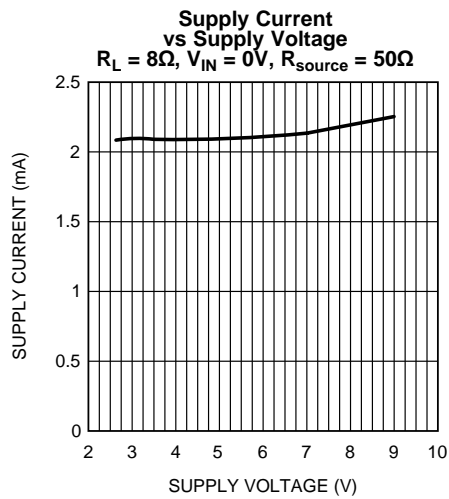

Figure 29.

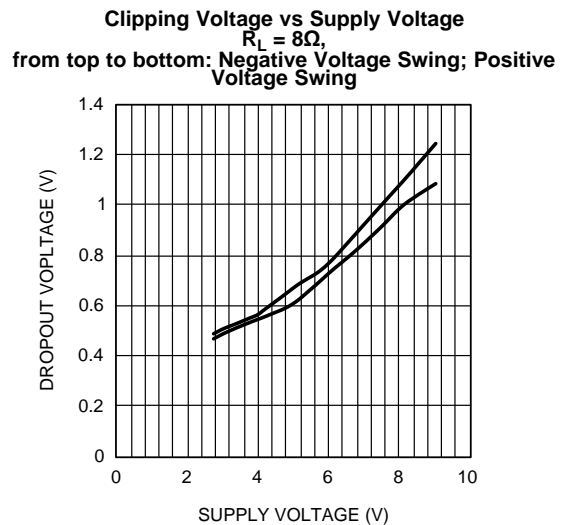

Figure 30.

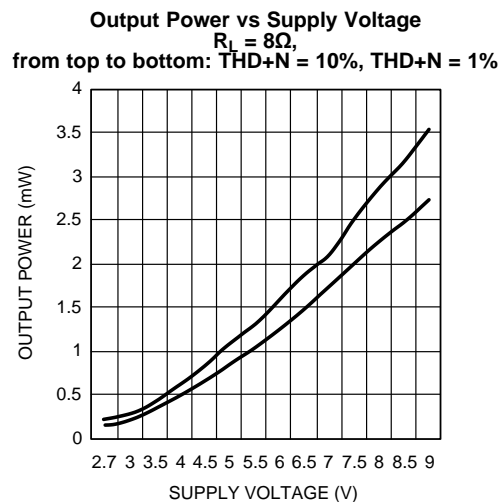

Figure 31.

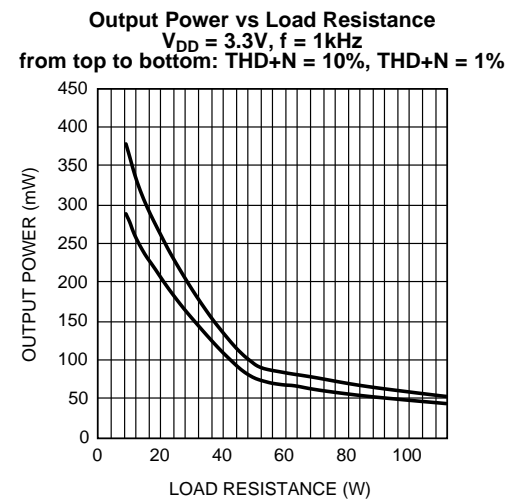
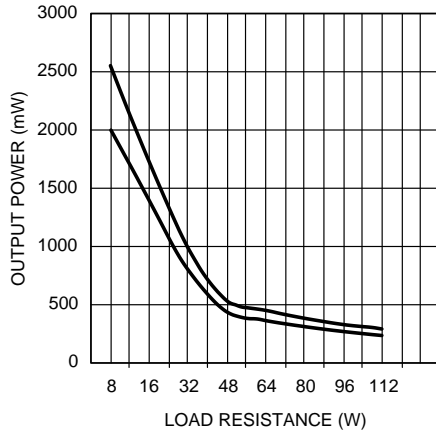

Figure 32.

**Typical Performance Characteristics (continued)**

**Output Power vs Load Resistance**  
 $V_{DD} = 7.5V$ ,  $f = 1kHz$   
 from top to bottom: THD+N = 10%, THD+N = 1%



**Figure 33.**

**Frequency Response vs Input Capacitor Size**  
 $R_L = 8\Omega$   
 from top to bottom:  $C_1 = 1.0\mu F$ ,  $C_1 = 0.39\mu F$ ,  $C_1 = 0.039\mu F$

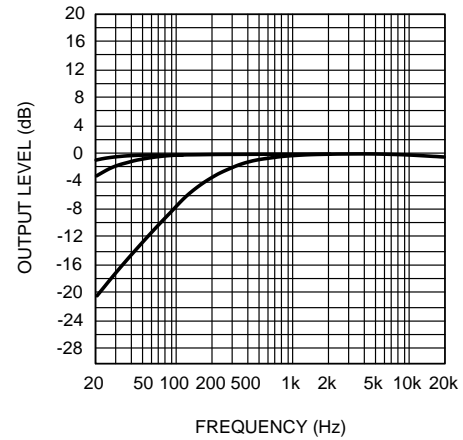

**Figure 34.**

## APPLICATION INFORMATION

### BRIDGE CONFIGURATION EXPLANATION

As shown in [Figure 1](#), the LM4951A consists of two operational amplifiers that drive a speaker connected between their outputs. The value of input and feedback resistors determine the gain of each amplifier. External resistors  $R_i$  and  $R_f$  set the closed-loop gain of AMP<sub>A</sub>, whereas two 20kΩ internal resistors set AMP<sub>B</sub>'s gain to -1. [Figure 1](#) shows that AMP<sub>A</sub>'s output serves as AMP<sub>B</sub>'s input. This results in both amplifiers producing signals identical in magnitude, but 180° out of phase. Taking advantage of this phase difference, a load is placed between AMP<sub>A</sub> and AMP<sub>B</sub> and driven differentially (commonly referred to as "bridge-tied load"). This results in a differential, or BTL, gain of:

$$A_{VD} = 2(R_f / R_i) \quad (V/V) \quad (1)$$

Bridge mode amplifiers are different from single-ended amplifiers that drive loads connected between a single amplifier's output and ground. For a given supply voltage, bridge mode has an advantage over the single-ended configuration: its differential output doubles the voltage swing across the load. Theoretically, this produces four times the output power when compared to a single-ended amplifier under the same conditions. This increase in attainable output power assumes that the amplifier is not current limited and that the output signal is not clipped. Under rare conditions, with unique combinations of high power supply voltage and high closed loop gain settings, the LM4951A may exhibit low frequency oscillations.

Another advantage of the differential bridge output is no net DC voltage across the load. This is accomplished by biasing AMP1's and AMP2's outputs at half-supply. This eliminates the coupling capacitor that single supply, single-ended amplifiers require. Eliminating an output coupling capacitor in a typical single-ended configuration forces a single-supply amplifier's half-supply bias voltage across the load. This increases internal IC power dissipation and may permanently damage loads such as speakers.

### POWER DISSIPATION

The LM4951A's dissipation when driving a BTL load is given by [Equation 2](#). For a 7.5V supply and a single 8Ω BTL load, the dissipation is 1.42W.

$$P_{DMAX-MONOBTL} = 4(V_{DD})^2 / 2\pi^2 R_L \quad (W) \quad (2)$$

The maximum power dissipation point given by [Equation 2](#) must not exceed the power dissipation given by [Equation 3](#):

$$P_{DMAX} = (T_{JMAX} - T_A) / \theta_{JA} \quad (3)$$

The LM4951A's  $T_{JMAX} = 150^\circ\text{C}$ . In the SD package, the LM4951A's  $\theta_{JA}$  is  $73^\circ\text{C/W}$  when the metal tab is soldered to a copper plane of at least  $1\text{in}^2$ . This plane can be split between the top and bottom layers of a two-sided PCB. Connect the two layers together under the tab with an array of vias. At any given ambient temperature  $T_A$ , use [Equation 3](#) to find the maximum internal power dissipation supported by the IC packaging. Rearranging [Equation 3](#) and substituting  $P_{DMAX}$  for  $P_{DMAX}'$  results in [Equation 4](#). This equation gives the maximum ambient temperature that still allows maximum stereo power dissipation without violating the LM4951A's maximum junction temperature.

$$T_A = T_{JMAX} - P_{DMAX-MONOBTL} \theta_{JA} \quad (^\circ\text{C}) \quad (4)$$

For a typical application with a 7.5V power supply and a BTL 8Ω load, the maximum ambient temperature that allows maximum stereo power dissipation without exceeding the maximum junction temperature is  $46^\circ\text{C}$  for the SD package.

$$T_{JMAX} = P_{DMAX-MONOBTL} \theta_{JA} + T_A \quad (^\circ\text{C}) \quad (5)$$

[Equation 5](#) gives the maximum junction temperature  $T_{JMAX}$ . If the result violates the LM4951A's maximum junction temperature of  $150^\circ\text{C}$ , reduce the maximum junction temperature by reducing the power supply voltage or increasing the load resistance. Further allowance should be made for increased ambient temperatures.

The above examples assume that a device is operating around the maximum power dissipation point. Since internal power dissipation is a function of output power, higher ambient temperatures are allowed as output power or duty cycle decreases.

If the result of [Equation 2](#) is greater than that of [Equation 3](#), then decrease the supply voltage, increase the load impedance, or reduce the ambient temperature. Further, ensure that speakers rated at a nominal 8Ω do not fall below 6Ω. If these measures are insufficient, a heat sink can be added to reduce  $\theta_{JA}$ . The heat sink can be created using additional copper area around the package, with connections to the ground pins, supply pin and amplifier output pins. Refer to the [Typical Performance Characteristics](#) curves for power dissipation information at lower output power levels.

## POWER SUPPLY BYPASSING

As with any power amplifier, proper supply bypassing is critical for low noise performance and high power supply rejection. Applications that employ a voltage regulator typically use a 10μF in parallel with a 0.1μF filter capacitors to stabilize the regulator's output, reduce noise on the supply line, and improve the supply's transient response. However, their presence does not eliminate the need for a local 1.0μF tantalum bypass capacitance connected between the LM4951A's supply pins and ground. Do not substitute a ceramic capacitor for the tantalum. Doing so may cause oscillation. Keep the length of leads and traces that connect capacitors between the LM4951A's power supply pin and ground as short as possible. Connecting a larger capacitor,  $C_{BYPASS}$ , between the BYPASS pin and ground improves the internal bias voltage's stability and improves the amplifier's PSRR. The PSRR improvements increase as the bypass pin capacitor value increases. Too large, however, increases turn-on time and can compromise the amplifier's click and pop performance. The selection of bypass capacitor values, especially  $C_{BYPASS}$ , depends on desired PSRR requirements, click and pop performance, system cost, and size constraints.

## MICRO-POWER SHUTDOWN

The LM4951A features an active-low micro-power shutdown mode. When active, the LM4951A's micro-power shutdown feature turns off the amplifier's bias circuitry, reducing the supply current. The low 0.01μA typical shutdown current is achieved by applying a voltage to the SHUTDOWN pin that is as near to GND as possible. A voltage that is greater than GND may increase the shutdown current.

## SELECTING EXTERNAL COMPONENTS

### Input Capacitor Value Selection

Two quantities determine the value of the input coupling capacitor: the lowest audio frequency that requires amplification and desired output transient suppression.

As shown in [Figure 1](#), the input resistor ( $R_i$ ) and the input capacitor ( $C_i$ ) create a high-pass filter. The cutoff frequency can be found using [Equation 6](#).

$$f_c = 1/2\pi R_i C_i \quad (\text{Hz}) \quad (6)$$

As an example when using a speaker with a low frequency limit of 50Hz,  $C_i$ , using [Equation 6](#) is 0.159μF with  $R_i$  set to 20kΩ. The values for  $C_i$  and  $R_i$  shown in [Figure 1](#) allow the LM4951A to drive a high efficiency, full range speaker whose response extends down to 20Hz.

### Selecting Value A For $R_C$

The LM4951A is designed for very fast turn on time. The  $C_{CHG}$  pin allows the input capacitor to charge quickly to improve click/pop performance.  $R_C$  protects the  $C_{CHG}$  pin from any over/under voltage conditions caused by excessive input signal or an active input signal when the device is in shutdown. The recommended value for  $R_C$  is 1kΩ. If the input signal is less than  $V_{DD}+0.3V$  and greater than -0.3V, and if the input signal is disabled when in shutdown mode,  $R_C$  may be shorted out.

## OPTIMIZING CLICK AND POP REDUCTION PERFORMANCE

The LM4951A contains circuitry that eliminates turn-on and shutdown transients ("clicks and pops"). For this discussion, turn-on refers to either applying the power supply voltage or when the micro-power shutdown mode is deactivated.

As the  $V_{DD}/2$  voltage present at the BYPASS pin ramps to its final value, the LM4951A's internal amplifiers are configured as unity gain buffers. An internal current source charges the capacitor connected between the BYPASS pin and GND in a controlled manner. Ideally, the input and outputs track the voltage applied to the BYPASS pin.

The gain of the internal amplifiers remains unity until the voltage on the bypass pin reaches  $V_{DD}/2$ . As soon as the voltage on the bypass pin is stable, there is a delay to prevent undesirable output transients (“click and pops”). After this delay, the device becomes fully functional.

## THERMAL SHUTDOWN AND SHORT CIRCUIT PROTECTION

The LM4951A has thermal shutdown and short circuit protection to fully protect the device. The thermal shutdown circuit is activated when the die temperature exceeds a safe temperature. The short circuit protection circuitry senses the output current. When the output current exceeds the threshold under a short condition, a short will be detected and the output deactivated until the short condition is removed. If the output current is lower than the threshold then a short will not be detected and the outputs will not be deactivated. Under such conditions the die temperature will increase and, if the condition persists to raise the die temperature to the thermal shutdown threshold, initiate a thermal shutdown response. Once the die cools the outputs will become active.

## RECOMMENDED PRINTED CIRCUIT BOARD LAYOUT

Figures 2–4 show the recommended two-layer PC board layout that is optimized for the SD10A. This circuit is designed for use with an external 7.5V supply 8Ω (min) speakers.

### Demonstration Board Circuit

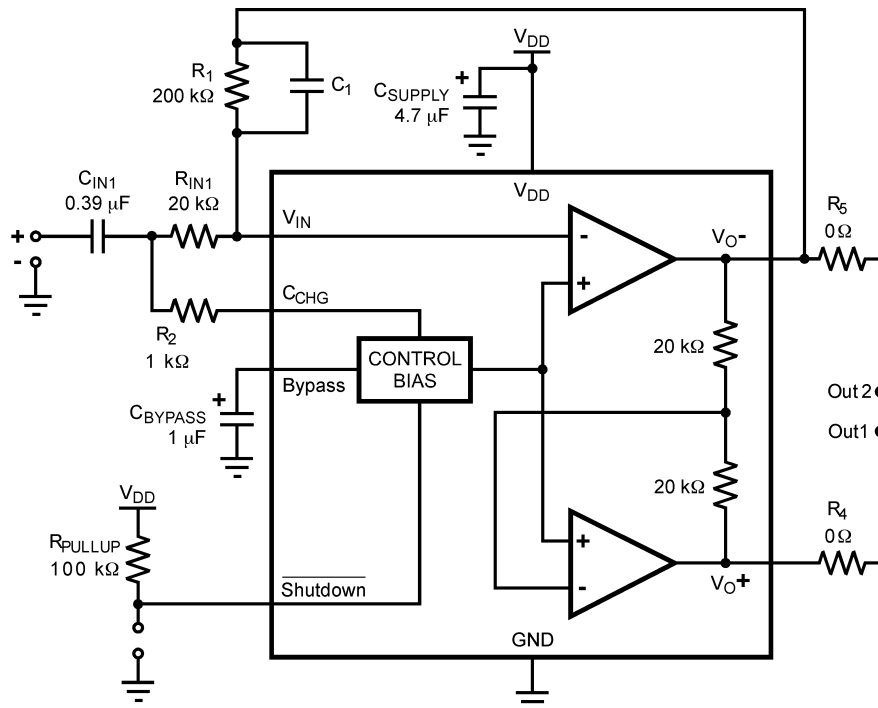

Figure 35. Demo Board Circuit

## Demonstration Board Layout

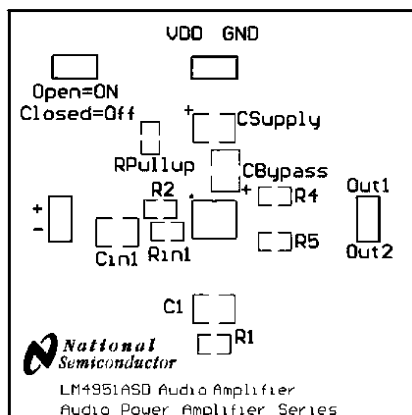

Figure 36. Top Silkscreen

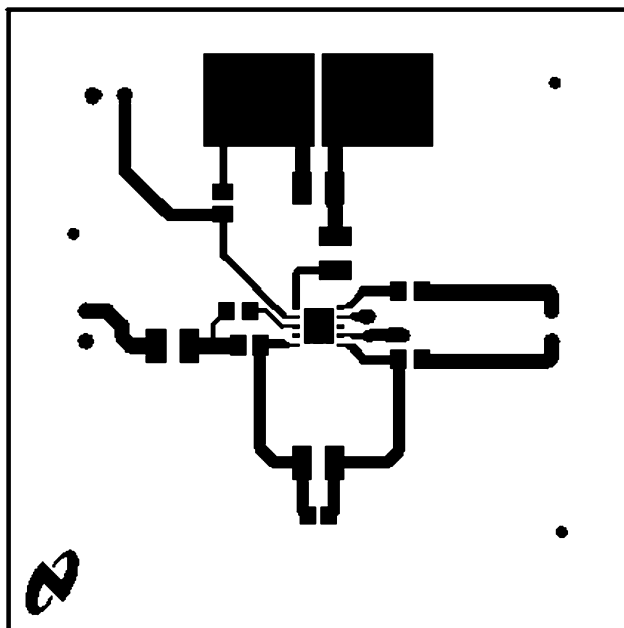

Figure 37. Top Layer

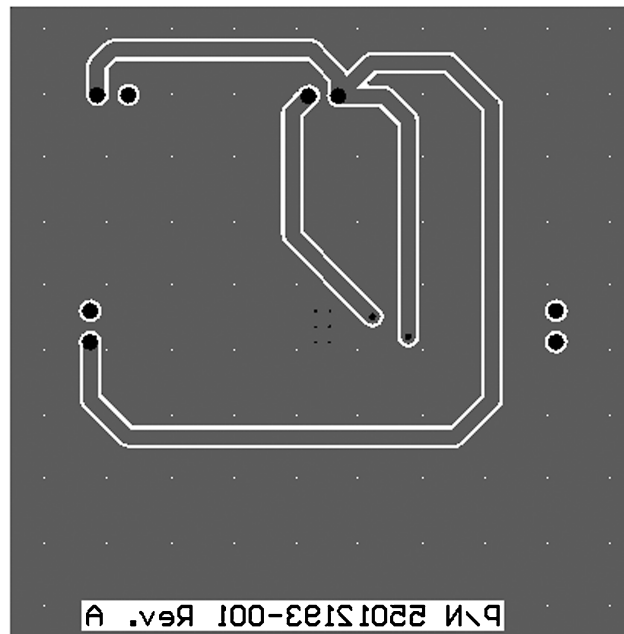

Figure 38. Bottom Layer

## Bill Of Materials

Table 1. Bill Of Materials

Designator	Value	Tolerance	Part Description	Comments
R <sub>IN1</sub>	20kΩ	1%	1/8W, 0805 Resistor	
R <sub>1</sub>	200kΩ	1%	1/8W, 0805 Resistor	
R <sub>PULLUP</sub>	100kΩ	1%	1/8W, 0805 Resistor	
R <sub>2</sub>	1kΩ	1%	1/8W, 0805 Resistor	
R <sub>4</sub> , R <sub>5</sub>	0Ω	1%	1/8W, 0805 Resistor	
C <sub>IN1</sub>	0.39μF	10%	Ceramic Capacitor, 25V, Size 1206	
C <sub>SUPPLY</sub>	4.7μF	10%	16V Tantalum Capacitor, Size A	
C <sub>BYPASS</sub>	1μF	10%	16V Tantalum Capacitor, Size A	
C <sub>1</sub>				Not Used
			0.100" 1x2 header, vertical mount	Input, Output, Vdd/GND Shutdown
U <sub>1</sub>			LM4951A, Mono, 1.8W, Audio Amplifier	DPR0010A package



### REVISION HISTORY

Rev	Date	Description
1.0	08/13/08	Initial release.
1.01	09/05/08	Text edits.

**Changes from Revision B (April 2013) to Revision C**
**Page**

- 
- Changed layout of National Data Sheet to TI format ..... [16](#)
-

**PACKAGING INFORMATION**

Orderable Device	Status (1)	Package Type	Package Drawing	Pins	Package Qty	Eco Plan (2)	Lead/Ball Finish (6)	MSL Peak Temp (3)	Op Temp (°C)	Device Marking (4/5)	Samples
LM4951ASD/NOPB	ACTIVE	WSO	DPR	10	1000	Green (RoHS & no Sb/Br)	CU SN	Level-1-260C-UNLIM	-40 to 85	4951ASD	<a href="#">Samples</a>
LM4951ASDX/NOPB	ACTIVE	WSO	DPR	10	4500	Green (RoHS & no Sb/Br)	CU SN	Level-1-260C-UNLIM	-40 to 85	4951ASD	<a href="#">Samples</a>

(1) The marketing status values are defined as follows:

**ACTIVE:** Product device recommended for new designs.

**LIFEBUY:** TI has announced that the device will be discontinued, and a lifetime-buy period is in effect.

**NRND:** Not recommended for new designs. Device is in production to support existing customers, but TI does not recommend using this part in a new design.

**PREVIEW:** Device has been announced but is not in production. Samples may or may not be available.

**OBSELETE:** TI has discontinued the production of the device.

(2) Eco Plan - The planned eco-friendly classification: Pb-Free (RoHS), Pb-Free (RoHS Exempt), or Green (RoHS & no Sb/Br) - please check <http://www.ti.com/productcontent> for the latest availability information and additional product content details.

**TBD:** The Pb-Free/Green conversion plan has not been defined.

**Pb-Free (RoHS):** TI's terms "Lead-Free" or "Pb-Free" mean semiconductor products that are compatible with the current RoHS requirements for all 6 substances, including the requirement that lead not exceed 0.1% by weight in homogeneous materials. Where designed to be soldered at high temperatures, TI Pb-Free products are suitable for use in specified lead-free processes.

**Pb-Free (RoHS Exempt):** This component has a RoHS exemption for either 1) lead-based flip-chip solder bumps used between the die and package, or 2) lead-based die adhesive used between the die and leadframe. The component is otherwise considered Pb-Free (RoHS compatible) as defined above.

**Green (RoHS & no Sb/Br):** TI defines "Green" to mean Pb-Free (RoHS compatible), and free of Bromine (Br) and Antimony (Sb) based flame retardants (Br or Sb do not exceed 0.1% by weight in homogeneous material)

(3) MSL, Peak Temp. - The Moisture Sensitivity Level rating according to the JEDEC industry standard classifications, and peak solder temperature.

(4) There may be additional marking, which relates to the logo, the lot trace code information, or the environmental category on the device.

(5) Multiple Device Markings will be inside parentheses. Only one Device Marking contained in parentheses and separated by a "~" will appear on a device. If a line is indented then it is a continuation of the previous line and the two combined represent the entire Device Marking for that device.

(6) Lead/Ball Finish - Orderable Devices may have multiple material finish options. Finish options are separated by a vertical ruled line. Lead/Ball Finish values may wrap to two lines if the finish value exceeds the maximum column width.

**Important Information and Disclaimer:** The information provided on this page represents TI's knowledge and belief as of the date that it is provided. TI bases its knowledge and belief on information provided by third parties, and makes no representation or warranty as to the accuracy of such information. Efforts are underway to better integrate information from third parties. TI has taken and continues to take reasonable steps to provide representative and accurate information but may not have conducted destructive testing or chemical analysis on incoming materials and chemicals. TI and TI suppliers consider certain information to be proprietary, and thus CAS numbers and other limited information may not be available for release.

In no event shall TI's liability arising out of such information exceed the total purchase price of the TI part(s) at issue in this document sold by TI to Customer on an annual basis.

## TAPE AND REEL INFORMATION



### QUADRANT ASSIGNMENTS FOR PIN 1 ORIENTATION IN TAPE



\*All dimensions are nominal

Device	Package Type	Package Drawing	Pins	SPQ	Reel Diameter (mm)	Reel Width W1 (mm)	A0 (mm)	B0 (mm)	K0 (mm)	P1 (mm)	W (mm)	Pin1 Quadrant
LM4951ASD/NOPB	WSON	DPR	10	1000	178.0	12.4	4.3	4.3	1.3	8.0	12.0	Q1
LM4951ASDX/NOPB	WSON	DPR	10	4500	330.0	12.4	4.3	4.3	1.3	8.0	12.0	Q1

**TAPE AND REEL BOX DIMENSIONS**



\*All dimensions are nominal

Device	Package Type	Package Drawing	Pins	SPQ	Length (mm)	Width (mm)	Height (mm)
LM4951ASD/NOPB	WSON	DPR	10	1000	210.0	185.0	35.0
LM4951ASDX/NOPB	WSON	DPR	10	4500	367.0	367.0	35.0

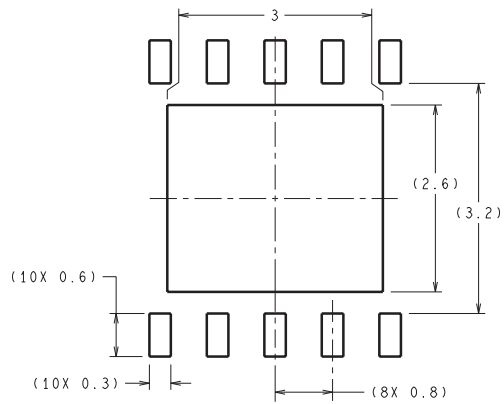
DPR0010A

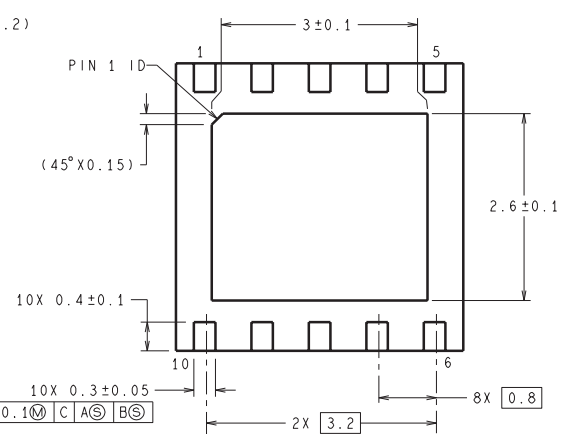
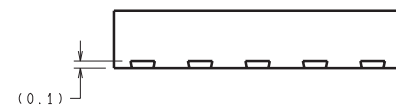
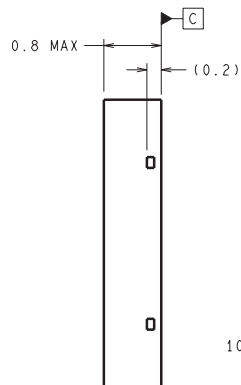
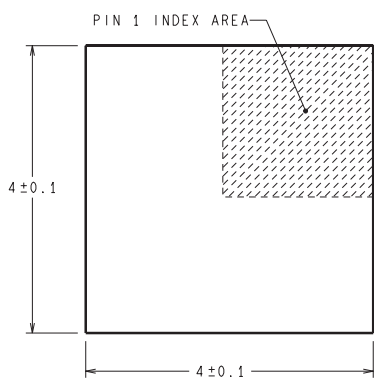

RECOMMENDED LAND PATTERN



DIMENSIONS ARE IN MILLIMETERS

SDC10A (Rev A)

## IMPORTANT NOTICE

Texas Instruments Incorporated and its subsidiaries (TI) reserve the right to make corrections, enhancements, improvements and other changes to its semiconductor products and services per JESD46, latest issue, and to discontinue any product or service per JESD48, latest issue. Buyers should obtain the latest relevant information before placing orders and should verify that such information is current and complete. All semiconductor products (also referred to herein as "components") are sold subject to TI's terms and conditions of sale supplied at the time of order acknowledgment.

TI warrants performance of its components to the specifications applicable at the time of sale, in accordance with the warranty in TI's terms and conditions of sale of semiconductor products. Testing and other quality control techniques are used to the extent TI deems necessary to support this warranty. Except where mandated by applicable law, testing of all parameters of each component is not necessarily performed.

TI assumes no liability for applications assistance or the design of Buyers' products. Buyers are responsible for their products and applications using TI components. To minimize the risks associated with Buyers' products and applications, Buyers should provide adequate design and operating safeguards.

TI does not warrant or represent that any license, either express or implied, is granted under any patent right, copyright, mask work right, or other intellectual property right relating to any combination, machine, or process in which TI components or services are used. Information published by TI regarding third-party products or services does not constitute a license to use such products or services or a warranty or endorsement thereof. Use of such information may require a license from a third party under the patents or other intellectual property of the third party, or a license from TI under the patents or other intellectual property of TI.

Reproduction of significant portions of TI information in TI data books or data sheets is permissible only if reproduction is without alteration and is accompanied by all associated warranties, conditions, limitations, and notices. TI is not responsible or liable for such altered documentation. Information of third parties may be subject to additional restrictions.

Resale of TI components or services with statements different from or beyond the parameters stated by TI for that component or service voids all express and any implied warranties for the associated TI component or service and is an unfair and deceptive business practice. TI is not responsible or liable for any such statements.

Buyer acknowledges and agrees that it is solely responsible for compliance with all legal, regulatory and safety-related requirements concerning its products, and any use of TI components in its applications, notwithstanding any applications-related information or support that may be provided by TI. Buyer represents and agrees that it has all the necessary expertise to create and implement safeguards which anticipate dangerous consequences of failures, monitor failures and their consequences, lessen the likelihood of failures that might cause harm and take appropriate remedial actions. Buyer will fully indemnify TI and its representatives against any damages arising out of the use of any TI components in safety-critical applications.

In some cases, TI components may be promoted specifically to facilitate safety-related applications. With such components, TI's goal is to help enable customers to design and create their own end-product solutions that meet applicable functional safety standards and requirements. Nonetheless, such components are subject to these terms.

No TI components are authorized for use in FDA Class III (or similar life-critical medical equipment) unless authorized officers of the parties have executed a special agreement specifically governing such use.

Only those TI components which TI has specifically designated as military grade or "enhanced plastic" are designed and intended for use in military/aerospace applications or environments. Buyer acknowledges and agrees that any military or aerospace use of TI components which have **not** been so designated is solely at the Buyer's risk, and that Buyer is solely responsible for compliance with all legal and regulatory requirements in connection with such use.

TI has specifically designated certain components as meeting ISO/TS16949 requirements, mainly for automotive use. In any case of use of non-designated products, TI will not be responsible for any failure to meet ISO/TS16949.

### Products

Audio	<a href="http://www.ti.com/audio">www.ti.com/audio</a>
Amplifiers	<a href="http://amplifier.ti.com">amplifier.ti.com</a>
Data Converters	<a href="http://dataconverter.ti.com">dataconverter.ti.com</a>
DLP® Products	<a href="http://www.dlp.com">www.dlp.com</a>
DSP	<a href="http://dsp.ti.com">dsp.ti.com</a>
Clocks and Timers	<a href="http://www.ti.com/clocks">www.ti.com/clocks</a>
Interface	<a href="http://interface.ti.com">interface.ti.com</a>
Logic	<a href="http://logic.ti.com">logic.ti.com</a>
Power Mgmt	<a href="http://power.ti.com">power.ti.com</a>
Microcontrollers	<a href="http://microcontroller.ti.com">microcontroller.ti.com</a>
RFID	<a href="http://www.ti-rfid.com">www.ti-rfid.com</a>
OMAP Applications Processors	<a href="http://www.ti.com/omap">www.ti.com/omap</a>
Wireless Connectivity	<a href="http://www.ti.com/wirelessconnectivity">www.ti.com/wirelessconnectivity</a>

### Applications

Automotive and Transportation	<a href="http://www.ti.com/automotive">www.ti.com/automotive</a>
Communications and Telecom	<a href="http://www.ti.com/communications">www.ti.com/communications</a>
Computers and Peripherals	<a href="http://www.ti.com/computers">www.ti.com/computers</a>
Consumer Electronics	<a href="http://www.ti.com/consumer-apps">www.ti.com/consumer-apps</a>
Energy and Lighting	<a href="http://www.ti.com/energy">www.ti.com/energy</a>
Industrial	<a href="http://www.ti.com/industrial">www.ti.com/industrial</a>
Medical	<a href="http://www.ti.com/medical">www.ti.com/medical</a>
Security	<a href="http://www.ti.com/security">www.ti.com/security</a>
Space, Avionics and Defense	<a href="http://www.ti.com/space-avionics-defense">www.ti.com/space-avionics-defense</a>
Video and Imaging	<a href="http://www.ti.com/video">www.ti.com/video</a>

### TI E2E Community

[e2e.ti.com](http://e2e.ti.com)