

### Features

- 40V/120A,  
 $R_{DS(ON)} = 2.7m\Omega(Typ.)@V_{GS}=10V$
- Super High Dense Cell Design
- Ultra Low On-Resistance
- Fast Switching Speed
- 100% avalanche tested
- Lead Free and Green Devices Available (RoHS Compliant)

### Applications

- DC/DC Converters
- Power Supply

### Pin Description

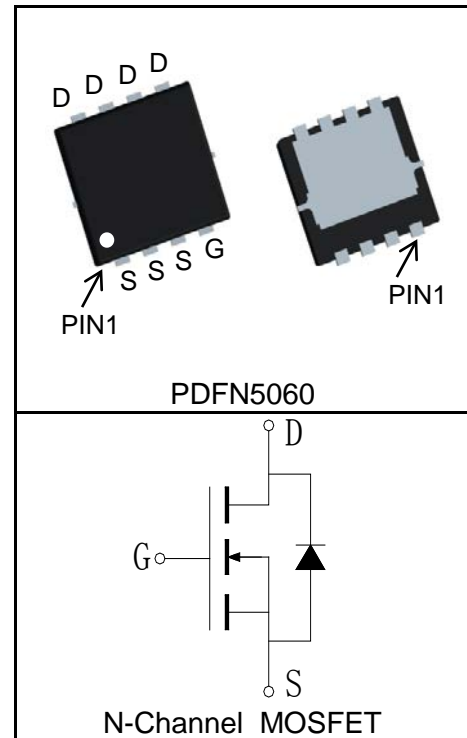

### Absolute Maximum Ratings

Symbol	Parameter	Rating	Unit	
<b>Common Ratings</b> ( $T_C=25^\circ C$ Unless Otherwise Noted)				
$V_{DSS}$	Drain-Source Voltage	40	V	
$V_{GSS}$	Gate-Source Voltage	$\pm 20$		
$T_J$	Maximum Junction Temperature	150	$^\circ C$	
$T_{STG}$	Storage Temperature Range	-55 to 150	$^\circ C$	
$I_S$	Diode Continuous Forward Current	$T_C=25^\circ C$	50	A
<b>Mounted on Large Heat Sink</b>				
$I_{DP}^{①}$	300 $\mu s$ Pulse Drain Current Tested	$T_C=25^\circ C$	480	A
$I_D^{②}$	Continuous Drain Current@ $T_C(V_{GS}=10V)$	$T_C=25^\circ C$	120	A
		$T_C=100^\circ C$	75	
	Continuous Drain Current@ $T_A(V_{GS}=10V)^{③}$	$T_A=25^\circ C$	21	
		$T_A=70^\circ C$	17	
$P_D$	Maximum Power Dissipation@ $T_C$	$T_C=25^\circ C$	96	W
		$T_C=100^\circ C$	38	
	Maximum Power Dissipation@ $T_A^{③}$	$T_A=25^\circ C$	4.2	
		$T_A=70^\circ C$	2.7	

Symbol	Parameter	Rating	Unit
$R_{\theta JC}$	Thermal Resistance-Junction to Case	1.3	°C/W
$R_{\theta JA}^{③}$	Thermal Resistance-Junction to Ambient	30	°C/W
<b>Drain-Source Avalanche Ratings</b>			
$E_{AS}^{④}$	Avalanche Energy, Single Pulsed	400	mJ

**Electrical Characteristics** ( $T_C=25^\circ\text{C}$  Unless Otherwise Noted)

Symbol	Parameter	Test Condition	RU40120M			Unit
			Min.	Typ.	Max.	
<b>Static Characteristics</b>						
$BV_{DSS}$	Drain-Source Breakdown Voltage	$V_{GS}=0V, I_{DS}=250\mu A$	40			V
$I_{DSS}$	Zero Gate Voltage Drain Current	$V_{DS}=40V, V_{GS}=0V$			1	$\mu A$
		$T_J=125^\circ\text{C}$			30	
$V_{GS(th)}$	Gate Threshold Voltage	$V_{DS}=V_{GS}, I_{DS}=250\mu A$	2		4	V
$I_{GSS}$	Gate Leakage Current	$V_{GS}=\pm 20V, V_{DS}=0V$			$\pm 100$	nA
$R_{DS(ON)}^{⑤}$	Drain-Source On-state Resistance	$V_{GS}=10V, I_{DS}=60A$		2.7	4.5	m $\Omega$
<b>Diode Characteristics</b>						
$V_{SD}^{⑤}$	Diode Forward Voltage	$I_{SD}=60A, V_{GS}=0V$			1.2	V
$t_{rr}$	Reverse Recovery Time	$I_{SD}=60A, di_{SD}/dt=100A/\mu s$		33		ns
$Q_{rr}$	Reverse Recovery Charge			30		nC
<b>Dynamic Characteristics</b> <sup>⑥</sup>						
$R_G$	Gate Resistance	$V_{GS}=0V, V_{DS}=0V, F=1\text{MHz}$		1.8		$\Omega$
$C_{iss}$	Input Capacitance	$V_{GS}=0V, V_{DS}=20V, \text{Frequency}=1.0\text{MHz}$		3700		pF
$C_{oss}$	Output Capacitance			680		
$C_{riss}$	Reverse Transfer Capacitance			345		
$t_{d(ON)}$	Turn-on Delay Time		$V_{DD}=20V, I_{DS}=60A, V_{GEN}=10V, R_G=4.7\Omega$		36	
$t_r$	Turn-on Rise Time			205		
$t_{d(OFF)}$	Turn-off Delay Time			85		
$t_f$	Turn-off Fall Time			45		
<b>Gate Charge Characteristics</b> <sup>⑥</sup>						
$Q_g$	Total Gate Charge	$V_{DS}=32V, V_{GS}=10V, I_{DS}=60A$		90		nC
$Q_{gs}$	Gate-Source Charge			32		
$Q_{gd}$	Gate-Drain Charge			37		

**Notes:**

- ① Pulse width limited by safe operating area.
- ② Calculated continuous current based on maximum allowable junction temperature. The package limitation current is 50A.
- ③ When mounted on 1 inch square copper board,  $t \leq 10\text{sec}$ .
- ④ Limited by  $T_{J\text{max}}$ ,  $I_{AS} = 40\text{A}$ ,  $V_{DD} = 32\text{V}$ ,  $R_G = 50\Omega$ , Starting  $T_J = 25^\circ\text{C}$ .
- ⑤ Pulse test; Pulse width  $\leq 300\mu\text{s}$ , duty cycle  $\leq 2\%$ .
- ⑥ Guaranteed by design, not subject to production testing.

**Ordering and Marking Information**

Device	Marking	Package	Packaging	Quantity	Reel Size	Tape width
RU40120M	RU40120M	PDFN5060	Tape&Reel	3000	13"	12mm

**Typical Characteristics**

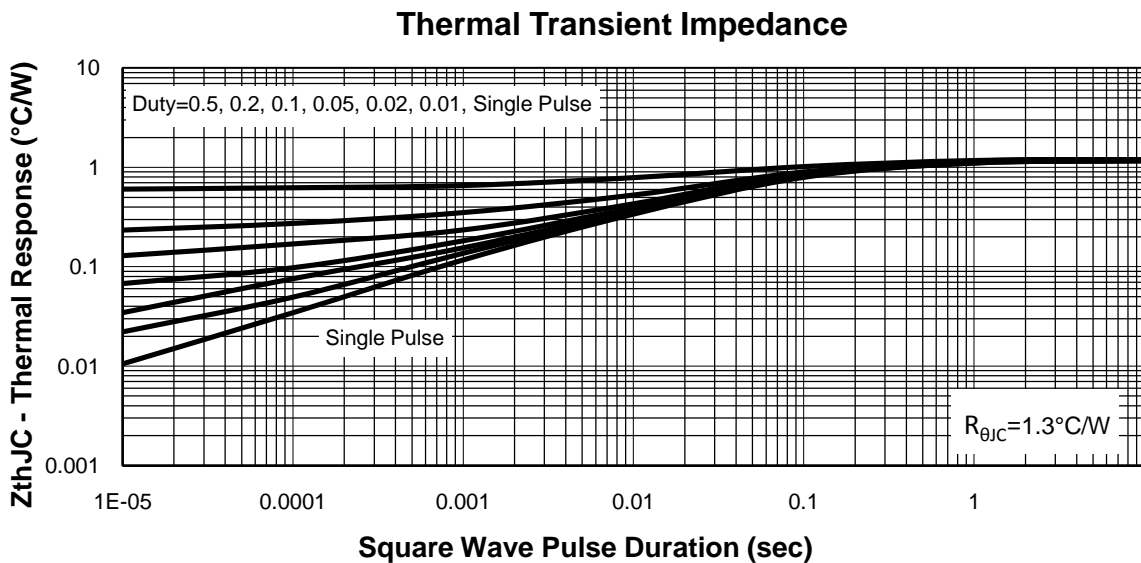
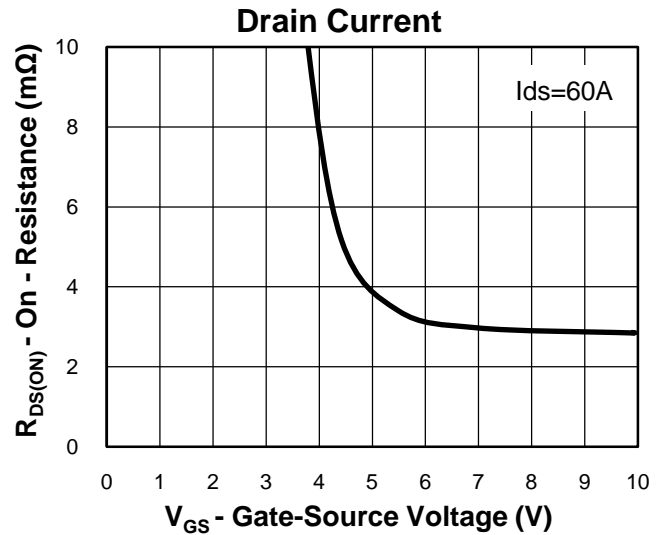
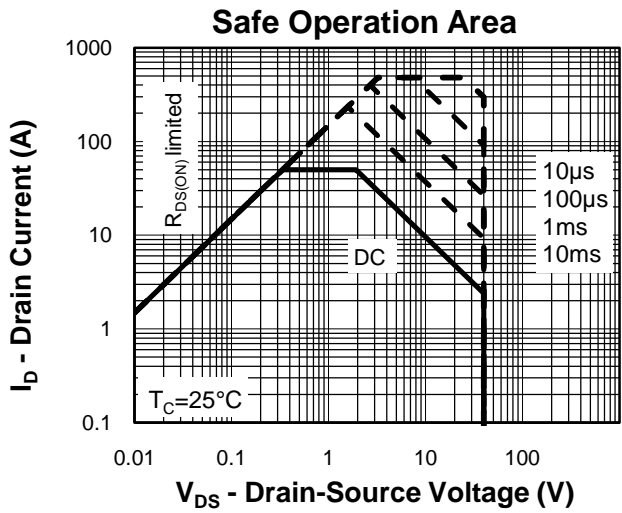
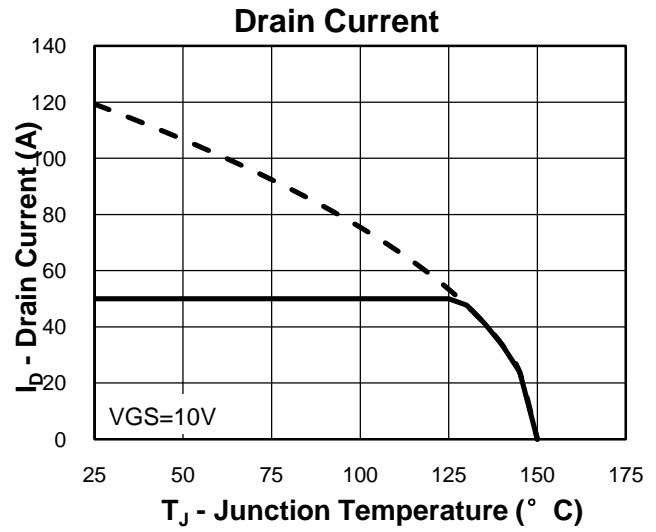
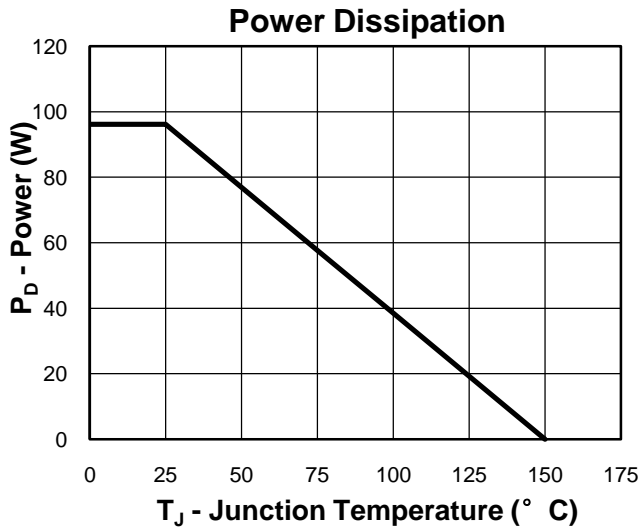

**Typical Characteristics**

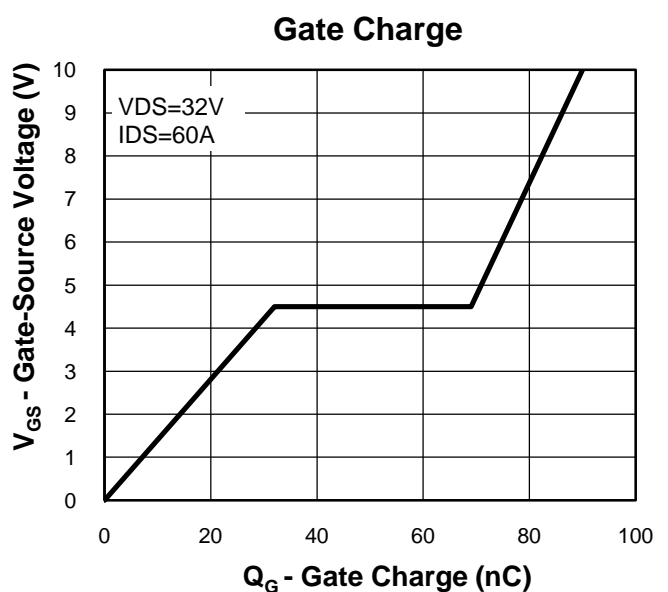
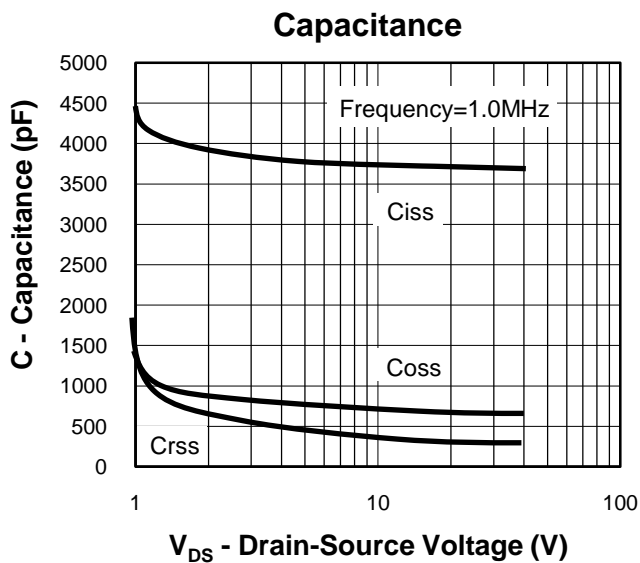
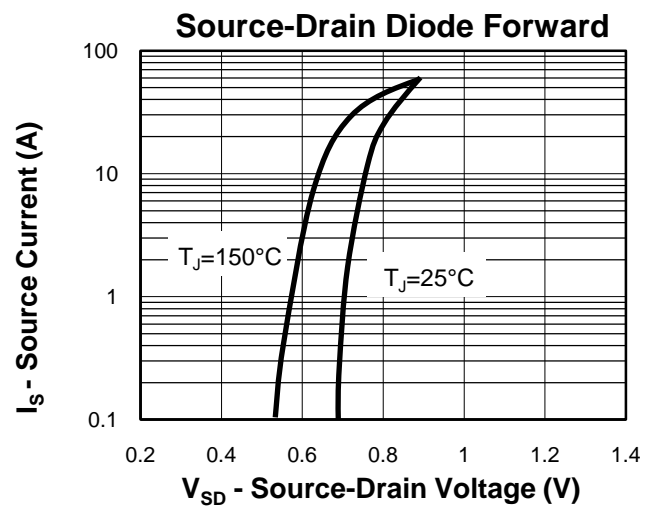
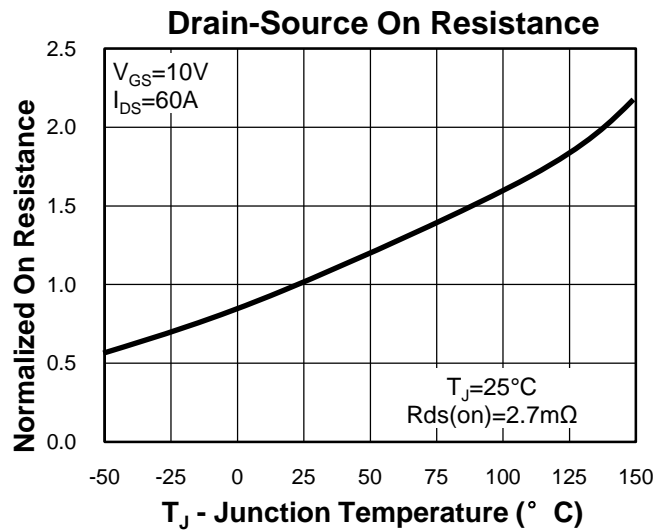
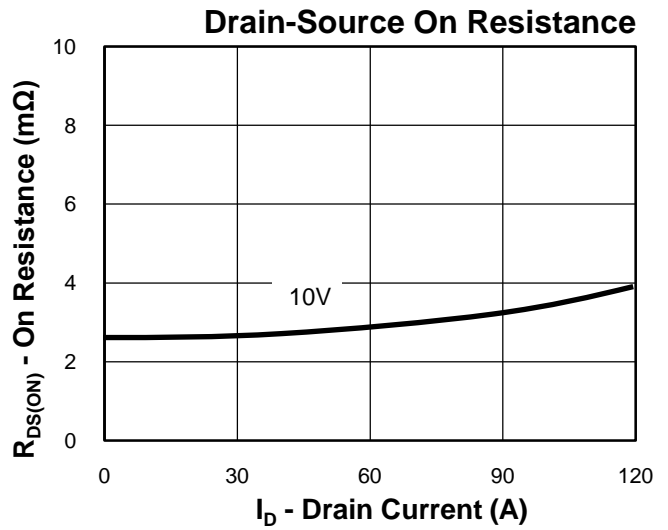
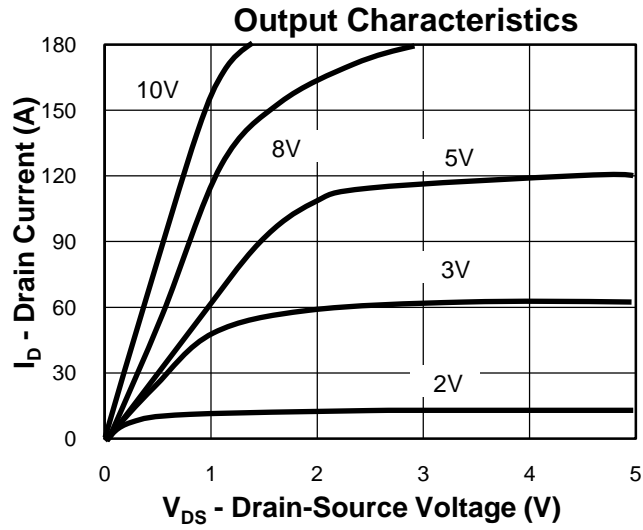

**Avalanche Test Circuit and Waveforms**

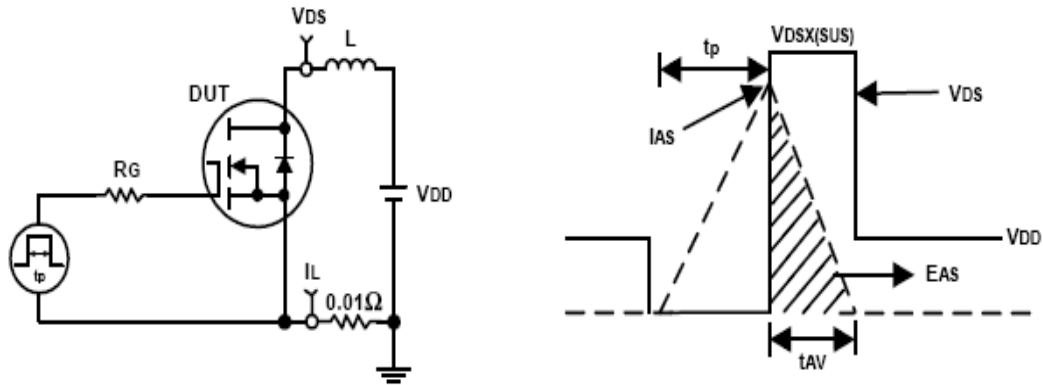

**Switching Time Test Circuit and Waveforms**

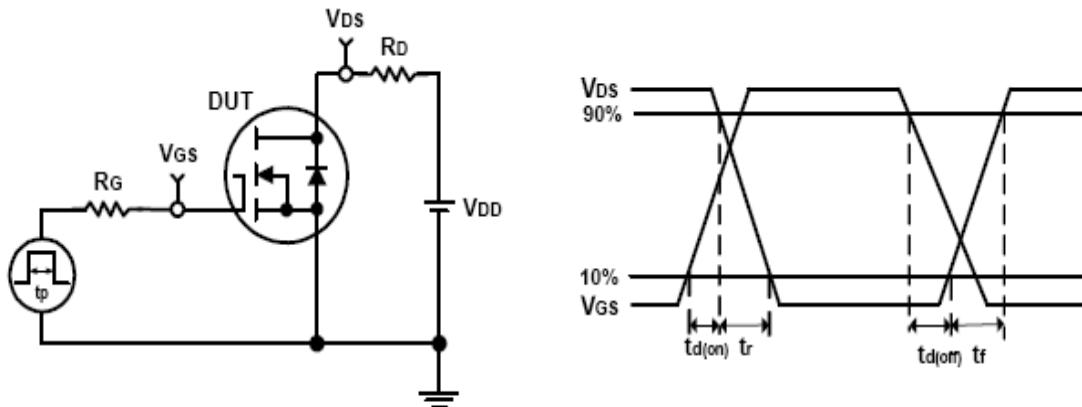

**Package Information**

**PDFN5060**

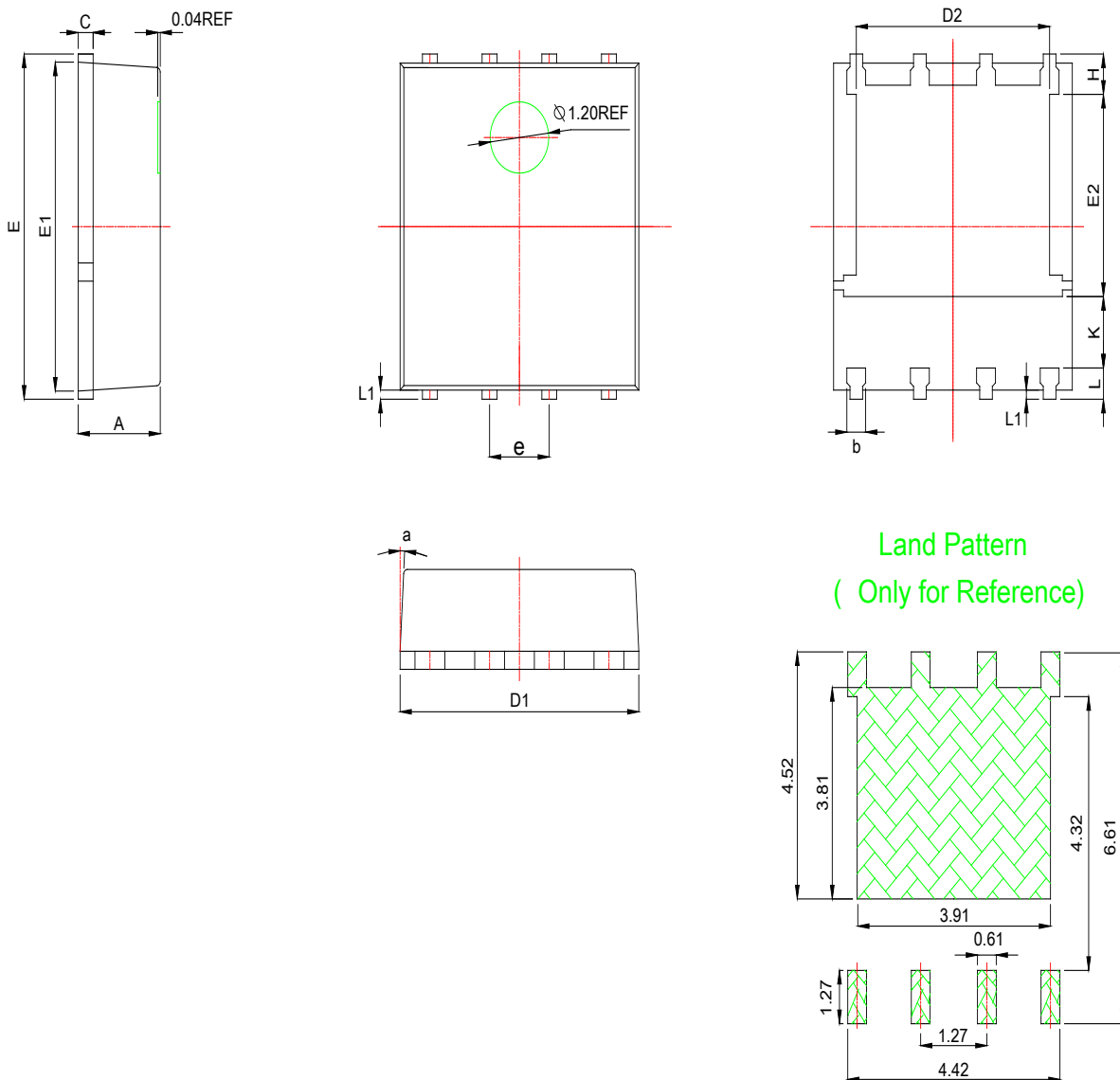

Land Pattern  
( Only for Reference)

SYMBOL	MM			INCH		
	MIN	NOM	MAX	MIN	NOM	MAX
A	0.90	1.00	1.10	0.035	0.039	0.043
b	0.33	0.42	0.51	0.013	0.017	0.020
c	0.20	0.25	0.30	0.008	0.010	0.012
D1	4.80	4.90	5.00	0.189	0.193	0.197
D2	3.61	3.79	3.96	0.142	0.149	0.156
E	5.90	6.00	6.10	0.232	0.236	0.240
E1	5.65	5.75	5.85	0.222	0.226	0.230
E2	3.38	3.58	3.78	0.133	0.141	0.149
e	1.27 BSC			0.005 BSC		
H	0.41	0.51	0.61	0.016	0.020	0.024
k	1.10			0.043		
L	0.51	0.61	0.71	0.020	0.024	0.028
L1	0.06	0.13	0.20	0.002	0.005	0.008
a	0°		12°	0°		12°

**Customer Service****Worldwide Sales and Service:**

Sales@ruichips.com

**Technical Support:**

Technical@ruichips.com

**Investor Relations Contacts:**

Investor@ruichips.com

**Marcom Contact:**

Marcom@ruichips.com

**Editorial Contact:**

Editorial@ruichips.com

**HR Contact:**

HR@ruichips.com

**Legal Contact:**

Legal@ruichips.com

**Shen Zhen RUICHIPS Semiconductor CO., LTD**Room 501, the 5floor An Tong Industrial Building,  
NO.207 Mei Hua Road Fu Tian Area Shen Zhen City, CHINA**TEL:** (86-755) 8311-5334**FAX:** (86-755) 8311-4278**E-mail:** Sales-SZ@ruichips.com