

## LMZ20502 2A SIMPLE SWITCHER® 纳米模块

### 1 特性

- 集成电感
- 采用 3.5mm x 3.5mm x 1.75mm 微型封装
- 最大负载电流为 2A
- 输入电压范围为 2.7V 至 5.5V
- 可调输出电压范围为 0.8V 至 3.6V
- 温度范围内的反馈容差为  $\pm 1\%$
- 关断静态电流最大值为 2.4 $\mu$ A
- 固定脉宽调制 (PWM) 开关频率为 3MHz
- 结温范围为 -40°C 至 125°C
- 电源正常状态标志功能
- 引脚可选开关模式
- 内部补偿和软启动
- 电流限制、热关断和欠压闭锁 (UVLO) 保护

### 2 应用

- 负载点稳压
- 空间受限类应用

### 3 说明

本示例中使用的 LMZ20502 SIMPLE SWITCHER® 纳米模块稳压器是一款易于使用的同步降压 DC-DC 转换器，此转换器能够在高达 5.5V 的输入电压下驱动高达 2A 的负载电流，以极小的解决方案尺寸提供出色的效率和输出精度。这种创新型封装将稳压器和电感器封装在 3.5mm x 3.5mm x 1.75mm 的小尺寸体积中，节省了电路板空间以及电容器选型所需的时间和开销。

LMZ20502 仅需要五个外部组件，其引脚输出设计可实现简单、最优的印刷电路板 (PCB) 布局布线。

LMZ20502 是属于德州仪器 (TI) SIMPLE SWITCHER 系列的一个器件。SIMPLE SWITCHER 的整体设计易于使用，只需最少的外部组件和德州仪器 (TI)

WEBENCH® 设计工具。TI WEBENCH 工具包含多种功能，例如外部组件计算、电气仿真和

WebTherm™。有关焊接的具体信息，请参考以下文档：[SNOA401](#)。

#### 器件信息(1)

器件型号	封装/图纸	封装尺寸 (标称值)
LMZ20502SILT	USIP (8)/SIL0008F	3.50mm x 3.50mm

(1) 要了解所有可用封装，请见数据表末尾的可订购产品附录。

### 4 简化电路原理图

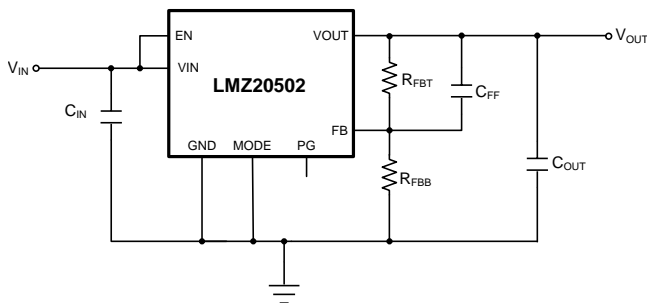

#### $V_{OUT} = 1.8V$ 时自动模式下的典型效率

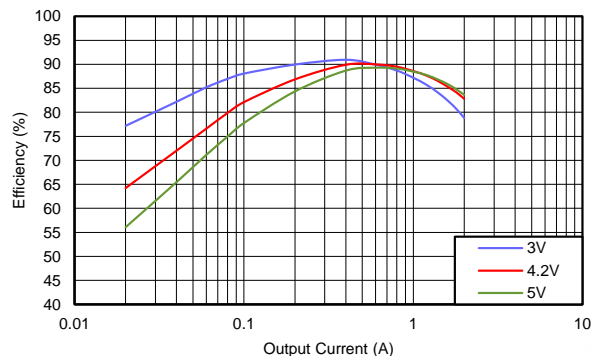

## 目录

<b>1</b>	特性 .....	<b>1</b>	8.3	Feature Description .....	<b>9</b>
<b>2</b>	应用 .....	<b>1</b>	8.4	Device Functional Modes .....	<b>13</b>
<b>3</b>	说明 .....	<b>1</b>	<b>9</b>	<b>Application and Implementation .....</b>	<b>15</b>
<b>4</b>	简化电路原理图 .....	<b>1</b>	9.1	Application Information .....	<b>15</b>
<b>5</b>	修订历史记录 .....	<b>2</b>	9.2	Typical Application .....	<b>16</b>
<b>6</b>	<b>Pin Configuration and Functions .....</b>	<b>3</b>	9.3	Do's and Don'ts .....	<b>23</b>
<b>7</b>	<b>Specifications .....</b>	<b>4</b>	<b>10</b>	<b>Power Supply Recommendations .....</b>	<b>23</b>
7.1	Absolute Maximum Ratings .....	<b>4</b>	<b>11</b>	<b>Layout .....</b>	<b>24</b>
7.2	ESD Ratings .....	<b>4</b>	11.1	Layout Guidelines .....	<b>24</b>
7.3	Recommended Operating Conditions .....	<b>4</b>	11.2	Layout Example .....	<b>25</b>
7.4	Thermal Information .....	<b>5</b>	11.3	Soldering Information .....	<b>25</b>
7.5	Electrical Characteristics .....	<b>6</b>	<b>12</b>	<b>器件和文档支持 .....</b>	<b>27</b>
7.6	System Characteristics .....	<b>7</b>	12.1	器件支持 .....	<b>27</b>
7.7	Typical Characteristics .....	<b>8</b>	12.2	商标 .....	<b>27</b>
<b>8</b>	<b>Detailed Description .....</b>	<b>9</b>	12.3	静电放电警告 .....	<b>27</b>
8.1	Overview .....	<b>9</b>	12.4	术语表 .....	<b>27</b>
8.2	Functional Block Diagram .....	<b>9</b>	<b>13</b>	<b>机械封装和可订购信息 .....</b>	<b>27</b>

## 5 修订历史记录

### Changes from Revision A (July 2013) to Revision B

**Page**

- 已更改 器件信息和处理额定值表，特性描述，器件功能模式，应用和实施，电源相关建议，布局，器件和文档支持，以及机械、封装和可订购信息部分；已将一些曲线移至应用曲线部分。 ..... **1**

## 6 Pin Configuration and Functions

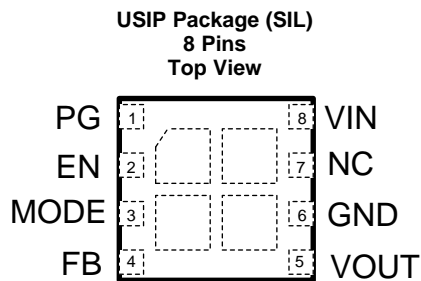

### Pin Functions

PIN		TYPE <sup>(1)</sup>	DESCRIPTION
NUMBER	NAME		
1	PG	O	Power good flag; open drain. Connect to logic supply through a resistor. High = power good; Low = power bad. If not used, leave unconnected.
2	EN	I	Enable input. High = On, Low = Off. A valid input voltage, on pin 8, must be present before EN is asserted. Do not float.
3	MODE	I	Mode selection input. High = forced PWM. Low = AUTO mode, with PFM at light load. Do not float.
4	FB	I	Feedback input to controller. Connect to output through feedback divider.
5	VOUT	P	Regulated output voltage; connect to C <sub>OUT</sub> .
6	GND	G	Ground for all circuitry. Reference point for all voltages.
7	NC		This pin must be left floating. Do not connect to ground or any other node.
8	VIN	P	Input supply to regulator. Connect to input capacitor(s) as close as possible to the VIN pin and GND pin of the module.
EP	EP	G	Ground and heat-sink connection. See <a href="#">Layout Guidelines</a> section for more information.

(1) G = Ground, I = Input, O = Output, P = Power

## 7 Specifications

### 7.1 Absolute Maximum Ratings

Under the recommended operating junction temperature range of -40°C to 125°C (unless otherwise noted) <sup>(1)</sup>

	MIN	MAX	UNIT
V <sub>IN</sub> to GND	-0.2	6	V
EN, MODE, FB, PG, to GND <sup>(2)</sup>	-0.2	V <sub>IN</sub> +0.2	
V <sub>OUT</sub> to GND <sup>(2)</sup>	-0.2	V <sub>IN</sub> +0.2	
Junction temperature		150	°C
Peak soldering reflow temperature for Pb <sup>(3)</sup>		240	°C
Peak soldering reflow temperature for No-Pb <sup>(3)</sup>		260	
Storage temperature range	-65	150	°C

- (1) Stresses beyond those listed under *Absolute Maximum Ratings* may cause permanent damage to the device. These are stress ratings only, which do not imply functional operation of the device at these or any other conditions beyond those indicated under *Recommended Operating Conditions*. Exposure to absolute-maximum-rated conditions for extended periods may affect device reliability.
- (2) The absolute maximum voltage on this pin must not exceed 6V with respect to ground. Do not allow the voltage on the output pin to exceed the voltage on the input pin by more than 0.2 V.
- (3) For soldering information, please refer to the following document: [SNOA401](#).

### 7.2 ESD Ratings

			VALUE	UNIT
V <sub>(ESD)</sub>	Electrostatic discharge	Human body model (HBM), per ANSI/ESDA/JEDEC JS-001, all pins <sup>(1)</sup>	±2000	V
		Charged-device model (CDM), per JEDEC specification JESD22-C101, all pins <sup>(2)</sup>	±500	

- (1) JEDEC document JEP155 states that 500-V HBM allows safe manufacturing with a standard ESD control process.
- (2) JEDEC document JEP157 states that 250-V CDM allows safe manufacturing with a standard ESD control process.

### 7.3 Recommended Operating Conditions

Under the recommended operating junction temperature range of -40°C to 125°C (unless otherwise noted) <sup>(1)</sup>

	MIN	NOM	MAX	UNIT
Input voltage	2.7		5.5	V
Output voltage programming	0.8		3.6	V
Output voltage range <sup>(2)</sup>	0		3.6	V
Load current	0		2	A
Power good flag current	0		4	mA
Junction temperature	-40		125	°C

- (1) Stresses beyond those listed under *Absolute Maximum Ratings* may cause permanent damage to the device. These are stress ratings only, which do not imply functional operation of the device at these or any other conditions beyond those indicated under *Recommended Operating Conditions*. Exposure to absolute-maximum-rated conditions for extended periods may affect device reliability.
- (2) Under no conditions should the output voltage be allowed to fall below zero volts.

## 7.4 Thermal Information

THERMAL METRIC <sup>(1)</sup>		LMZ20502	UNIT
		USIP (SIL)	
		8 PINS	
$R_{\theta JA}$	Junction-to-ambient thermal resistance	42.6	°C/W
$R_{\theta JC(top)}$	Junction-to-case (top) thermal resistance	20.8	
$R_{\theta JB}$	Junction-to-board thermal resistance	9.4	
$\Psi_{JT}$	Junction-to-top characterization parameter	1.5	
$\Psi_{JB}$	Junction-to-board characterization parameter	9.3	
$R_{\theta JC(bot)}$	Junction-to-case (bottom) thermal resistance	1.8	

- (1) The values given in this table are only valid for comparison with other packages and can not be used for design purposes. For design information please see the [Maximum Ambient Temperature](#) section. For more information about traditional and new thermal metrics, see the *IC Package Thermal Metrics* application report, [SPRA953](#).

## 7.5 Electrical Characteristics

Limits apply over the recommended operating junction temperature range of  $-40^{\circ}\text{C}$  to  $125^{\circ}\text{C}$ , unless otherwise noted. Minimum and maximum limits are verified through test, design, or statistical correlation. Typical values represent the most likely parametric norm at  $T_J = 25^{\circ}\text{C}$ , and are provided for reference purposes only. Unless otherwise stated the following conditions apply:  $V_{IN} = 3.6\text{ V}$

PARAMETER	TEST CONDITIONS	MIN <sup>(1)</sup>	TYP	MAX <sup>(1)</sup>	UNIT	
$V_{FB}$	Feedback voltage	$V_{IN} = 3.6\text{ V}$	0.594	0.6	0.606	V
$I_{Q\_AUTO}$	Operating quiescent current in AUTO mode	AUTO mode, $V_{FB} = 0.8\text{V}$	72	90		$\mu\text{A}$
$I_{Q\_PWM}$	Operating quiescent current in forced PWM mode	PWM mode, $V_{FB} = 0.8\text{V}$	490	620		$\mu\text{A}$
$I_{Q\_off}$	Shutdown quiescent current <sup>(2)</sup>	$V_{IN} = 3.6\text{ V}, V_{EN} = 0.0\text{ V}$	0.7	1.5		$\mu\text{A}$
		$V_{IN} = 5.5\text{ V}, V_{EN} = 0.0\text{ V}$	1.0	2.4		
$V_{UVLO}$	Input supply under-voltage lock-out thresholds	Rising	2.5			V
		Falling	2.3			
$V_{EN}$	High Level Input Voltage	$V_{IH}$	1.4			V
	Low Level Input Voltage	$V_{IL}$		0.4		
$V_{MODE}$	High Level Input Voltage	$V_{IH}$	1.2			V
	Low Level Input Voltage	$V_{IL}$		0.4		
$I_{LIM}$	Peak switch current limit <sup>(3)</sup>		2.1	2.7		A
$F_{osc}$	Internal oscillator frequency		2.5	3.0	3.2	MHz
$T_{ON}$	Minimum switch on-time <sup>(4)</sup>		50			ns
$T_{ss}$	Soft start time <sup>(4)</sup>		800			$\mu\text{s}$
$R_{PG}$	Power good flag pull-down $R_{dson}$		40	70	110	$\Omega$
$V_{PG1}$	Power good flag, under-voltage trip <sup>(5)</sup>	% of feedback voltage, rising	92%			
$V_{PG2}$	Power good flag, under-voltage trip <sup>(5)</sup>	% of feedback voltage, falling	88%			
$V_{PG3}$	Power good flag, over-voltage trip <sup>(5)</sup>	% of feedback voltage, rising	112%			
$V_{PG4}$	Power good flag, over-voltage trip <sup>(5)</sup>	% of feedback voltage, falling	108%			
$T_{SD}$	Thermal shutdown <sup>(4)</sup>	Rising threshold	159			$^{\circ}\text{C}$
	Thermal shutdown hysteresis <sup>(4)</sup>		15			$^{\circ}\text{C}$

- (1) MIN and MAX limits are 100% production tested at  $25^{\circ}\text{C}$ . Limits over the operating temperature range are verified through correlation using Statistical Quality Control (SQC) methods. Limits are used to calculate Average Outgoing Quality Level (AOQL).
- (2) Shutdown current includes leakage current of the switching transistors.
- (3) This is the peak switch current limit measured with a slow current ramp. Due to inherent delays in the current limit comparator, the peak current limit measured at 3MHz will be larger.
- (4) This parameter is not tested in production.
- (5) See [Power Good Flag Function](#) for explanation of voltage levels.

## 7.6 System Characteristics

The following specifications apply to the circuit found in [Figure 16](#) with the appropriate modifications from [Table 2](#). **These parameters are not tested in production and represent typical performance only.** Unless otherwise stated the following conditions apply:  $T_A = 25^\circ\text{C}$ .

PARAMETER		TEST CONDITIONS	MIN	TYP	MAX	UNIT
Load Regulation	Percent output voltage change for the given load current change	$V_{OUT} = 1.2\text{ V}$ , $V_{IN} = 5\text{ V}$ , $I_{OUT} = 0\text{ A to } 2\text{ A}$ , PWM		0.4%		
		$V_{OUT} = 1.8\text{ V}$ $V_{IN} = 5\text{ V}$ , $I_{OUT} = 0\text{ A to } 2\text{ A}$ , PWM		0.4%		
		$V_{OUT} = 3.3\text{ V}$ $V_{IN} = 5\text{ V}$ , $I_{OUT} = 0\text{ A to } 2\text{ A}$ , PWM		0.2%		
Line Regulation	Percent output voltage change for the given change in input voltage	$V_{OUT} = 1.2\text{ V}$ $I_{OUT} = 2\text{ A}$ , $V_{IN} = 3\text{ V to } 5\text{ V}$ , PWM		0.2%		
		$V_{OUT} = 1.8\text{ V}$ $I_{OUT} = 2\text{ A}$ , $V_{IN} = 3\text{ V to } 5\text{ V}$ , PWM		0.15%		
		$V_{OUT} = 3.3\text{ V}$ $I_{OUT} = 2\text{ A}$ , $V_{IN} = 4\text{ V to } 5\text{ V}$ , PWM		0.18%		
$V_{R-PWM}$	Output voltage ripple in PWM	$V_{OUT} = 1.2\text{ V}$ $I_{OUT} = 1\text{ A}$ , $V_{IN} = 5\text{ V}$ , PWM		3.3		mV pk-pk
		$V_{OUT} = 1.8\text{ V}$ $I_{OUT} = 1\text{ A}$ , $V_{IN} = 5\text{ V}$ , PWM		3.3		
		$V_{OUT} = 3.3\text{ V}$ $I_{OUT} = 1\text{ A}$ , $V_{IN} = 5\text{ V}$ , PWM		4.2		
$V_{R-PFM}$	Output voltage ripple in PFM	$V_{OUT} = 1.2\text{ V}$ $I_{OUT} = 1\text{ mA}$ , $V_{IN} = 3\text{ V}$ , PFM		22		mV pk-pk
		$V_{OUT} = 1.8\text{ V}$ $I_{OUT} = 1\text{ mA}$ , $V_{IN} = 3\text{ V}$ , PFM		22		
		$V_{OUT} = 3.3\text{ V}$ $I_{OUT} = 1\text{ mA}$ , $V_{IN} = 5\text{ V}$ , PFM		40		
Load Transient	Output voltage deviation from nominal due to a load current step	$V_{OUT} = 1.2\text{ V}$ $V_{IN} = 5\text{ V}$ , $I_{OUT} = 0\text{ A to } 2\text{ A}$ , $T_r = T_f = 2\text{ }\mu\text{s}$ , PWM		$\pm 115$		mV
		$V_{OUT} = 1.8\text{ V}$ $V_{IN} = 5\text{ V}$ , $I_{OUT} = 0\text{ A to } 2\text{ A}$ , $T_r = T_f = 2\text{ }\mu\text{s}$ , PWM		$\pm 100$		
		$V_{OUT} = 3.3\text{ V}$ $V_{IN} = 5\text{ V}$ , $I_{OUT} = 0\text{ A to } 2\text{ A}$ , $T_r = T_f = 2\text{ }\mu\text{s}$ , PWM		$\pm 150$		
Line Transient	Output voltage deviation due to an input voltage step	$V_{OUT} = 1.2\text{ V}$ $I_{OUT} = 1\text{ A}$ , $V_{IN} = 3\text{ V to } 5\text{ V}$ , $T_r = T_f = 50\text{ }\mu\text{s}$ , PWM		25		mV pk-pk
		$V_{OUT} = 1.8\text{ V}$ $I_{OUT} = 1\text{ A}$ , $V_{IN} = 3\text{ V to } 5\text{ V}$ , $T_r = T_f = 50\text{ }\mu\text{s}$ , PWM		30		
		$V_{OUT} = 3.3\text{ V}$ $I_{OUT} = 1\text{ A}$ , $V_{IN} = 4\text{ V to } 5\text{ V}$ , $T_r = T_f = 50\text{ }\mu\text{s}$ , PWM		20		
$\eta$	Peak efficiency	$V_{OUT} = 1.2\text{ V}$ $V_{IN} = 3\text{ V}$		87%		
		$V_{OUT} = 1.8\text{ V}$ $V_{IN} = 3\text{ V}$		91%		
		$V_{OUT} = 3.3\text{ V}$ $V_{IN} = 4.2\text{ V}$		94%		
	Full load efficiency	$V_{OUT} = 1.2\text{ V}$ $V_{IN} = 3\text{ V}$ , $I_{OUT} = 2\text{ A}$		74%		
		$V_{OUT} = 1.8\text{ V}$ $V_{IN} = 3\text{ V}$ , $I_{OUT} = 2\text{ A}$		79%		
		$V_{OUT} = 3.3\text{ V}$ $V_{IN} = 4.2\text{ V}$ , $I_{OUT} = 2\text{ A}$		89%		

## 7.7 Typical Characteristics

Unless otherwise specified the following conditions apply:  $V_{IN} = 3.6\text{ V}$ ,  $T_A = 25^\circ\text{C}$ .

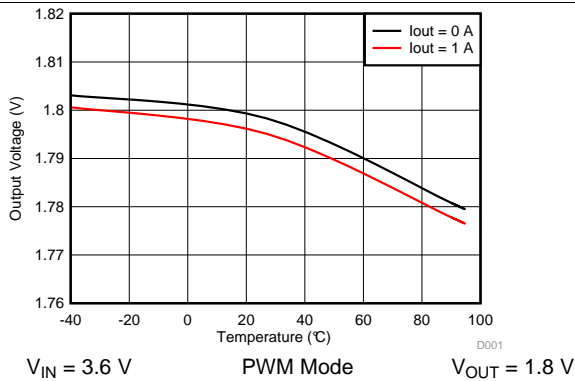

Figure 1. Typical Output Voltage vs Temperature

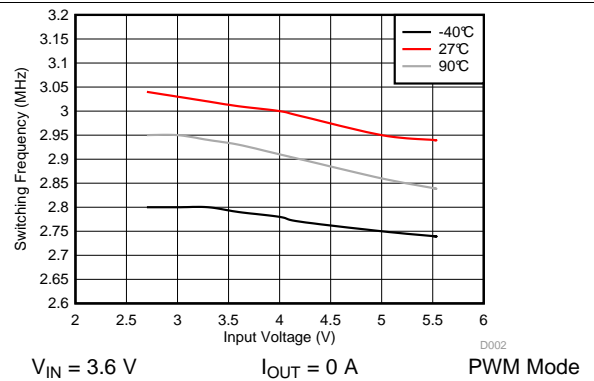

Figure 2. Switching Frequency in PWM Mode

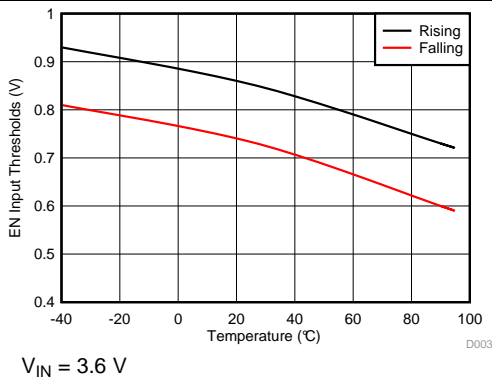

Figure 3. EN Input Thresholds

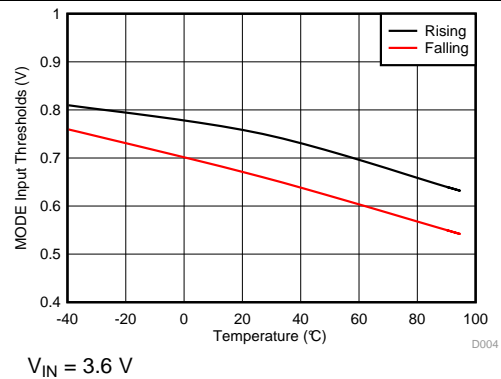

Figure 4. MODE Input Thresholds

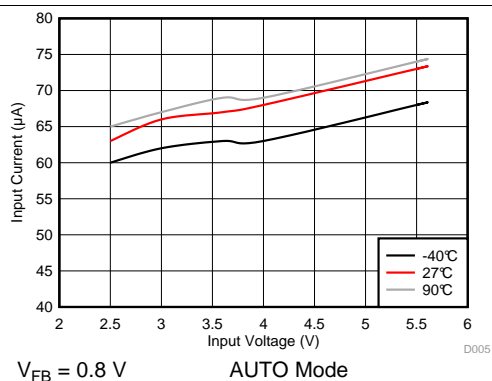

Figure 5. Non-Switching Input Current in AUTO Mode

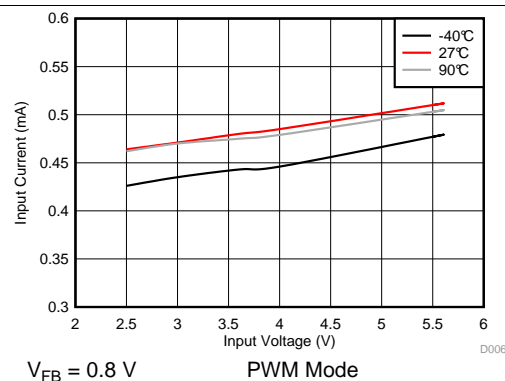

Figure 6. Non-Switching Input Current in PWM Mode



## 8 Detailed Description

### 8.1 Overview

The LMZ20502 SIMPLE SWITCHER Nano Module is a voltage mode buck regulator with an integrated inductor. Input voltage feed-forward is used to compensate for loop gain variation with input voltage. Two operating modes allow the user to tailor the regulator to their specific requirements. In forced PWM mode, the regulator operates as a full synchronous device with a 3 MHz (typ.) switching frequency and very low output voltage ripple. In AUTO mode, the regulator moves into PFM when the load current drops below the mode change threshold (see [Application Curves](#)). In PFM, the device regulates the output voltage between wider ripple limits than in PWM. This results in much smaller supply current than in PWM, at light loads and high efficiency. A simplified block diagram is shown in [Functional Block Diagram](#).

### 8.2 Functional Block Diagram

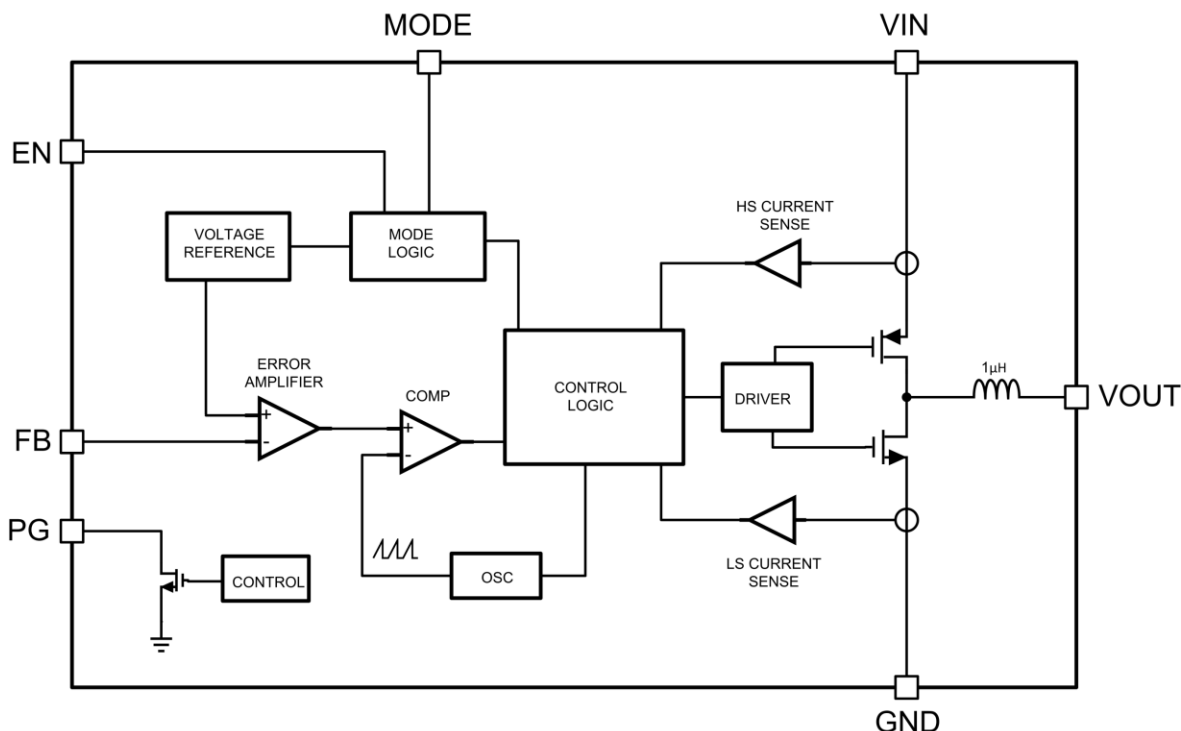

### 8.3 Feature Description

#### 8.3.1 Nano Scale Package

The LMZ20502 incorporates world class package technology to provide a 2 A power supply with a total volume of only 21 mm<sup>3</sup> (excluding external components). All that is required for a complete power supply is the addition of feed-back resistors to set the output voltage and the input and output filter capacitors. [Figure 7](#) and [Figure 8](#) show the LMZ20502 package. The regulator die is embedded into a PCB substrate while the power inductor is mounted on top. Vias and copper clad are used to make the connections to the die, inductor and the external components. This package is MSL3 compliant.

## Feature Description (continued)

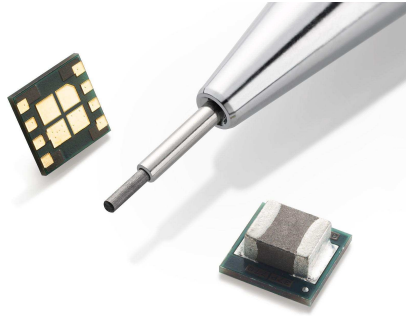

**Figure 7. Package Photo**

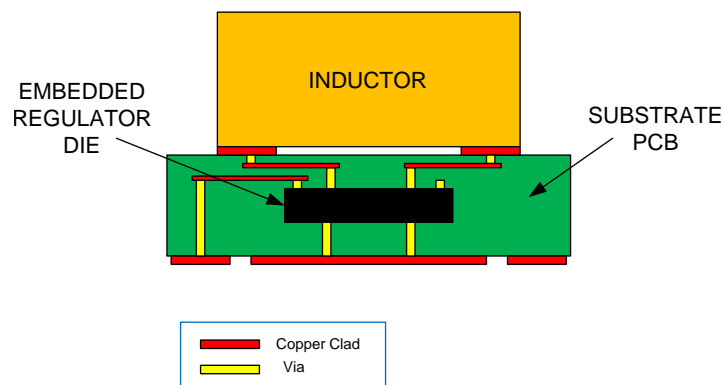

**Figure 8. Package Side View Drawing**

### 8.3.2 Internal Synchronous Rectifier

The LMZ20502 uses an internal NMOS FET as a synchronous rectifier to minimize switch voltage drop and increase efficiency. The NMOS is designed to conduct through its body diode during switch dead time. This dead time is imposed to prevent supply current "shoot-through".

### 8.3.3 Current Limit Protection

The LMZ20502 incorporates cycle-by-cycle peak current limit on both the high and low side MOSFETs. This feature limits the output current in case the output is overloaded. During the overload, the peak inductor current is limited to that value found in the [Electrical Characteristics](#) table under the heading of " $I_{LIM}$ ".

In addition to current limit, a short circuit protection mode is also implemented. When the feedback voltage is brought down to less than 300 mV, but greater than 150 mV, by a short circuit, the synchronous rectifier is turned off. This provides more voltage across the inductor to help maintain the required volt-second balance. If a "harder" short brings the feedback voltage to below 150 mV, the current limit and switching frequency are both reduced to about  $\frac{1}{2}$  of the nominal values. In addition, when the current limit is tripped, the device stops switching for about 85  $\mu$ s. At the end of the time-out, switching resumes and the cycle repeats until the short is removed.

The effect of both overload and short circuit protection can be seen in [Figure 9](#). This graph demonstrates that the device will supply slightly more than 2 A to the load when in overload and much less current during fold-back mode. This is typical behavior for any regulator with this type of current limit protection.

### Feature Description (continued)

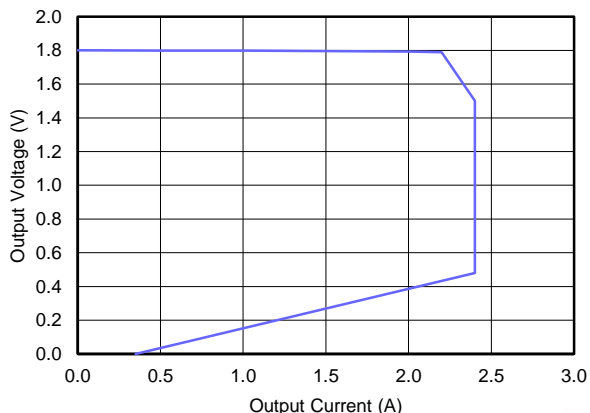
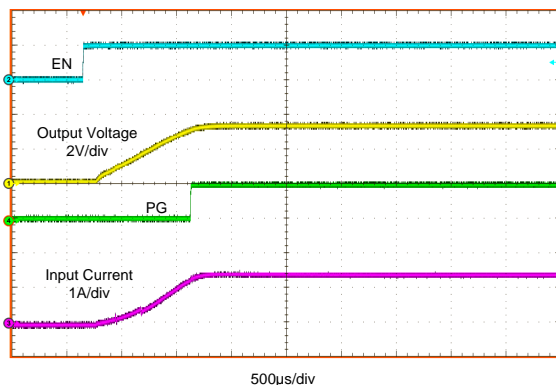

**Figure 9. Typical Current Limit Profile**  
 $V_{IN} = 5\text{ V}$ ,  $V_{OUT} = 1.8\text{ V}$

#### 8.3.4 Start-Up

Start-up and shutdown of the LMZ20502 is controlled by the EN input. The characteristics of this input are found in the *Electrical Characteristics* table. A valid input voltage must be present on VIN before the enable control is asserted. The maximum voltage on the EN pin is 5.5 V or  $V_{IN}$ , whichever is smaller. Do not allow this input to float.

The LMZ20502 features a current limit based soft-start, that prevents large inrush currents and output overshoots as the regulator is starting up. The peak inductor current is stepped-up in a staircase fashion during the soft start period. A typical start-up event is shown in Figure 10:



**Figure 10. Typical Start-Up Waveforms,  $V_{IN} = 5\text{ V}$ ,  $V_{OUT} = 3.3\text{ V}$ ,  $I_{OUT} = 1\text{ A}$**

#### 8.3.5 Drop-Out Behavior

When the input voltage is close to the output voltage the regulator will operate at very large duty cycles. Normal time delays of the internal circuits prevents the attainment of controlled duty cycles near 100%. In this condition the LMZ20502 will skip switching cycles in order to maintain regulation with the highest possible input-to-output ratio. Some increase in output voltage ripple may appear as the regulator skips cycles. As the input voltage gets closer to the output voltage, the regulator will eventually reach 100% duty cycle, with the high side switch turned on. The output will then follow the input voltage minus the drop across the high side switch and inductor resistance. Figure 11 and Figure 12 show typical drop-out behavior for output voltages of 2.5 V and 3.3 V.

## Feature Description (continued)

Since the internal gate drive levels of the LMZ20502 are dependent on input voltage, the  $R_{\text{dson}}$  of the power FETs will increase at low input voltages. This will result in degraded efficiency at output currents of greater than 1 A and input voltages below about 2.9 V. Also, combinations of low input voltage and high output voltage increases the effective switch duty cycle which may result in increased output voltage ripple.

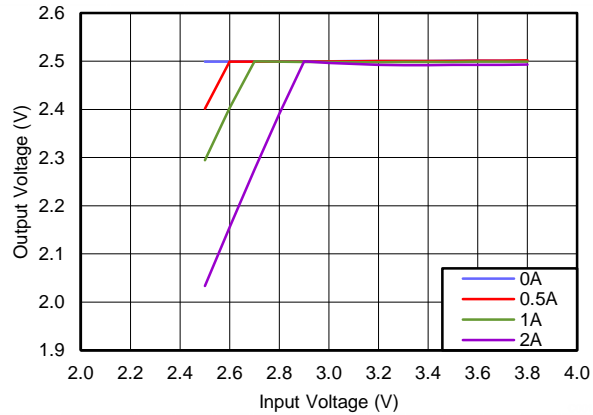

**Figure 11. Typical Drop-Out Behavior,  $V_{\text{OUT}} = 2.5 \text{ V}$**

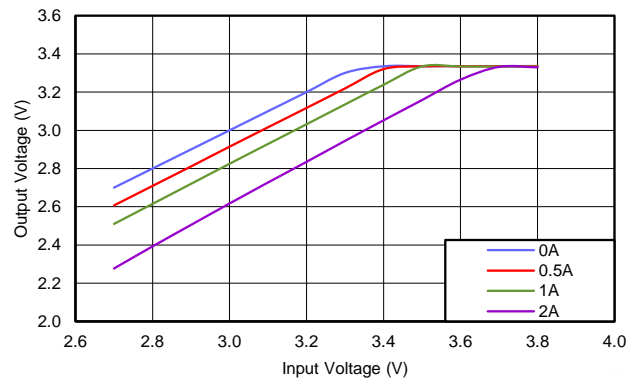

**Figure 12. Typical Drop-Out Behavior,  $V_{\text{OUT}} = 3.3 \text{ V}$**

### 8.3.6 Power Good Flag Function

The operation of the power good flag function is described in the diagram shown in [Figure 13](#).

Feature Description (continued)

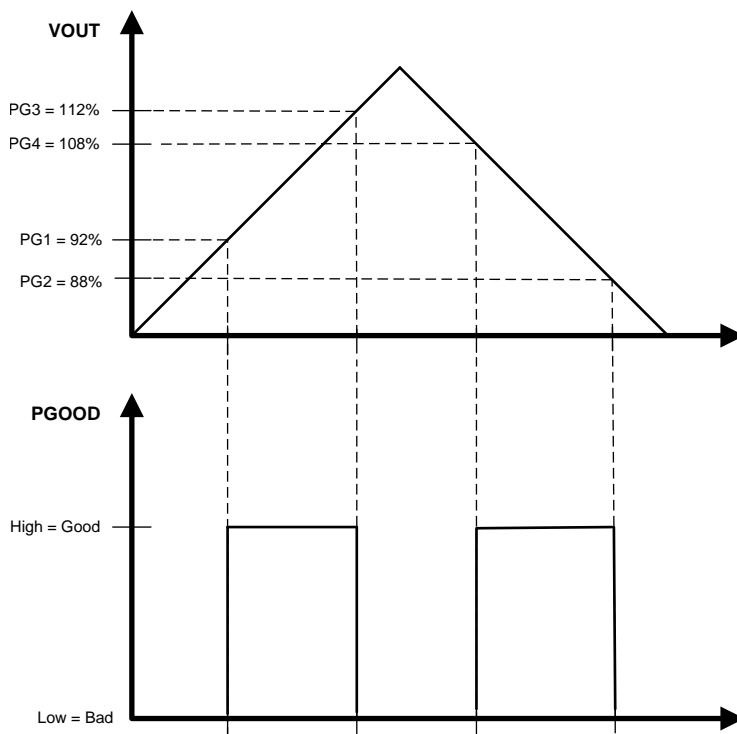

Figure 13. Typical Power Good Flag Operation

This output consists of an open drain NMOS with an  $R_{dson}$  of about 70  $\Omega$ . When used, the power good flag should be connected to a logic supply through a pull-up resistor. It can also be pulled-up to either  $V_{IN}$  or  $V_{OUT}$ , through an appropriate resistor, as desired. If this function is not needed, the PG output should be left floating. The current through this flag pin should be limited to less than 4 mA. A pull-up resistor of  $\geq 1.5$  k $\Omega$  will satisfy this requirement. When the EN input is pulled low, the PG flag output will also be forced low, assuming a valid input voltage is present at the VIN pin.

8.3.7 Thermal Shutdown

The LMZ20502 incorporates a thermal shutdown feature to protect the device from excessive die temperatures. The device will stop switching when the internal die temperature reaches about 159°C. Switching will resume when the die temperature drops to about 144°C.

8.4 Device Functional Modes

Please refer to Table 1 and the following paragraphs for a detailed description of the functional modes of the LMZ20502. These modes are controlled by the MODE input as shown in Table 1. The maximum voltage on the MODE pin is 5.5 V or  $V_{IN}$ , whichever is smaller. This input must not be allowed to float.

Table 1. Mode Selection

MODE PIN VOLTAGE	OPERATION
> 1.2 V	Forced PWM: The regulator operates in constant frequency, PWM mode for all loads from no-load to full load; no diode emulation is used.
< 0.4 V	AUTO Mode: The regulator operates in constant frequency mode for loads greater than the mode change threshold. For loads less than the mode change threshold, the regulator operates in PFM with diode emulation.

### 8.4.1 PWM Operation

In forced PWM mode, the converter operates as a constant frequency voltage mode regulator with input voltage feed-forward. This provides excellent line and load regulation and low output voltage ripple. This operation is maintained, even at no-load, by allowing the inductor current to reverse its normal direction. While in PWM mode, the output voltage is regulated by switching at a constant frequency and modulating the duty cycle to control the power to the load. This mode trades off reduced light load efficiency for low output voltage ripple and constant switching frequency. In this mode, a negative current limit of about 750mA is imposed to prevent damage to the regulator power FETs.

### 8.4.2 PFM Operation

When in AUTO mode, and at light loads, the device enters PFM. The regulator estimates the load current by measuring both the high side and low side switch currents. This estimate is only approximate, and the exact load current threshold, to trigger PFM, can vary greatly with input and output voltage. The [Application Curves](#) show mode change thresholds for several typical operating points. When the regulator detects this threshold, the reference voltage is increased by approximately 10 mV. This causes the output voltage to rise to meet the new regulation point. When this point is reached, the converter stops switching and much of the internal circuitry is shut off, while the reference is returned to the PWM value. This saves supply current while the output voltage naturally starts to fall under the influence of the load current. When the output voltage reaches the PWM regulation point, switching is again started and the reference voltage is again increased by about 10 mV; thus starting the next cycle. Typical waveforms are shown in [Figure 14](#):

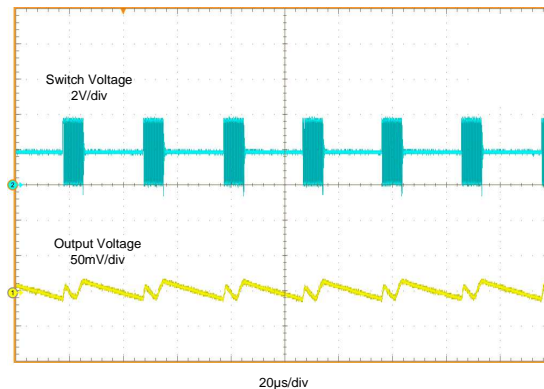

**Figure 14. Typical PFM Mode Waveforms:  $V_{IN} = 3.6\text{ V}$ ,  $V_{OUT} = 1.8\text{ V}$ ,  $I_{OUT} = 10\text{ mA}$**

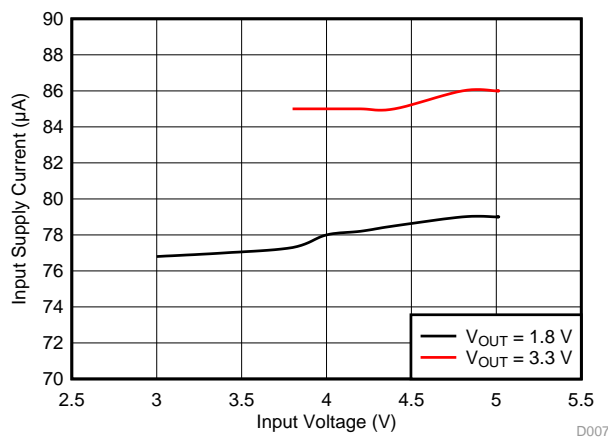

**Figure 15. Typical No Load Input Supply Current**

The actual output voltage ripple will depend on the feedback divider ratio and on the delay in the PFM comparator. The frequency of the PFM "bursts" will depend on the input voltage, output voltage, load and output capacitor. Within each "burst" the device switches at 3 MHz (typ.). If the load current increases above the threshold, normal PWM operation is resumed. This mode provides high light load efficiency by reducing the amount of supply current required to regulate the output at small load currents. This mode trades off very good light load efficiency for larger output voltage ripple and variable switching frequency. An example of the typical input supply current, while regulating with no load, is shown in [Figure 15](#).

Because of normal part-to-part variation, the LMZ20502 may not switch into PFM mode at high input voltages. This may be seen with output voltages of about 1.2 V and below, at input voltages of about 4.2 V and above.

## 9 Application and Implementation

---

### NOTE

Information in the following applications sections is not part of the TI component specification, and TI does not warrant its accuracy or completeness. TI's customers are responsible for determining suitability of components for their purposes. Customers should validate and test their design implementation to confirm system functionality.

---

### 9.1 Application Information

The LMZ20502 is a step down DC-to-DC regulator. It is typically used to convert a higher DC voltage to a lower DC voltage with a maximum output current of 2 A. The following design procedure can be used to select components for the LMZ20502. Alternately, the WEBENCH design tool may be used to generate a complete design. WEBENCH utilizes an iterative design procedure and has access to a comprehensive database of components. This allows the tool to create an optimized design and allows the user to experiment with various design options.

## 9.2 Typical Application

Figure 16 shows the minimum required application circuit, set up for a 1.8 V output. Figure 17 shows a full featured application circuit. Please refer to Figure 16 and Figure 17 during the following design procedures.

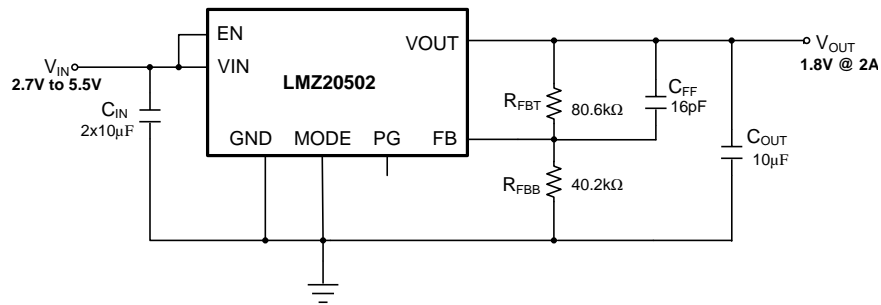

Figure 16. LMZ20502 Typical Application  
 $V_{OUT} = 1.8\text{ V}$

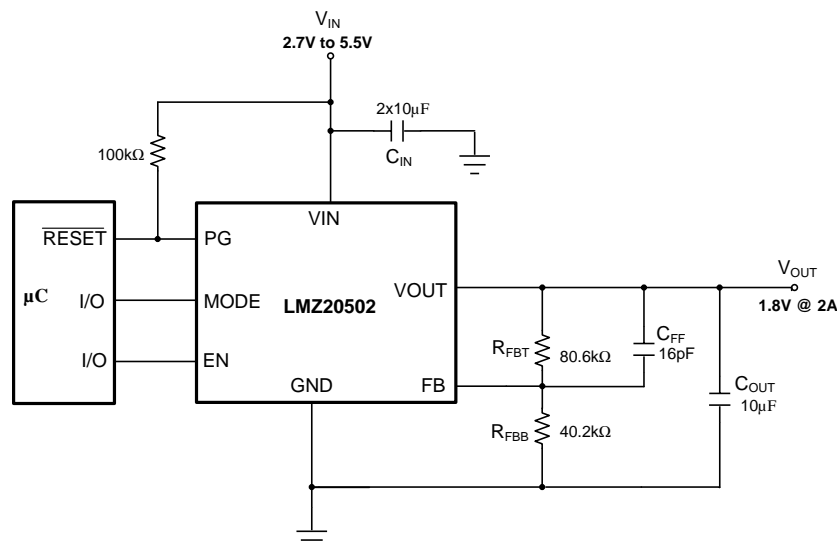

Figure 17. LMZ20502 Full Featured Application



## Typical Application (continued)

### 9.2.1 Detailed Design Procedure

Please refer to [Table 2](#) while following the detailed design procedure. This procedure applies to both [Figure 16](#) and to [Figure 17](#). Also, the [Application Curves](#) apply to both schematics.

**Table 2. Recommended Component Values<sup>(1)</sup>**

V <sub>OUT</sub> (V)	R <sub>FBB</sub> (kΩ)	R <sub>FBT</sub> (kΩ)	C <sub>OUT</sub> (μF)	EFFECTIVE C <sub>OUT</sub> (μF) <sup>(2)</sup>	C <sub>FF</sub> (pF)	C <sub>IN</sub> (μF)	EFFECTIVE C <sub>IN</sub> (μF) <sup>(2)</sup>
0.8	121	40.2	2 x 10	18 μF	39	2 x 10	14
1.2	30.1	30.1	10	8.8 μF	20	2 x 10	14
1.8	40.2	80.6	10	8.4 μF	16	2 x 10	14
2.5	47.5	150	10	7.8 μF	12	2 x 10	14
3.3	53.2	237	10	7.1 μF	82	2 x 10	14
3.6	53.2	267	10	6.8 μF	82	2 x 10	14

(1) C<sub>IN</sub> = C<sub>OUT</sub> = 10 μF, 16 V, 0805, X7R, Samsung CL21B106K0QNNNE. C<sub>OUT</sub> measured at V<sub>OUT</sub>; C<sub>IN</sub> measured at 3.3 V.

(2) The effective value takes into account the capacitor voltage coefficient.

#### 9.2.1.1 Setting The Output Voltage

The LMZ20502 regulates its feedback voltage to 0.6 V (typ). A feedback divider, shown in [Figure 16](#), is used to set the desired output voltage. [Equation 1](#) can be used to select R<sub>FBB</sub>.

$$R_{FBB} = \frac{0.6}{(V_{OUT} - 0.6)} \cdot R_{FBT} \quad (1)$$

For best results, R<sub>FBT</sub> should be chosen between 30 kΩ and 300 kΩ. See [Table 2](#) for recommended values for typical output voltages.

#### 9.2.1.2 Output and Feed-Forward Capacitors

The LMZ20502 is designed to work with low ESR ceramic capacitors. The **effective** value of these capacitors is defined as the actual capacitance under voltage bias and temperature. All ceramic capacitors have large voltage coefficients, in addition to normal tolerances and temperature coefficients. Under D.C. bias, the capacitance value drops considerably. Larger case sizes and/or higher voltage capacitors are better in this regard. To help mitigate these effects, multiple small capacitors can be used in parallel to bring the minimum **effective** capacitance up to the desired value. This can also ease the RMS current requirements on a single capacitor. Typically, 10 V, X5R, 0805 capacitors are adequate for the output, while 16-V caps may be used on the input. Some recommended component values are provided in [Table 2](#). Also, shown are the measured values of **effective** input and output capacitance for the given capacitor. If smaller values of output capacitance are used, C<sub>FF</sub> must be adjusted to give good phase margin. In any case, load transient response will be compromised with lower values of output capacitance. Values much lower than those found in [Table 2](#) should be avoided.

In practice, the output capacitor and C<sub>FF</sub>, are adjusted for the best transient response and highest loop phase margin. Load transient testing and Bode plots are the best way to validate any given design. Application report [SLVA289](#) should prove helpful when optimizing the feed-forward capacitor. Also, [SNVA364](#) details a simple method of creating a Bode plot with basic laboratory equipment. The values of C<sub>FF</sub> found in [Table 2](#) provide a good starting point.

A careful study of the temperature and bias voltage variation of any candidate ceramic capacitor should be made in order to ensure that the minimum values of **effective** capacitance are provided. The best way to obtain an optimum design is to use the Texas Instruments WEBENCH tool.

The maximum value of total output capacitance should be limited to between 100 μF and 200 μF. Large values of output capacitance can prevent the regulator from starting-up correctly and adversely affect the loop stability. If values in the range given above, or larger, are to be used, then a careful study of start-up at full load and loop stability must be performed.

### 9.2.1.3 Input Capacitors

The ceramic input capacitors provide a low impedance source to the regulator in addition to supplying ripple current and isolating switching noise from other circuits. An **effective** value of at least 14  $\mu\text{F}$  is normally sufficient for the input capacitor. If the main input capacitor(s) can not be placed close to the module, then a small 10 nF to 100 nF capacitor should be placed directly at the module, across the supply and ground pins.

Many times it is desirable to use an electrolytic capacitor on the input, in parallel with the ceramics. This is especially true if long leads/traces are used to connect the input supply to the regulator. The moderate ESR of this capacitor can help damp any ringing on the input supply caused by long power leads. This method can also help to reduce voltage spikes that may exceed the maximum input voltage rating of the LMZ20502. The use of this additional capacitor will also help with voltage dips caused by input supplies with unusually high impedance.

Most of the switching current passes through the input ceramic capacitor(s). The approximate RMS value of this current can be calculated with [Equation 2](#) and should be checked against the manufactures maximum ratings.

$$I_{\text{RMS}} \approx \frac{I_{\text{OUT}}}{2} \quad (2)$$

### 9.2.1.4 Maximum Ambient Temperature

As with any power conversion device, the LMZ20502 will dissipate internal power while operating. The effect of this power dissipation is to raise the internal temperature of the converter, above ambient. The internal die temperature is a function of the ambient temperature, the power loss and the effective thermal resistance  $R_{\theta\text{JA}}$  of the device and PCB combination. The maximum internal die temperature for the LMZ20502 is 125°C, thus establishing a limit on the maximum device power dissipation and therefore load current at high ambient temperatures. [Equation 3](#) shows the relationships between the important parameters.

$$I_{\text{OUT}} = \frac{(T_{\text{J}} - T_{\text{A}})}{R_{\theta\text{JA}}} \cdot \frac{\eta}{(1 - \eta)} \cdot \frac{1}{V_{\text{OUT}}} \quad (3)$$

It is easy to see that larger ambient temperatures and larger values of  $R_{\theta\text{JA}}$  will reduce the maximum available output current. As stated in [SPRA953](#), the values given in the [Thermal Information](#) table are not valid for design purposes and must not be used to estimate the thermal performance of the application. The values reported in that table were measured under a specific set of conditions that never obtain in an actual application. The effective  $R_{\theta\text{JA}}$  is a critical parameter and depends on many factors such as power dissipation, air temperature, PCB area, copper heatsink area, air flow, and adjacent component placement. The resources found in [表 3](#) can be used as a guide to estimate the  $R_{\theta\text{JA}}$  for a given application environment. A typical example of  $R_{\theta\text{JA}}$  versus copper board area is shown in [Figure 18](#). The copper area in this graph is that for each layer; the inner layers are 1 oz. (35 $\mu\text{m}$ ). An  $R_{\theta\text{JA}}$  of 44°C/W is the approximate value for the LMZ20502 evaluation board. The efficiency found in the equation,  $\eta$ , should be taken at the elevated ambient temperature. For the LMZ20502 the efficiency is about two to three percent lower at high temperatures. Therefore, a slightly lower value than the typical efficiency can be used in the calculation. In this way [Equation 3](#) can be used to estimate the maximum output current for a given ambient, or to estimate the maximum ambient for a given load current.

A typical curve of maximum load current vs. ambient temperature is shown in [Figure 19](#). This graph assumes a  $R_{\theta\text{JA}}$  of 44°C/W and an input voltage of 5 V.

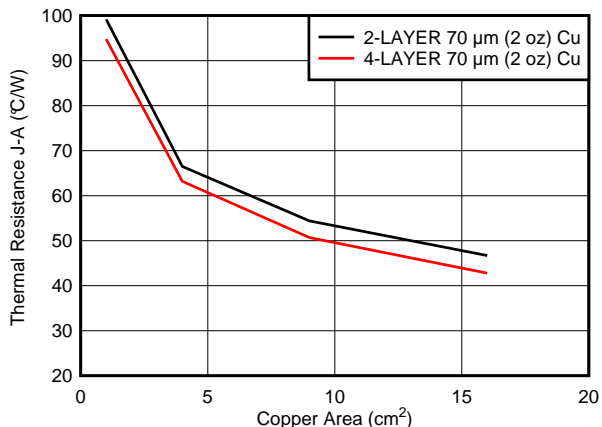

Figure 18.  $R_{\theta JA}$  versus Copper Board Area

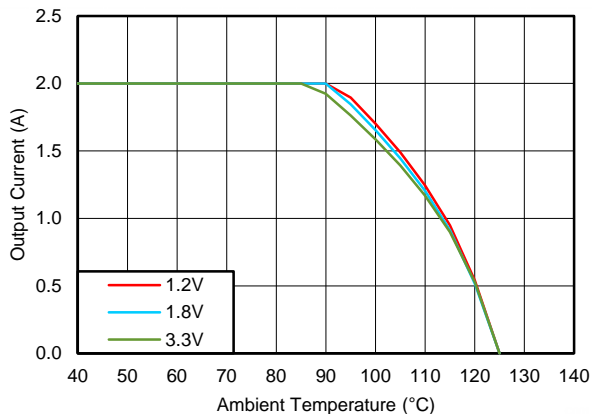

Figure 19. Maximum Output Current Vs. Ambient Temperature,  $R_{\theta JA} = 44^{\circ}\text{C/W}$ ,  $V_{IN} = 5\text{ V}$

### 9.2.1.5 Options

The circuit in Figure 17 highlights the use of the features of the LMZ20502. The PG output is open drain, and requires a pull-up resistor to a logic supply that is commensurate with the system logic voltage levels. If a reset function is not needed, the PG pin should be left open. The EN and MODE inputs are digital inputs, requiring only simple logic levels for proper operation. If the system does not need to control these features, the inputs should be connected to either VIN or GND, as appropriate. Please see [Feature Description](#) for details.

### 9.2.2 Application Curves

The following specifications apply to the circuit found in [Figure 16](#) or [Figure 17](#) with the appropriate modifications from [Table 2](#). **These parameters are not tested and represent typical performance only.** Unless otherwise stated the following conditions apply:  $T_A = 25^\circ\text{C}$ .

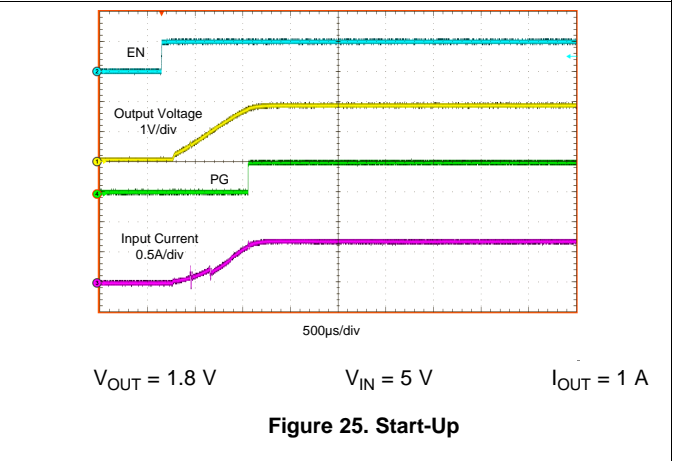
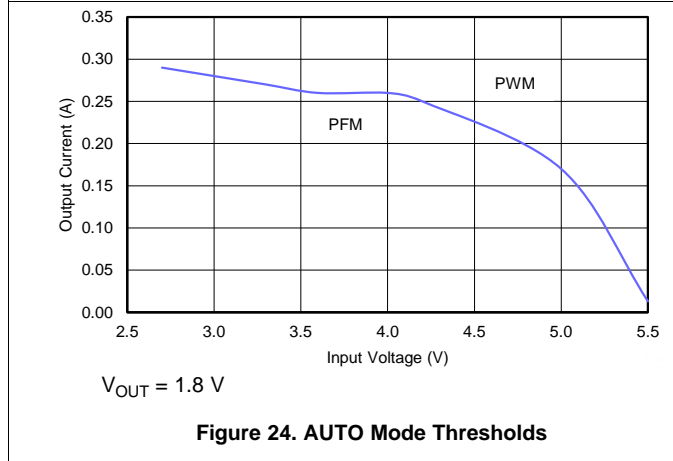
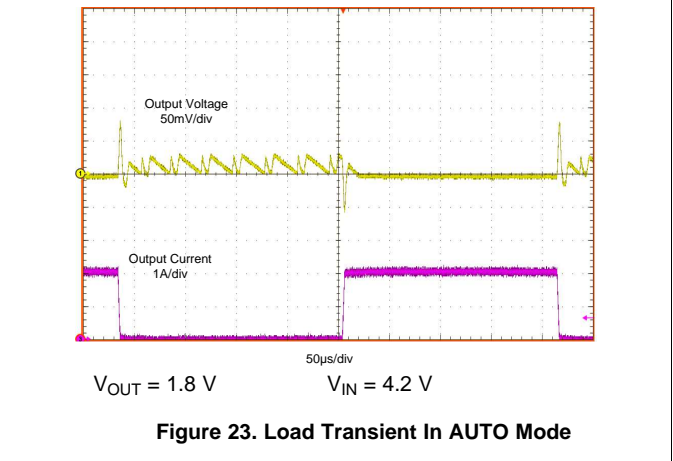
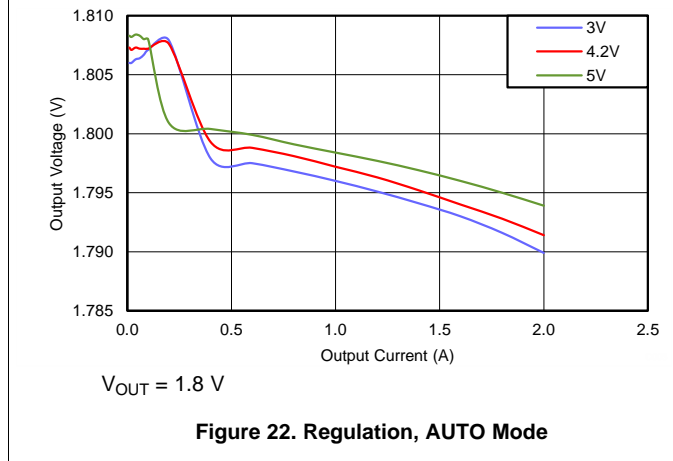
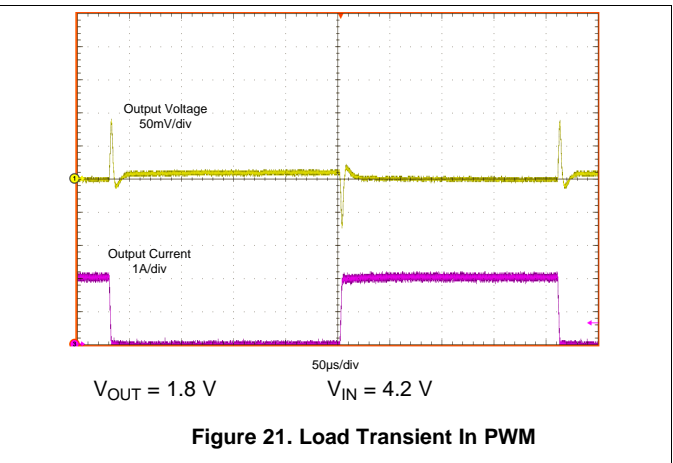
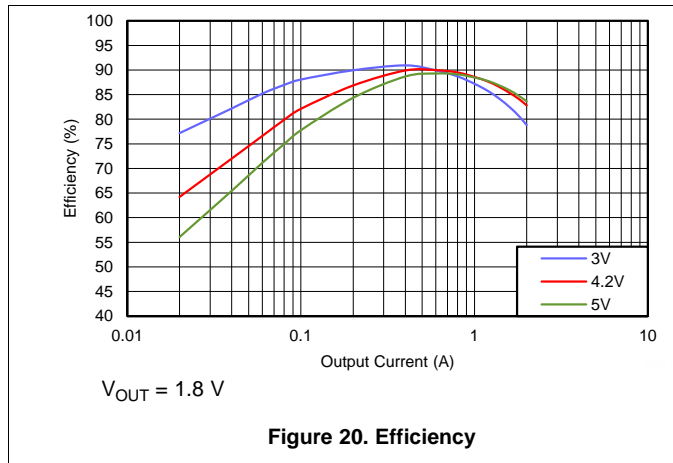

The following specifications apply to the circuit found in [Figure 16](#) or [Figure 17](#) with the appropriate modifications from [Table 2](#). These parameters are not tested and represent typical performance only. Unless otherwise stated the following conditions apply:  $T_A = 25^\circ\text{C}$ .

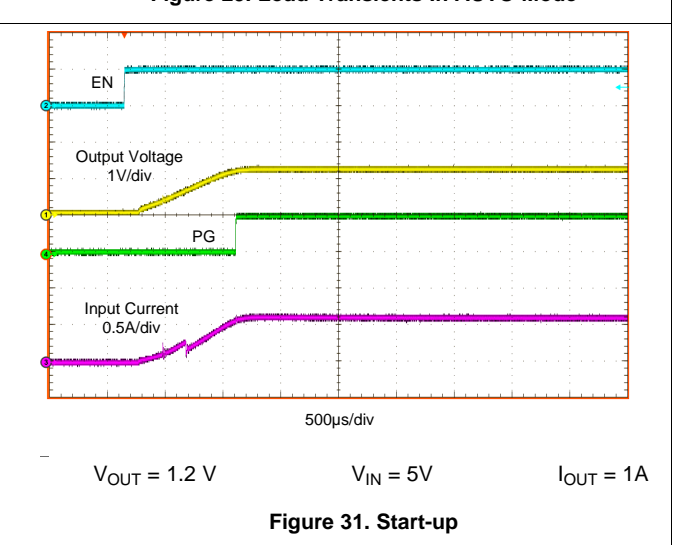
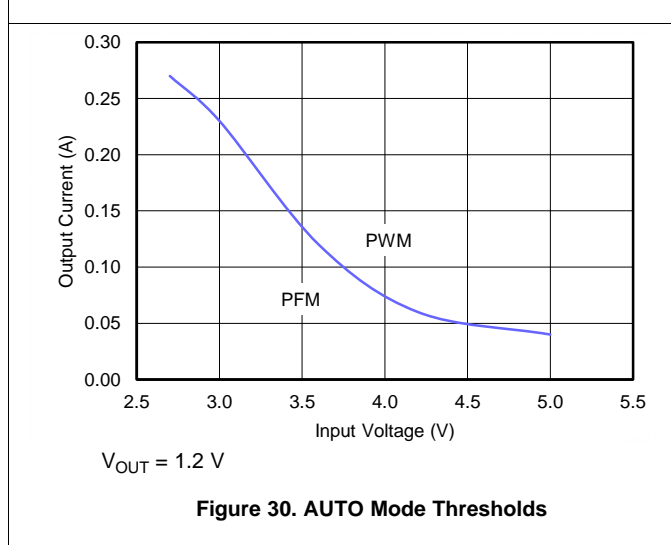
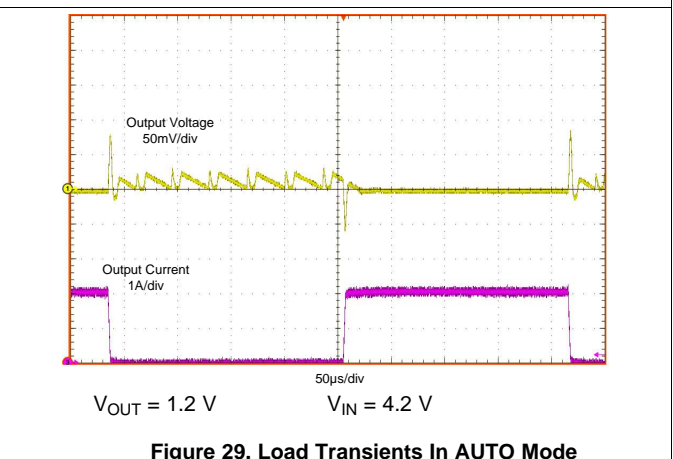
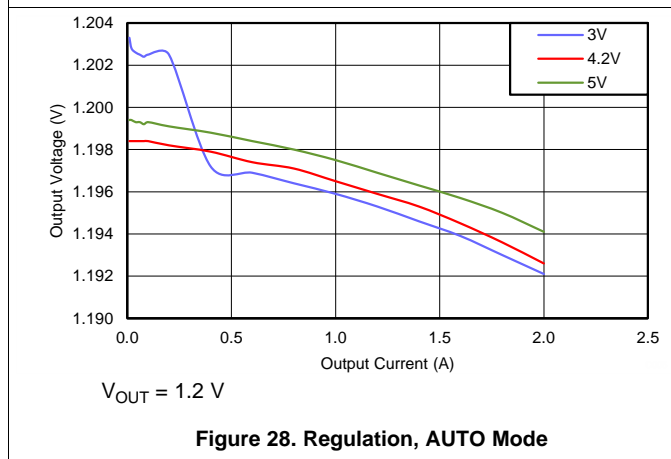
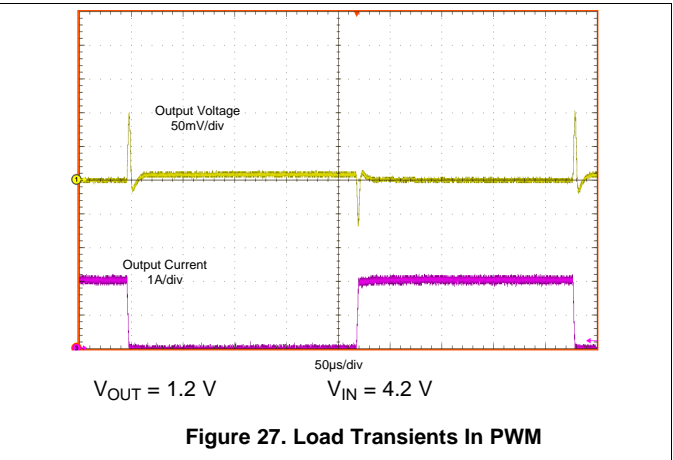
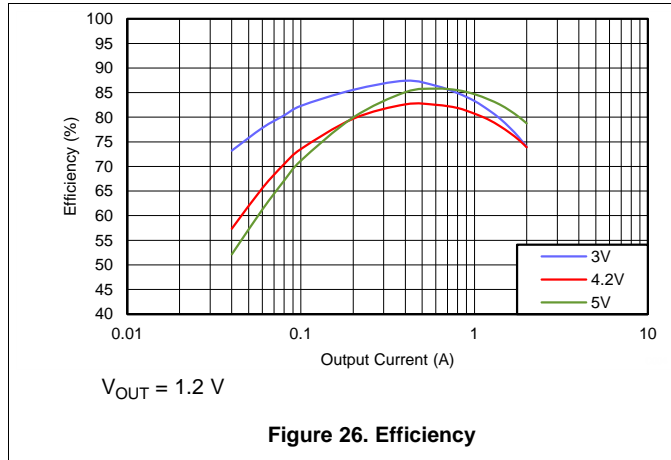

# LMZ20502

ZHCSD60B – JUNE 2012 – REVISED DECEMBER 2014

www.ti.com.cn

The following specifications apply to the circuit found in [Figure 16](#) or [Figure 17](#) with the appropriate modifications from [Table 2](#). **These parameters are not tested and represent typical performance only.** Unless otherwise stated the following conditions apply:  $T_A = 25^\circ\text{C}$ .

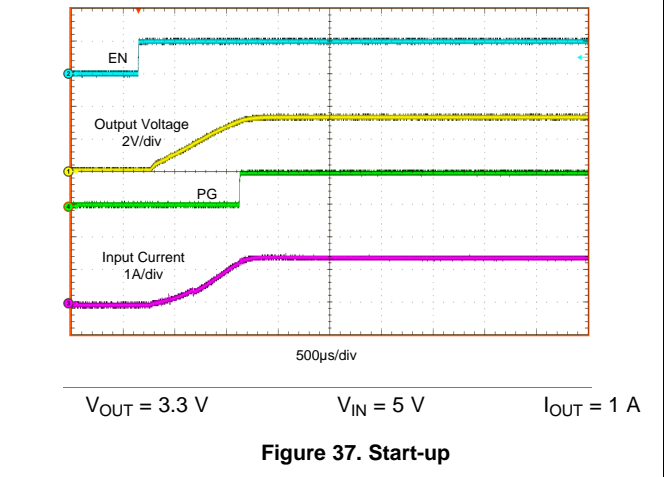
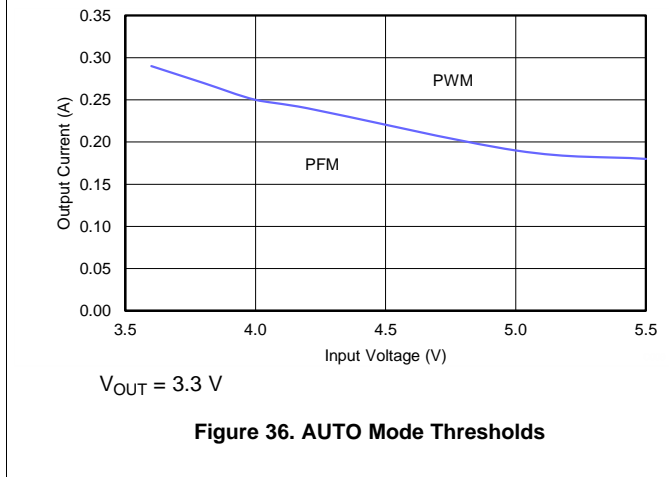
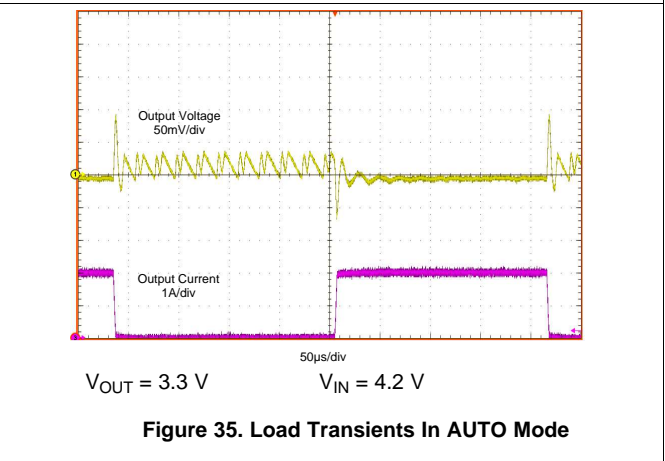
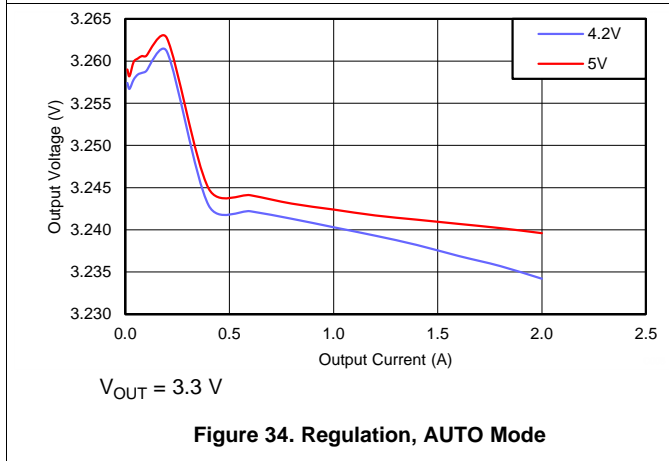
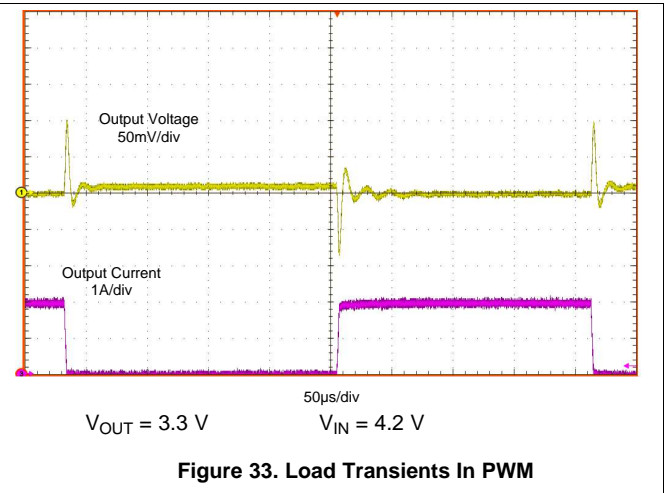
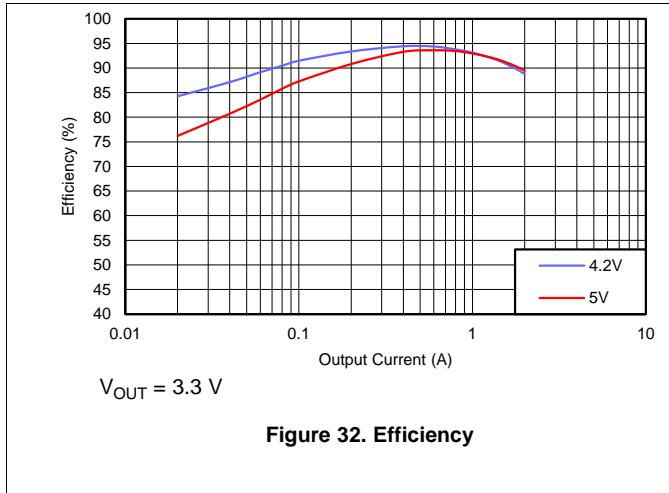

### 9.3 Do's and Don'ts

- **Don't:** Exceed the [Absolute Maximum Ratings](#).
- **Don't:** Exceed the [ESD Ratings](#).
- **Don't:** Exceed the [Recommended Operating Conditions](#).
- **Don't:** Allow the EN or MODE input to float.
- **Don't:** Allow the voltage on the EN or MODE input to exceed the voltage on the VIN pin.
- **Don't:** Allow the output voltage to exceed the input voltage.
- **Don't:** Use the thermal data given in the [Thermal Information](#) table to design your application.
- **Do:** Follow all of the guidelines and/or suggestions found in this data sheet, before committing your design to production. TI Application Engineers are ready to help critique your design and PCB layout to help make your project a success.
- **Do:** Refer to the helpful documents found in [表 3](#) and [表 4](#).

## 10 Power Supply Recommendations

The characteristics of the input supply must be compatible with the [Absolute Maximum Ratings](#) and [Recommended Operating Conditions](#) found in this data sheet. In addition, the input supply must be capable of delivering the required input current to the loaded regulator. The average input current can be estimated with [Equation 4](#)

$$I_{IN} = \frac{V_{OUT} \cdot I_{OUT}}{V_{IN} \cdot \eta} \quad (4)$$

If the regulator is connected to the input supply through long wires or PCB traces, special care is required to achieve good performance. The parasitic inductance and resistance of the input cables can have an adverse effect on the operation of the regulator. The parasitic inductance, in combination with the low ESR ceramic input capacitors, can form an under-damped resonant circuit. This circuit may cause over-voltage transients at the VIN pin, each time the input supply is cycled on and off. The parasitic resistance will cause the voltage at the VIN pin to dip when the load on the regulator is switched on, or exhibits a transient. If the regulator is operating close to the minimum input voltage, this dip may cause the device to shutdown and/or reset. The best way to solve these kinds of issues is to reduce the distance from the input supply to the regulator and/or use an aluminum or tantalum input capacitor in parallel with the ceramics. The moderate ESR of these types of capacitors will help to damp the input resonant circuit and reduce any voltage overshoots. A value in the range of 20  $\mu$ F to 100  $\mu$ F is usually sufficient to provide input damping and help to hold the input voltage steady during large load transients.

Sometimes, for other system considerations, an input filter is used in front of the regulator module. This can lead to instability, as well as some of the effects mentioned above, unless it is designed carefully. The following user guide provides helpful suggestions when designing an input filter for any switching regulator: [SNVA489](#).

In some cases a Transient Voltage Suppressor (TVS) is used on the input of regulators. One class of this device has a "snap-back" V-I characteristic (thyristor type). The use of a device with this type of characteristic is not recommended. When the TVS "fires", the clamping voltage drops to a very low value. If this holding voltage is less than the output voltage of the regulator, the output capacitors will be discharged through the regulator back to the input. This uncontrolled current flow could damage the regulator.

## 11 Layout

### 11.1 Layout Guidelines

The PCB layout of any DC-DC converter is critical to the optimal performance of the design. Bad PCB layout can disrupt the operation of an otherwise good schematic design. Even if the converter regulates correctly, bad PCB layout can mean the difference between a robust design and one that cannot be mass produced. Furthermore, the EMI performance of the regulator is dependent on the PCB layout, to a great extent. In a buck converter, the most critical PCB feature is the loop formed by the input capacitor and the module ground, as shown in Figure 38. This loop carries fast transient currents that can cause large transient voltages when reacting with the trace inductance. These unwanted transient voltages will disrupt the proper operation of the converter. Because of this, the traces in this loop should be wide and short, and the loop area as small as possible to reduce the parasitic inductance. Figure 39 shows a recommended layout for the critical components of the LMZ20502; the top side metal is shown in red. This PCB layout is a good guide for any specific application. The following important guidelines should also be followed:

1. **Place the input capacitor  $C_{IN}$  as close as possible to the VIN and GND terminals.** VIN (pin 8) and GND (pin 6) are on the same side of the module, simplifying the input capacitor placement.
2. **Place the feedback divider as close as possible to the FB pin on the module.** The divider and  $C_{FF}$  should be close to the module, while the length of the trace from VOUT to the divider can be somewhat longer. However, this latter trace should not be routed near any noise sources that can capacitively couple to the FB input.
3. **Connect the EP pad to the GND plane.** This pad acts as a heat-sink connection and a ground connection for the module. It must be solidly connected to a ground plane. The integrity of this connection has a direct bearing on the effective  $R_{\theta JA}$ .
4. **Provide enough PCB area for proper heat-sinking.** As stated in the *Maximum Ambient Temperature* section, enough copper area must be used to provide a low  $R_{\theta JA}$ , commensurate with the maximum load current and ambient temperature. The top and bottom PCB layers should be made with two ounce copper; and no less than one ounce.
5. **The resources in 表 4 provide additional important guidelines**

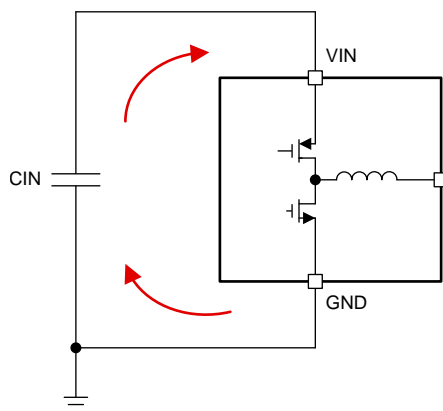

Figure 38. Current Loops With Fast Transient Currents



## 11.2 Layout Example

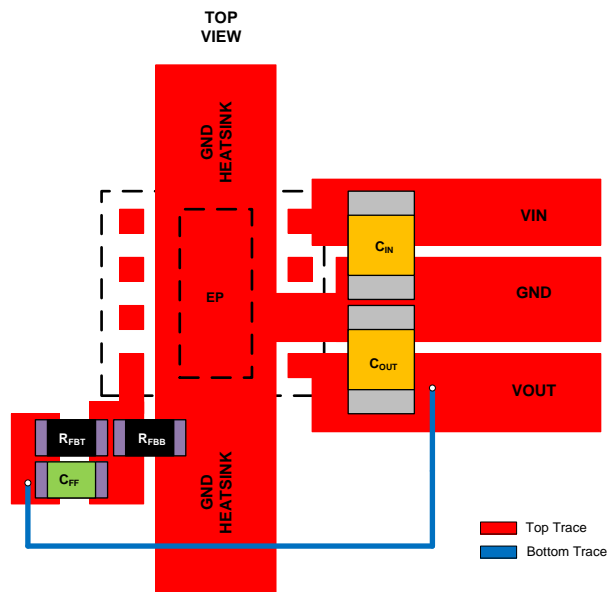

Figure 39. Example PCB Layout

## 11.3 Soldering Information

Proper operation of the LMZ20502 requires that it be correctly soldered to the PCB. This is especially true regarding the EP. This pad acts as a quiet ground reference for the device and a heatsink connection. Use the following recommendations when utilizing machine placement of the device:

- Dimension of area for pick-up: 2 mm x 2.5 mm.
- Use a nozzle size of less than 1.3 mm in diameter, so that the head does not touch the outer area of the package.
- Use a soft tip pick-and-place head.
- Add 0.05 mm to the component thickness so that the device will be released 0.05 mm into the solder paste without putting pressure or splashing the solder paste.
- Slow the pick arm when picking the part from the tape and reel carrier and when depositing the device on the board.
- If the machine releases the component by force, use the minimum force and no more than 3 N.
- For PCBs with surface mount components on both sides, it is suggested to put the LMZ20502 on the top side. In case the application requires bottom side placement, a re-flow fixture may be required to protect the module during the second reflow.

In addition, please follow the important guidelines found in: [SNOA401](#). The curves in [Figure 40](#) and [Figure 41](#) show typical soldering temperature profiles.

**Soldering Information (continued)**

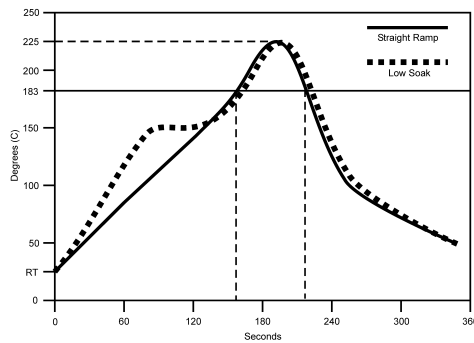

**Figure 40. Typical Re-flow Profile Eutectic (63sn/37pb) Solder Paste**

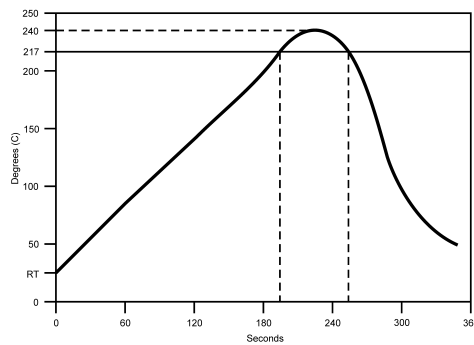

**Figure 41. Typical Re-flow Profile Lead-Free (Sca305 Or Sac405) Solder Paste**

## 12 器件和文档支持

### 12.1 器件支持

#### 12.1.1 第三方产品免责声明

TI 发布的与第三方产品或服务有关的信息，不能构成与此类产品或服务或保修的适用性有关的认可，不能构成此类产品或服务单独或与任何 TI 产品或服务一起的表示或认可。

#### 12.1.2 相关链接

有关德州仪器 (TI) Simple Switcher 产品线的更多信息，请访问 Simple Switcher 网页：[Simple Switcher](#)。

表 3. 用于估算  $R_{\theta JA}$  的资源

标题	链接
AN-2020 《富于洞见的热设计》	<a href="#">SNVA419</a>
AN-2026 《PCB 设计对 SIMPLE SWITCHER 电源模块散热性能的影响》	<a href="#">SNVA424</a>
AN-1520 《外露封装实现最佳热敏电阻特性的电路板布线指南》	<a href="#">SNVA183</a>
AN-1187 《无引线框架封装 (LLP)》	<a href="#">SNOA401</a>
SPRA953B 《半导体和 IC 封装热指标》	<a href="#">SPRA953</a>

表 4. PCB 布局布线资源

标题	链接
AN-1149 《开关电源布局指南》	<a href="#">SNVA021</a>
AN-1229 《SIMPLE SWITCHER PCB 布局指南》	<a href="#">SNVA054</a>
《构建电源 - 布局注意事项》	<a href="#">SLUP230</a>

### 12.2 商标

WebTherm is a trademark of Texas Instruments.

SIMPLE SWITCHER, WEBENCH are registered trademarks of Texas Instruments.

All other trademarks are the property of their respective owners.

### 12.3 静电放电警告



这些装置包含有限的内置 ESD 保护。存储或装卸时，应将导线一起截短或将装置放置于导电泡棉中，以防止 MOS 门极遭受静电损伤。

### 12.4 术语表

[SLYZ022](#) — TI 术语表。

这份术语表列出并解释术语、首字母缩略词和定义。

## 13 机械封装和可订购信息

以下页中包括机械封装和可订购信息。 这些信息是针对指定器件可提供的最新数据。 这些数据会在无通知且不对本文档进行修订的情况下发生改变。 欲获得该数据表的浏览器版本，请查阅左侧的导航栏。

## 重要声明

德州仪器(TI)及其下属子公司有权根据 JESD46 最新标准,对所提供的产品和服务进行更正、修改、增强、改进或其它更改,并有权根据 JESD48 最新标准中止提供任何产品和服务。客户在下订单前应获取最新的相关信息,并验证这些信息是否完整且是最新的。所有产品的销售都遵循在订单确认时所提供的TI 销售条款与条件。

TI 保证其所销售的组件的性能符合产品销售时 TI 半导体产品销售条件与条款的适用规范。仅在 TI 保证的范围内,且 TI 认为有必要时才会使用测试或其它质量控制技术。除非适用法律做出了硬性规定,否则没有必要对每种组件的所有参数进行测试。

TI 对应用帮助或客户产品设计不承担任何义务。客户应对其使用 TI 组件的产品和应用自行负责。为尽量减小与客户产品和应用相关的风险,客户应提供充分的设计与操作安全措施。

TI 不对任何 TI 专利权、版权、屏蔽作品权或其它与使用了 TI 组件或服务的组合设备、机器或流程相关的 TI 知识产权中授予的直接或隐含权限作出任何保证或解释。TI 所发布的与第三方产品或服务有关的信息,不能构成从 TI 获得使用这些产品或服务的许可、授权、或认可。使用此类信息可能需要获得第三方的专利权或其它知识产权方面的许可,或是 TI 的专利权或其它知识产权方面的许可。

对于 TI 的产品手册或数据表中 TI 信息的重要部分,仅在没有对内容进行任何篡改且带有相关授权、条件、限制和声明的情况下才允许进行复制。TI 对此类篡改过的文件不承担任何责任或义务。复制第三方的信息可能需要服从额外的限制条件。

在转售 TI 组件或服务时,如果对该组件或服务参数的陈述与 TI 标明的参数相比存在差异或虚假成分,则会失去相关 TI 组件或服务的所有明示或暗示授权,且这是不正当的、欺诈性商业行为。TI 对任何此类虚假陈述均不承担任何责任或义务。

客户认可并同意,尽管任何应用相关信息或支持仍可能由 TI 提供,但他们将独立负责满足与其产品及其在应用中使用的 TI 产品相关的所有法律、法规和安全相关要求。客户声明并同意,他们具备制定与实施安全措施所需的全部专业技术和知识,可预见故障的危险后果、监测故障及其后果、降低有可能造成人身伤害的故障的发生机率并采取适当的补救措施。客户将全额赔偿因在此类安全关键应用中使用任何 TI 组件而对 TI 及其代理造成的任何损失。

在某些场合中,为了推进安全相关应用有可能对 TI 组件进行特别的促销。TI 的目标是利用此类组件帮助客户设计和创立其特有的可满足适用的功能安全性标准和要求的终端产品解决方案。尽管如此,此类组件仍然服从这些条款。

TI 组件未获得用于 FDA Class III (或类似的生命攸关医疗设备)的授权许可,除非各方授权官员已经达成了专门管控此类使用的特别协议。



只有那些 TI 特别注明属于军用等级或“增强型塑料”的 TI 组件才是设计或专门用于军事/航空应用或环境的。购买者认可并同意,对并非指定面向军事或航空航天用途的 TI 组件进行军事或航空航天方面的应用,其风险由客户单独承担,并且由客户独立负责满足与此类使用相关的所有法律和法规要求。

TI 已明确指定符合 ISO/TS16949 要求的产品,这些产品主要用于汽车。在任何情况下,因使用非指定产品而无法达到 ISO/TS16949 要求, TI 不承担任何责任。

	产品		应用
数字音频	<a href="http://www.ti.com.cn/audio">www.ti.com.cn/audio</a>	通信与电信	<a href="http://www.ti.com.cn/telecom">www.ti.com.cn/telecom</a>
放大器和线性器件	<a href="http://www.ti.com.cn/amplifiers">www.ti.com.cn/amplifiers</a>	计算机及周边	<a href="http://www.ti.com.cn/computer">www.ti.com.cn/computer</a>
数据转换器	<a href="http://www.ti.com.cn/dataconverters">www.ti.com.cn/dataconverters</a>	消费电子	<a href="http://www.ti.com.cn/consumer-apps">www.ti.com.cn/consumer-apps</a>
DLP® 产品	<a href="http://www.dlp.com">www.dlp.com</a>	能源	<a href="http://www.ti.com.cn/energy">www.ti.com.cn/energy</a>
DSP - 数字信号处理器	<a href="http://www.ti.com.cn/dsp">www.ti.com.cn/dsp</a>	工业应用	<a href="http://www.ti.com.cn/industrial">www.ti.com.cn/industrial</a>
时钟和计时器	<a href="http://www.ti.com.cn/clockandtimers">www.ti.com.cn/clockandtimers</a>	医疗电子	<a href="http://www.ti.com.cn/medical">www.ti.com.cn/medical</a>
接口	<a href="http://www.ti.com.cn/interface">www.ti.com.cn/interface</a>	安防应用	<a href="http://www.ti.com.cn/security">www.ti.com.cn/security</a>
逻辑	<a href="http://www.ti.com.cn/logic">www.ti.com.cn/logic</a>	汽车电子	<a href="http://www.ti.com.cn/automotive">www.ti.com.cn/automotive</a>
电源管理	<a href="http://www.ti.com.cn/power">www.ti.com.cn/power</a>	视频和影像	<a href="http://www.ti.com.cn/video">www.ti.com.cn/video</a>
微控制器 (MCU)	<a href="http://www.ti.com.cn/microcontrollers">www.ti.com.cn/microcontrollers</a>		
RFID 系统	<a href="http://www.ti.com.cn/rfidsys">www.ti.com.cn/rfidsys</a>		
OMAP应用处理器	<a href="http://www.ti.com.cn/omap">www.ti.com.cn/omap</a>		
无线连通性	<a href="http://www.ti.com.cn/wirelessconnectivity">www.ti.com.cn/wirelessconnectivity</a>	德州仪器在线技术支持社区	<a href="http://www.deyisupport.com">www.deyisupport.com</a>

邮寄地址: 上海市浦东新区世纪大道1568号, 中建大厦32楼邮政编码: 200122  
Copyright © 2014, 德州仪器半导体技术(上海)有限公司

**PACKAGING INFORMATION**

Orderable Device	Status (1)	Package Type	Package Drawing	Pins	Package Qty	Eco Plan (2)	Lead/Ball Finish (6)	MSL Peak Temp (3)	Op Temp (°C)	Device Marking (4/5)	Samples
LMZ20502SILR	ACTIVE	uSiP	SIL	8	3000	Green (RoHS & no Sb/Br)	Call TI	Level-3-260C-168 HR	-40 to 125	TXN5201EC EC 7543 0502 0502 7543 EC	
LMZ20502SILT	ACTIVE	uSiP	SIL	8	250	Green (RoHS & no Sb/Br)	Call TI	Level-3-260C-168 HR	-40 to 125	TXN5201EC EC 7543 0502 0502 7543 EC	

(1) The marketing status values are defined as follows:

**ACTIVE:** Product device recommended for new designs.

**LIFEBUY:** TI has announced that the device will be discontinued, and a lifetime-buy period is in effect.

**NRND:** Not recommended for new designs. Device is in production to support existing customers, but TI does not recommend using this part in a new design.

**PREVIEW:** Device has been announced but is not in production. Samples may or may not be available.

**OBSOLETE:** TI has discontinued the production of the device.

(2) Eco Plan - The planned eco-friendly classification: Pb-Free (RoHS), Pb-Free (RoHS Exempt), or Green (RoHS & no Sb/Br) - please check <http://www.ti.com/productcontent> for the latest availability information and additional product content details.

**TBD:** The Pb-Free/Green conversion plan has not been defined.

**Pb-Free (RoHS):** TI's terms "Lead-Free" or "Pb-Free" mean semiconductor products that are compatible with the current RoHS requirements for all 6 substances, including the requirement that lead not exceed 0.1% by weight in homogeneous materials. Where designed to be soldered at high temperatures, TI Pb-Free products are suitable for use in specified lead-free processes.

**Pb-Free (RoHS Exempt):** This component has a RoHS exemption for either 1) lead-based flip-chip solder bumps used between the die and package, or 2) lead-based die adhesive used between the die and leadframe. The component is otherwise considered Pb-Free (RoHS compatible) as defined above.

**Green (RoHS & no Sb/Br):** TI defines "Green" to mean Pb-Free (RoHS compatible), and free of Bromine (Br) and Antimony (Sb) based flame retardants (Br or Sb do not exceed 0.1% by weight in homogeneous material)

(3) MSL, Peak Temp. - The Moisture Sensitivity Level rating according to the JEDEC industry standard classifications, and peak solder temperature.

(4) There may be additional marking, which relates to the logo, the lot trace code information, or the environmental category on the device.

(5) Multiple Device Markings will be inside parentheses. Only one Device Marking contained in parentheses and separated by a "~" will appear on a device. If a line is indented then it is a continuation of the previous line and the two combined represent the entire Device Marking for that device.

(6) Lead/Ball Finish - Orderable Devices may have multiple material finish options. Finish options are separated by a vertical ruled line. Lead/Ball Finish values may wrap to two lines if the finish value exceeds the maximum column width.

**Important Information and Disclaimer:** The information provided on this page represents TI's knowledge and belief as of the date that it is provided. TI bases its knowledge and belief on information provided by third parties, and makes no representation or warranty as to the accuracy of such information. Efforts are underway to better integrate information from third parties. TI has taken and continues to take reasonable steps to provide representative and accurate information but may not have conducted destructive testing or chemical analysis on incoming materials and chemicals. TI and TI suppliers consider certain information to be proprietary, and thus CAS numbers and other limited information may not be available for release.

In no event shall TI's liability arising out of such information exceed the total purchase price of the TI part(s) at issue in this document sold by TI to Customer on an annual basis.

## 重要声明

德州仪器 (TI) 公司有权按照最新发布的 JESD46 对其半导体产品和服务进行纠正、增强、改进和其他修改，并不再按最新发布的 JESD48 提供任何产品和服务。买方在下订单前应获取最新的相关信息，并验证这些信息是否完整且是最新的。

TI 公布的半导体产品销售条款 (<http://www.ti.com/sc/docs/stdterms.htm>) 适用于 TI 已认证和批准上市的已封装集成电路产品的销售。另有其他条款可能适用于其他类型 TI 产品及服务的使用或销售。

复制 TI 数据表上 TI 信息的重要部分时，不得变更该等信息，且必须随附所有相关保证、条件、限制和通知，否则不得复制。TI 对该等复制文件不承担任何责任。第三方信息可能受到其它限制条件的制约。在转售 TI 产品或服务时，如果存在对产品或服务参数的虚假陈述，则会失去相关 TI 产品或服务的明示或暗示保证，且构成不公平的、欺诈性商业行为。TI 对此类虚假陈述不承担任何责任。

买方和在系统中整合 TI 产品的其他开发人员（总称“设计人员”）理解并同意，设计人员在设计应用时应自行实施独立的分析、评价和判断，且应全权负责并确保应用的安全性，及设计人员的应用（包括应用中使用的 TI 产品）应符合所有适用的法律法规及其他相关要求。设计人员就自己设计的应用声明，其具备制订和实施下列保障措施所需的一切必要专业知识，能够 (1) 预见故障的危险后果，(2) 监视故障及其后果，以及 (3) 降低可能导致危险的故障几率并采取适当措施。设计人员同意，在使用或分发包含 TI 产品的任何应用前，将彻底测试该等应用和该等应用中所用 TI 产品的功能。

TI 提供技术、应用或其他设计建议、质量特点、可靠性数据或其他服务或信息，包括但不限于与评估模块有关的参考设计和材料（总称“TI 资源”），旨在帮助设计人员开发整合了 TI 产品的应用，如果设计人员（个人，或如果是代表公司，则为设计人员的公司）以任何方式下载、访问或使用任何特定的 TI 资源，即表示其同意仅为该等目标，按照本通知的条款使用任何特定 TI 资源。

TI 所提供的 TI 资源，并未扩大或以其他方式修改 TI 对 TI 产品的公开适用的质保及质保免责声明；也未导致 TI 承担任何额外的义务或责任。TI 有权对其 TI 资源进行纠正、增强、改进和其他修改。除特定 TI 资源的公开文档中明确列出的测试外，TI 未进行任何其他测试。

设计人员只有在开发包含该等 TI 资源所列 TI 产品的应用时，才被授权使用、复制和修改任何相关 TI 资源。但并未依据禁止反言原则或其他法律授予您任何 TI 知识产权的任何其他明示或默示的许可，也未授予您 TI 或第三方的任何技术或知识产权的许可，该等许可包括但不限于任何专利权、版权、屏蔽作品权或与美国 TI 产品或服务的任何整合、机器制作、流程相关的其他知识产权。涉及或参考了第三方产品或服务的信息不构成使用此类产品或服务的许可或与其相关的保证或认可。使用 TI 资源可能需要您向第三方获得对该等第三方专利或其他知识产权的许可。

TI 资源系“按原样”提供。TI 兹免除对资源及其使用作出所有其他明确或默示的保证或陈述，包括但不限于对准确性或完整性、产权保证、无屡发故障保证，以及适销性、适合特定用途和不侵犯任何第三方知识产权的任何默认保证。TI 不负责任何申索，包括但不限于因组合产品所致或与之有关的申索，也不为或对设计人员进行辩护或赔偿，即使该等产品组合已列于 TI 资源或其他地方。对因 TI 资源或其使用引起或与之有关的任何实际的、直接的、特殊的、附带的、间接的、惩罚性的、偶发的、从属或惩戒性损害赔偿，不管 TI 是否获悉可能会产生上述损害赔偿，TI 概不负责。

除 TI 已明确指出特定产品已达到特定行业标准（例如 ISO/TS 16949 和 ISO 26262）的要求外，TI 不对未达到任何该等行业标准要求而承担任何责任。

如果 TI 明确宣称产品有助于功能安全或符合行业功能安全标准，则该等产品旨在帮助客户设计和创作自己的符合相关功能安全标准和要求的的应用。在应用内使用产品的行为本身不会配有安全特性。设计人员必须确保遵守适用于其应用的相关安全要求和标准。设计人员不可将任何 TI 产品用于关乎性命的医疗设备，除非已由各方获得授权的管理人员签署专门的合同对此类应用专门作出规定。关乎性命的医疗设备是指出现故障会导致严重身体伤害或死亡的医疗设备（例如生命保障设备、心脏起搏器、心脏除颤器、人工心脏泵、神经刺激器以及植入设备）。此类设备包括但不限于，美国食品药品监督管理局认定为 III 类设备的设备，以及在美国以外的其他国家或地区认定为同等类别设备的所有医疗设备。

TI 可能明确指定某些产品具备某些特定资格（例如 Q100、军用级或增强型产品）。设计人员同意，其具备一切必要专业知识，可以为自己的应用选择适合的产品，并且正确选择产品的风险由设计人员承担。设计人员单方面负责遵守与该等选择有关的所有法律或监管要求。

设计人员同意向 TI 及其代表全额赔偿因其不遵守本通知条款和条件而引起的任何损害、费用、损失和/或责任。

邮寄地址：上海市浦东新区世纪大道 1568 号中建大厦 32 楼，邮政编码：200122  
Copyright © 2017 德州仪器半导体技术（上海）有限公司