

# BZT52S Series

## List

List..... 1

Package outline..... 2

Features..... 2

Mechanical data..... 2

Maximum ratings ..... 2

Electrical characteristics..... 3

Rating and characteristic curves..... 4~5

Pinning information..... 6

Suggested solder pad layout..... 6

Packing information..... 7

Reel packing..... 8

Suggested thermal profiles for soldering processes..... 8

High reliability test capabilities..... 9

# BZT52S Series

## 200mW Surface Mount Zener Diodes - 2.0V-75V

### Features

- Silicon epitaxial planar chip structure.
- Wide zener reverse voltage range 2.0V to 75V.
- Small package size for high density applications.
- Ideally suited for automated assembly processes.
- Pb-free package is available
- We declare that the material of product compliance with RoHS requirements.
- Suffix "-H" indicates Halogen-free part, ex. BZT52C2V0S-H.

### Mechanical data

- Epoxy:UL94-V0 rated flame retardant
- Case : Molded plastic, SOD-323F
- Terminals : Solder plated, solderable per MIL-STD-750, Method 2026
- Polarity : Indicated by cathode band
- Mounting Position : Any
- Weight : Approximated 0.005 gram

### Package outline

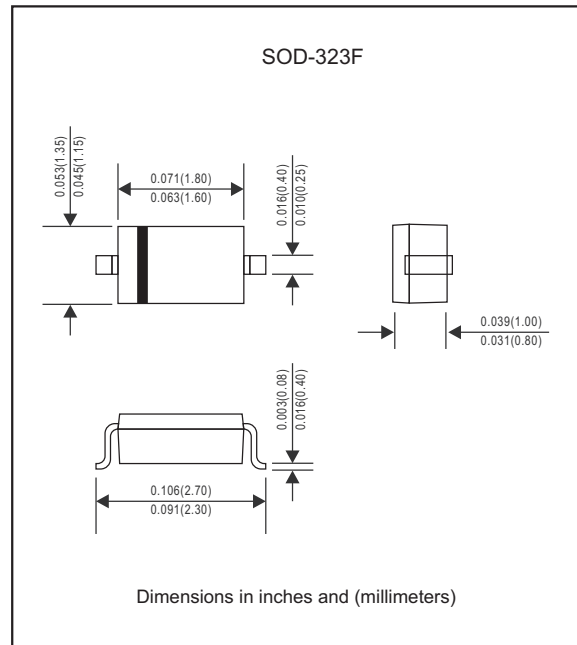

### Maximum ratings (at $T_A=25^\circ\text{C}$ unless otherwise noted)

PARAMETER	CONDITIONS	Symbol	MIN.	TYP.	MAX.	UNIT
Forward voltage	$I_F = 10 \text{ mA}$	$V_F$			0.9	V
Power dissipation	$T_A = 25^\circ\text{C}$ (note 1)	$P_D$			200	mW
Thermal resistance	Junction to ambient (note 1)	$R_{\theta JA}$		625		$^\circ\text{C}/\text{W}$
	Junction to case (note 1)	$R_{\theta JC}$		350		$^\circ\text{C}/\text{W}$
Operating junction temperature range		$T_J$	-55		+150	$^\circ\text{C}$
Storage temperature range		$T_{STG}$	-55		+150	$^\circ\text{C}$

Note 1: Mounted on FR-4 minimum pad

## BZT52S Series

Electrical characteristics (at  $T_A=25^{\circ}\text{C}$  unless otherwise noted)

Part No.	Marking code	Zener voltage			Test current	Zener Impedance			Leakage current		$\theta V_z$ @I <sub>ZT</sub>		C <sub>J</sub>
		V <sub>Z</sub> @ I <sub>ZT</sub>			I <sub>ZT</sub>	Z <sub>ZT</sub> @ I <sub>ZT</sub>	Z <sub>ZK</sub> @ I <sub>ZK</sub>	I <sub>ZK</sub>	I <sub>R</sub>	V <sub>R</sub>	mV/k	mV/k	@V <sub>R</sub> =0V f=1MHz
		Min.(V)	Nom.(V)	Max.(V)	mA	( $\Omega$ )Max	( $\Omega$ )Max	mA	( $\mu\text{A}$ )Max	Volts	Min.	Max.	(pF)Typ.
BZT52C2V0S	WY	1.91	2.0	2.09	5	100	600	1.0	150.0	1.0	-3.5	0	450
BZT52C2V4S	00	2.2	2.4	2.6	5	100	1000	0.5	50.0	1.0	-3.5	0	450
BZT52C2V7S	01	2.5	2.7	2.9	5	100	1000	0.5	20.0	1.0	-3.5	0	450
BZT52C3V0S	02	2.8	3.0	3.2	5	100	1000	0.5	10.0	1.0	-3.5	0	450
BZT52C3V3S	05	3.1	3.3	3.5	5	95	1000	0.5	5.0	1.0	-3.5	0	450
BZT52C3V6S	06	3.4	3.6	3.8	5	90	1000	0.5	5.0	1.0	-3.5	0	450
BZT52C3V9S	07	3.7	3.9	4.1	5	90	1000	0.5	3.0	1.0	-3.5	-2.5	450
BZT52C4V3S	08	4.0	4.3	4.6	5	90	1000	0.5	3.0	1.0	-3.5	0	450
BZT52C4V7S	09	4.4	4.7	5.0	5	80	800	0.5	3.0	2.0	-3.5	0.2	260
BZT52C5V1S	0A	4.8	5.1	5.4	5	60	800	0.5	2.0	2.0	-2.7	1.2	225
BZT52C5V6S	0C	5.2	5.6	6.0	5	40	700	0.5	1.0	2.0	-2.0	2.5	200
BZT52C6V2S	0E	5.8	6.2	6.6	5	10	100	0.5	3.0	4.0	0.4	3.7	185
BZT52C6V8S	0F	6.4	6.8	7.2	5	15	160	0.5	2.0	4.0	1.2	4.5	155
BZT52C7V5S	0G	7.0	7.5	7.9	5	15	160	0.5	1.0	5.0	2.5	5.3	140
BZT52C8V2S	0H	7.7	8.2	8.7	5	15	160	0.5	0.7	5.0	3.2	6.2	135
BZT52C9V1S	0K	8.5	9.1	9.6	5	15	160	0.5	0.2	7.0	3.8	7.0	130
BZT52C10S	0L	9.4	10	10.6	5	20	160	0.5	0.1	8.0	4.5	8.0	130
BZT52C11S	0M	10.4	11	11.6	5	20	160	0.5	0.1	8.0	5.4	9.0	130
BZT52C12S	0N	11.4	12	12.7	5	25	80	0.5	0.1	8.0	6.0	10	130
BZT52C13S	0P	12.4	13	14.1	5	30	80	0.5	0.1	8.0	7.0	11	120
BZT52C15S	0T	14.3	15	15.8	5	30	400	0.5	0.05	10.5	9.2	13	110
BZT52C16S	0U	15.3	16	17.1	5	40	400	0.5	0.05	11.2	10.4	14	105
BZT52C18S	0W	16.8	18	19.1	5	45	400	0.5	0.05	12.6	12.4	16	100
BZT52C20S	0Z	18.8	20	21.2	5	55	500	0.5	0.05	14.0	14.4	18	85
BZT52C22S	10	20.8	22	23.3	5	55	500	0.5	0.05	15.4	16.4	20	85
BZT52C24S	11	22.8	24	25.6	5	70	120	0.5	0.05	16.8	18.4	22	80
BZT52C27S	12	25.1	27	28.9	2	80	300	0.5	0.05	18.9	21.4	25.3	70
BZT52C30S	14	28	30	32	2	80	300	0.5	0.05	21.0	24.4	29.4	70
BZT52C33S	18	31	33	35	2	80	300	0.5	0.05	23.2	27.4	33.4	70
BZT52C36S	19	34	36	38	2	90	500	0.5	0.05	25.2	30.4	37.4	70
BZT52C39S	20	37	39	41	2	130	500	0.5	0.05	27.3	33.4	41.2	45
BZT52C43S	21	40	43	46	2	150	500	0.5	0.05	30.1	37.6	46.6	40
BZT52C47S	1A	44	47	50	2	170	500	0.5	0.05	32.9	42.0	51.8	40
BZT52C51S	1C	48	51	54	2	180	500	0.5	0.05	35.7	46.6	57.2	40
BZT52C56S	1D	52	56	60	2	200	500	0.5	0.05	39.2	52.2	63.8	40
BZT52C62S	1E	58	62	66	2	215	500	0.5	0.05	43.4	58.8	71.6	35
BZT52C68S	1F	64	68	72	2	240	500	0.5	0.05	47.6	65.6	79.8	35
BZT52C75S	1G	70	75	79	2	255	500	0.5	0.05	52.5	73.4	88.6	35

Zener voltage is measured with a pulse test current I<sub>Z</sub> at an ambient temperature of 25°C.

## Rating and characteristic curves (BZT52S Series)

FIG.1-EFFECT OF ZENER VOLTAGE ON ZENER IMPEDANCE

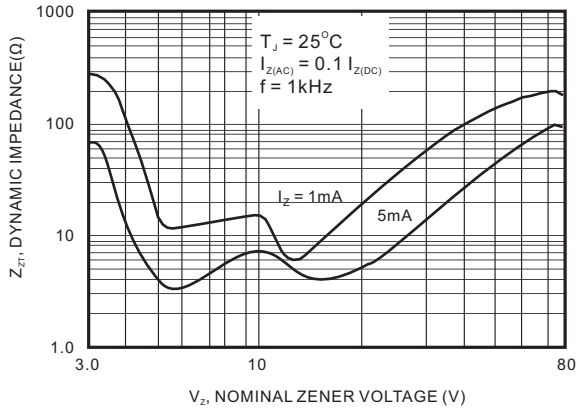

FIG. 2-TYPICAL FORWARD VOLTAGE

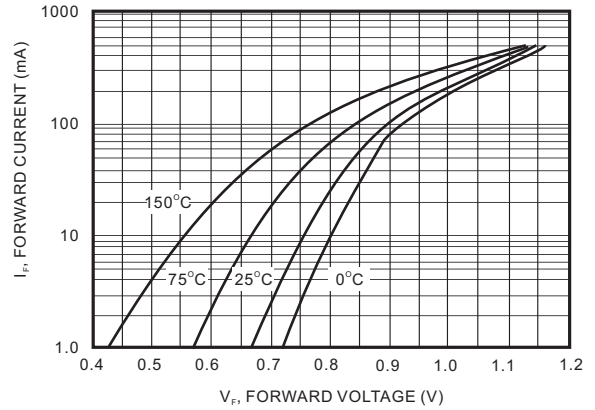

FIG. 3-TYPICAL CAPACITANCE

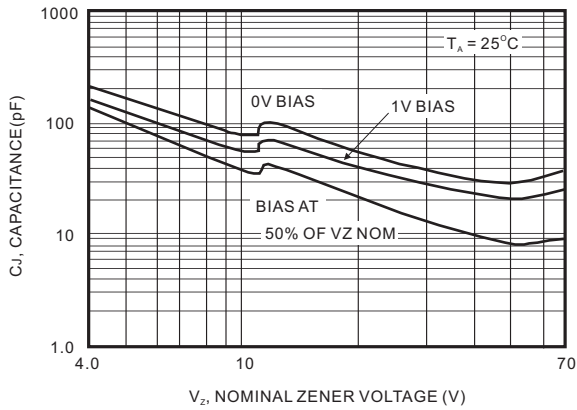
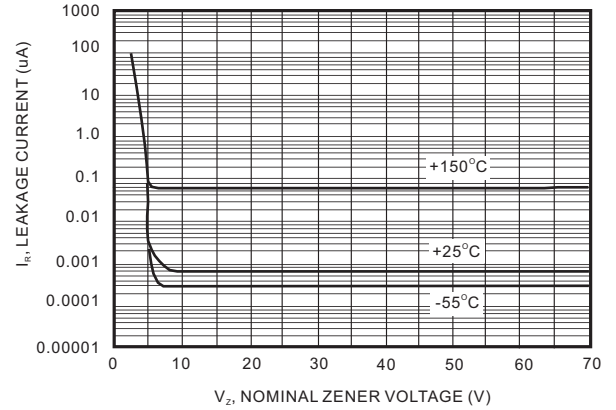

FIG. 4-TYPICAL LEAKAGE CURRENT



## Rating and characteristic curves (BZT52S Series)

FIG. 5-ZENER VOLTAGE VERSUS ZENER CURRENT  
( $V_z$  UP TO 12V)

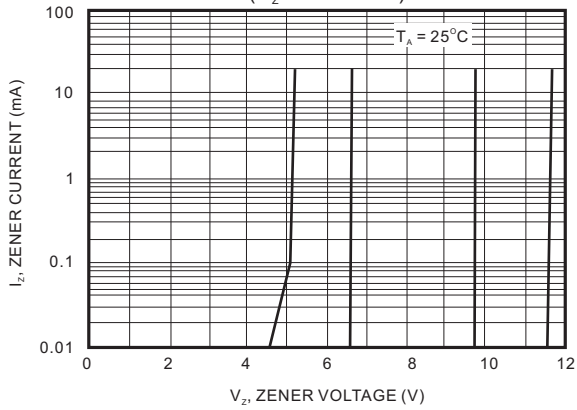

FIG. 6-ZENER VOLTAGE VERSUS  
ZENER CURRENT (12V TO 75V)

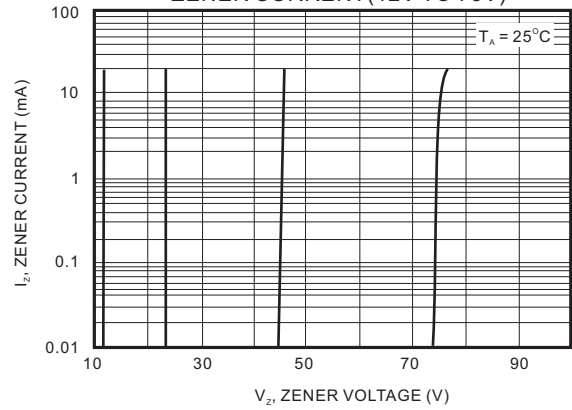
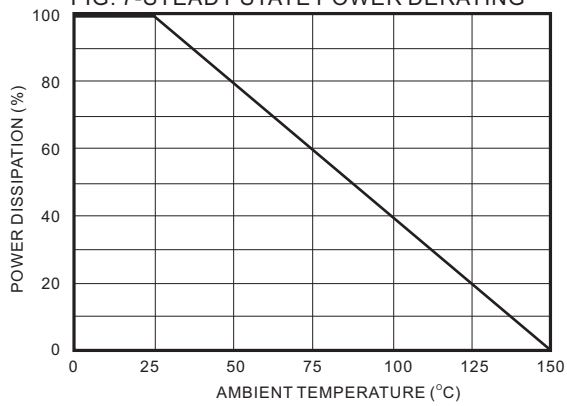



FIG. 7-STEADY STATE POWER DERATING



# BZT52S Series

## Pinning information

Pin	Simplified outline	Symbol
Pin1 cathode Pin2 anode		

## Suggested solder pad layout

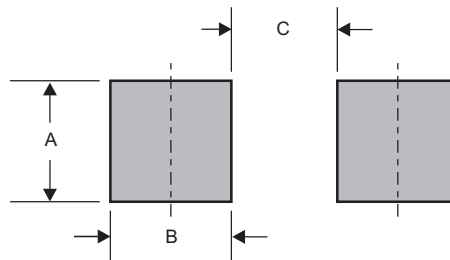

Dimensions in inches and (millimeters)

PACKAGE	A	B	C
SOD-323F	0.033 (0.83)	0.025 (0.63)	0.063 (1.60)

# BZT52S Series

## Packing information

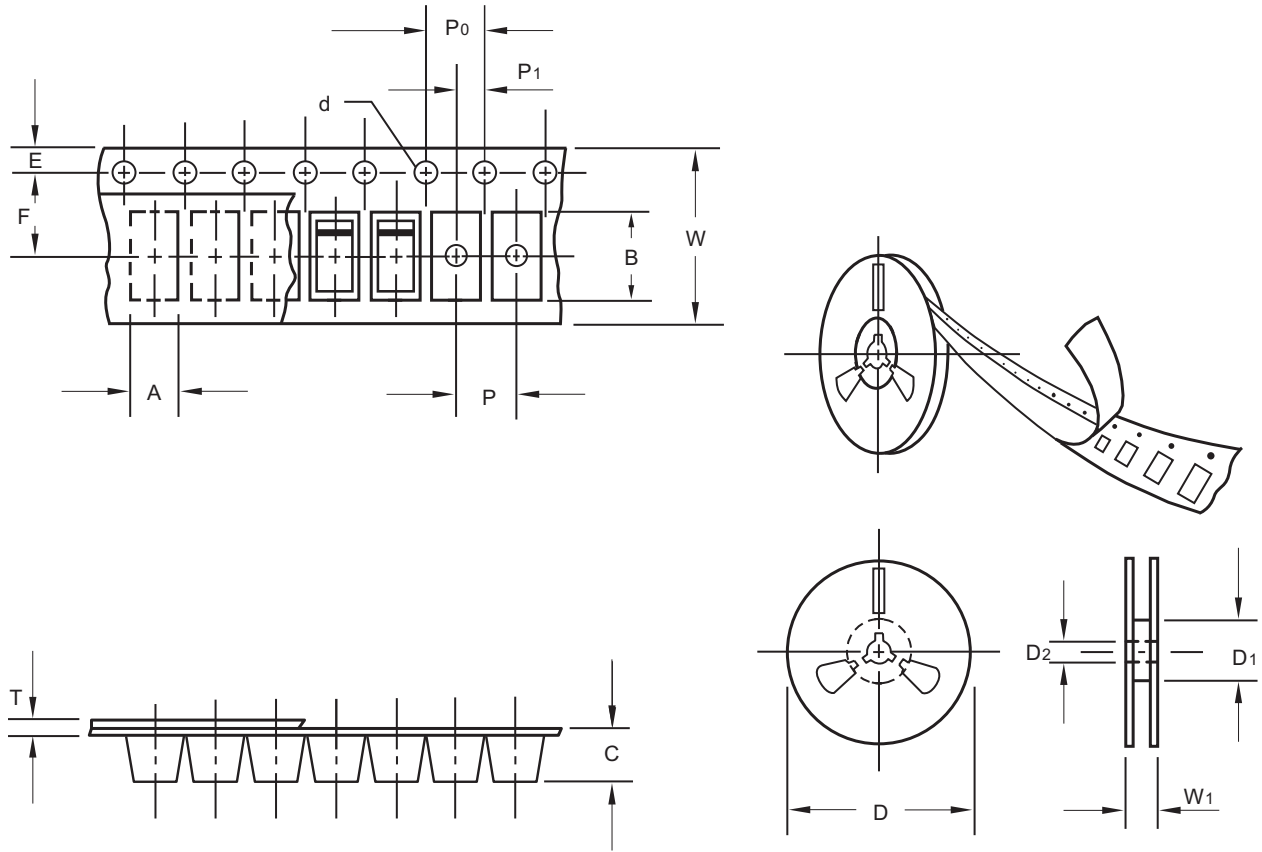

unit:mm

Item	Symbol	Tolerance	SOD-323F
Carrier width	A	0.1	1.46
Carrier length	B	0.1	2.95
Carrier depth	C	0.1	1.25
Sprocket hole	d	0.1	1.50
13" Reel outside diameter	D	2.0	-
13" Reel inner diameter	D1	min	-
7" Reel outside diameter	D	2.0	178.00
7" Reel inner diameter	D1	min	62.00
Feed hole diameter	D2	0.5	13.00
Sprocket hole position	E	0.1	1.75
Punch hole position	F	0.1	3.50
Punch hole pitch	P	0.1	4.00
Sprocket hole pitch	P0	0.1	4.00
Embossment center	P1	0.1	2.00
Overall tape thickness	T	0.1	0.23
Tape width	W	0.3	8.00
Reel width	W1	1.0	11.40

Note: Devices are packed in accordance with EIA standard RS-481-A and specifications listed above.

# BZT52S Series

## Reel packing

PACKAGE	REEL SIZE	REEL (pcs)	COMPONENT SPACING (m/m)	BOX (pcs)	INNER BOX (m/m)	REEL DIA, (m/m)	CARTON SIZE (m/m)	CARTON (pcs)	APPROX. GROSS WEIGHT (kg)
SOD-323F	7"	3,000	4.0	30,000	183*123*183	178	382*257*387	240,000	8.0

## Suggested thermal profiles for soldering processes

- 1.Storage environment: Temperature=5°C~40°C Humidity=55%±25%
- 2.Reflow soldering of surface-mount devices

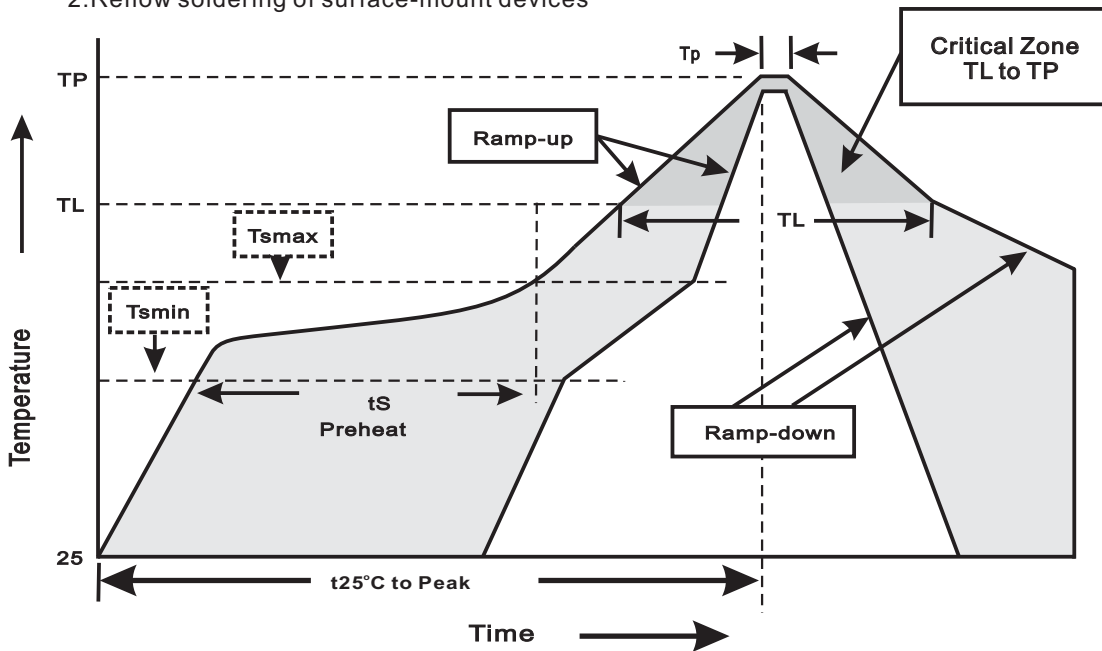

### 3.Reflow soldering

Profile Feature	Soldering Condition
Average ramp-up rate(T <sub>L</sub> to T <sub>P</sub> )	<3°C/sec
Preheat -Temperature Min(T <sub>min</sub> ) -Temperature Max(T <sub>max</sub> ) -Time(min to max)(t <sub>s</sub> )	150°C 200°C 60~120sec
T <sub>max</sub> to T <sub>L</sub> -Ramp-upRate	<3°C/sec
Time maintained above: -Temperature(T <sub>L</sub> ) -Time(t <sub>L</sub> )	217°C 60~260sec
Peak Temperature(T <sub>P</sub> )	255°C-0/+5°C
Time within 5°C of actual Peak Temperature(t <sub>P</sub> )	10~30sec
Ramp-down Rate	<6°C/sec
Time 25°C to Peak Temperature	<6minutes



## BZT52S Series

### High reliability test capabilities

Item Test	Conditions	Reference
1. Solder Resistance	at 260±5°C for 10±2sec.	MIL-STD-750D METHOD-2031
2. Solderability	at 245±5°C for 5 sec.	MIL-STD-202F METHOD-208
3. High Temperature Reverse Bias	$V_z = V_z \text{Nom} * 80\%$ at $T_j = 150^\circ\text{C}$ for 168 hrs.	MIL-STD-750D METHOD-1038
4. Pressure Cooker	15P <sub>sig</sub> at $T_A = 121^\circ\text{C}$ for 4 hrs.	JESD22-A102
5. Temperature Cycling	-55°C to +125°C dwelled for 30 min. and transferred for 5min. total 10 cycles.	MIL-STD-750D METHOD-1051
6. Humidity	at $T_A = 85^\circ\text{C}$ , RH=85% for 1000hrs.	MIL-STD-750D METHOD-1021
7. High Temperature Storage Life	at 175°C for 1000 hrs.	MIL-STD-750D METHOD-1031