

Surface Mount Schottky Barrier Rectifier

Reverse Voltage - 20 to 200V Forward Current - 5.0A

FEATURES

- Metal silicon junction, majority carrier conduction
- For surface mounted applications
- Low power loss, high efficiency
- High forward surge current capability
- For use in low voltage, high frequency inverters, free wheeling, and polarity protection applications

MECHANICAL DATA

- Case: SMAF
- Terminals: Solderable per MIL-STD-750, Method 2026
- Approx. Weight: 27mg 0.00086oz

Absolute Maximum Ratings and Electrical characteristics

Ratings at 25 °C ambient temperature unless otherwise specified. Single phase, half wave, 60Hz resistive or inductive load, for capacitive load, derate by 20 %

PINNING

PIN	DESCRIPTION
1	Cathode
2	Anode

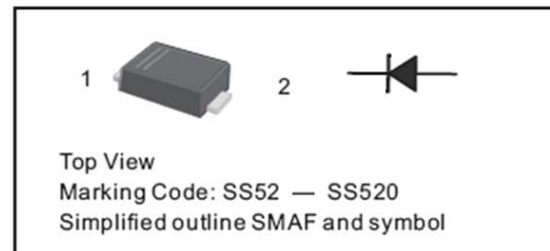

Parameter	Symbols	SS52F	SS54F	SS56F	SS58F	SS510F	SS512F	SS515F	SS520F	Units
Maximum Repetitive Peak Reverse Voltage	V_{RRM}	20	40	60	80	100	120	150	200	V
Maximum RMS voltage	V_{RMS}	14	28	42	56	70	84	105	140	V
Maximum DC Blocking Voltage	V_{DC}	20	40	60	80	100	120	150	200	V
Maximum Average Forward Rectified Current	$I_{F(AV)}$	5.0								A
Peak Forward Surge Current, 8.3ms Single Half Sine-wave Superimposed on Rated Load (JEDEC method)	I_{FSM}	150								A
Max Instantaneous Forward Voltage at 5A	V_F	0.45	0.55	0.70		0.85			V	
Maximum DC Reverse Current $T_a = 25^\circ\text{C}$ at Rated DC Reverse Voltage $T_a = 100^\circ\text{C}$	I_R	1.0 50								mA
Typical Junction Capacitance ¹⁾	C_j	800		500						pF
Typical Thermal Resistance ²⁾	$R_{\theta JA}$	55								°C/W
Operating Junction Temperature Range	T_j	-55 ~ +125								°C
Storage Temperature Range	T_{stg}	-55 ~ +150								°C

1) Measured at 1MHz and applied reverse voltage of 4 V D.C. 2) P.C.B. mounted with 0.2 X 0.2" (5 X 5 mm) copper pad areas.

SHIKE MAKE CONSCIOUS PRODUCT

CONSCIOUS PRODUCTS BEGIN WITH CONSCIOUS PEOPLE

REV.07



www.shike.tw

Fig.1 Forward Current Derating Curve

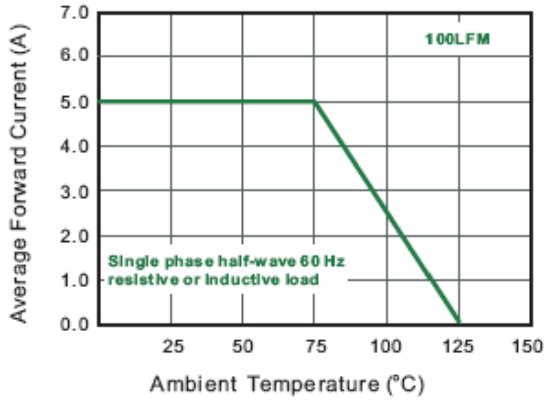

Fig.2 Typical Reverse Characteristics

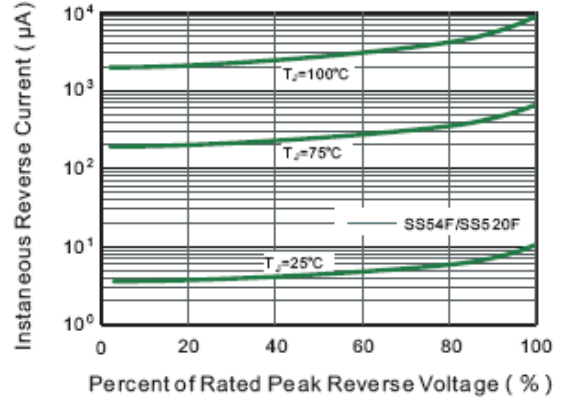

Fig.3 Typical Forward Characteristic

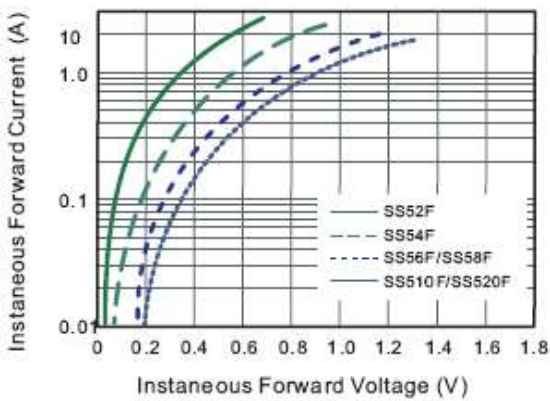

Fig.4 Typical Junction Capacitance

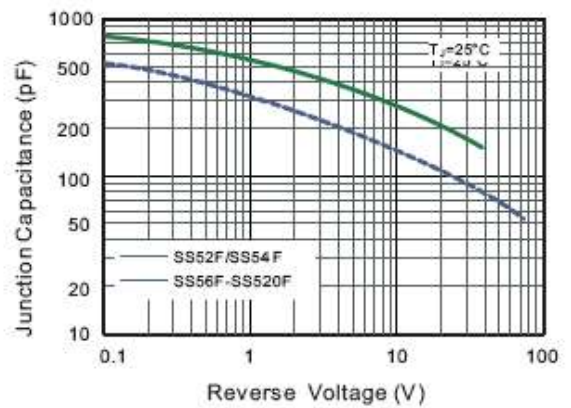

Fig.5 Maximum Non-Repetitive Peak Forward Surge Current

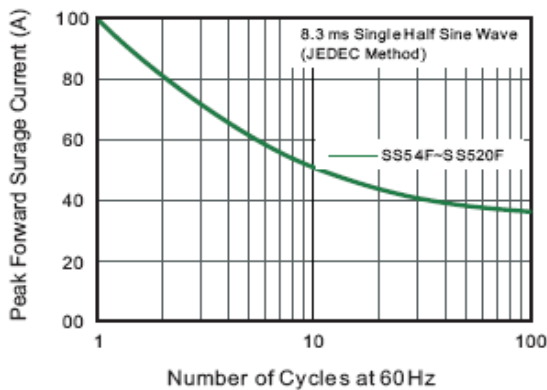
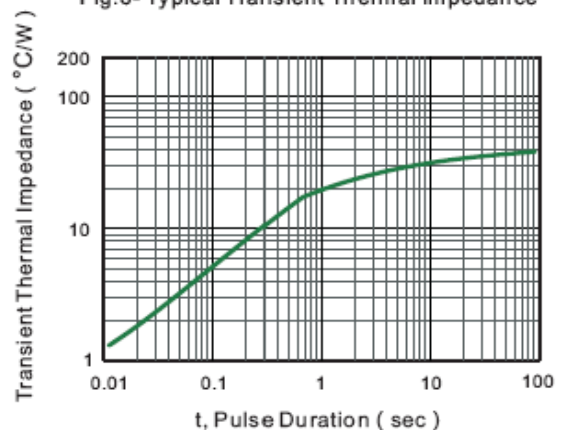

Fig.6- Typical Transient Thermal Impedance



SHIKE MAKE CONSCIOUS PRODUCT
CONSCIOUS PRODUCTS BEGIN WITH CONSCIOUS PEOPLE



PACKAGE OUTLINE

Plastic surface mounted package; 2 leads

SMAF

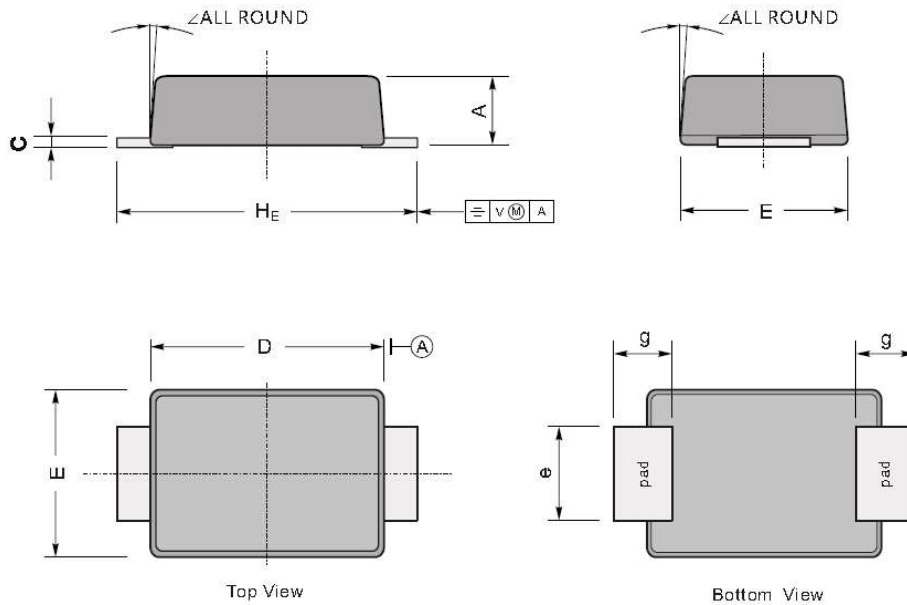

UNIT		A	C	D	E	e	g	HE	∠
mm	max	1.1	0.20	3.7	2.7	1.6	1.2	4.9	7°
	min	0.9	0.12	3.3	2.4	1.3	0.8	4.4	
mil	max	43	7.9	146	106	63	47	193	
	min	35	4.7	130	94	51	31	173	

The recommended mounting pad size

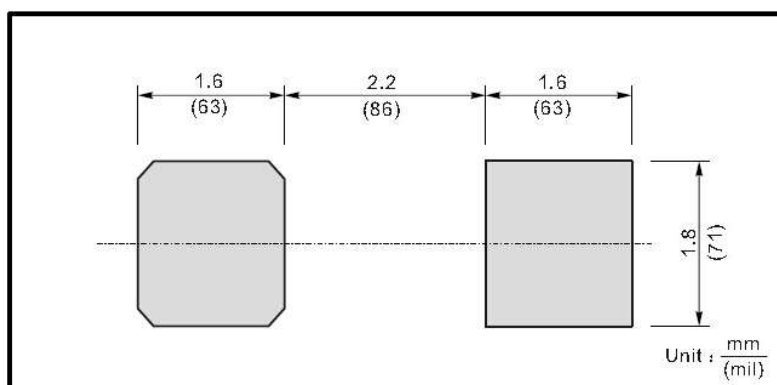

SHIKE MAKE CONSCIOUS PRODUCT
CONSCIOUS PRODUCTS BEGIN WITH CONSCIOUS PEOPLE

