



**Surface Mount Superfast Recovery Rectifier**

**Reverse Voltage – 50 to 600 V**

**Forward Current – 1 A**

**FEATURES**

- For surface mounted applications
- Low profile package
- Glass Passivated Chip Junction
- Superfast reverse recovery time
- Lead free in comply with EU RoHS 2011/65/EU directives

**MECHANICAL DATA**

- Case: SMA
- Terminals: Solderable per MIL-STD-750, Method 2026
- Approx. Weight: 0.055g / 0.002oz

**PINNING**

PIN	DESCRIPTION
1	Cathode
2	Anode

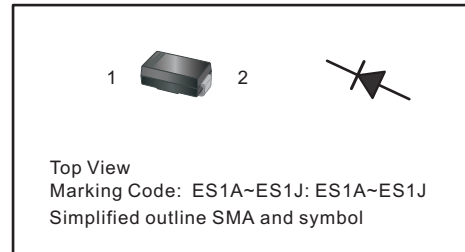

**Absolute Maximum Ratings and Characteristics**

Ratings at 25 °C ambient temperature unless otherwise specified. Single phase, half wave, 60 Hz, resistive or inductive load. For capacitive load, derate current by 20%.

Parameter	Symbols	ES1A	ES1B	ES1C	ES1D	ES1E	ES1G	ES1J	Units
Maximum Repetitive Peak Reverse Voltage	$V_{RRM}$	50	100	150	200	300	400	600	V
Maximum RMS voltage	$V_{RMS}$	35	70	105	140	210	280	420	V
Maximum DC Blocking Voltage	$V_{DC}$	50	100	150	200	300	400	600	V
Maximum Average Forward Rectified Current at $T_L = 100\text{ }^\circ\text{C}$	$I_{F(AV)}$	1							A
Peak Forward Surge Current 8.3 ms Single Half Sine Wave Superimposed on Rated Load (JEDEC Method)	$I_{FSM}$	30							A
Maximum Forward Voltage at 1 A	$V_F$	1				1.25		1.70	V
Maximum DC Reverse Current at Rated DC Blocking Voltage $T_a = 25\text{ }^\circ\text{C}$ $T_a = 125\text{ }^\circ\text{C}$	$I_R$	5 100							$\mu\text{A}$
Typical Junction Capacitance at $V_R=4\text{V}$ , $f=1\text{MHz}$	$C_j$	15							pF
Maximum Reverse Recovery Time <sup>(1)</sup>	$t_{rr}$	35							ns
Typical Thermal Resistance <sup>(2)</sup>	$R_{\theta JA}$	110							$^\circ\text{C/W}$
Operating and Storage Temperature Range	$T_j, T_{stg}$	-55 ~ +150							$^\circ\text{C}$

( 1 ) Measured with  $I_F = 0.5\text{ A}$ ,  $I_R = 1\text{ A}$ ,  $I_{rr} = 0.25\text{ A}$ .

( 2 ) P.C.B. mounted with 1.0 X 1.0" (2.54 X 2.54 cm) copper pad areas.



Fig.1 Reverse Recovery Time Characteristic And Test Circuit Diagram

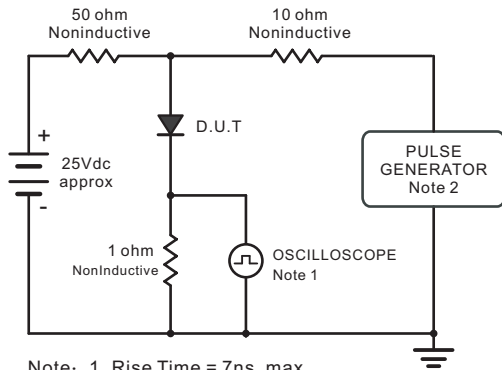

Note: 1. Rise Time = 7ns, max.  
Input Impedance = 1megohm, 22pF.  
2. Rise Time = 10ns, max.  
Source Impedance = 50 ohms.

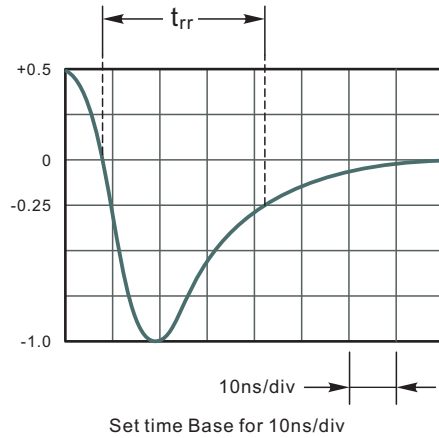

Fig.2 Maximum Average Forward Current Rating

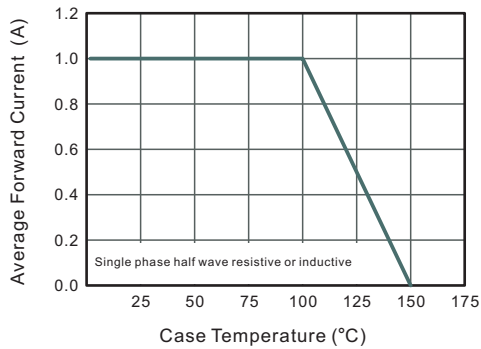

Fig.3 Typical Reverse Characteristics

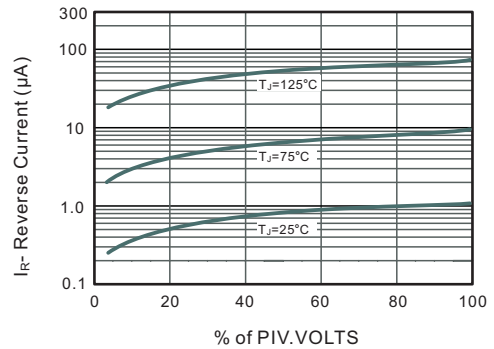

Fig.4 Typical Forward Characteristics

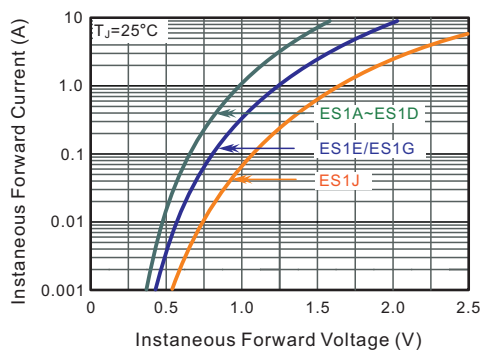

Fig.5 Typical Junction Capacitance

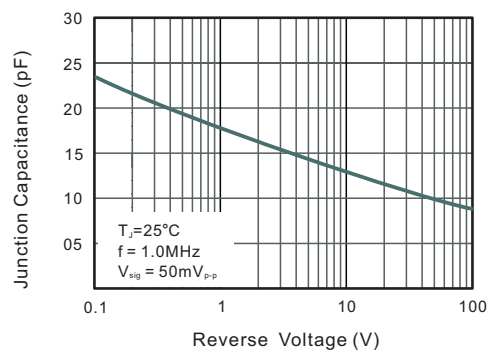
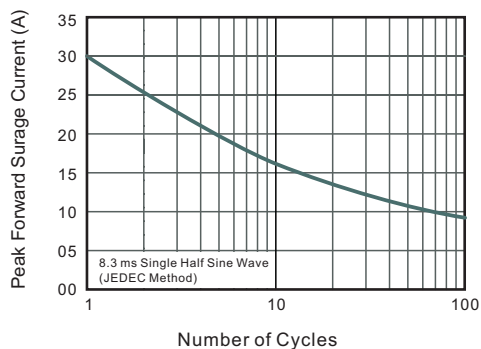

Fig.6 Maximum Non-Repetitive Peak Forward Surge Current





**PACKAGE OUTLINE**

Plastic surface mounted package; 2 leads

SMA

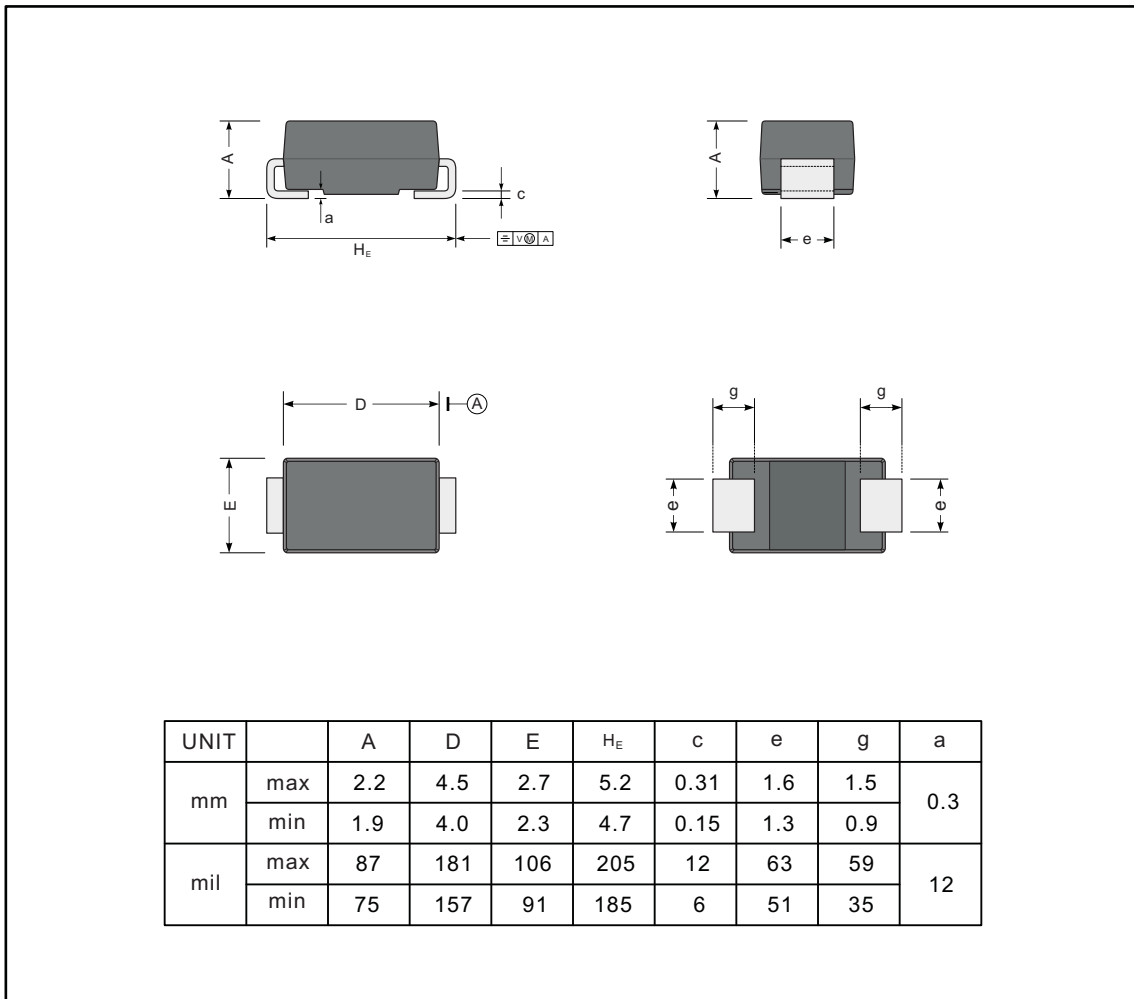

**The recommended mounting pad size**

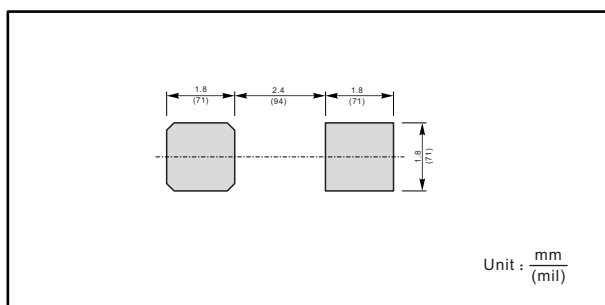

**Marking**

Type number	Marking code
ES1A	ES1A
ES1B	ES1B
ES1C	ES1C
ES1D	ES1D
ES1E	ES1E
ES1G	ES1G
ES1J	ES1J