

**Chip EMIFIL® LC Combined Monolithic**  
**NFL18ST□07X1C3□** **Reference Specification**

**1. Scope**

This reference specification applies to Chip EMIFIL® LC Combined Monolithic Type NFL18ST\_X Series.

**2. Part Numbering**

$\frac{\text{NF}}{\text{Product ID}}$      $\frac{\text{L}}{\text{Structure}}$      $\frac{18}{\text{Dimension (L×W)}}$      $\frac{\text{ST}}{\text{Features}}$      $\frac{207}{\text{Cut-off Frequency}}$      $\frac{\text{X}}{\text{Characteristics}}$      $\frac{1\text{C}}{\text{Rated Voltage}}$      $\frac{3}{\text{Electrode}}$      $\frac{\text{D}}{\text{Packaging Code (D: Taping / B: Bulk)}}$

**3. Rating**

Customer Part Number	MURATA Part Number	Cut-off Frequency [MHz]	Capacitance [pF]	Inductance (L) [nH]	DC Resistance [Ω max.]	Rated Current [mA(DC)]	Insulation Resistance [MΩ min.]	Rated Voltage [V(DC)]	Withstanding Voltage [V(DC)]
	NFL18ST207X1C3D	200	25±20%	110±20%	3.5	150	1000	16	50
	NFL18ST207X1C3B								
	NFL18ST307X1C3D	300	18±20%	62±20%	1.8	200			
	NFL18ST307X1C3B								
	NFL18ST507X1C3D	500	10±20%	43±20%	1.5				
	NFL18ST507X1C3B								

- Operating Temperature : -55°C to +125°C (Includes self-heating.)
- Storage Temperature : -55°C to +125°C

**4. Standard Testing Condition**

< Unless otherwise specified >

Temperature: Ordinary Temp. / 15 °C to 35 °C  
 Humidity: Ordinary Humidity / 25 %(RH) to 85 %(RH)

< In case of doubt >

Temperature: 20 °C ± 2 °C  
 Humidity: 60 %(RH) to 70 %(RH)  
 Atmospheric pressure: 86 kPa to 106 kPa

**5. Style and Dimensions**

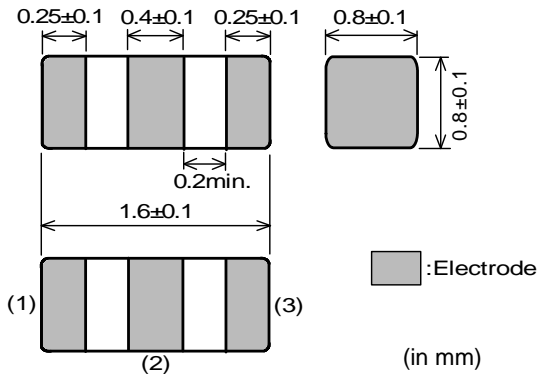

■ Equivalent Circuits

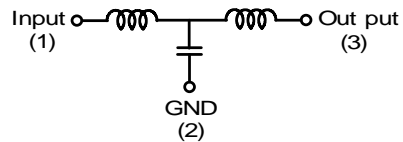

※No Polarity

■ Unit Mass(Typical value)

0.004g

■ Insertion Loss Characteristics (I.L.) (Typ.) (50 Ω system)

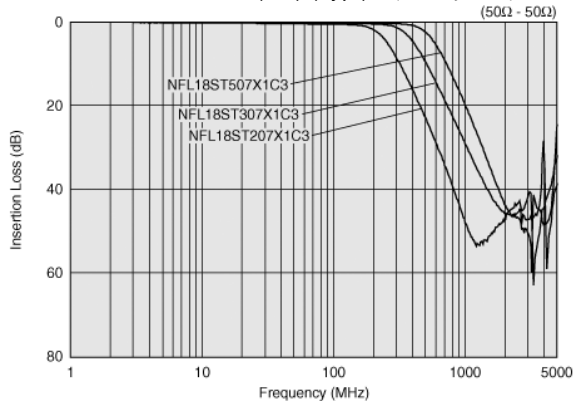

**6. Marking**

No marking

## 7. Electrical Performance

No.	Item	Specification	Test Method
7.1	Capacitance (Cap.)	Meet item 3.	<ul style="list-style-type: none"> <li>Frequency : <math>1\pm 0.1\text{MHz}</math></li> <li>Voltage : <math>1\pm 0.2\text{V(rms)}</math></li> </ul>
7.2	Inductance (L)		<ul style="list-style-type: none"> <li>Frequency : <math>10\pm 1\text{MHz}</math></li> <li>Voltage : <math>1\pm 0.2\text{V(rms)}</math></li> </ul>
7.3	DC Resistance (Rdc)	Meet item 3.	Measured with 10mA max. Measured between terminal (1)-(3). (ref. Item5)
7.4	Insulation Resistance(I.R.)		<ul style="list-style-type: none"> <li>Voltage : Rated Voltage</li> <li>Time : 1 minutes max.</li> </ul>
7.5	Withstanding Voltage	Products shall not be damaged.	<ul style="list-style-type: none"> <li>Test Voltage : 50V(DC)</li> <li>Time : 1 to 5 s</li> <li>Charge Current : 50 mA max.</li> </ul>

## 8. Mechanical Performance

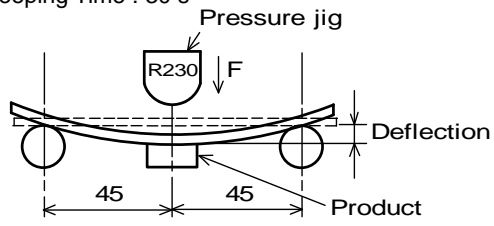
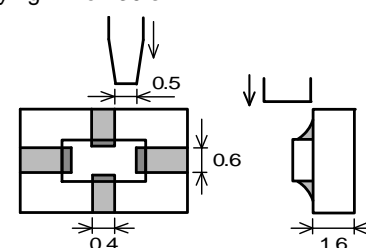
No.	Item	Specification	Test Method										
8.1	Appearance and Dimensions	Meet item 5.	Visual Inspection and measured with Slide Calipers.										
8.2	Solderability	Electrodes shall be at least 90% covered with new solder coating.	<ul style="list-style-type: none"> <li>Flux : Ethanol solution of rosin, 25(wt)%</li> <li>Pre-heat : <math>150 \pm 10^\circ\text{C}</math>, 60 to 90s</li> <li>Solder : Sn-3.0Ag-0.5Cu</li> <li>Solder Temperature : <math>240 \pm 3^\circ\text{C}</math></li> <li>Immersion Time : <math>3\pm 1</math> s</li> <li>Immersion and emersion rates : 25mm / s</li> </ul>										
8.3	Resistance to soldering heat	Meet Table 1.  <table border="1"> <thead> <tr> <th colspan="2">Table 1</th> </tr> </thead> <tbody> <tr> <td>Appearance</td> <td>No damaged</td> </tr> <tr> <td>Cap. Change</td> <td>Within <math>\pm 5\%</math></td> </tr> <tr> <td>L Change</td> <td>Within <math>\pm 10\%</math></td> </tr> <tr> <td>I.R.</td> <td>Meet item 3</td> </tr> </tbody> </table>	Table 1		Appearance	No damaged	Cap. Change	Within $\pm 5\%$	L Change	Within $\pm 10\%$	I.R.	Meet item 3	<ul style="list-style-type: none"> <li>Flux : Ethanol solution of rosin, 25(wt)%</li> <li>Pre-heat : <math>150 \pm 10^\circ\text{C}</math>, 60 to 90s</li> <li>Solder : Sn-3.0Ag-0.5Cu</li> <li>Solder Temperature : <math>270 \pm 5^\circ\text{C}</math></li> <li>Immersion Time : <math>10 \pm 1</math> s</li> <li>Immersion and emersion rates : 25mm / s</li> <li>Then measured after exposure in the room condition for <math>24\pm 2</math> hours.</li> </ul>
Table 1													
Appearance	No damaged												
Cap. Change	Within $\pm 5\%$												
L Change	Within $\pm 10\%$												
I.R.	Meet item 3												
8.4	Bending Strength	Meet Table 2.  <table border="1"> <thead> <tr> <th colspan="2">Table 2</th> </tr> </thead> <tbody> <tr> <td>Appearance</td> <td>No damaged</td> </tr> <tr> <td>Cap. Change</td> <td>Within <math>\pm 5\%</math></td> </tr> </tbody> </table>	Table 2		Appearance	No damaged	Cap. Change	Within $\pm 5\%$	It shall be soldered on the glass-epoxy substrate ( $t = 1.0\text{mm}$ ). <ul style="list-style-type: none"> <li>Deflection : 2 mm</li> <li>Keeping Time : 30 s</li> </ul> 				
Table 2													
Appearance	No damaged												
Cap. Change	Within $\pm 5\%$												
8.5	Drop	Products shall be no failure after tested.	It shall be dropped on concrete or steel board. <ul style="list-style-type: none"> <li>Method : Free fall</li> <li>Height : 1m</li> <li>Attitude from which the product is dropped : 3 directions</li> <li>The Number of Time : 3 times for each direction (Total 9 times)</li> </ul>										
8.6	Bonding Strength	The electrodes shall be no failure after tested.	It shall be soldered on the glass-epoxy substrate. <ul style="list-style-type: none"> <li>Applying Force (F) : 9.8 N</li> <li>Applying Time : 30 s</li> </ul> 										

No.	Item	Specification	Test Method
8.7	Vibration	Meet Table 1.	It shall be soldered on the glass-epoxy substrate. <ul style="list-style-type: none"> <li>• Oscillation Frequency : 10 to 55Hz for 1 minute</li> <li>• Double Amplitude : 1.5 mm</li> <li>• Time: A period of 2 hours in each of 3 mutually perpendicular directions. (Total 6 hours)</li> </ul>

### 9. Environment Performance

It shall be soldered on the glass-epoxy substrate.

No.	Item	Specification	Test Method
9.1	Temperature Cycling	Meet Table 1.	<ul style="list-style-type: none"> <li>• 1 Cycle <ul style="list-style-type: none"> <li>1 step : <math>-55 \pm 0_3</math> °C / <math>30 \pm 3_0</math> min</li> <li>2 step : Room Temperature / within 3 min</li> <li>3 step : <math>+125 \pm 3_0</math> °C / <math>30 \pm 3_0</math> min</li> <li>4 step : Room Temperature / within 3 min</li> </ul> </li> <li>• Total of 10 cycles</li> <li>• Then measured after exposure in the room condition for 24±2 hours.</li> </ul>
9.2	Humidity		<ul style="list-style-type: none"> <li>• Temperature : <math>40 \pm 2</math> °C</li> <li>• Humidity : 90 to 95%(RH)</li> <li>• Time : <math>500 \pm 24_0</math> hours</li> <li>• Then measured after exposure in the room condition for 24±2 hours.</li> </ul>
9.3	Heat Life		<ul style="list-style-type: none"> <li>• Temperature : <math>125 \pm 2</math> °C</li> <li>• Test Voltage : Rated Voltage × 200%</li> <li>• Charge Current : 50 mA max.</li> <li>• Time : <math>1000 \pm 48_0</math> hours</li> <li>• Then measured after exposure in the room condition for 24±2 hours.</li> </ul>

### 10. Specification of Packaging

#### 10.1. Appearance and Dimensions (8mm-wide paper tape)

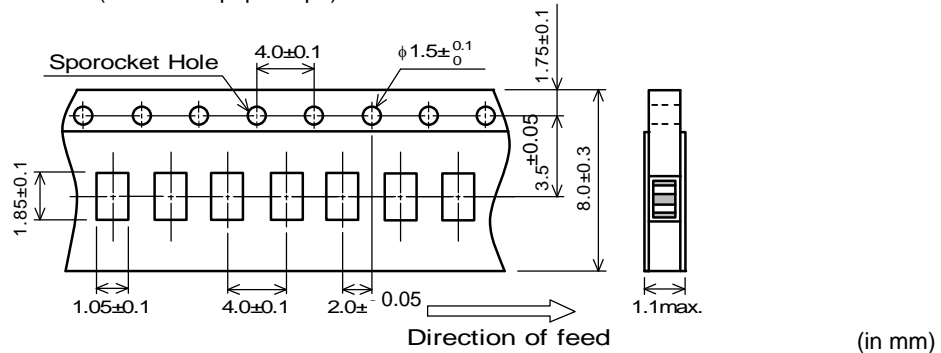

#### 10.2. Specification of Taping

- (1) Packing quantity (standard quantity)  
4000 pcs. / reel
- (2) Packing Method  
Products shall be packaged in the cavity of the base tape and sealed by top tape and bottom tape.
- (3) Sprocket Hole  
The sprocket holes are to the right as the tape is pulled toward the user.
- (4) Base tape and Top tape  
The base tape and top tape have no spliced point.
- (5) Cavity  
There shall not be burr in the cavity.
- (6) Missing components number  
Missing components number within 0.1% of the number per reel or 1 pc., whichever is greater, and are not continuous. The specified quantity per reel is kept.

10.3. Pull Strength of Top Tape and Bottom Tape

Top tape	5N min.
Bottom tape	

10.4. Peeling off force of top tape  
 0.1N to 0.6N (minimum value is typical)  
 Speed of Peeling off : 300 mm / min

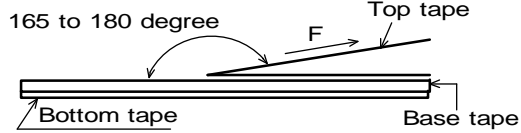

10.5. Dimensions of Leader-tape, Trailer and Reel

There shall be leader-tape (top tape and empty tape) and trailer-tape (empty tape) as follows.

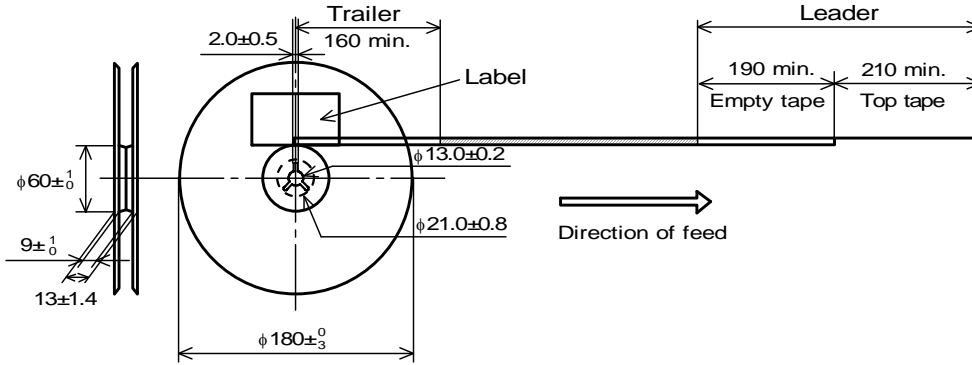

(in mm)

10.6. Marking for reel

Customer part number , MURATA part number , Inspection number(\*1) , RoHS marking(\*2) , Quantity , etc

\*1) « Expression of Inspection No. »

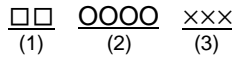

- (1) Factory Code
- (2) Date
- (3) Serial No.

First digit : Year / Last digit of year  
 Second digit : Month / Jan. to Sep. → 1 to 9, Oct. to Dec. → O,N,D  
 Third, Fourth digit : Day

\*2) « Expression of RoHS marking »

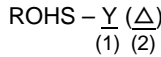

- (1) RoHS regulation conformity parts.
- (2) MURATA classification number

10.7. Marking for Outside package (corrugated paper box)

Customer name , Purchasing Order Number , Customer Part Number , MURATA part number , RoHS marking (\*2) , Quantity , etc

10.8. Specification of Outer Case

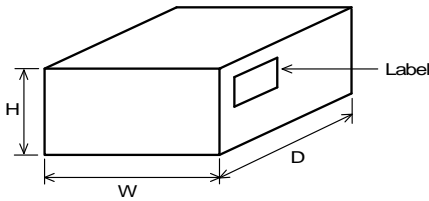

Outer Case Dimensions (mm)			Standard Reel Quantity in Outer Case (Reel)
W	D	H	
186	186	93	5

\* Above Outer Case size is typical. It depends on a quantity of an order.

**11. Standard Land Dimensions**

The chip EMI filter suppresses noise by conducting the high-frequency noise element to ground. Therefore, to get enough noise reduction, feed through holes which is connected to ground-plane should be arranged according to the figure to reinforce the ground-pattern.

- < Standard land dimensions for reflow >
- Side on which chips are mounted

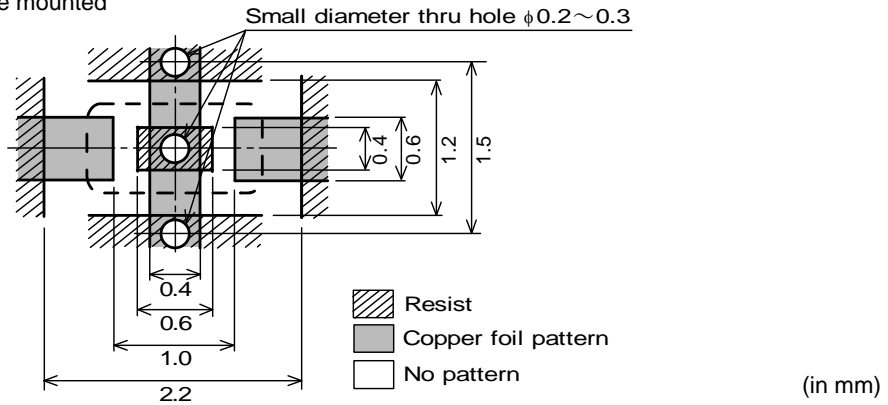

**12. ⚠ Caution**

Limitation of Applications

Please contact us before using our products for the applications listed below which require especially high reliability for the prevention of defects which might directly cause damage to the third party's life, body or property.

- (1) Aircraft equipment (2) Aerospace equipment (3) Undersea equipment (4) Power plant control equipment
- (5) Medical equipment (6) Transportation equipment(automobiles, trains, ships, etc.) (7) Traffic signal equipment
- (8) Disaster prevention / crime prevention equipment (9) Data-processing equipment
- (10) Applications of similar complexity or with reliability requirements comparable to the applications listed in the above

**13. Notice**

Products can only be soldered with reflow.  
 This product is designed for solder mounting.  
 Please consult us in advance for applying other mounting method such as conductive adhesive.

13.1. Flux and Solder

Flux	Use rosin-based flux, Do not use highly acidic flux (with chlorine content exceeding 0.2(wt)%). Do not use water-soluble flux.
Solder	Use Sn-3.0Ag-0.5Cu solder

Other flux (except above) Please contact us for details, then use.

13.2. Note for Assembling

< Thermal Shock >

Pre-heating should be in such a way that the temperature difference between solder and products surface is limited to 100°C max. Also cooling into solvent after soldering should be in such a way that the temperature difference is limited to 100°C max.

13.3. Attention Regarding P.C.B. Bending

The following shall be considered when designing P.C.B.'s and laying out products.

- (1) P.C.B. shall be designed so that products are not subject to the mechanical stress for board warpage.

[Products direction]

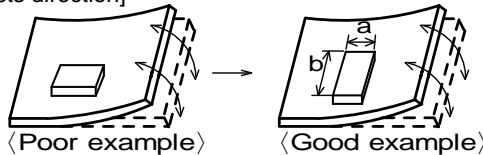

Products shall be located in the sideways direction (Length:a < b) to the mechanical stress.

- (2) Products location on P.C.B. near seam for separation.

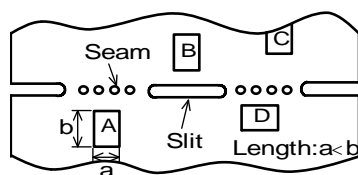

Products (A,B,C,D) shall be located carefully so that products are not subject to the mechanical stress due to warping the board. Because they may be subjected the mechanical stress in order of A > C > B ≅ D.

13.4. Pre-heating Temperature

Soldering shall be handled so that the difference between pre-heating temperature and solder temperature shall be limited to 100°C max. to avoid the heat stress for the products.

13.5. Reflow Soldering

1) Soldering paste printing for reflow

- Standard thickness of solder paste: 100µm to 150µm.
- Use the solder paste printing pattern of the right pattern.
- For the resist and copper foil pattern, use standard land dimensions.

• Standard printing pattern of solder paste.

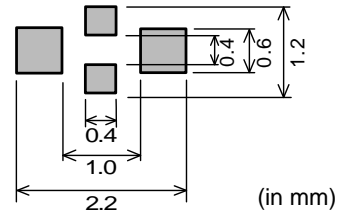

2) Soldering Conditions

Standard soldering profile and the limit soldering profile is as follows.

The excessive limit soldering conditions may cause leaching of the electrode and / or resulting in the deterioration of product quality.

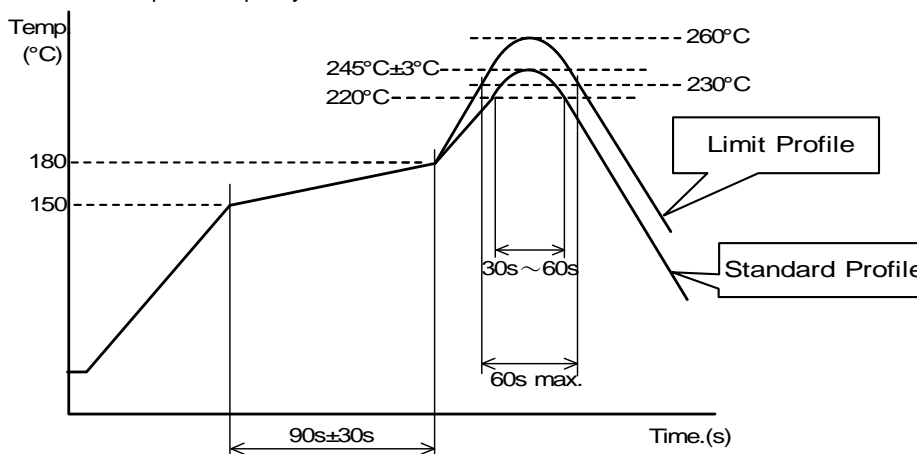

	Standard Profile	Limit Profile
Pre-heating	150°C ~ 180°C , 90s ± 30s	
Heating	above 220°C , 30s ~ 60s	above 230°C , 60s max.
Peak temperature	245°C ± 3°C	260°C , 10s
Cycle of reflow	2 times	2 times

13.6. Reworking with Soldering iron

The following conditions shall be strictly followed when using a soldering iron.

- Pre-heating : 150°C, 1 min
- Soldering iron output : 30W max.
- Tip temperature : 350°C max.
- Tip diameter : φ 3mm max.
- Soldering time : 3(+1,-0) s
- Times : 2times max.

Note: Do not directly touch the products with the tip of the soldering iron in order to prevent the crack on the ceramic material due to the thermal shock.

13.7. Solder Volume

Solder shall be used not to be exceeded as shown below.

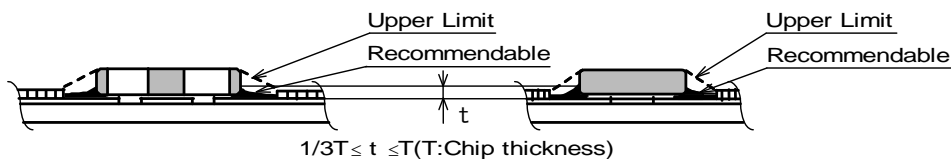

Accordingly increasing the solder volume, the mechanical stress to product is also increased. Excessive solder volume may cause the failure of mechanical or electrical performance.

## 13.8. Cleaning Conditions

Products shall be cleaned on the following conditions.

- (1) Cleaning temperature shall be limited to 60°C max. (40°C max. for Isopropyl alcohol (IPA))
- (2) Ultrasonic cleaning shall comply with the following conditions, with avoiding the resonance phenomenon at the mounted products and P.C.B.
  - Power: 20W / l max.
  - Frequency: 28kHz to 40kHz
  - Time: 5 minutes max.
- (3) Cleaner
  1. Cleaner
    - Isopropyl alcohol (IPA)
  2. Aqueous agent
    - PINE ALPHA ST-100S
- (4) There shall be no residual flux and residual cleaner after cleaning.
 

In the case of using aqueous agent, products shall be dried completely after rinse with de-ionized water in order to remove the cleaner.
- (5) Other cleaning
 

Please contact us.

## 13.9. Operating Environment

Do not use this product under the following environmental conditions, on deterioration of the performance, such as insulation resistance may result from the use.

- (1) in the corrodible atmosphere (acidic gases, alkaline gases, chlorine, sulfur gases, organic gases and etc.)
- (2) in the atmosphere where liquid such as organic solvent, may splash on the products.
- (3) in the atmosphere where the temperature / humidity changes rapidly and it is easy to dew.

## 13.10. Resin coating

The capacitance and inductance value may change and/or it may affect on the product's performance due to high cure-stress of resin to be used for coating / molding products. So please pay your careful attention when you select resin. In prior to use, please make the reliability evaluation with the product mounted in your application set.

## 13.11. Handling of a substrate

After mounting products on a substrate, do not apply any stress to the product caused by bending or twisting to the substrate when cropping the substrate, inserting and removing a connector from the substrate or tightening screw to the substrate.

Excessive mechanical stress may cause cracking in the product.

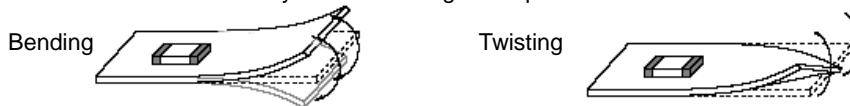

## 13.12. Storage condition

## (1) Storage period

Use the products within 12 months after delivered.  
Solderability should be checked if this period is exceeded.

## (2) Storage environment condition

• Products should be stored in the warehouse on the following conditions.

Temperature : -10 to +40°C  
Humidity : 15 to 85% relative humidity  
No rapid change on temperature and humidity

- Don't keep products in corrosive gases such as sulfur, chlorine gas or acid, or it may cause oxidization of electrode, resulting in poor solderability.
- Products should be stored on the palette for the prevention of the influence from humidity, dust and so on.
- Products should be stored in the warehouse without heat shock, vibration, direct sunlight and so on.
- Products should be stored under the airtight packaged condition.

## (3) Delivery

Care should be taken when transporting or handling product to avoid excessive vibration or mechanical shock.

14.  Note

- (1) Please make sure that your product has been evaluated in view of your specifications with our product being mounted to your product.
- (2) You are requested not to use our product deviating from the reference specifications.
- (3) The contents of this reference specification are subject to change without advance notice. Please approve our product specifications or transact the approval sheet for product specifications before ordering.