

TPS7A37 具有反向电流保护功能的 1% 高精度、1A 低压降稳压器

1 特性

- 与 1 μ F 或更大的陶瓷输出电容搭配工作时保持稳定
- 输入电压范围：2.2V 至 5.5V
- 超低压降电压：
 - 1A 时的最大电压为 200mV
- 出色的负载瞬态响应 - 即使与仅为 1 μ F 的输出电容搭配使用也依旧出色
- NMOS 拓扑结构可提供低反向泄漏电流
- 出色的精度：
 - 0.23% 标称准确度
 - 整个线路、负载和温度范围内的总精度为 1%
- 关断模式下的 I_Q 典型值小于 20nA
- 用于故障保护的热关断和电流限制

2 应用

- 针对数字信号处理器 (DSP)，现场可编程栅极阵列 (FPGA)，特定用途集成电路 (ASIC) 和微处理器的负载点调节
- 针对开关电源的后置调节
- 便携式和电池供电类设备

3 说明

TPS7A37 系列线性低压降 (LDO) 稳压器在一个电压随耦器配置中使用一个 N 沟道金属氧化物半导体 (NMOS) 导通元件。该拓扑结构对输出电容值和等效串联电阻 (ESR) 的敏感度相对较低，从而实现多种负载配置。负载瞬态响应出色，即使与 1 μ F 小型陶瓷输出电容搭配工作时也是如此。NMOS 拓扑结构也可实现极低压降。

TPS7A37 系列使用一个先进的双极互补金属氧化物半导体 (BiCMOS) 工艺，可在传送极低压降电压和低接地引脚电流的同时产生高精度。未使能状态下的电流消耗小于 20nA，非常适合便携式应用。这些器件受到热关断和折返电流限制的保护。

器件信息⁽¹⁾

器件型号	封装	封装尺寸 (标称值)
TPS7A37	WSON (6)	2.00mm x 2.00mm

(1) 要了解所有可用封装，请见数据表末尾的可订购产品附录。

典型应用电路 (可调电压型号)

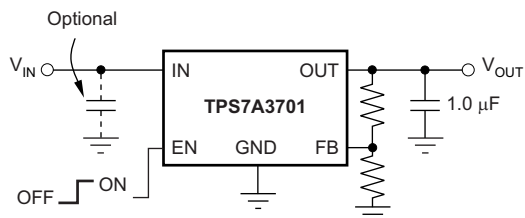

典型应用电路 (固定电压型号)

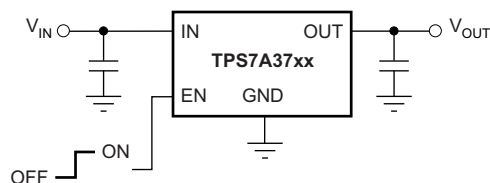

目录

<ul style="list-style-type: none"> 1 特性 1 2 应用 1 3 说明 1 4 修订历史记录 2 5 Pin Configuration and Functions 3 6 Specifications 3 <ul style="list-style-type: none"> 6.1 Absolute Maximum Ratings 3 6.2 ESD Ratings 3 6.3 Recommended Operating Conditions 4 6.4 Thermal Information 4 6.5 Electrical Characteristics 5 6.6 Typical Characteristics 6 7 Detailed Description 11 <ul style="list-style-type: none"> 7.1 Overview 11 7.2 Functional Block Diagrams 11 7.3 Feature Description 12 7.4 Device Functional Modes 13 	<ul style="list-style-type: none"> 8 Application and Implementation 14 <ul style="list-style-type: none"> 8.1 Application Information 14 8.2 Typical Applications 16 9 Power Supply Recommendations 19 10 Layout 19 <ul style="list-style-type: none"> 10.1 Layout Guidelines 19 10.2 Layout Example 19 10.3 Thermal Considerations 20 10.4 Power Dissipation 20 10.5 Estimating Junction Temperature 21 11 器件和文档支持 23 <ul style="list-style-type: none"> 11.1 文档支持 23 11.2 商标 23 11.3 静电放电警告 23 11.4 Glossary 23 12 机械、封装和可订购信息 23
---	---

4 修订历史记录

注：之前版本的页码可能与当前版本有所不同。

Changes from Revision A (July 2013) to Revision B	Page
<ul style="list-style-type: none"> • 已添加 ESD 额定值表，特性 描述部分，器件功能模式，应用和实施部分，电源相关建议部分，布局部分，器件和文档支持部分以及机械、封装和可订购信息部分。 1 • Changed Internal Reference (VFB) parameter typ value 5 	

Changes from Original (March 2013) to Revision A	Page
<ul style="list-style-type: none"> • 已更改 器件状态至“量产数据” 1 	

5 Pin Configuration and Functions

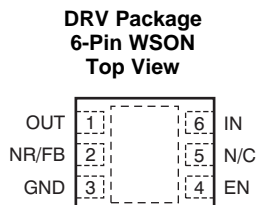

Power dissipation may limit operating range. Check [Thermal Information](#) table.

Pin Functions

PIN		I/O	DESCRIPTION
NAME	NO.		
EN	4	I	Driving the enable pin (EN) high turns on the regulator. Driving this pin low puts the regulator into shutdown mode. Refer to the Shutdown section under Applications Information for more details. EN must not be left floating and can be connected to IN if not used.
FB	2	I	Adjustable voltage version only—this pin is the input to the control loop error amplifier, and is used to set the output voltage of the device.
GND	3, Pad	—	Ground
IN	6	I	Unregulated input supply
N/C	5	—	Not connected
NR/FB	2	—	Fixed voltage versions only—connecting an external capacitor to this pin bypasses noise generated by the internal bandgap, reducing output noise to very low levels.
OUT	1	O	Regulator output. A 1.0- μ F or larger capacitor of any type is required for stability.
PowerPAD	—	—	

6 Specifications

6.1 Absolute Maximum Ratings

Over operating temperature range (unless otherwise noted).⁽¹⁾

		MIN	MAX	UNIT
Voltage	IN	-0.3	6	V
	EN	-0.3	6	V
	OUT	-0.3	5.5	V
	NR, FB	-0.3	6	V
Current	Peak output current	Internally limited		A
	Output short-circuit duration	Indefinite		A
Temperature	Operating junction, T_J	-55	150	°C
	Storage, T_{stg}	-65	150	°C

- (1) Stresses beyond those listed under *Absolute Maximum Ratings* may cause permanent damage to the device. These are stress ratings only, which do not imply functional operation of the device at these or any other conditions beyond those indicated under *Recommended Operating Conditions*. Exposure to absolute-maximum-rated conditions for extended periods may affect device reliability.

6.2 ESD Ratings

		VALUE	UNIT
$V_{(ESD)}$ Electrostatic discharge	Human-body model (HBM), per ANSI/ESDA/JEDEC JS-001 ⁽¹⁾	±2000	V
	Charged-device model (CDM), per JEDEC specification JESD22-C101 ⁽²⁾	±500	

- (1) JEDEC document JEP155 states that 500-V HBM allows safe manufacturing with a standard ESD control process.
(2) JEDEC document JEP157 states that 250-V CDM allows safe manufacturing with a standard ESD control process.

6.3 Recommended Operating Conditions

over operating free-air temperature range (unless otherwise noted)

	MIN	NOM	MAX	UNIT
V_{IN}	2.2		5.5	V
V_{OUT}	V_{FB}		$5.5 - V_{DO}$	V
V_{EN}	0		V_{IN}	
I_{OUT}	0		1	A
C_{IN}		1		μ F
$C_{OUT}^{(1)}$	1			μ F
C_{NR}		10		nF
$R_1^{(2)}$		$V_{OUT(nom)} \times 15.833$		k Ω
C_{FF}		10	100	nF

 (1) If the product of $C_{OUT} \times ESR < 50$ n Ω -F, the part may ring after a transient.

(2) This nominal value is for the best accuracy.

6.4 Thermal Information

THERMAL METRIC ⁽¹⁾		TPS7A37	UNIT
		DRV (WSON)	
		6 PINS	
$R_{\theta JA}$	Junction-to-ambient thermal resistance	67.2	$^{\circ}$ C/W
$R_{\theta JC(top)}$	Junction-to-case (top) thermal resistance	87.6	$^{\circ}$ C/W
$R_{\theta JB}$	Junction-to-board thermal resistance	36.8	$^{\circ}$ C/W
ψ_{JT}	Junction-to-top characterization parameter	1.8	$^{\circ}$ C/W
ψ_{JB}	Junction-to-board characterization parameter	37.2	$^{\circ}$ C/W
$R_{\theta JC(bot)}$	Junction-to-case (bottom) thermal resistance	7.7	$^{\circ}$ C/W

 (1) For more information about traditional and new thermal metrics, see the *Semiconductor and IC Package Thermal Metrics* application report, [SPRA953](http://www.ti.com/lit/zip/Spra953).

6.5 Electrical Characteristics

Over operating temperature range ($T_J = -40^\circ\text{C}$ to 125°C), $V_{IN} = V_{OUT(nom)} + 1\text{ V}^{(1)}$, $I_{OUT} = 10\text{ mA}$, $V_{EN} = 2.2\text{ V}$, and $C_{OUT} = 2.2\text{ }\mu\text{F}$, unless otherwise noted. Typical values are at $T_J = 25^\circ\text{C}$.

PARAMETER		TEST CONDITIONS	MIN	TYP	MAX	UNIT
V_{IN}	Input voltage range ⁽¹⁾⁽²⁾		2.2		5.5	V
V_{FB}	Internal reference	$T_J = 25^\circ\text{C}$	1.192	1.204	1.216	V
V_{OUT}	Output voltage range	TPS7A3701 ⁽³⁾	V_{FB}		$5.5 - V_{DO}$	V
	Accuracy ^{(1), (4)}	Nominal	$T_J = 25^\circ\text{C}$	0.23%		
over V_{IN} , I_{OUT} , and $T_J = -40^\circ\text{C}$ to 125°C		$V_{OUT} + 0.5\text{ V} \leq V_{IN} \leq 5.5\text{ V}$; $10\text{ mA} \leq I_{OUT} \leq 1\text{ A}$	-1%		+1.0%	
$\Delta V_{O(\Delta V)}$	Line regulation ⁽¹⁾	$V_{OUT(nom)} + 0.5\text{ V} \leq V_{IN} \leq 5.5\text{ V}$		0.01	0.03	%/V
$\Delta V_{O(\Delta I)}$	Load regulation	$0.1\text{ mA} \leq I_{OUT} \leq 300\text{ mA}$		0.25%	0.35%	
		$10\text{ mA} \leq I_{OUT} \leq 1\text{ A}$		3	5	mV
V_{DO}	Dropout voltage ⁽⁵⁾ ($V_{IN} = V_{OUT(nom)} - 0.1\text{ V}$)	$I_{OUT} = 1\text{ A}$		130	200	mV
$Z_O(\text{DO})$	Output impedance in dropout	$2.2\text{ V} \leq V_{IN} \leq V_{OUT} + V_{DO}$		0.25		Ω
I_{CL}	Output current limit	$V_{OUT} = 0.9 \times V_{OUT(nom)}$	1.05	1.6	2.2	A
I_{SC}	Short-circuit current	$V_{OUT} = 0\text{ V}$		450		mA
I_{REV}	Reverse leakage current ⁽⁶⁾ ($-I_{IN}$)	$V_{EN} \leq 0.5\text{ V}$, $0\text{ V} \leq V_{IN} \leq V_{OUT}$		0.1		μA
I_{GND}	GND pin current	$I_{OUT} = 10\text{ mA}$ (I_Q)		400		μA
		$I_{OUT} = 1\text{ A}$		1300		
I_{SHDN}	Shutdown current (I_{GND})	$V_{EN} \leq 0.5\text{ V}$, $V_{OUT} \leq V_{IN} \leq 5.5\text{ V}$		20		nA
I_{FB}	FB pin current	TPS7A3701		0.1	0.6	μA
PSRR	Power-supply rejection ratio (ripple rejection)	$f = 100\text{ Hz}$, $I_{OUT} = 1\text{ A}$		58		dB
		$f = 10\text{ kHz}$, $I_{OUT} = 1\text{ A}$		37		
V_N	Output noise voltage BW = 10 Hz to 100 kHz	$C_{OUT} = 10\text{ }\mu\text{F}$		$27 \times V_{OUT}$		μV_{RMS}
t_{STR}	Startup time	$V_{OUT} = 3\text{ V}$, $R_L = 30\text{ }\Omega$, $C_{OUT} = 1\text{ }\mu\text{F}$		600		μs
$V_{EN(HI)}$	EN pin high (enabled)		1.7		V_{IN}	V
$V_{EN(LO)}$	EN pin low (shutdown)		0		0.5	V
$I_{EN(HI)}$	EN pin current (enabled)	$V_{EN} = 5.5\text{ V}$		20		nA
T_{SD}	Thermal shutdown temperature	Shutdown, temperature increasing		160		$^\circ\text{C}$
		Reset, temperature decreasing		140		
T_J	Operating junction temperature		-40		125	$^\circ\text{C}$

(1) Minimum $V_{IN} = V_{OUT} + V_{DO}$ or 2.2 V, whichever is greater.

(2) For $V_{OUT(nom)} < 1.6\text{ V}$, when $V_{IN} \leq 1.6\text{ V}$, the output will lock to V_{IN} and may result in an over-voltage condition on the output. To avoid this situation, disable the device before powering down V_{IN} .

(3) TPS7A3701 is tested at $V_{OUT} = 1.2\text{ V}$.

(4) Tolerance of external resistors not included in this specification.

(5) V_{DO} is not measured for fixed output versions with $V_{OUT(nom)} < 2.3\text{ V}$ since minimum $V_{IN} = 2.2\text{ V}$.

(6) Fixed-voltage versions only; refer to the [Application Information](#) section for more information.

6.6 Typical Characteristics

For all voltage versions at $T_J = 25^\circ\text{C}$, $V_{IN} = V_{OUT(nom)} + 1\text{ V}$, $I_{OUT} = 10\text{ mA}$, $V_{EN} = 2.2\text{ V}$, and $C_{OUT} = 2.2\text{ }\mu\text{F}$, unless otherwise noted.

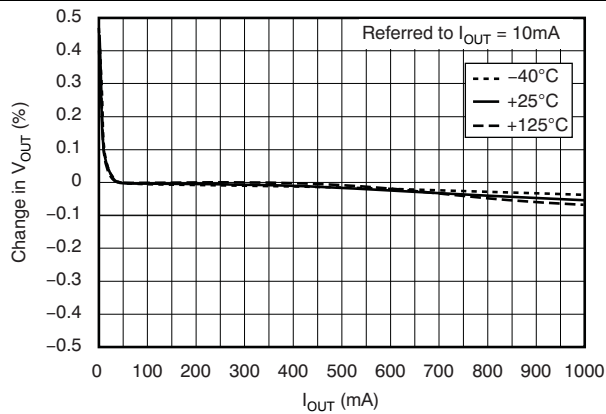

Figure 1. Load Regulation

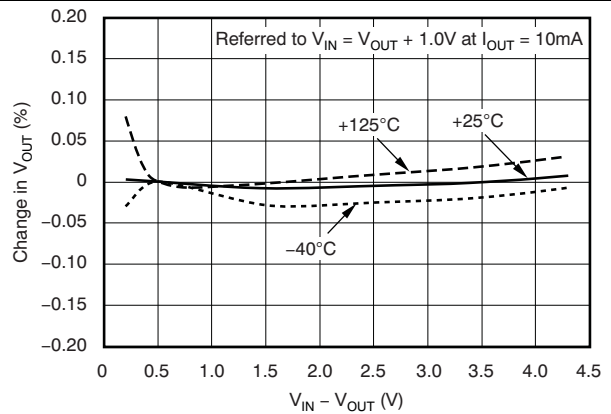

Figure 2. Line Regulation

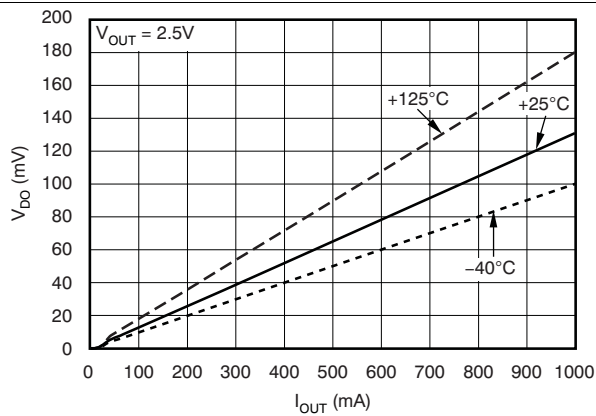

Figure 3. Dropout Voltage vs Output Current

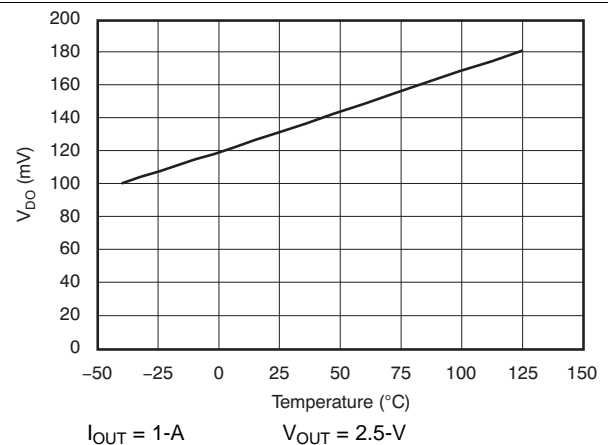

Figure 4. Dropout Voltage vs Temperature

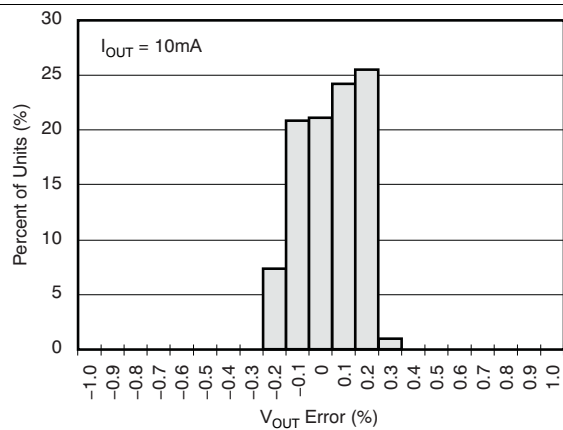

Figure 5. Output Voltage Histogram

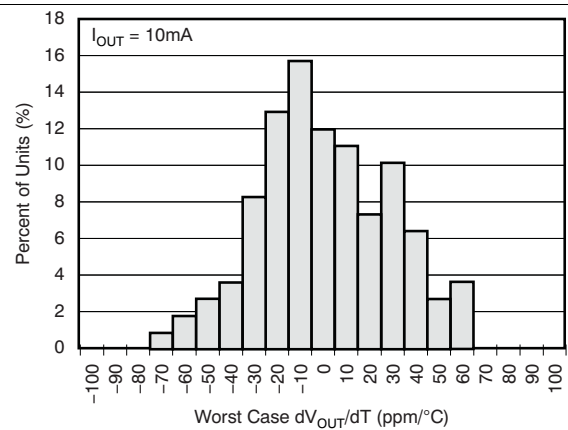

Figure 6. Output Voltage Drift Histogram

Typical Characteristics (continued)

For all voltage versions at $T_J = 25^\circ\text{C}$, $V_{IN} = V_{OUT(nom)} + 1\text{ V}$, $I_{OUT} = 10\text{ mA}$, $V_{EN} = 2.2\text{ V}$, and $C_{OUT} = 2.2\text{ }\mu\text{F}$, unless otherwise noted.

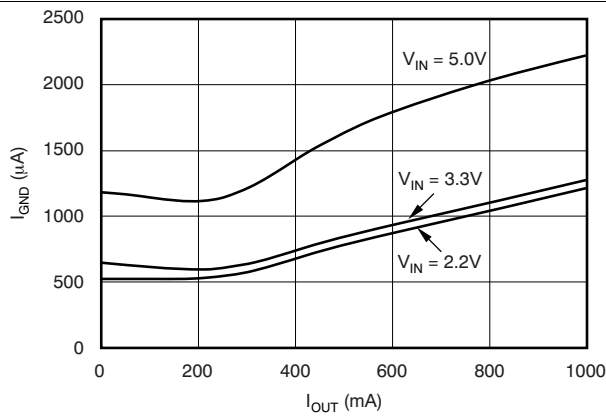

Figure 7. Ground Pin Current vs Output Current

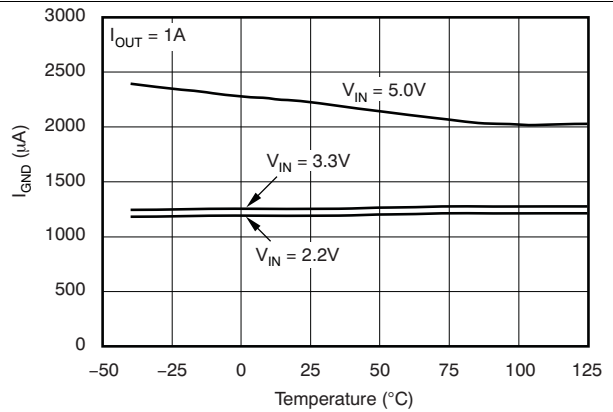

Figure 8. Ground Pin Current vs Temperature

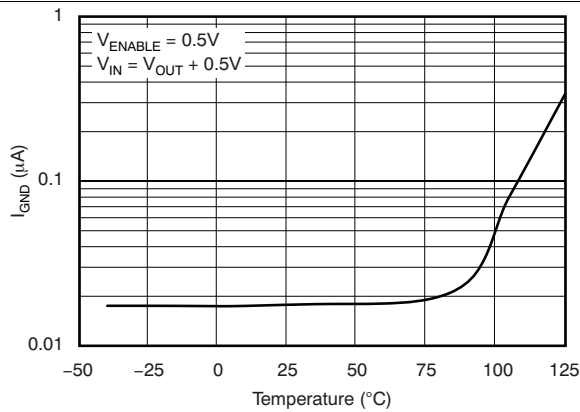

Figure 9. Ground Pin Current in Shutdown vs Temperature

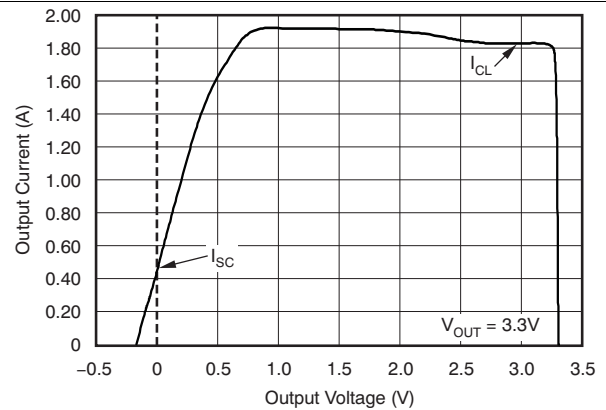

Figure 10. Current Limit vs V_{OUT} (Foldback)

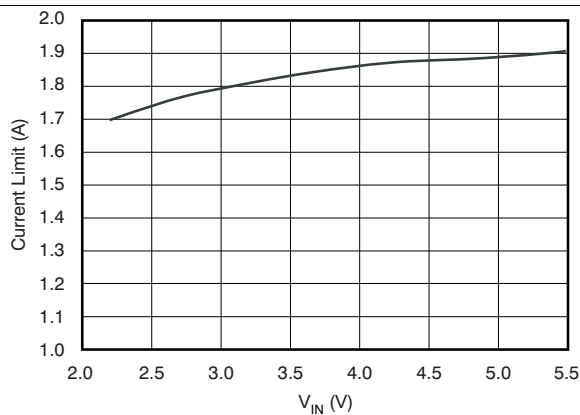

Figure 11. Current Limit vs V_{IN}

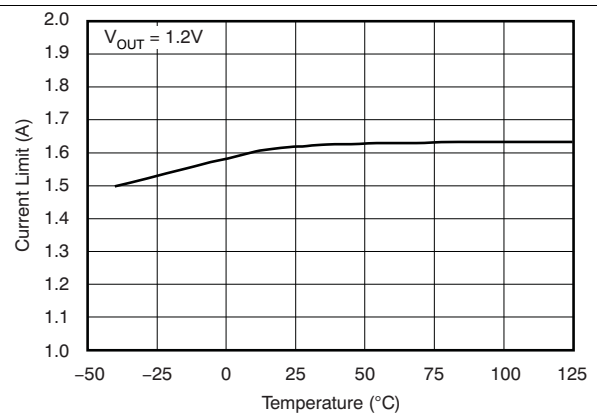

Figure 12. Current Limit vs Temperature

Typical Characteristics (continued)

For all voltage versions at $T_J = 25^\circ\text{C}$, $V_{IN} = V_{OUT(nom)} + 1\text{ V}$, $I_{OUT} = 10\text{ mA}$, $V_{EN} = 2.2\text{ V}$, and $C_{OUT} = 2.2\text{ }\mu\text{F}$, unless otherwise noted.

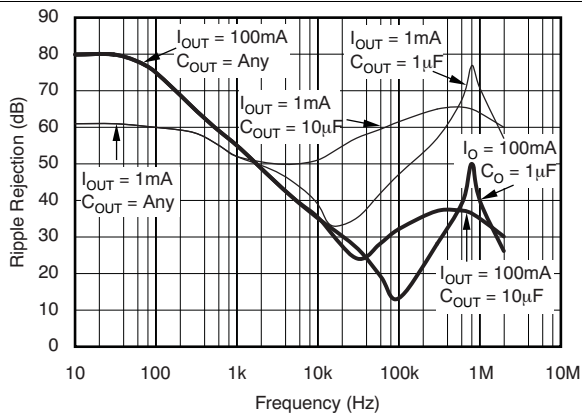

Figure 13. PSRR (Ripple Rejection) vs Frequency

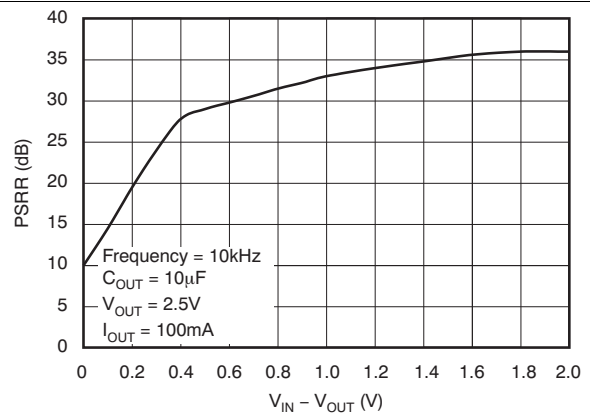

Figure 14. PSRR (Ripple Rejection) vs $V_{IN} - V_{OUT}$

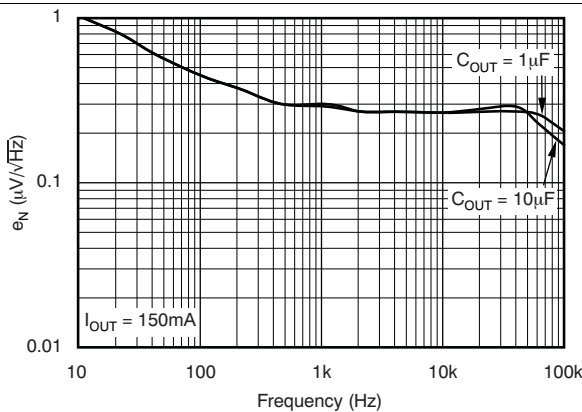

Figure 15. Noise Spectral Density

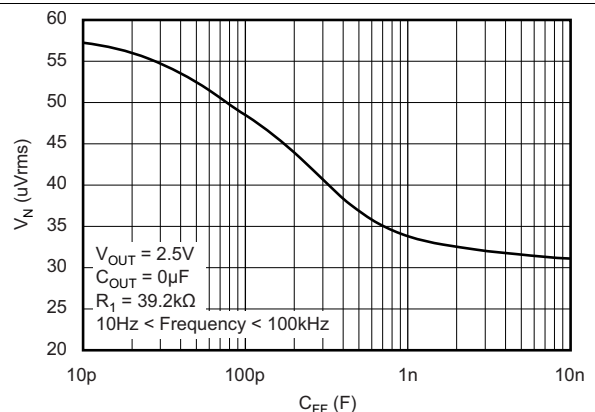

Figure 16. TPS7A3701: RMS Noise Voltage vs C_{FF}

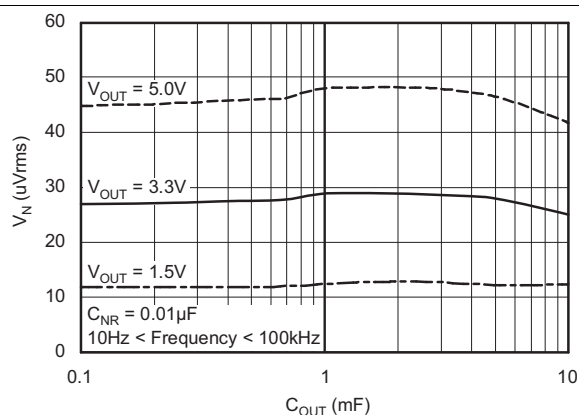

Figure 17. RMS Noise Voltage vs C_{OUT}

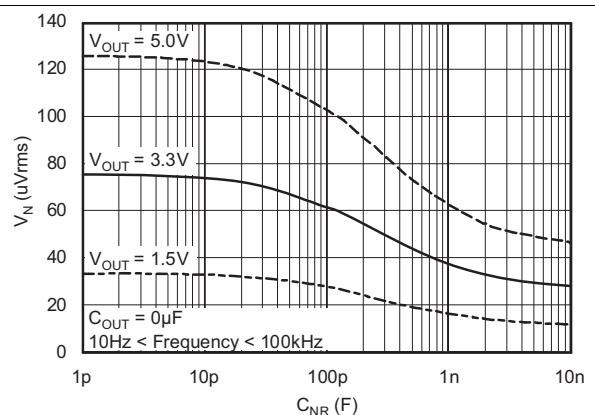
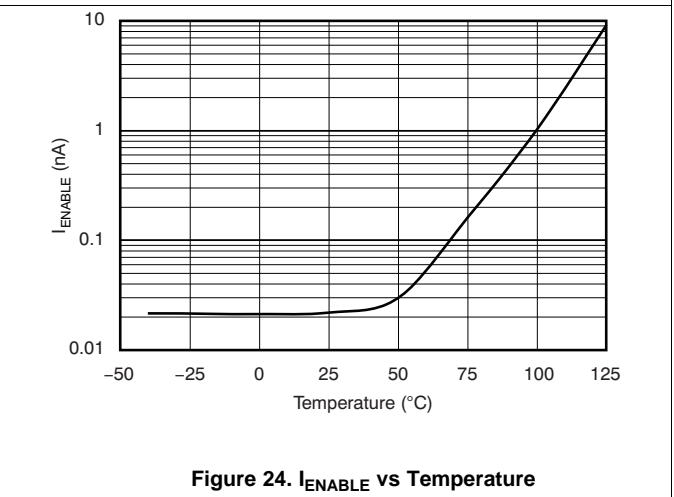
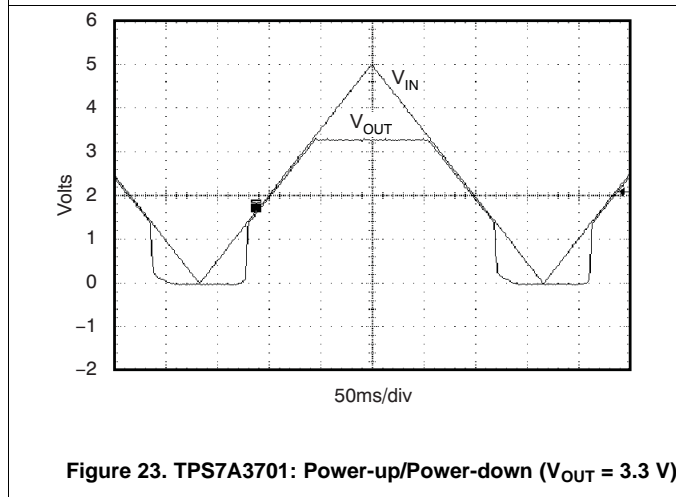
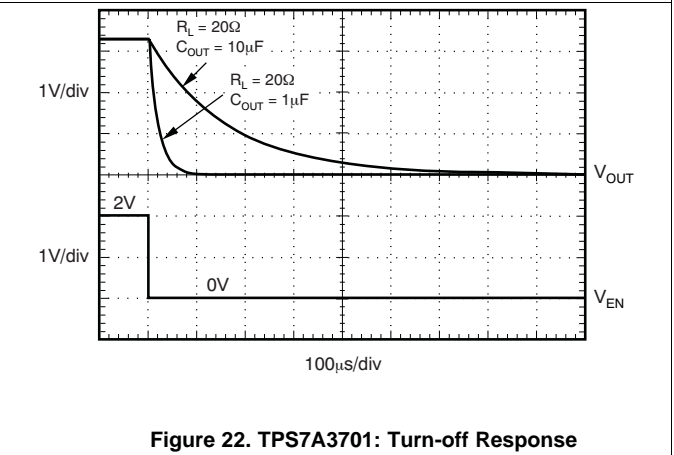
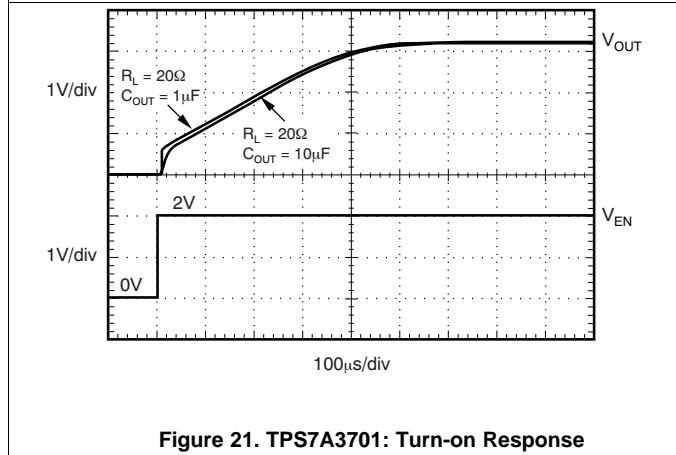
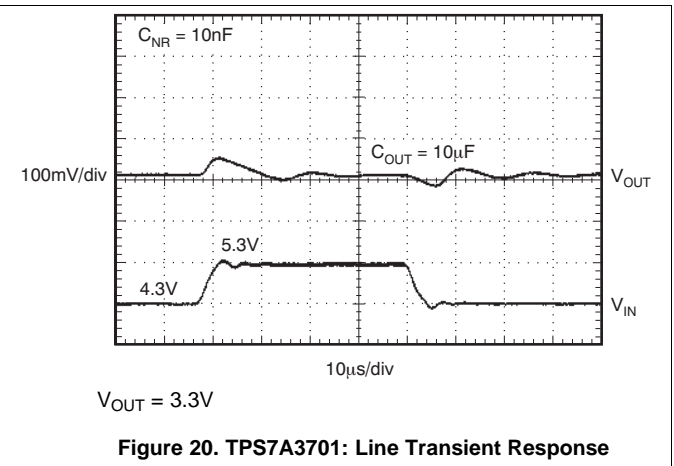
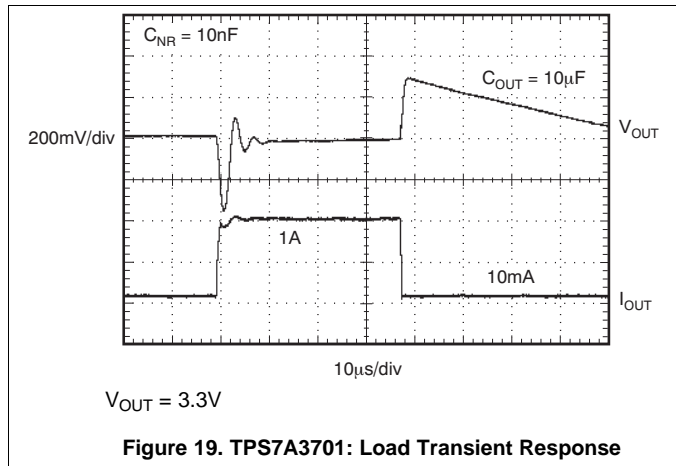

Figure 18. RMS Noise Voltage vs C_{NR}

Typical Characteristics (continued)

For all voltage versions at $T_J = 25^\circ\text{C}$, $V_{IN} = V_{OUT(nom)} + 1\text{ V}$, $I_{OUT} = 10\text{ mA}$, $V_{EN} = 2.2\text{ V}$, and $C_{OUT} = 2.2\text{ }\mu\text{F}$, unless otherwise noted.



Typical Characteristics (continued)

For all voltage versions at $T_J = 25^\circ\text{C}$, $V_{IN} = V_{OUT(nom)} + 1\text{ V}$, $I_{OUT} = 10\text{ mA}$, $V_{EN} = 2.2\text{ V}$, and $C_{OUT} = 2.2\text{ }\mu\text{F}$, unless otherwise noted.

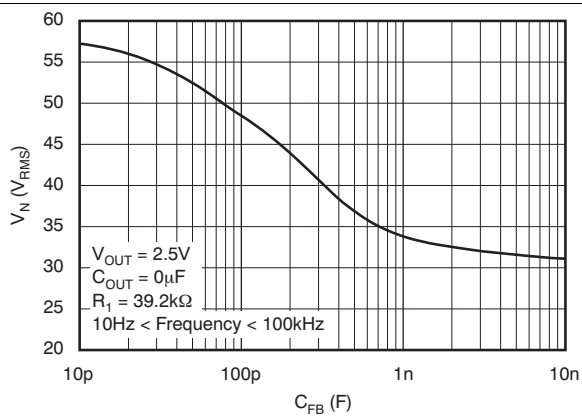

Figure 25. TPS7A3701: RMS Noise Voltage vs C_{FB}

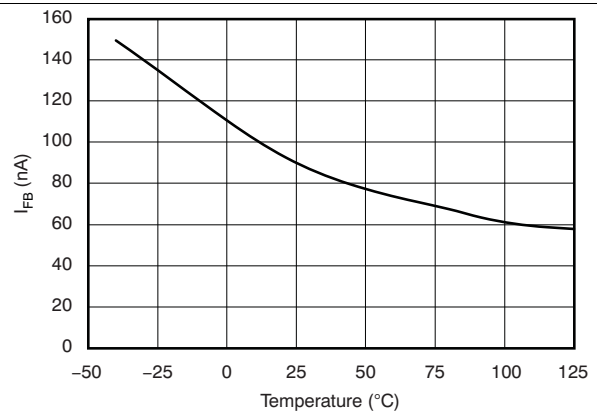

Figure 26. TPS7A3701: I_{FB} vs Temperature

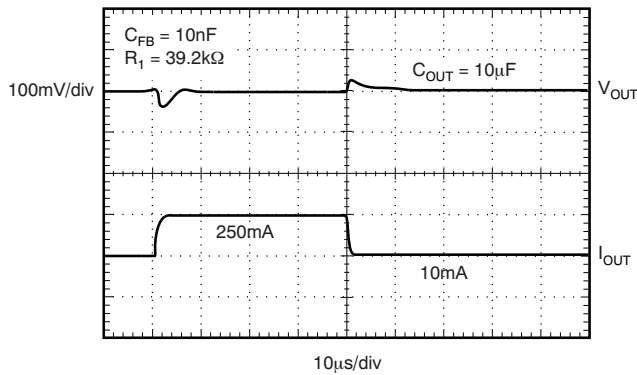

Figure 27. TPS7A3701: Load Transient, Adjustable Version

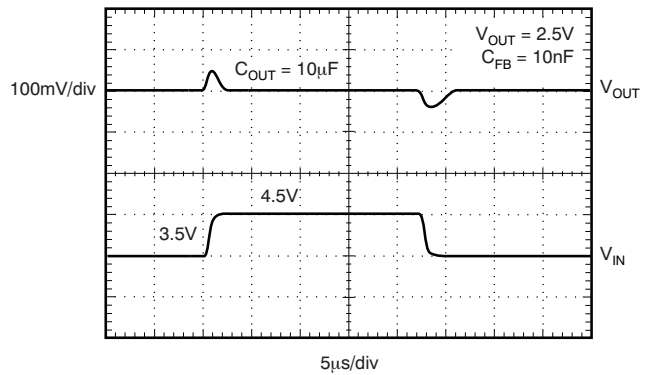

Figure 28. TPS7A3701: Line Transient, Adjustable Version

7 Detailed Description

7.1 Overview

The TPS7A37 belongs to a family of LDO regulators that use an NMOS pass transistor to achieve ultra-low-dropout performance and reverse current protection. These features combined with an enable input make the TPS7A37 ideal for portable applications. This regulator family offers a wide selection of fixed output voltage versions and an adjustable output version. All versions have thermal and over-current protection, including foldback current limit.

7.2 Functional Block Diagrams

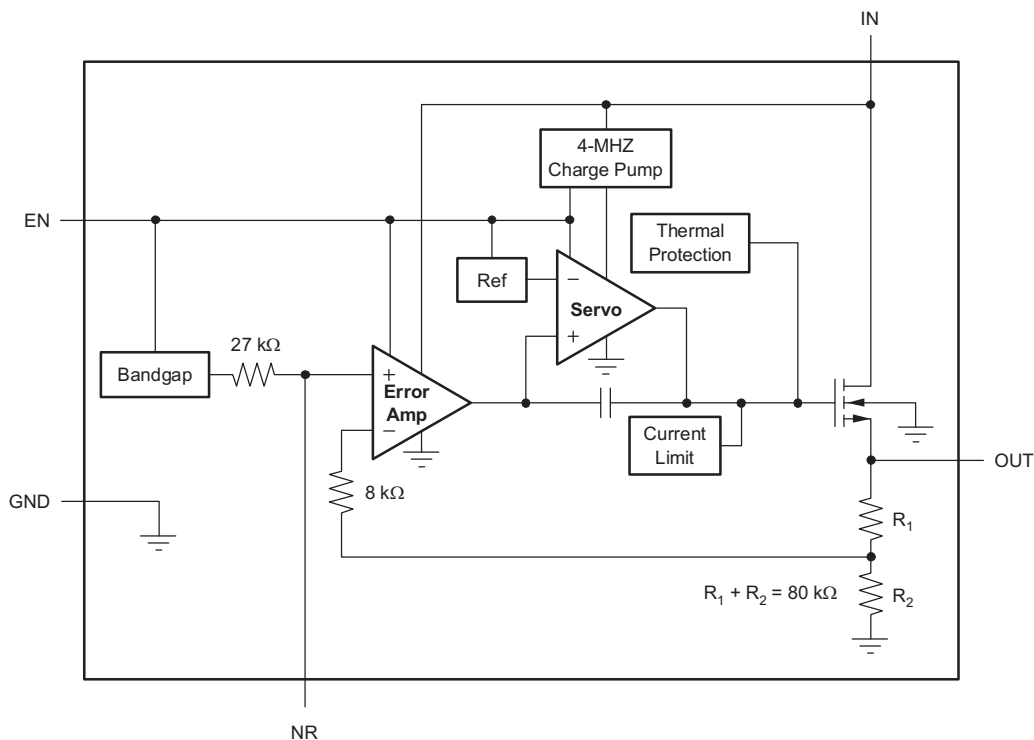
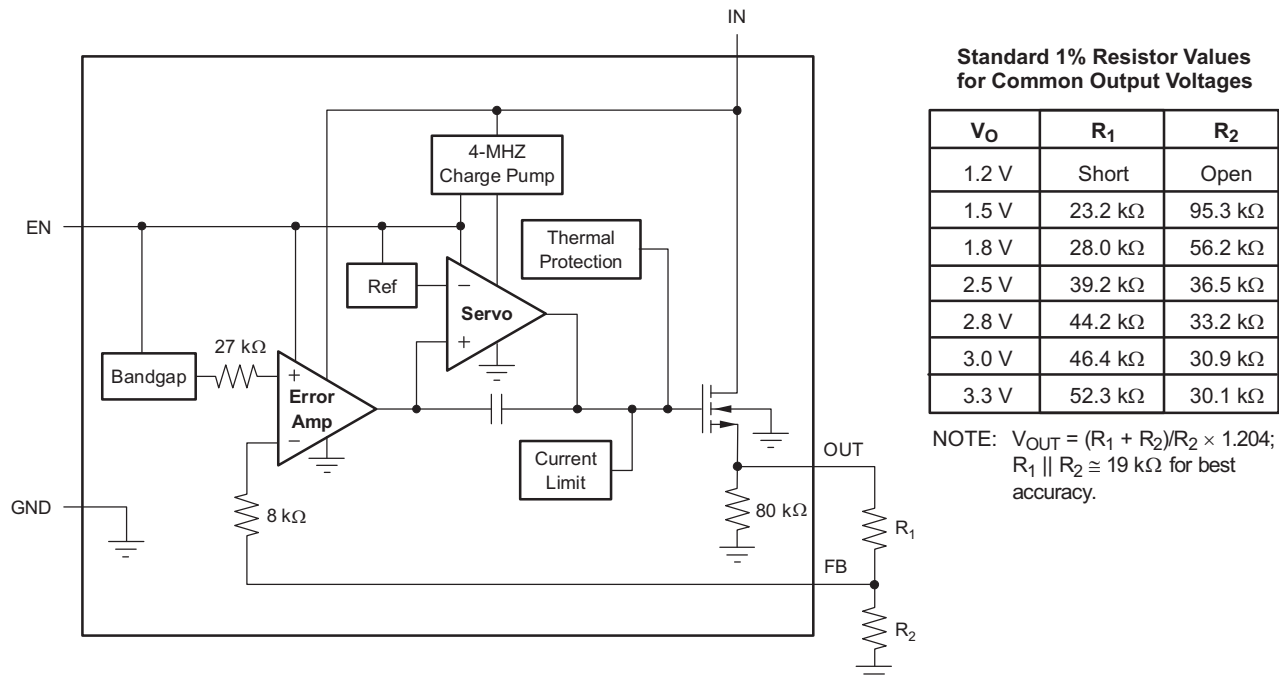

Figure 29. Fixed Voltage Version

Functional Block Diagrams (continued)

Figure 30. Adjustable Voltage Version

7.3 Feature Description

7.3.1 Internal Current Limit

The TPS7A37 internal current limit helps protect the regulator during fault conditions. Foldback current limit helps to protect the regulator from damage during output short-circuit conditions by reducing current limit when V_{OUT} drops below 0.5 V. See [Figure 10](#) in the *Typical Characteristics* section.

Note from [Figure 10](#) that approximately -0.2 V of V_{OUT} results in a current limit of 0 mA. Therefore, if OUT is forced below -0.2 V before EN goes high, the device may not start up. In applications that work with both a positive and negative voltage supply, the TPS7A37 should be enabled first.

7.3.2 Enable Pin and Shutdown

The enable pin (EN) is active high and is compatible with standard TTL-CMOS levels. A V_{EN} below 0.5 V (max) turns the regulator off and drops the GND pin current to approximately 10 nA. When EN is used to shutdown the regulator, all charge is removed from the pass transistor gate, and the output ramps back up to a regulated V_{OUT} (see [Figure 21](#)).

When shutdown capability is not required, EN can be connected to V_{IN} . However, the pass gate may not be discharged using this configuration, and the pass transistor may be left on (enhanced) for a significant time after V_{IN} has been removed. This scenario can result in reverse current flow (if the IN pin is low impedance) and faster ramp times upon power-up. In addition, for V_{IN} ramp times slower than a few milliseconds, the output may overshoot upon power-up.

Note that current limit foldback can prevent device start-up under some conditions. See the [Internal Current Limit](#) section for more information.

Feature Description (continued)

7.3.3 Reverse Current

The NMOS pass element of the TPS7A37 provides inherent protection against current flow from the output of the regulator to the input when the gate of the pass device is pulled low. To ensure that all charge is removed from the gate of the pass element, the EN pin must be driven low before the input voltage is removed. If this is not done, the pass element may be left on because of stored charge on the gate.

After the EN pin is driven low, no bias voltage is needed on any pin for reverse current blocking. Note that reverse current is specified as the current flowing out of the IN pin because of voltage applied on the OUT pin. There will be additional current flowing into the OUT pin as a result of the 80-k Ω internal resistor divider to ground (see [Figure 29](#) and [Figure 30](#)).

For the TPS7A3701, reverse current may flow when V_{FB} is more than 1.0 V above V_{IN} .

7.4 Device Functional Modes

Driving the EN pin over 1.7 V turns on the regulator. Driving the EN pin below 0.5 V causes the regulator to enter shutdown mode. In shutdown, the current consumption of the device is reduced to 20 nA, typically.

8 Application and Implementation

NOTE

Information in the following applications sections is not part of the TI component specification, and TI does not warrant its accuracy or completeness. TI's customers are responsible for determining suitability of components for their purposes. Customers should validate and test their design implementation to confirm system functionality.

8.1 Application Information

8.1.1 Input and Output Capacitor Requirements

Although an input capacitor is not required for stability if input impedance is very low, it is good analog design practice to connect a 0.1- μ F to 1- μ F low equivalent series resistance (ESR) capacitor across the input supply near the regulator. This capacitor counteracts reactive input sources and improves transient response, noise rejection, and ripple rejection. A higher-value capacitor may be necessary if large, fast rise-time load transients are anticipated or the device is located several inches from the power source.

The TPS7A37 requires a 1- μ F output capacitor for stability. It is designed to be stable for all available types and values of capacitors. In applications where multiple low ESR capacitors are in parallel, ringing may occur when $C_{OUT} \times ESR < 50 \text{ n}\Omega\text{-F}$. Total ESR includes all parasitic resistances, including capacitor ESR and board, socket, and solder joint resistance. In most applications, the sum of capacitor ESR and trace resistance will meet this requirement.

8.1.2 Output Noise

A precision bandgap reference is used to generate the internal reference voltage, V_{REF} . This reference is the dominant noise source within the TPS7A37 and it generates approximately $32 \mu\text{V}_{RMS}$ (10 Hz to 100 kHz) at the reference output (NR). The regulator control loop gains up the reference noise with the same gain as the reference voltage, so that the noise voltage of the regulator is approximately given by:

$$V_N = 32\mu\text{V}_{RMS} \times \frac{(R_1 + R_2)}{R_2} = 32\mu\text{V}_{RMS} \times \frac{V_{OUT}}{V_{REF}} \quad (1)$$

Since the value of V_{REF} is 1.2V, this relationship reduces to:

$$V_N(\mu\text{V}_{RMS}) = 27 \left(\frac{\mu\text{V}_{RMS}}{V} \right) \times V_{OUT}(V) \quad (2)$$

for the case of no C_{NR} .

An internal 27-k Ω resistor in series with the noise reduction pin (NR) forms a low-pass filter for the voltage reference when an external noise reduction capacitor, C_{NR} , is connected from NR to ground. For $C_{NR} = 10 \text{ nF}$, the total noise in the 10-Hz to 100-kHz bandwidth is reduced by a factor of ~ 3.2 , giving the approximate relationship:

$$V_N(\mu\text{V}_{RMS}) = 8.5 \left(\frac{\mu\text{V}_{RMS}}{V} \right) \times V_{OUT}(V) \quad (3)$$

for $C_{NR} = 10 \text{ nF}$.

This noise reduction effect is shown as RMS Noise Voltage vs C_{NR} in the [Typical Characteristics](#) section.

The TPS7A3701 adjustable version does not have the NR pin available. However, connecting a feedback capacitor, C_{FB} , from the output to the feedback pin (FB) reduces output noise and improve load transient performance. This capacitor should be limited to 0.1 μ F.

The TPS7A37 uses an internal charge pump to develop an internal supply voltage sufficient to drive the gate of the NMOS pass element above V_{OUT} . The charge pump generates $\sim 250 \mu\text{V}$ of switching noise at $\sim 4 \text{ MHz}$; however, charge-pump noise contribution is negligible at the output of the regulator for most values of I_{OUT} and C_{OUT} .

Application Information (continued)

8.1.3 Dropout Voltage

The TPS7A37 uses an NMOS pass transistor to achieve extremely low dropout. When $(V_{IN} - V_{OUT})$ is less than the dropout voltage (V_{DO}), the NMOS pass device is in its linear region of operation and the input-to-output resistance is the $R_{DS, ON}$ of the NMOS pass element.

For large step changes in load current, the TPS7A37 requires a larger voltage drop from V_{IN} to V_{OUT} to avoid degraded transient response. The boundary of this transient dropout region is approximately twice the dc dropout. Values of $V_{IN} - V_{OUT}$ above this line ensure normal transient response.

Operating in the transient dropout region can cause an increase in recovery time. The time required to recover from a load transient is a function of the magnitude of the change in load current rate, the rate of change in load current, and the available headroom (V_{IN} to V_{OUT} voltage drop). Under worst-case conditions [full-scale instantaneous load change with $(V_{IN} - V_{OUT})$ close to dc dropout levels], the TPS7A37 can take a couple of hundred microseconds to return to the specified regulation accuracy.

8.1.4 Transient Response

The low open-loop output impedance provided by the NMOS pass element in a voltage follower configuration allows operation without a 1.0- μ F output capacitor. As with any regulator, the addition of additional capacitance from the OUT pin to ground reduces undershoot magnitude but increases its duration. In the adjustable version, the addition of a capacitor, C_{FB} , from the OUT pin to the FB pin will also improve the transient response.

The TPS7A37 does not have active pull-down when the output is over-voltage. This architecture allows applications that connect higher voltage sources, such as alternate power supplies, to the output. This architecture also results in an output overshoot of several percent if the load current quickly drops to zero when a capacitor is connected to the output. The duration of overshoot can be reduced by adding a load resistor. The overshoot decays at a rate determined by output capacitor C_{OUT} and the internal/external load resistance. The rate of decay is given by:

(Fixed voltage version)

$$\frac{dV}{dT} = \frac{V_{OUT}}{C_{OUT} \times 80k\Omega \parallel R_{LOAD}} \quad (4)$$

(Adjustable voltage version)

$$\frac{dV}{dT} = \frac{V_{OUT}}{C_{OUT} \times 80k\Omega \parallel (R_1 + R_2) \parallel R_{LOAD}} \quad (5)$$

8.2 Typical Applications

8.2.1 Typical Application Schematic

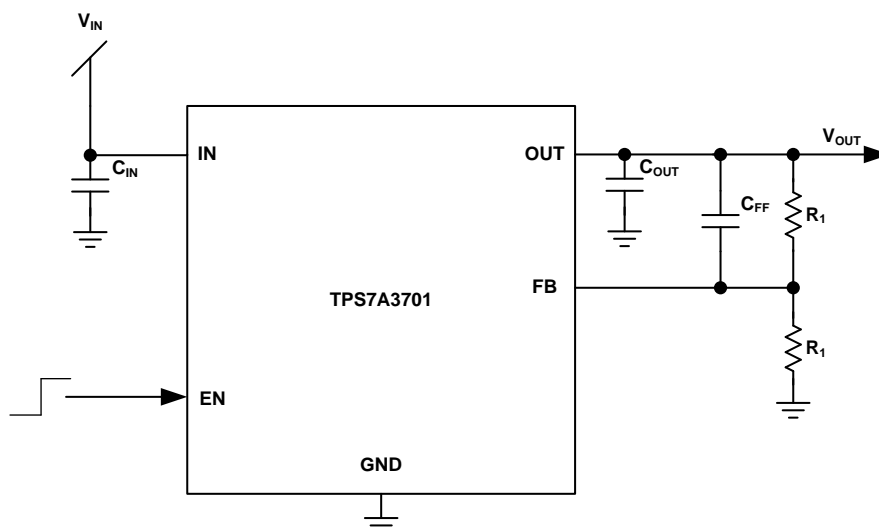

Figure 31. Typical Application Schematic

8.2.1.1 Design Requirements

Table 1 lists the design parameters.

Table 1. Design Parameters

DESIGN PARAMETER	EXAMPLE VALUE
Input voltage	3.6 V
Output voltage	3.3 V
DC output current	100 mA
Peak output current	1 A

8.2.1.2 Detailed Design Procedure

Due to the transients in this application input and output capacitors should be used. A $C_{IN} = C_{OUT} = 10\text{-}\mu\text{F}$ capacitor has been selected.

The ESR of the chosen capacitor can be checked by looking the magnitude of the complex impedance over frequency. When $|Z_c|$ reaches a minimum the DC ESR is the value of $|Z_c|$ at that frequency. The ESR of the chosen capacitor is $10\text{ m}\Omega$, which gives us a product of $10\text{ m}\Omega \times 10\text{ }\mu\text{F} = 100\text{ n}\Omega\text{-F} > 50\text{ n}\Omega\text{-F}$, minimizing the ringing during transients.

As the $V_{IN} - V_{OUT}$ change is only 300 mV with a 100-mA DC current, the expected junction temperature rise over the ambient, on a JEDEC standard board, is $67.2\text{ C/W} \times 0.3\text{ V} \times 0.1\text{ A} = 2\text{ C}$.

To ensure best accuracy, $R_1 = 52.3\text{ k}\Omega$ and $R_2 = 30.1\text{ k}\Omega$, and a $10\text{-nF } C_{FF}$ is used to reduce output noise.

8.2.1.3 Application Curves

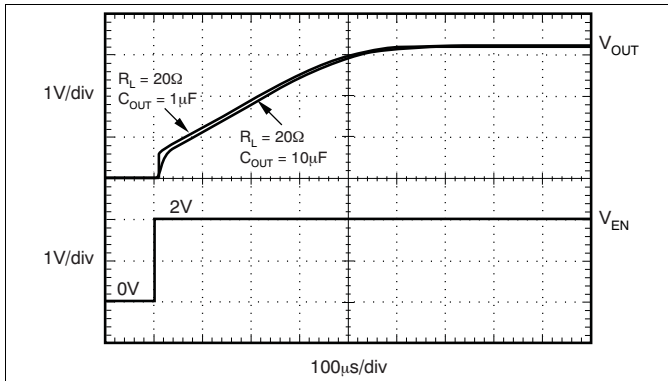

Figure 32. TPS7A3701: Turn-on Response

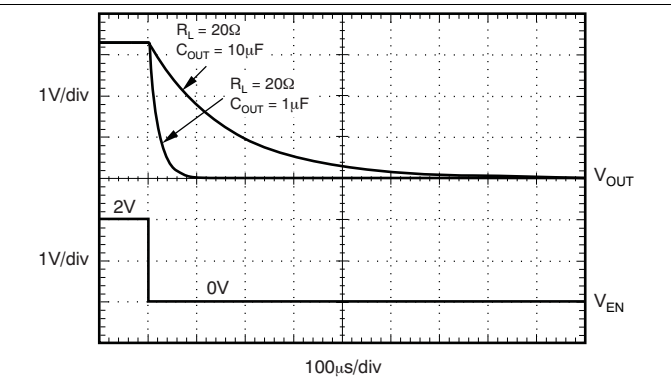

Figure 33. TPS7A3701: Turn-off Response

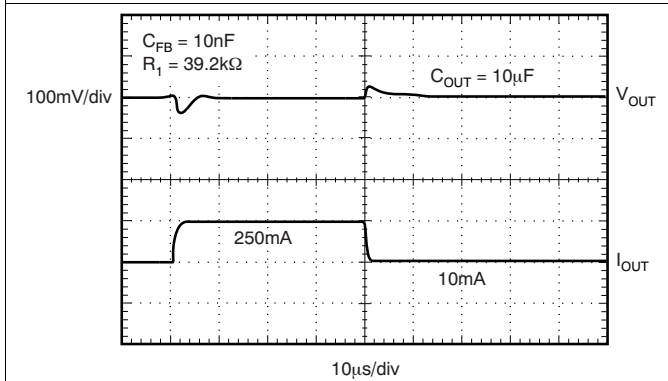

Figure 34. TPS7A3701: Load Transient, Adjustable Version

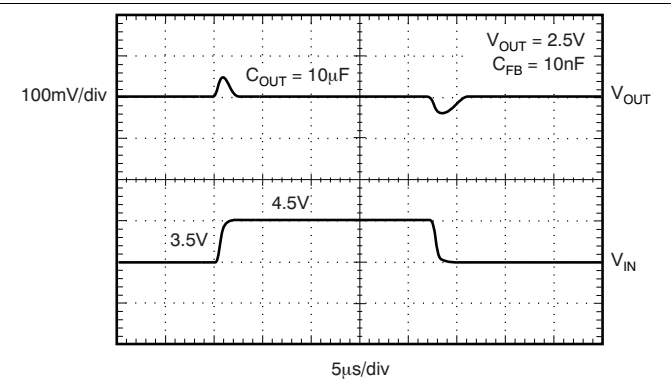

Figure 35. TPS7A3701: Line Transient, Adjustable Version

8.2.2 Fixed-Voltage Version

Figure 36 shows the basic circuit connections for the fixed voltage models.

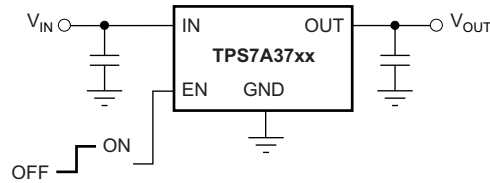

Figure 36. Typical Application Circuit for Fixed-Voltage Version

8.2.3 Adjustable Operation

Figure 37 gives the connections for the adjustable output version, TPS7A3701 ⁽¹⁾.

R_1 and R_2 can be calculated for any output voltage using the formula shown in Figure 37. Sample resistor values for common output voltages are shown in Figure 30.

For best accuracy, make the parallel combination of R_1 and R_2 approximately equal to 19 k Ω . This 19 k Ω , in addition to the internal 8-k Ω resistor, presents the same impedance to the error amp as the 27-k Ω bandgap reference output. This impedance helps compensate for leakages into the error amp terminals.

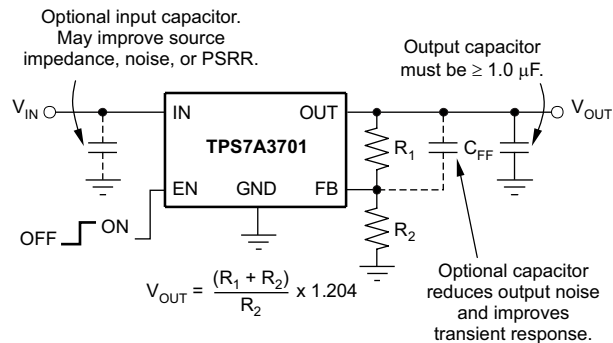

Figure 37. Typical Application Circuit for Adjustable-Voltage Version⁽¹⁾

(1) Product-preview device.

9 Power Supply Recommendations

The input supply for the LDO must be within its recommended operating conditions (that is, between 2.2 V to 5.5 V). The input voltage must provide adequate headroom in order for the device to have a regulated output. If the input supply is noisy, additional input capacitors with low ESR can help improve the output transient performance.

10 Layout

10.1 Layout Guidelines

Layout is a critical part of good power-supply design. There are several signal paths that conduct fast-changing currents or voltages that can interact with stray inductance or parasitic capacitance to generate noise or degrade the power-supply performance. To help eliminate these problems, the IN pin should be bypassed to ground with a low ESR ceramic bypass capacitor with an X5R or X7R dielectric.

The GND pin should be tied directly to the PowerPAD under the IC. The PowerPAD should be connected to any internal PCB ground planes using multiple vias directly under the IC.

Do not place any of the capacitors on the opposite side of the PCB from where the regulator is installed. The use of vias and long traces is strongly discouraged because these circuits may impact system performance negatively, and even cause instability.

10.1.1 Board Layout Recommendations to Improve PSRR and Noise Performance

To improve AC performance (such as PSRR, output noise, and transient response), TI recommends designing the board with separate ground planes for V_{IN} and V_{OUT} , with each ground plane star connected only at the GND pin of the device.

10.2 Layout Example

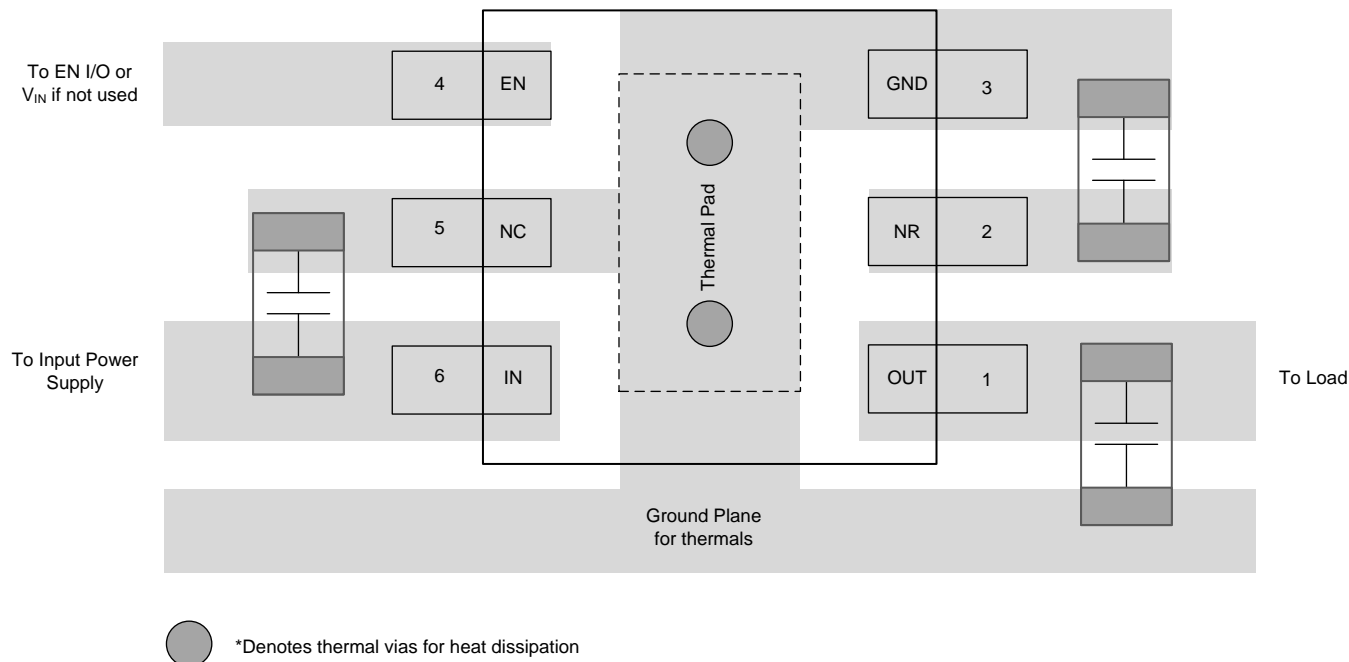

Figure 38. Fixed Voltage Layout

Layout Example (continued)

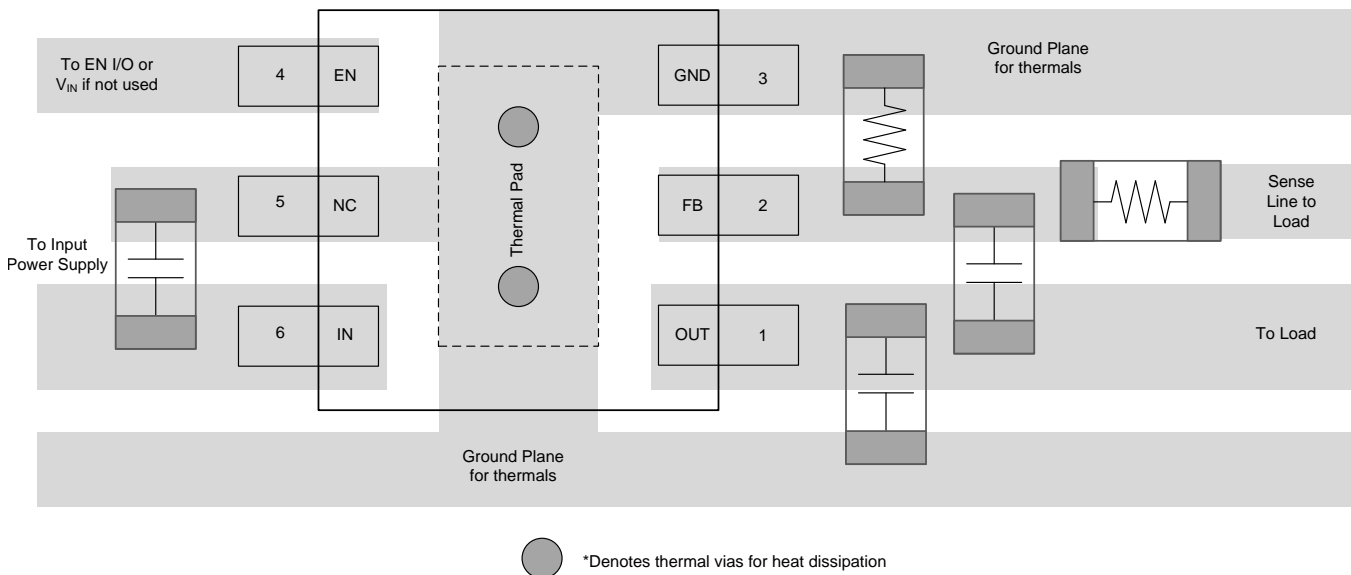

Figure 39. Adjustable Voltage Layout

10.3 Thermal Considerations

Thermal protection disables the output when the junction temperature rises to approximately +160°C, allowing the device to cool. When the junction temperature cools to approximately +140°C, the output circuitry is again enabled. Depending on power dissipation, thermal resistance, and ambient temperature, the thermal protection circuit may cycle on and off. This cycling limits the dissipation of the regulator, protecting it from damage due to overheating.

Any tendency to activate the thermal protection circuit indicates excessive power dissipation or an inadequate heatsink. For reliable operation, junction temperature should be limited to +125°C maximum. To estimate the margin of safety in a complete design (including heatsink), increase the ambient temperature until the thermal protection is triggered; use worst-case loads and signal conditions. For good reliability, thermal protection should trigger at least +35°C above the maximum expected ambient condition of your application. This produces a worst-case junction temperature of +125°C at the highest expected ambient temperature and worst-case load.

The internal protection circuitry of the TPS7A37 has been designed to protect against overload conditions. It was not intended to replace proper heatsinking. Continuously running the TPS7A37 into thermal shutdown degrades device reliability.

10.4 Power Dissipation

Knowing the device power dissipation and proper sizing of the thermal plane that is connected to the tab or pad is critical to avoiding thermal shutdown and ensuring reliable operation.

Power dissipation of the device depends on input voltage and load conditions and can be calculated using Equation 6:

$$P_D = (V_{IN} - V_{OUT}) \times I_{OUT} \quad (6)$$

Power dissipation can be minimized and greater efficiency can be achieved by using the lowest possible input voltage necessary to achieve the required output voltage regulation.

Power Dissipation (continued)

On the WSON (DRV) package, the primary conduction path for heat is through the exposed pad to the printed circuit board (PCB). The pad can be connected to ground or be left floating; however, it should be attached to an appropriate amount of copper PCB area to ensure the device does not overheat. That tab should be connected to ground. The maximum junction-to-ambient thermal resistance depends on the maximum ambient temperature, maximum device junction temperature, and power dissipation of the device and can be calculated using Equation 7:

$$R_{\theta JA} = \frac{(+125^{\circ}\text{C} - T_A)}{P_D} \quad (7)$$

Knowing the maximum $R_{\theta JA}$, the minimum amount of PCB copper area needed for appropriate heatsinking can be estimated using Figure 40.

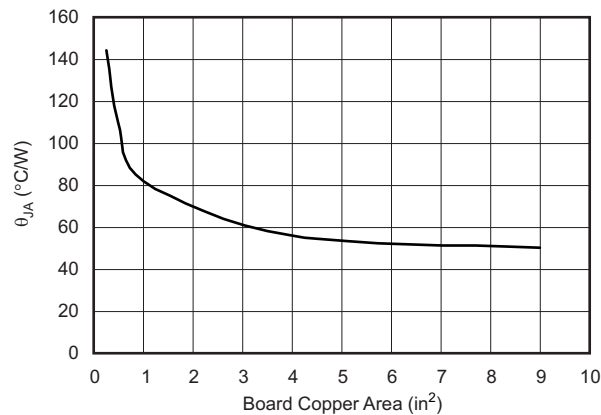

Note: θ_{JA} value at board size of 9in^2 (that is, $3\text{in} \times 3\text{in}$) is a JEDEC standard.

Figure 40. DRV (WSON) Package θ_{JA} vs Board Size

Figure 40 shows the variation of θ_{JA} as a function of ground plane copper area in the board. It is intended only as a guideline to demonstrate the effects of heat spreading in the ground plane and should not be used to estimate actual thermal performance in real application environments.

NOTE

When the device is mounted on an application PCB, it is strongly recommended to use Ψ_{JT} and Ψ_{JB} , as explained in the [Estimating Junction Temperature](#) section.

10.5 Estimating Junction Temperature

Using the thermal metrics Ψ_{JT} and Ψ_{JB} , as shown in the [Thermal Information](#) table, the junction temperature can be estimated with corresponding formulas (given in Equation 8). For backwards compatibility, an older $\theta_{JC,Top}$ parameter is listed as well.

$$\begin{aligned} \Psi_{JT}: T_J &= T_T + \Psi_{JT} \cdot P_D \\ \Psi_{JB}: T_J &= T_B + \Psi_{JB} \cdot P_D \end{aligned} \quad (8)$$

Where P_D is the power dissipation shown by Equation 6, T_T is the temperature at the center-top of the IC package, and T_B is the PCB temperature measured 1mm away from the IC package *on the PCB surface* (as Figure 42 shows).

NOTE

Both T_T and T_B can be measured on actual application boards using a thermo-gun (an infrared thermometer).

Estimating Junction Temperature (continued)

For more information about measuring T_T and T_B , see the application note [SBVA025](#), *Using New Thermal Metrics*, available for download at www.ti.com.

By looking at [Figure 41](#), the new thermal metrics (Ψ_{JT} and Ψ_{JB}) have very little dependency on board size. That is, using Ψ_{JT} or Ψ_{JB} with [Equation 8](#) is a good way to estimate T_J by simply measuring T_T or T_B , regardless of the application board size.

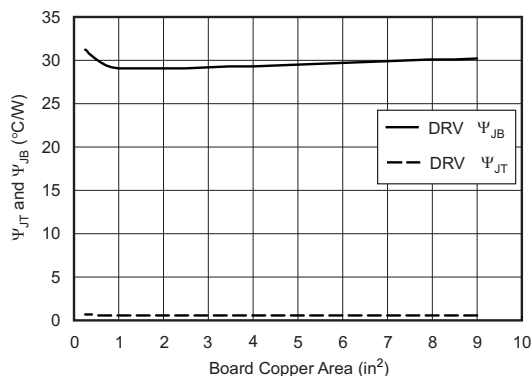
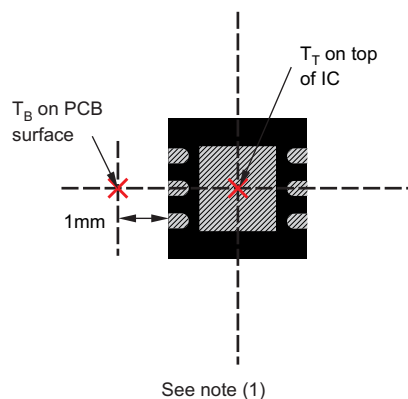

Figure 41. DRV (WSON) Package Ψ_{JT} and Ψ_{JB} vs Board Size

For a more detailed discussion of why TI does not recommend using $\theta_{JC(top)}$ to determine thermal characteristics, refer to application report [SBVA025](#), *Using New Thermal Metrics*, available for download at www.ti.com. For further information, refer to application report [SPRA953](#), *Semiconductor and IC Package Thermal Metrics*, also available on the TI website.



- (1) Power dissipation may limit operating range. Check [Thermal Information](#) table.
- (2) Example DRV (SON) Package Measurement

Figure 42. Measuring Points for T_T and T_B

11 器件和文档支持

11.1 文档支持

11.1.1 相关文档

- 《使用新的热指标》，[SBVA025](#)
- 《TPS7A37xxEVM-529 评估模块》，[SLVU850](#)

11.1.2 社区资源

The following links connect to TI community resources. Linked contents are provided "AS IS" by the respective contributors. They do not constitute TI specifications and do not necessarily reflect TI's views; see TI's [Terms of Use](#).

TI E2E™ Online Community *TI's Engineer-to-Engineer (E2E) Community*. Created to foster collaboration among engineers. At [e2e.ti.com](#), you can ask questions, share knowledge, explore ideas and help solve problems with fellow engineers.

Design Support *TI's Design Support* Quickly find helpful E2E forums along with design support tools and contact information for technical support.

11.2 商标

E2E is a trademark of Texas Instruments.
All other trademarks are the property of their respective owners.

11.3 静电放电警告



这些装置包含有限的内置 ESD 保护。存储或装卸时，应将导线一起截短或将装置放置于导电泡棉中，以防止 MOS 门极遭受静电损伤。

11.4 Glossary

[SLYZ022](#) — *TI Glossary*.

This glossary lists and explains terms, acronyms, and definitions.

12 机械、封装和可订购信息

以下页中包括机械、封装和可订购信息。这些信息是针对指定器件可提供的最新数据。这些数据会在无通知且不对本文档进行修订的情况下发生改变。要获得这份数据表的浏览器版本，请查阅左侧的导航栏。

重要声明

德州仪器(TI)及其下属子公司有权根据 JESD46 最新标准,对所提供的产品和服务进行更正、修改、增强、改进或其它更改,并有权根据 JESD48 最新标准中止提供任何产品和服务。客户在下订单前应获取最新的相关信息,并验证这些信息是否完整且是最新的。所有产品的销售都遵循在订单确认时所提供的TI 销售条款与条件。

TI 保证其所销售的组件的性能符合产品销售时 TI 半导体产品销售条件与条款的适用规范。仅在 TI 保证的范围内,且 TI 认为有必要时才会使用测试或其它质量控制技术。除非适用法律做出了硬性规定,否则没有必要对每种组件的所有参数进行测试。

TI 对应用帮助或客户产品设计不承担任何义务。客户应对其使用 TI 组件的产品和应用自行负责。为尽量减小与客户产品和应用相关的风险,客户应提供充分的设计与操作安全措施。

TI 不对任何 TI 专利权、版权、屏蔽作品权或其它与使用了 TI 组件或服务的组合设备、机器或流程相关的 TI 知识产权中授予的直接或隐含权限作出任何保证或解释。TI 所发布的与第三方产品或服务有关的信息,不能构成从 TI 获得使用这些产品或服务的许可、授权、或认可。使用此类信息可能需要获得第三方的专利权或其它知识产权方面的许可,或是 TI 的专利权或其它知识产权方面的许可。

对于 TI 的产品手册或数据表中 TI 信息的重要部分,仅在没有对内容进行任何篡改且带有相关授权、条件、限制和声明的情况下才允许进行复制。TI 对此类篡改过的文件不承担任何责任或义务。复制第三方的信息可能需要服从额外的限制条件。

在转售 TI 组件或服务时,如果对该组件或服务参数的陈述与 TI 标明的参数相比存在差异或虚假成分,则会失去相关 TI 组件或服务的所有明示或暗示授权,且这是不正当的、欺诈性商业行为。TI 对任何此类虚假陈述均不承担任何责任或义务。

客户认可并同意,尽管任何应用相关信息或支持仍可能由 TI 提供,但他们将独立负责满足与其产品及其在应用中使用的 TI 产品相关的所有法律、法规和安全相关要求。客户声明并同意,他们具备制定与实施安全措施所需的全部专业技术和知识,可预见故障的危险后果、监测故障及其后果、降低有可能造成人身伤害的故障的发生机率并采取适当的补救措施。客户将全额赔偿因在此类安全关键应用中使用任何 TI 组件而对 TI 及其代理造成的任何损失。

在某些场合中,为了推进安全相关应用有可能对 TI 组件进行特别的促销。TI 的目标是利用此类组件帮助客户设计和创立其特有的可满足适用的功能安全性标准和要求的终端产品解决方案。尽管如此,此类组件仍然服从这些条款。

TI 组件未获得用于 FDA Class III (或类似的生命攸关医疗设备)的授权许可,除非各方授权官员已经达成了专门管控此类使用的特别协议。

只有那些 TI 特别注明属于军用等级或“增强型塑料”的 TI 组件才是设计或专门用于军事/航空应用或环境的。购买者认可并同意,对并非指定面向军事或航空航天用途的 TI 组件进行军事或航空航天方面的应用,其风险由客户单独承担,并且由客户独立负责满足与此类使用相关的所有法律和法规要求。

TI 已明确指定符合 ISO/TS16949 要求的产品,这些产品主要用于汽车。在任何情况下,因使用非指定产品而无法达到 ISO/TS16949 要求, TI 不承担任何责任。

	产品		应用
数字音频	www.ti.com.cn/audio	通信与电信	www.ti.com.cn/telecom
放大器和线性器件	www.ti.com.cn/amplifiers	计算机及周边	www.ti.com.cn/computer
数据转换器	www.ti.com.cn/dataconverters	消费电子	www.ti.com.cn/consumer-apps
DLP® 产品	www.dlp.com	能源	www.ti.com.cn/energy
DSP - 数字信号处理器	www.ti.com.cn/dsp	工业应用	www.ti.com.cn/industrial
时钟和计时器	www.ti.com.cn/clockandtimers	医疗电子	www.ti.com.cn/medical
接口	www.ti.com.cn/interface	安防应用	www.ti.com.cn/security
逻辑	www.ti.com.cn/logic	汽车电子	www.ti.com.cn/automotive
电源管理	www.ti.com.cn/power	视频和影像	www.ti.com.cn/video
微控制器 (MCU)	www.ti.com.cn/microcontrollers		
RFID 系统	www.ti.com.cn/rfidsys		
OMAP应用处理器	www.ti.com/omap		
无线连通性	www.ti.com.cn/wirelessconnectivity	德州仪器在线技术支持社区	www.deyisupport.com

邮寄地址: 上海市浦东新区世纪大道1568号, 中建大厦32楼邮政编码: 200122
Copyright © 2016, 德州仪器半导体技术(上海)有限公司

PACKAGING INFORMATION

Orderable Device	Status (1)	Package Type	Package Drawing	Pins	Package Qty	Eco Plan (2)	Lead/Ball Finish (6)	MSL Peak Temp (3)	Op Temp (°C)	Device Marking (4/5)	Samples
TPS7A3701DRVR	ACTIVE	WSON	DRV	6	3000	Green (RoHS & no Sb/Br)	CU NIPDAU	Level-2-260C-1 YEAR	-40 to 125	SJI	Samples
TPS7A3701DRVT	ACTIVE	WSON	DRV	6	250	Green (RoHS & no Sb/Br)	CU NIPDAU	Level-2-260C-1 YEAR	-40 to 125	SJI	Samples
TPS7A3721DRVR	ACTIVE	WSON	DRV	6	3000	Green (RoHS & no Sb/Br)	CU NIPDAU	Level-2-260C-1 YEAR	-40 to 125	SIX	Samples
TPS7A3721DRVT	ACTIVE	WSON	DRV	6	250	Green (RoHS & no Sb/Br)	CU NIPDAU	Level-2-260C-1 YEAR	-40 to 125	SIX	Samples
TPS7A3725DRVR	ACTIVE	WSON	DRV	6	3000	Green (RoHS & no Sb/Br)	CU NIPDAU	Level-2-260C-1 YEAR	-40 to 125	SJH	Samples
TPS7A3725DRVT	ACTIVE	WSON	DRV	6	250	Green (RoHS & no Sb/Br)	CU NIPDAU	Level-2-260C-1 YEAR	-40 to 125	SJH	Samples

(1) The marketing status values are defined as follows:

ACTIVE: Product device recommended for new designs.

LIFEBUY: TI has announced that the device will be discontinued, and a lifetime-buy period is in effect.

NRND: Not recommended for new designs. Device is in production to support existing customers, but TI does not recommend using this part in a new design.

PREVIEW: Device has been announced but is not in production. Samples may or may not be available.

OBSELETE: TI has discontinued the production of the device.

(2) Eco Plan - The planned eco-friendly classification: Pb-Free (RoHS), Pb-Free (RoHS Exempt), or Green (RoHS & no Sb/Br) - please check <http://www.ti.com/productcontent> for the latest availability information and additional product content details.

TBD: The Pb-Free/Green conversion plan has not been defined.

Pb-Free (RoHS): TI's terms "Lead-Free" or "Pb-Free" mean semiconductor products that are compatible with the current RoHS requirements for all 6 substances, including the requirement that lead not exceed 0.1% by weight in homogeneous materials. Where designed to be soldered at high temperatures, TI Pb-Free products are suitable for use in specified lead-free processes.

Pb-Free (RoHS Exempt): This component has a RoHS exemption for either 1) lead-based flip-chip solder bumps used between the die and package, or 2) lead-based die adhesive used between the die and leadframe. The component is otherwise considered Pb-Free (RoHS compatible) as defined above.

Green (RoHS & no Sb/Br): TI defines "Green" to mean Pb-Free (RoHS compatible), and free of Bromine (Br) and Antimony (Sb) based flame retardants (Br or Sb do not exceed 0.1% by weight in homogeneous material)

(3) MSL, Peak Temp. - The Moisture Sensitivity Level rating according to the JEDEC industry standard classifications, and peak solder temperature.

(4) There may be additional marking, which relates to the logo, the lot trace code information, or the environmental category on the device.

(5) Multiple Device Markings will be inside parentheses. Only one Device Marking contained in parentheses and separated by a "~" will appear on a device. If a line is indented then it is a continuation of the previous line and the two combined represent the entire Device Marking for that device.

⁽⁶⁾ Lead/Ball Finish - Orderable Devices may have multiple material finish options. Finish options are separated by a vertical ruled line. Lead/Ball Finish values may wrap to two lines if the finish value exceeds the maximum column width.

Important Information and Disclaimer: The information provided on this page represents TI's knowledge and belief as of the date that it is provided. TI bases its knowledge and belief on information provided by third parties, and makes no representation or warranty as to the accuracy of such information. Efforts are underway to better integrate information from third parties. TI has taken and continues to take reasonable steps to provide representative and accurate information but may not have conducted destructive testing or chemical analysis on incoming materials and chemicals. TI and TI suppliers consider certain information to be proprietary, and thus CAS numbers and other limited information may not be available for release.

In no event shall TI's liability arising out of such information exceed the total purchase price of the TI part(s) at issue in this document sold by TI to Customer on an annual basis.

TAPE AND REEL INFORMATION

QUADRANT ASSIGNMENTS FOR PIN 1 ORIENTATION IN TAPE

*All dimensions are nominal

Device	Package Type	Package Drawing	Pins	SPQ	Reel Diameter (mm)	Reel Width W1 (mm)	A0 (mm)	B0 (mm)	K0 (mm)	P1 (mm)	W (mm)	Pin1 Quadrant
TPS7A3701DRVR	WSON	DRV	6	3000	179.0	8.4	2.2	2.2	1.2	4.0	8.0	Q2
TPS7A3701DRVT	WSON	DRV	6	250	179.0	8.4	2.2	2.2	1.2	4.0	8.0	Q2
TPS7A3721DRVR	WSON	DRV	6	3000	179.0	8.4	2.2	2.2	1.2	4.0	8.0	Q2
TPS7A3721DRVT	WSON	DRV	6	250	179.0	8.4	2.2	2.2	1.2	4.0	8.0	Q2
TPS7A3725DRVR	WSON	DRV	6	3000	179.0	8.4	2.2	2.2	1.2	4.0	8.0	Q2
TPS7A3725DRVT	WSON	DRV	6	250	179.0	8.4	2.2	2.2	1.2	4.0	8.0	Q2

TAPE AND REEL BOX DIMENSIONS

*All dimensions are nominal

Device	Package Type	Package Drawing	Pins	SPQ	Length (mm)	Width (mm)	Height (mm)
TPS7A3701DRVR	WSON	DRV	6	3000	195.0	200.0	45.0
TPS7A3701DRVT	WSON	DRV	6	250	195.0	200.0	45.0
TPS7A3721DRVR	WSON	DRV	6	3000	195.0	200.0	45.0
TPS7A3721DRVT	WSON	DRV	6	250	195.0	200.0	45.0
TPS7A3725DRVR	WSON	DRV	6	3000	195.0	200.0	45.0
TPS7A3725DRVT	WSON	DRV	6	250	195.0	200.0	45.0

GENERIC PACKAGE VIEW

DRV 6

WSON - 0.8 mm max height

PLASTIC SMALL OUTLINE - NO LEAD



Images above are just a representation of the package family, actual package may vary.
Refer to the product data sheet for package details.

4206925/F

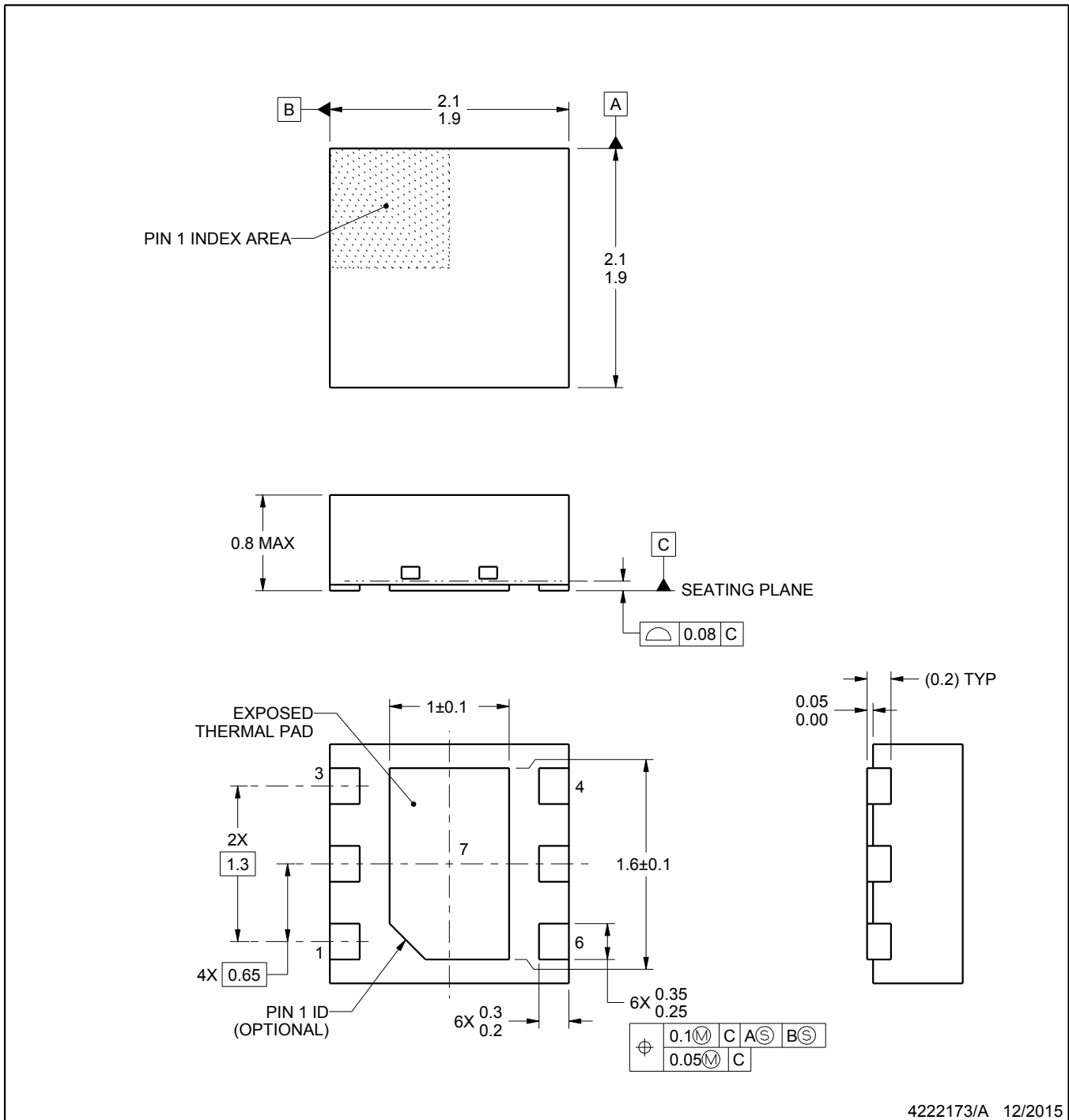
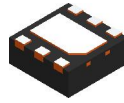

4222173/A 12/2015

NOTES:

1. All linear dimensions are in millimeters. Any dimensions in parenthesis are for reference only. Dimensioning and tolerancing per ASME Y14.5M.
2. This drawing is subject to change without notice.
3. The package thermal pad must be soldered to the printed circuit board for thermal and mechanical performance.

EXAMPLE BOARD LAYOUT

DRV0006A

WSON - 0.8 mm max height

PLASTIC SMALL OUTLINE - NO LEAD

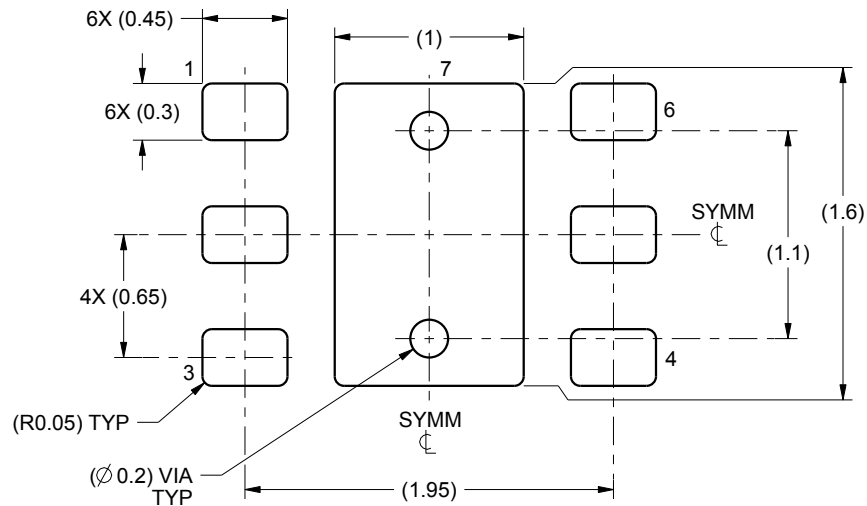

LAND PATTERN EXAMPLE
SCALE:25X

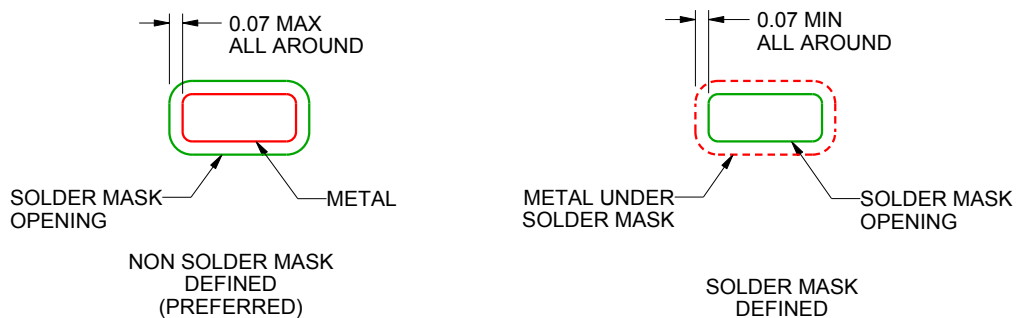

SOLDER MASK DETAILS

4222173/A 12/2015

NOTES: (continued)

4. This package is designed to be soldered to a thermal pad on the board. For more information, see Texas Instruments literature number SLUA271 (www.ti.com/lit/sluea271).
5. Vias are optional depending on application, refer to device data sheet. If some or all are implemented, recommended via locations are shown.

EXAMPLE STENCIL DESIGN

DRV0006A

WSON - 0.8 mm max height

PLASTIC SMALL OUTLINE - NO LEAD

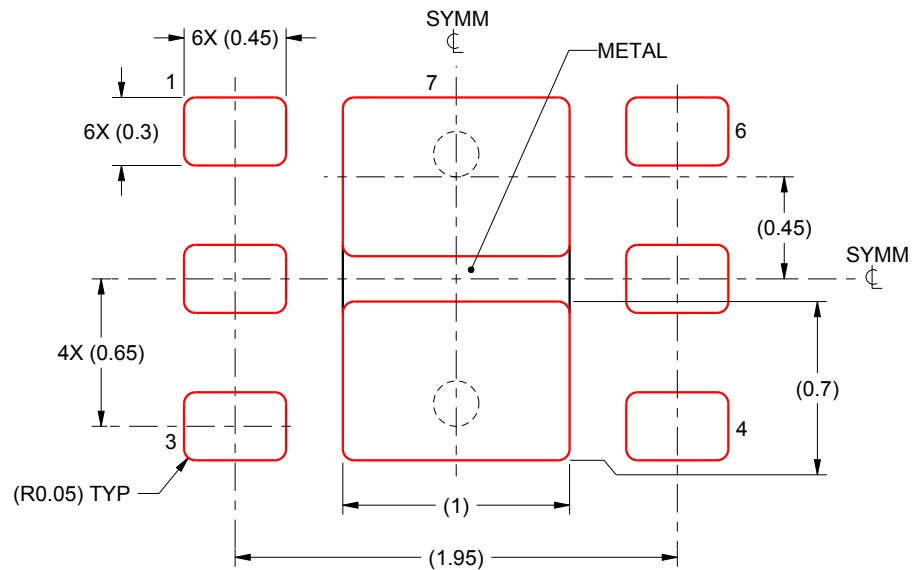

SOLDER PASTE EXAMPLE
BASED ON 0.125 mm THICK STENCIL

EXPOSED PAD #7
88% PRINTED SOLDER COVERAGE BY AREA UNDER PACKAGE
SCALE:30X

4222173/A 12/2015

NOTES: (continued)

6. Laser cutting apertures with trapezoidal walls and rounded corners may offer better paste release. IPC-7525 may have alternate design recommendations.

重要声明

德州仪器 (TI) 公司有权按照最新发布的 JESD46 对其半导体产品和服务进行纠正、增强、改进和其他修改，并不再按最新发布的 JESD48 提供任何产品和服务。买方在下订单前应获取最新的相关信息，并验证这些信息是否完整且是最新的。

TI 公布的半导体产品销售条款 (<http://www.ti.com/sc/docs/stdterms.htm>) 适用于 TI 已认证和批准上市的已封装集成电路产品的销售。另有其他条款可能适用于其他类型 TI 产品及服务的使用或销售。

复制 TI 数据表上 TI 信息的重要部分时，不得变更该等信息，且必须随附所有相关保证、条件、限制和通知，否则不得复制。TI 对该等复制文件不承担任何责任。第三方信息可能受到其它限制条件的制约。在转售 TI 产品或服务时，如果存在对产品或服务参数的虚假陈述，则会失去相关 TI 产品或服务的明示或暗示保证，且构成不公平的、欺诈性商业行为。TI 对此类虚假陈述不承担任何责任。

买方和在系统中整合 TI 产品的其他开发人员（总称“设计人员”）理解并同意，设计人员在设计应用时应自行实施独立的分析、评价和判断，且应全权负责并确保应用的安全性，及设计人员的应用（包括应用中使用的 TI 产品）应符合所有适用的法律法规及其他相关要求。设计人员就自己设计的应用声明，其具备制订和实施下列保障措施所需的一切必要专业知识，能够 (1) 预见故障的危险后果，(2) 监视故障及其后果，以及 (3) 降低可能导致危险的故障几率并采取适当措施。设计人员同意，在使用或分发包含 TI 产品的任何应用前，将彻底测试该等应用和和该等应用所用 TI 产品的功能而设计。

TI 提供技术、应用或其他设计建议、质量特点、可靠性数据或其他服务或信息，包括但不限于与评估模块有关的参考设计和材料（总称“TI 资源”），旨在帮助设计人员开发整合了 TI 产品的应用，如果设计人员（个人，或如果是代表公司，则为设计人员的公司）以任何方式下载、访问或使用任何特定的 TI 资源，即表示其同意仅为该等目标，按照本通知的条款使用任何特定 TI 资源。

TI 所提供的 TI 资源，并未扩大或以其他方式修改 TI 对 TI 产品的公开适用的质保及质保免责声明；也未导致 TI 承担任何额外的义务或责任。TI 有权对其 TI 资源进行纠正、增强、改进和其他修改。除特定 TI 资源的公开文档中明确列出的测试外，TI 未进行任何其他测试。

设计人员只有在开发包含该等 TI 资源所列 TI 产品的应用时，才被授权使用、复制和修改任何相关单项 TI 资源。但并未依据禁止反言原则或其他法律授予您任何 TI 知识产权的任何其他明示或默示的许可，也未授予您 TI 或第三方的任何技术或知识产权的许可，该等许可包括但不限于任何专利权、版权、屏蔽作品权或与应用 TI 产品或服务的任何整合、机器制作、流程相关的其他知识产权。涉及或参考了第三方产品或服务的信息不构成使用此类产品或服务的许可或与其相关的保证或认可。使用 TI 资源可能需要您向第三方获得对该等第三方专利或其他知识产权的许可。

TI 资源系“按原样”提供。TI 兹免除对资源及其使用作出所有其他明确或默示的保证或陈述，包括但不限于对准确性或完整性、产权保证、无屡发故障保证，以及适销性、适合特定用途和不侵犯任何第三方知识产权的任何默认保证。TI 不负责任何申索，包括但不限于因组合产品所致或与之有关的申索，也不为或对设计人员进行辩护或赔偿，即使该等产品组合已列于 TI 资源或其他地方。对因 TI 资源或其使用引起或与之有关的任何实际的、直接的、特殊的、附带的、间接的、惩罚性的、偶发的、从属或惩戒性损害赔偿，不管 TI 是否获悉可能会产生上述损害赔偿，TI 概不负责。

除 TI 已明确指出特定产品已达到特定行业标准（例如 ISO/TS 16949 和 ISO 26262）的要求外，TI 不对未达到任何该等行业标准要求而承担任何责任。

如果 TI 明确宣称产品有助于功能安全或符合行业功能安全标准，则该等产品旨在帮助客户设计和创作自己的符合相关功能安全标准和要求的的应用。在应用内使用产品的行为本身不会配有 任何安全特性。设计人员必须确保遵守适用于其应用的相关安全要求和标准而设计。设计人员不可将任何 TI 产品用于关乎性命的医疗设备，除非已由各方获得授权的管理人员签署专门的合同对此类应用专门作出规定。关乎性命的医疗设备是指出现故障会导致严重身体伤害或死亡的医疗设备（例如生命保障设备、心脏起搏器、心脏除颤器、人工心脏泵、神经刺激器以及植入设备）。此类设备包括但不限于，美国食品药品监督管理局认定为 III 类设备的设备，以及在美国以外的其他国家或地区认定为同等类别设备的所有医疗设备。

TI 可能明确指定某些产品具备某些特定资格（例如 Q100、军用级或增强型产品）。设计人员同意，其具备一切必要专业知识，可以为自己的应用选择适合的产品，并且正确选择产品的风险由设计人员承担。设计人员单方面负责遵守与该等选择有关的所有法律或监管要求。

设计人员同意向 TI 及其代表全额赔偿因其不遵守本通知条款和条件而引起的任何损害、费用、损失和/或责任。

邮寄地址：上海市浦东新区世纪大道 1568 号中建大厦 32 楼，邮政编码：200122
Copyright © 2018 德州仪器半导体技术（上海）有限公司