



DMOS

400mA Low-Dropout Regulator

FEATURES

- **CAP-FREE DMOS TOPOLOGY:**
Ultra Low Dropout Voltage:
250mV typ at 400mA
Output Capacitor *not* Required for Stability
- **UP TO 500mA PEAK, TYPICAL**
- **FAST TRANSIENT RESPONSE**
- **VERY LOW NOISE: 28µVrms**
- **HIGH ACCURACY: ±1.5% max**
- **HIGH EFFICIENCY:**
 $I_{GND} = 850\mu A$ at $I_{OUT} = 400mA$
Not Enabled: $I_{GND} = 0.01\mu A$
- **2.5V, 2.85V, 3.0V, 3.3V, AND 5.0V OUTPUT VERSIONS**
- **OTHER OUTPUT VOLTAGES AVAILABLE UPON REQUEST**
- **FOLDBACK CURRENT LIMIT**
- **THERMAL PROTECTION**
- **SMALL SURFACE-MOUNT PACKAGES:**
SOT23-5 and MSOP-8

APPLICATIONS

- **PORTABLE COMMUNICATION DEVICES**
- **BATTERY-POWERED EQUIPMENT**
- **PERSONAL DIGITAL ASSISTANTS**
- **MODEMS**
- **BAR-CODE SCANNERS**
- **BACKUP POWER SUPPLIES**

DESCRIPTION

The REG113 is a family of low-noise, low-dropout linear regulators with low ground pin current. Its new DMOS topology provides significant improvement over previous designs, including low-dropout voltage (only 250mV typ at full load), and better transient performance. In addition, no output capacitor is required for stability, unlike conventional low-dropout regulators that are difficult to compensate and require expensive low ESR capacitors greater than 1µF.

Typical ground pin current is only 850µA (at $I_{OUT} = 400mA$) and drops to 10nA when not enabled. Unlike regulators with PNP pass devices, quiescent current remains relatively constant over load variations and under dropout conditions.

The REG113 has very low output noise (typically 28µVrms for $V_{OUT} = 3.3V$ with $C_{NR} = 0.01\mu F$), making it ideal for use in portable communications equipment. Accuracy is maintained over temperature, line, and load variations. Key parameters are tested over the specified temperature range (–40°C to +85°C).

The REG113 is well protected—internal circuitry provides a current limit which protects the load from damage, furthermore, thermal protection circuitry keeps the chip from being damaged by excessive temperature. The REG113 is available in SOT23-5 and MSOP-8 packages.

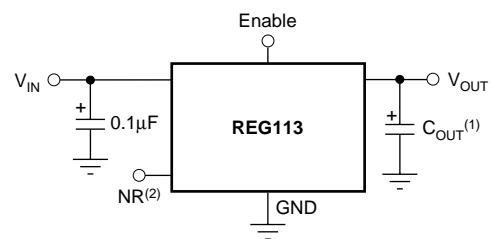

NOTES: (1) Optional. (2) NR = Noise Reduction.



Please be aware that an important notice concerning availability, standard warranty, and use in critical applications of Texas Instruments semiconductor products and disclaimers thereto appears at the end of this data sheet.

All trademarks are the property of their respective owners.

ABSOLUTE MAXIMUM RATINGS⁽¹⁾

Supply Input Voltage, V_{IN}	-0.3V to 12V
Enable Input Voltage, V_{EN}	-0.3V to V_{IN}
NR Pin Voltage, V_{NR}	-0.3V to 6.0V
Output Short-Circuit Duration	Indefinite
Operating Temperature Range (T_J)	-55°C to +125°C
Storage Temperature Range (T_A)	-65°C to +150°C
Lead Temperature (soldering, 3s)	+240°C

NOTE: (1) Stresses above these ratings may cause permanent damage. Exposure to absolute maximum conditions for extended periods may degrade device reliability.



ELECTROSTATIC DISCHARGE SENSITIVITY

This integrated circuit can be damaged by ESD. Texas Instruments recommends that all integrated circuits be handled with appropriate precautions. Failure to observe proper handling and installation procedures can cause damage.

ESD damage can range from subtle performance degradation to complete device failure. Precision integrated circuits may be more susceptible to damage because very small parametric changes could cause the device not to meet its published specifications.

PACKAGE/ORDERING INFORMATION⁽¹⁾

PRODUCT	V_{OUT} ⁽²⁾
REG113xx-yyyy/zzz	<p>XX is package designator.</p> <p>YYYY is typical output voltage (5 = 5.0V, 2.85 = 2.85V, A = Adjustable).</p> <p>ZZZ is package quantity.</p>

(1) For the most current package and ordering information, see the Package Option Addendum at the end of this document, or see the TI website at www.ti.com.

(2) Output voltages from 2.5V to 5.1V in 50mV increments are available; minimum order quantities apply. Contact factory for details and availability.

PIN CONFIGURATIONS

Top View

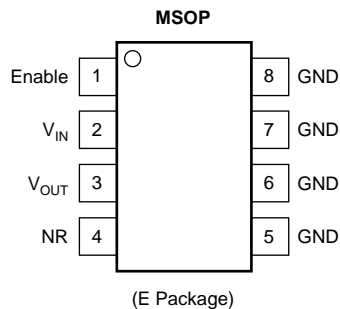
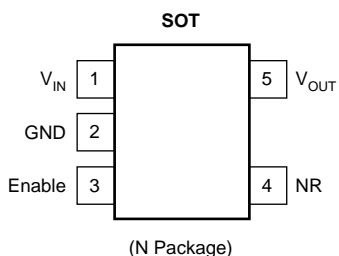

NOTE: Leads 5 through 8 are fused to the lead frame and can be used for improved thermal dissipation.

ELECTRICAL CHARACTERISTICS

Boldface limits apply over the specified temperature range, $T_J = -40^{\circ}\text{C}$ to $+85^{\circ}\text{C}$.

At $T_J = +25^{\circ}\text{C}$, $V_{IN} = V_{OUT} + 1\text{V}$, $V_{ENABLE} = 1.8\text{V}$, $I_{OUT} = 5\text{mA}$, $C_{NR} = 0.01\mu\text{F}$, and $C_{OUT} = 0.1\mu\text{F}^{(1)}$, unless otherwise noted.

PARAMETER	CONDITION	REG113NA REG113EA			UNITS
		MIN	TYP	MAX	
OUTPUT VOLTAGE					
Output Voltage Range	V_{OUT}				V
REG113-2.5			2.5		V
REG113-2.85			2.85		V
REG113-3			3.0		V
REG113-3.3			3.3		V
REG113-5			5.0		V
Accuracy			± 0.5	± 1.5	%
Over Temperature vs Temperature	dV_{OUT}/dT		50	± 2.3	%
vs Line and Load		$I_{OUT} = 5\text{mA to } 400\text{mA}$, $V_{IN} = (V_{OUT} + 0.4\text{V})$ to 10V	± 1	± 2.3	ppm/ $^{\circ}\text{C}$
Over Temperature		$I_{OUT} = 5\text{mA to } 400\text{mA}$, $V_{IN} = (V_{OUT} + 0.6\text{V})$ to 10V		± 3.0	%
DC DROPOUT VOLTAGE⁽²⁾	V_{DROD}				mV
For all models		$I_{OUT} = 5\text{mA}$	4	10	mV
Over Temperature		$I_{OUT} = 400\text{mA}$	250	325	mV
		$I_{OUT} = 400\text{mA}$		410	mV
VOLTAGE NOISE					
$f = 10\text{Hz to } 100\text{kHz}$	V_n				μVrms
Without C_{NR}		$C_{NR} = 0$, $C_{OUT} = 0$	$23\mu\text{Vrms/V} \cdot V_{OUT}$		μVrms
With C_{NR}		$C_{NR} = 0.01\mu\text{F}$, $C_{OUT} = 10\mu\text{F}$	$7\mu\text{Vrms/V} \cdot V_{OUT}$		μVrms
OUTPUT CURRENT					
Current Limit ⁽³⁾	I_{CL}	425	500	575	mA
Over Temperature				600	mA
Short-Circuit Current Limit	I_{SC}		200		mA
RIPPLE REJECTION					
$f = 120\text{Hz}$			65		dB
ENABLE CONTROL					
V_{ENABLE} HIGH (output enabled)	V_{ENABLE}	1.8		V_{IN}	V
V_{ENABLE} LOW (output disabled)		-0.2		0.5	V
I_{ENABLE} HIGH (output enabled)	I_{ENABLE}		1	100	nA
I_{ENABLE} LOW (output disabled)			2	100	nA
Output Disable Time			50		μs
Output Enable Softstart Time			1.5		ms
THERMAL SHUTDOWN					
Junction Temperature Shutdown			160		$^{\circ}\text{C}$
Reset from Shutdown			140		$^{\circ}\text{C}$
GROUND PIN CURRENT					
Ground Pin Current	I_{GND}		400	500	μA
		$I_{OUT} = 5\text{mA}$	850	1000	μA
		$I_{OUT} = 400\text{mA}$			μA
Enable Pin LOW		$V_{ENABLE} \leq 0.5\text{V}$	0.01	0.2	μA
INPUT VOLTAGE					
Operating Input Voltage Range ⁽⁵⁾	V_{IN}	1.8		10	V
Specified Input Voltage Range		$V_{IN} > 1.8\text{V}$	$V_{OUT} + 0.4$	10	V
Over Temperature		$V_{IN} > 1.8\text{V}$	$V_{OUT} + 0.6$	10	V
TEMPERATURE RANGE					
Specified Range	T_J	-40		+85	$^{\circ}\text{C}$
Operating Range	T_J	-55		+125	$^{\circ}\text{C}$
Storage Range	T_A	-65		+150	$^{\circ}\text{C}$
Thermal Resistance					
SOT23-5 Surface-Mount	θ_{JA}		200		$^{\circ}\text{C/W}$
MSOP-8 Surface-Mount	θ_{JC}		35 ⁽⁶⁾		$^{\circ}\text{C/W}$
	θ_{JA}		160 ⁽⁶⁾		$^{\circ}\text{C/W}$

NOTES: (1) The REG113 does not require a minimum output capacitor for stability. However, transient response can be improved with proper capacitor selection.

(2) Dropout voltage is defined as the input voltage minus the output voltage that produces a 2% change in the output voltage from the value at $V_{IN} = V_{OUT} + 1\text{V}$ at fixed load.

(3) Current limit is the output current that produces a 10% change in output voltage from $V_{IN} = V_{OUT} + 1\text{V}$ and $I_{OUT} = 5\text{mA}$.

(4) For $V_{ENABLE} > 6.5\text{V}$, see typical characteristic I_{ENABLE} vs V_{ENABLE} .

(5) The REG113 no longer regulates when $V_{IN} < V_{OUT} + V_{DROD(MAX)}$. In dropout, the impedance from V_{IN} to V_{OUT} is typically less than 1Ω at $T_J = +25^{\circ}\text{C}$.

(6) See Figure 7.

TYPICAL CHARACTERISTICS

For all models, at $T_J = +25^\circ\text{C}$ and $V_{\text{ENABLE}} = 1.8\text{V}$, unless otherwise noted.

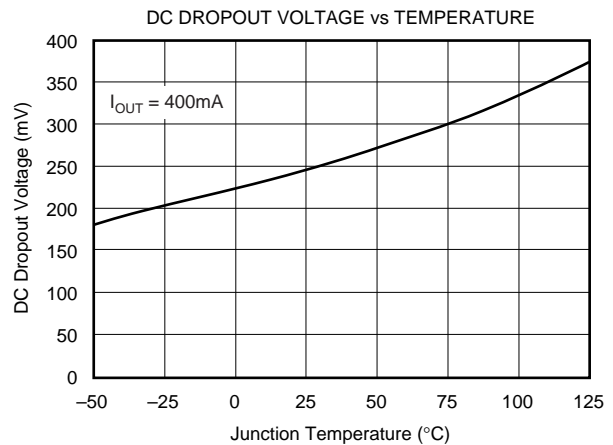
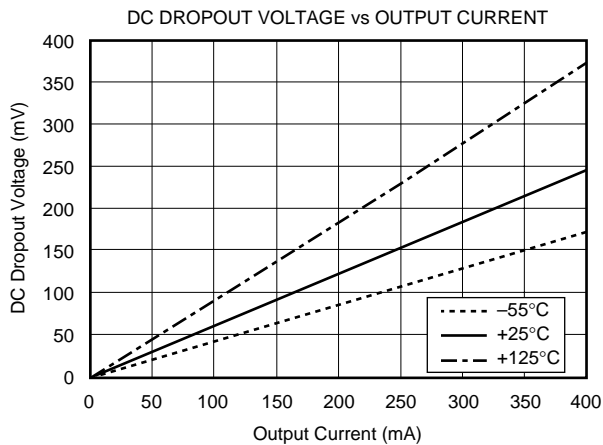
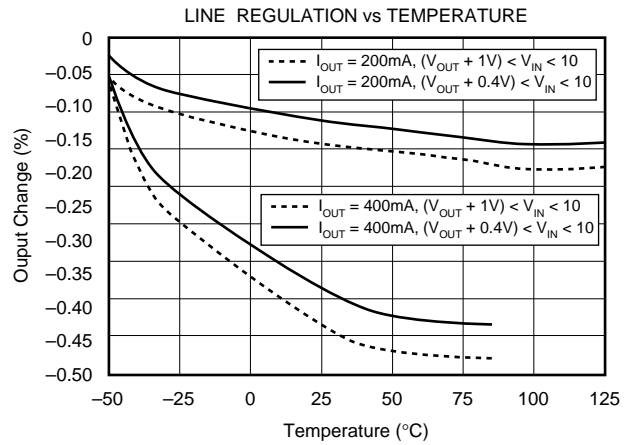
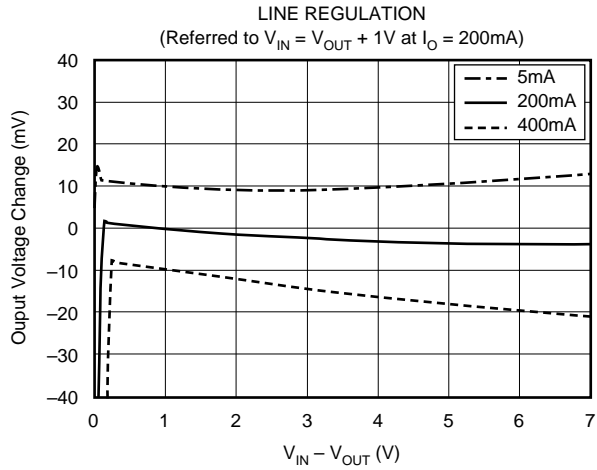
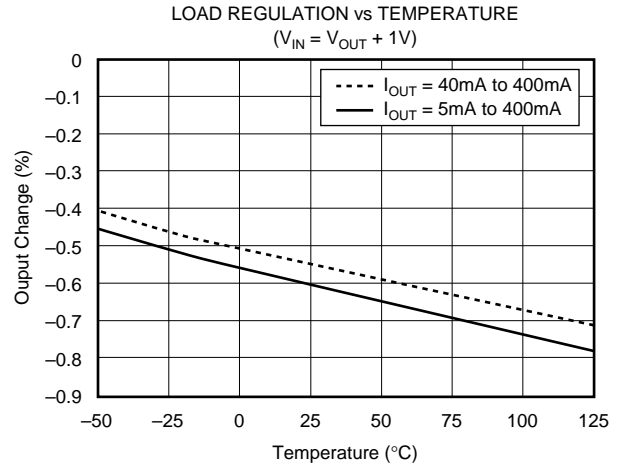
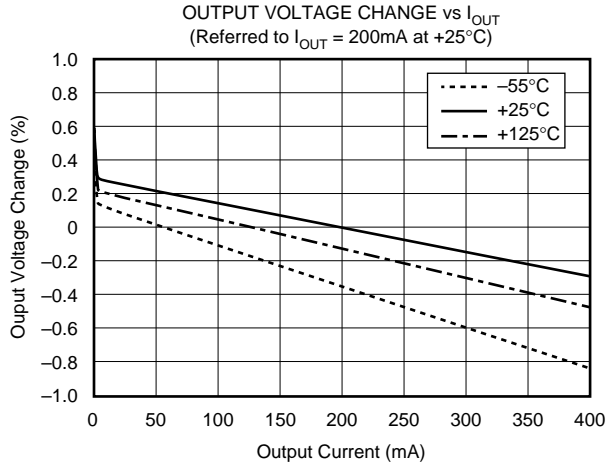

TYPICAL CHARACTERISTICS (Cont.)

For all models, at $T_J = +25^\circ\text{C}$ and $V_{\text{ENABLE}} = 1.8\text{V}$, unless otherwise noted.

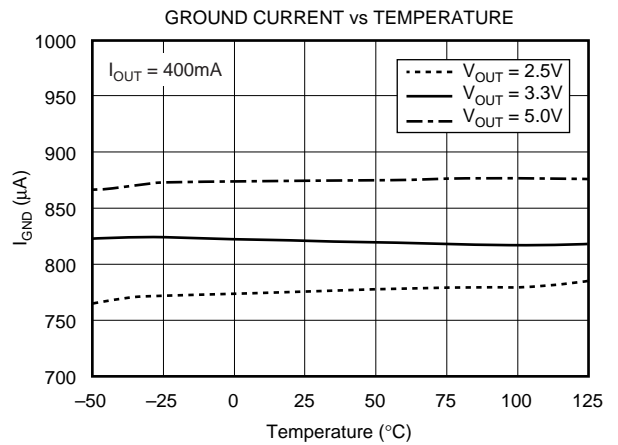
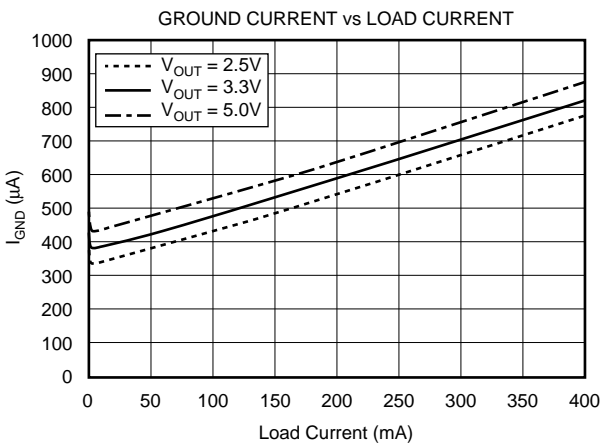
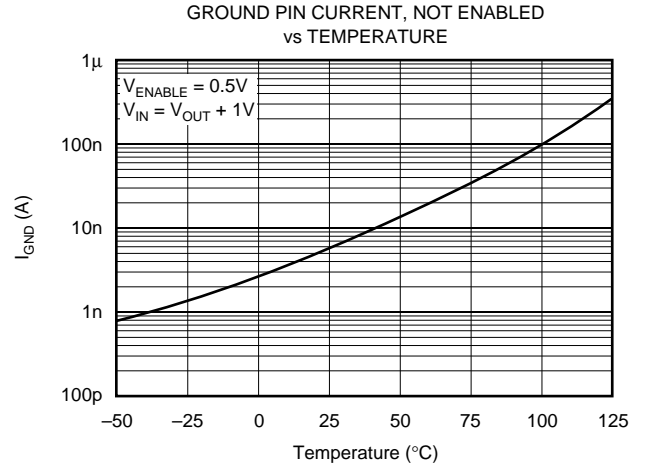
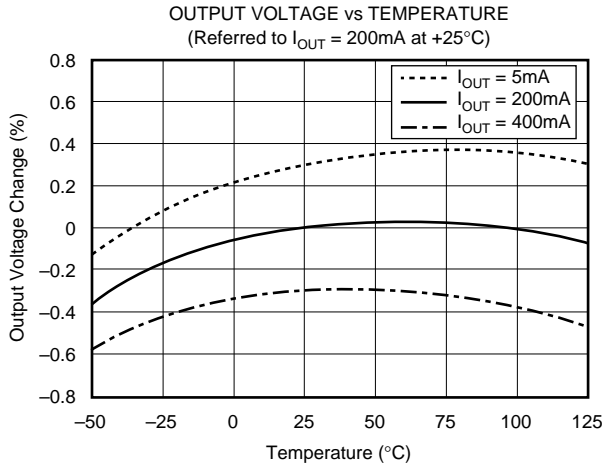
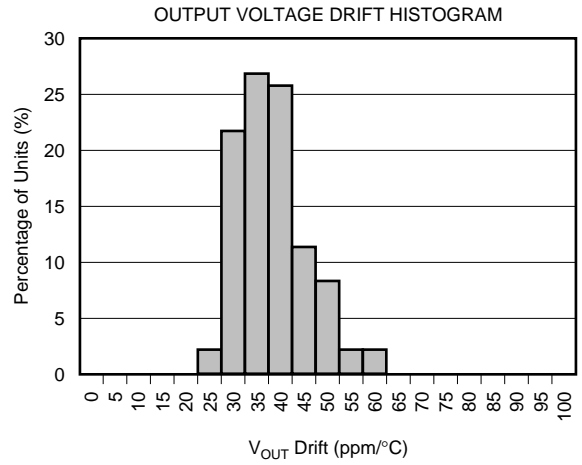
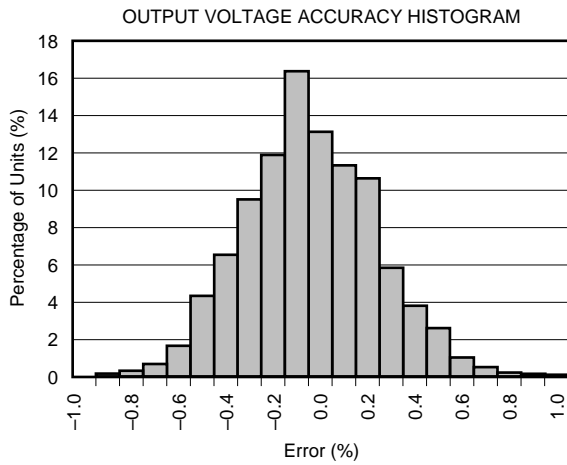

TYPICAL CHARACTERISTICS (Cont.)

For all models, at $T_J = +25^\circ\text{C}$ and $V_{\text{ENABLE}} = 1.8\text{V}$, unless otherwise noted.

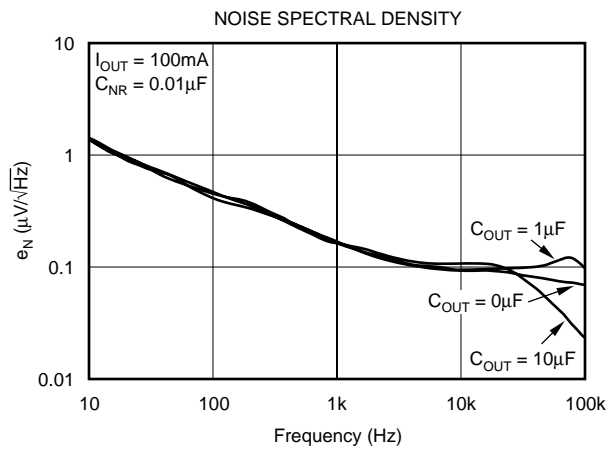
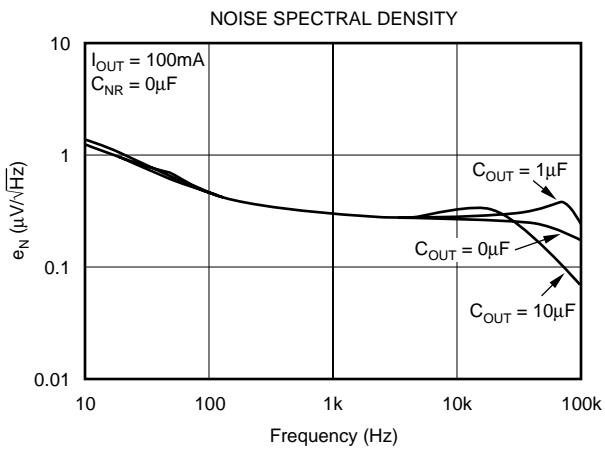
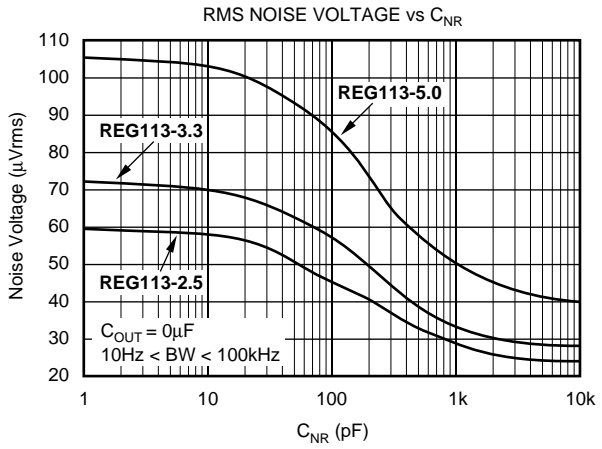
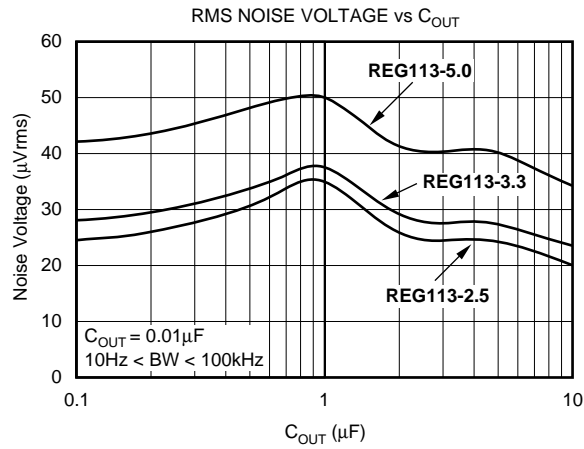
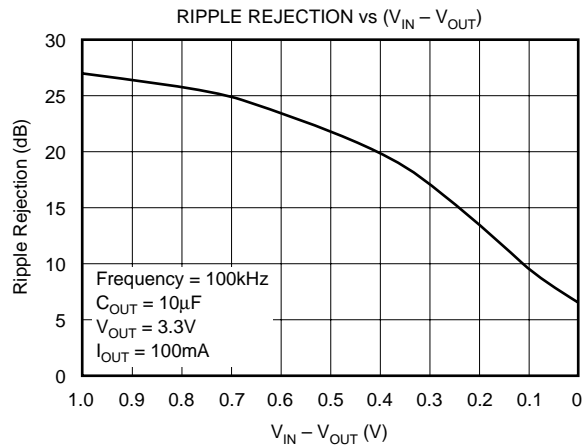
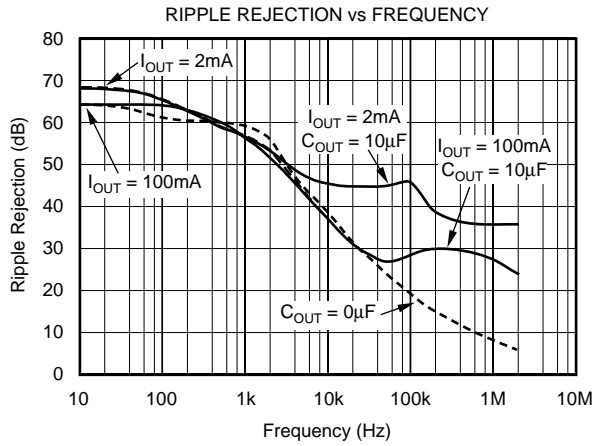

TYPICAL CHARACTERISTICS (Cont.)

For all models, at $T_J = +25^\circ\text{C}$ and $V_{\text{ENABLE}} = 1.8\text{V}$, unless otherwise noted.

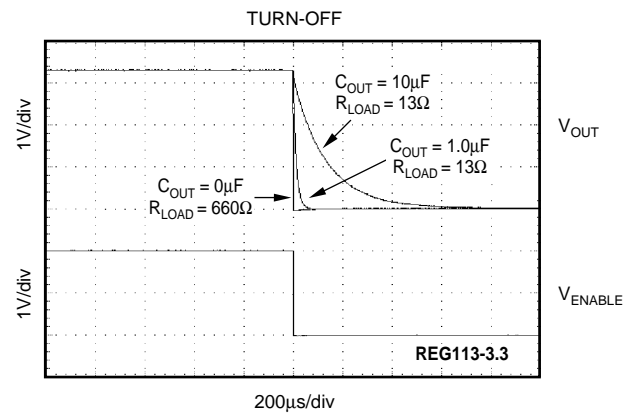
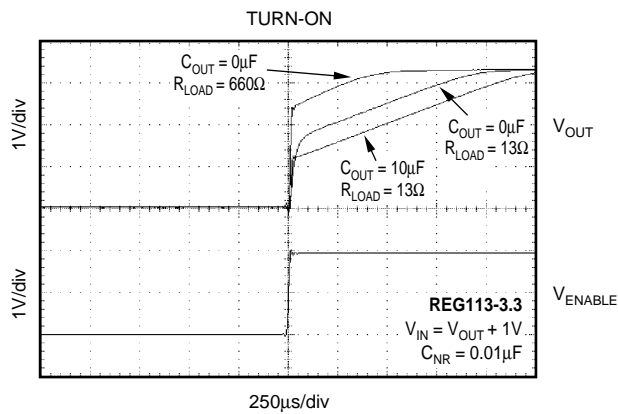
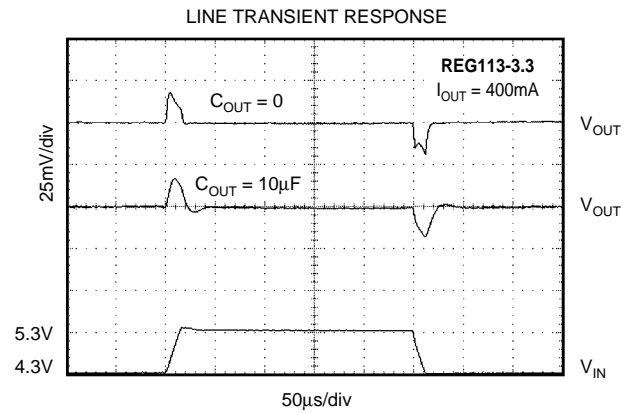
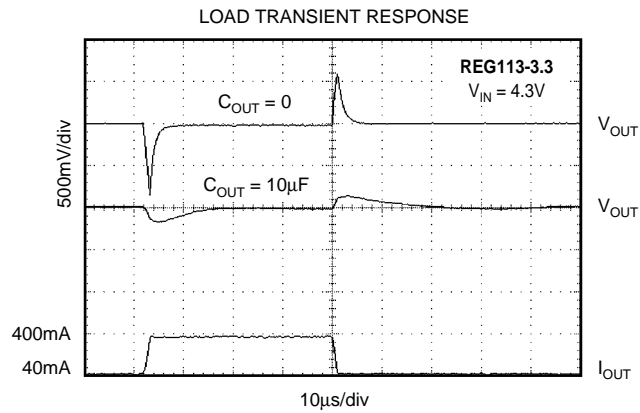
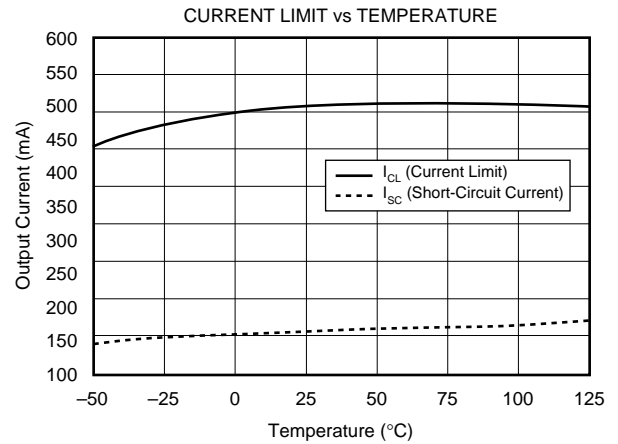
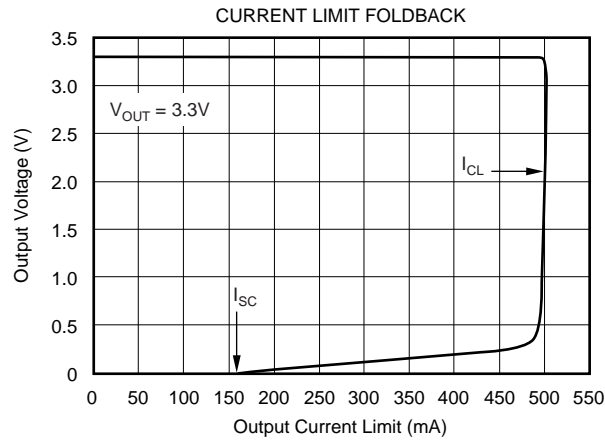

TYPICAL CHARACTERISTICS (Cont.)

For all models, at $T_J = +25^\circ\text{C}$ and $V_{\text{ENABLE}} = 1.8\text{V}$, unless otherwise noted.

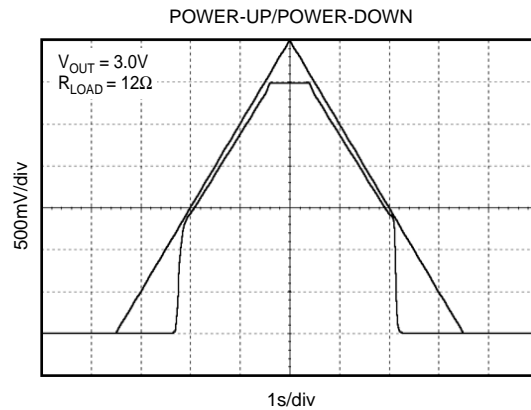
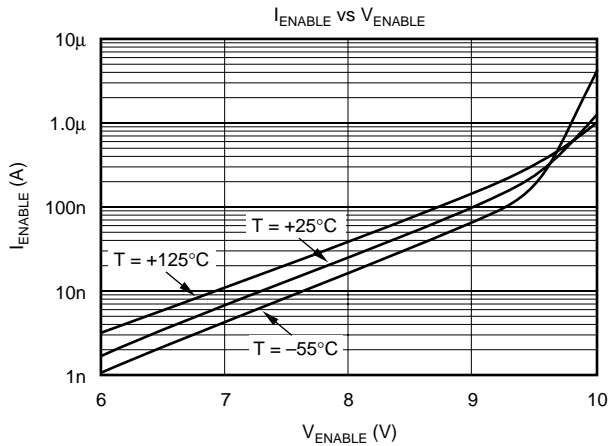

BASIC OPERATION

The REG113 series of LDO (low dropout) linear regulators offers a wide selection of fixed output voltage versions and an adjustable output version. The REG113 belongs to a family of new generation LDO regulators that use a DMOS pass transistor to achieve ultra low-dropout performance and freedom from output capacitor constraints. Ground pin current remains under 1mA over all line, load, and temperature conditions. All versions have thermal and over-current protection, including foldback current limit.

The REG113 does not require an output capacitor for regulator stability and is stable over most output currents and with almost any value and type of output capacitor up to $10\mu\text{F}$ or more. For applications where the regulator output current drops below several milliamps, stability can be enhanced by adding a $1\text{k}\Omega$ to $2\text{k}\Omega$ load resistor, using capacitance values smaller than $10\mu\text{F}$, or keeping the effective series resistance greater than 0.05Ω including the capacitor ESR and parasitic resistance in printed circuit board traces, solder joints, and sockets.

Although an input capacitor is not required, it is a good standard analog design practice to connect a $0.1\mu\text{F}$ low ESR capacitor across the input supply voltage; this is recommended to counteract reactive input sources and improve ripple rejection by reducing input voltage ripple. Figure 1 shows the basic circuit connections for the fixed voltage models.

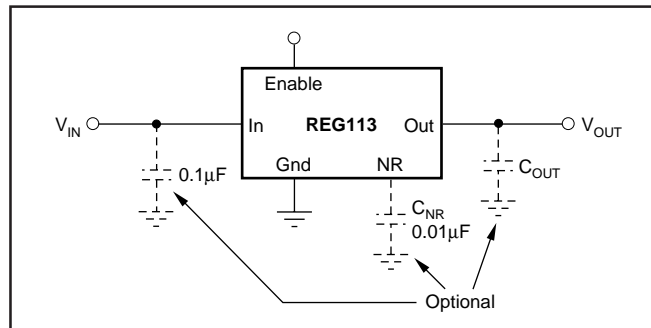

FIGURE 1. Fixed Voltage Nominal Circuit for the REG113.

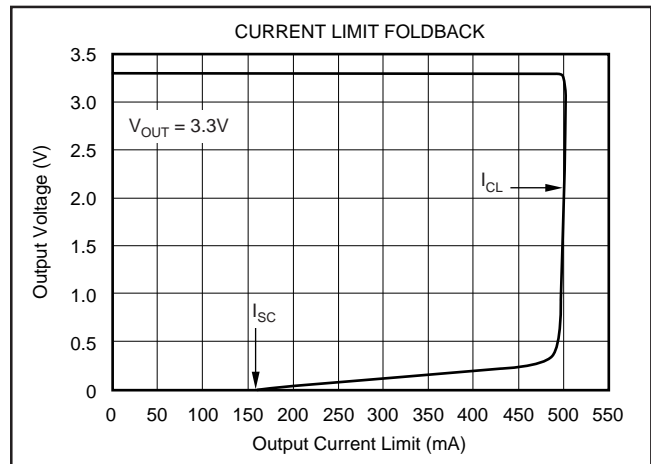

FIGURE 2. Foldback Current Limit of the REG113-3.3 at 25°C .

INTERNAL CURRENT LIMIT

The REG113 internal current limit has a typical value of 500mA. A foldback feature limits the short-circuit current to a typical short-circuit value of 200mA. A curve of V_{OUT} versus I_{OUT} is given in Figure 2, and in the Typical Characteristics section.

ENABLE

The Enable pin is active high and compatible with standard TTL-CMOS levels. Inputs below 0.5V (max) turn the regulator off and all circuitry is disabled. Under this condition, ground pin current drops to approximately 10nA . When not used, the Enable pin can be connected to V_{IN} .

OUTPUT NOISE

A precision bandgap reference is used to generate the internal reference voltage, V_{REF} . This reference is the dominant noise source within the REG113 and generates approximately $29\mu\text{V}_{\text{rms}}$ in the 10Hz to 100kHz bandwidth at the reference output. The regulator control loop gains up the reference noise, so that the noise voltage of the regulator is approximately given by:

$$V_N = 29\mu\text{V}_{\text{rms}} \frac{R_1 + R_2}{R_2} = 29\mu\text{V}_{\text{rms}} \cdot \frac{V_{\text{OUT}}}{V_{\text{REF}}} \quad (1)$$

Since the value of V_{REF} is 1.26V, this relationship reduces to:

$$V_N = 23 \frac{\mu\text{V}_{\text{rms}}}{\text{V}} \cdot V_{\text{OUT}} \quad (2)$$

Connecting a capacitor, C_{NR} , from the Noise Reduction (NR) pin to ground (as shown in Figure 3) forms a low-pass filter for the voltage reference. For $C_{NR} = 10\text{nF}$, the total noise in the 10Hz to 100kHz bandwidth is reduced by approximately a factor of 2.8 for $V_{\text{OUT}} = 3.3\text{V}$. This noise reduction effect is shown in Figure 4, and as *RMS Noise Voltage vs C_{NR}* in the Typical Characteristics section.

Noise can be further reduced by carefully choosing an output capacitor, C_{OUT} . Best overall noise performance is achieved with very low ($< 0.22\mu\text{F}$) or very high ($> 2.2\mu\text{F}$) values of C_{OUT} (see the *RMS Noise Voltage vs C_{OUT}* typical characteristic).

The REG113 uses an internal charge pump to develop an internal supply voltage sufficient to drive the gate of the DMOS pass element above V_{IN} . The charge-pump switching noise (nominal switching frequency = 2MHz) is not measurable at the output of the regulator over most values of I_{OUT} and C_{OUT} .

DROPOUT VOLTAGE

The REG113 uses an N-channel DMOS as the pass element. When $(V_{\text{IN}} - V_{\text{OUT}})$ is less than the dropout voltage (V_{DROPOUT}), the DMOS pass device behaves like a resistor; therefore, for low values of $(V_{\text{IN}} - V_{\text{OUT}})$, the regulator input-to-output resistance is the $R_{\text{ds(ON)}}$ of the DMOS pass element (typically $600\text{m}\Omega$). For static (DC) loads, the REG113 will

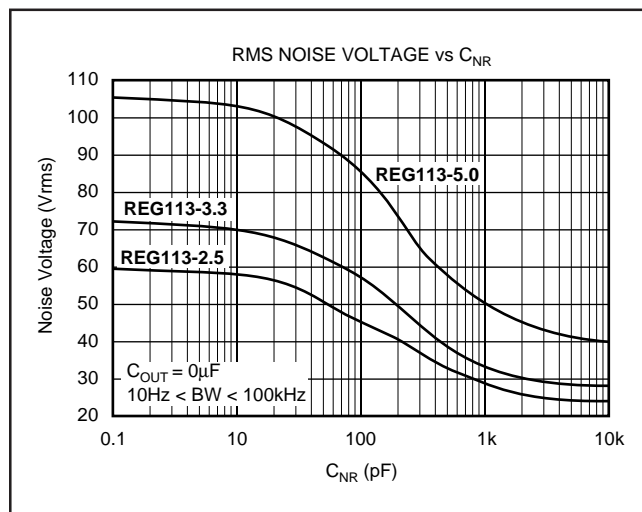

FIGURE 4. Output Noise versus Noise Reduction Capacitor.

typically maintain regulation down to a $(V_{\text{IN}} - V_{\text{OUT}})$ voltage drop of 250mV at full rated output current. In Figure 5, the bottom line (DC dropout) shows the minimum V_{IN} to V_{OUT} voltage drop required to prevent dropout under DC load conditions.

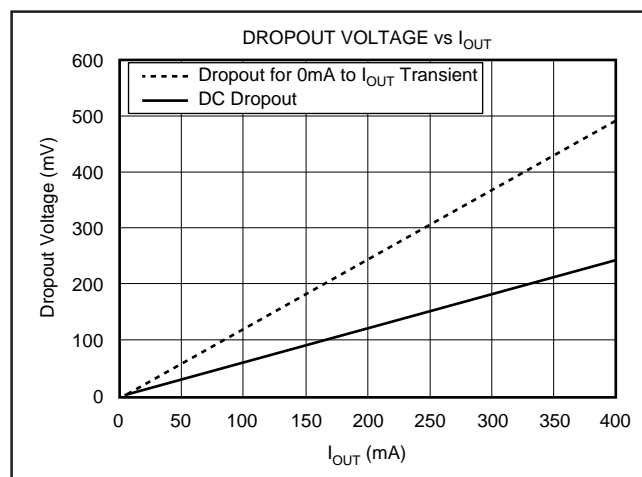

FIGURE 5. Transient and DC Dropout.

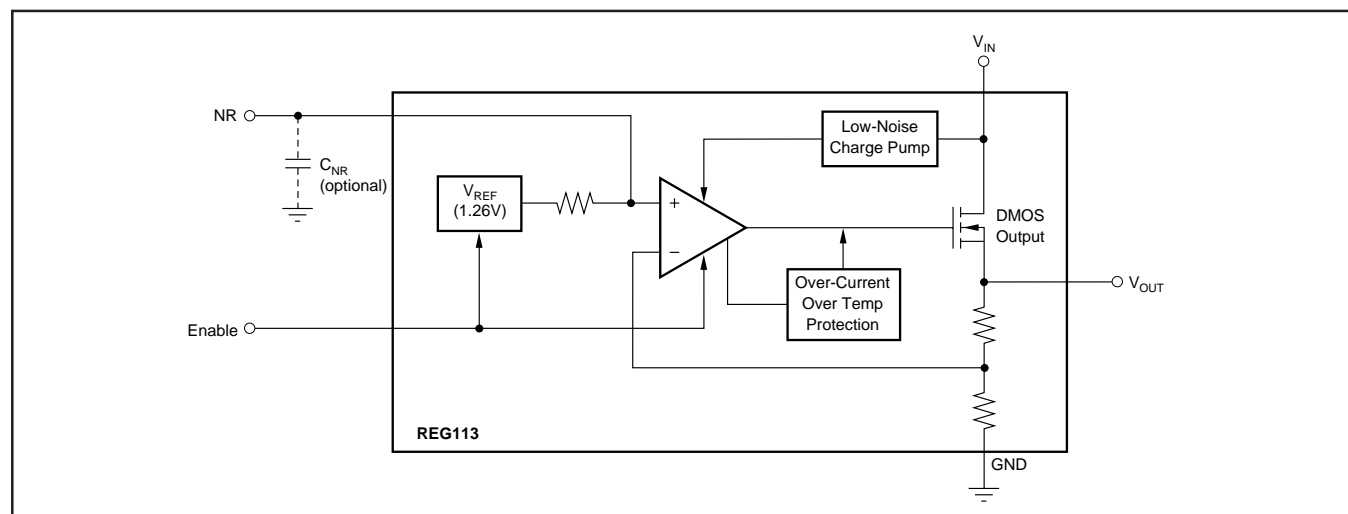

FIGURE 3. Block Diagram.

For large step changes in load current, the REG113 requires a larger voltage drop across it to avoid degraded transient response. The boundary of this transient dropout region is shown as the top line in Figure 5. Values of V_{IN} to V_{OUT} voltage drop above this line insure normal transient response.

In the transient dropout region between DC and Transient, transient response recovery time increases. The time required to recover from a load transient is a function of both the magnitude and rate of the step change in load current and the available headroom V_{IN} to V_{OUT} voltage drop. Under worst-case conditions (full-scale load change with $(V_{IN} - V_{OUT})$ voltage drop close to DC dropout levels), the REG113 can take several hundred microseconds to re-enter the specified window of regulation.

TRANSIENT RESPONSE

The REG113 response to transient line and load conditions improves at lower output voltages. The addition of a capacitor (nominal value $0.47\mu\text{F}$) from the output pin to ground may improve the transient response. In the adjustable version, the addition of a capacitor, C_{FB} (nominal value 10nF), from the output to the adjust pin also improves the transient response.

THERMAL PROTECTION

Power dissipated within the REG113 can cause the junction temperature to rise, however, the REG113 has thermal shutdown circuitry that protects the regulator from damage. The thermal protection circuitry disables the output when the junction temperature reaches approximately 160°C , allowing the device to cool. When the junction temperature cools to approximately 140°C , the output circuitry is again enabled. Depending on various conditions, the thermal protection circuit can cycle on and off. This limits the dissipation of the regulator, but can have an undesirable effect on the load.

Any tendency to activate the thermal protection circuit indicates excessive power dissipation or an inadequate heat sink. For reliable operation, junction temperature should be limited to 125°C , maximum. To estimate the margin of safety in a complete design (including heat sink), increase the ambient temperature until the thermal protection is triggered. Use worst-case loads and signal conditions. For good reliability, thermal protection should trigger more than 35°C above the maximum expected ambient condition of the application. This produces a worst-case junction temperature of 125°C at the highest expected ambient temperature and worst-case load.

The internal protection circuitry of the REG113 is designed to protect against overload conditions and is not intended to replace proper heat sinking. Continuously running the REG113 into thermal shutdown will degrade reliability.

POWER DISSIPATION

The REG113 is available in two different package configurations. The ability to remove heat from the die is different for each package type and, therefore, presents different considerations in the printed circuit board (PCB) layout. On the MSOP-8 package, leads 5 through 8 are fused to the lead frame and may be used to improve the thermal performance of the package. The PCB area around the device that is free of other components moves the heat from the device to the ambient air. Although it is difficult or impossible to quantify all of the variables in a thermal design of this type, performance data for several simplified configurations are shown in Figure 6. In all cases the PCB copper area is bare copper, free of solder resist mask, and not solder plated. All examples are for 1-ounce copper and in the case of the MSOP-8, the copper area is connected to fused leads 5 to 8. See Figure 7 for thermal resistance for varying areas of copper. Using heavier copper can increase the effectiveness in removing the heat from the device. In those examples where there is copper on both sides of the PCB, no connection has been provided between the two sides. The addition of plated through holes will improve the heat sink effectiveness.

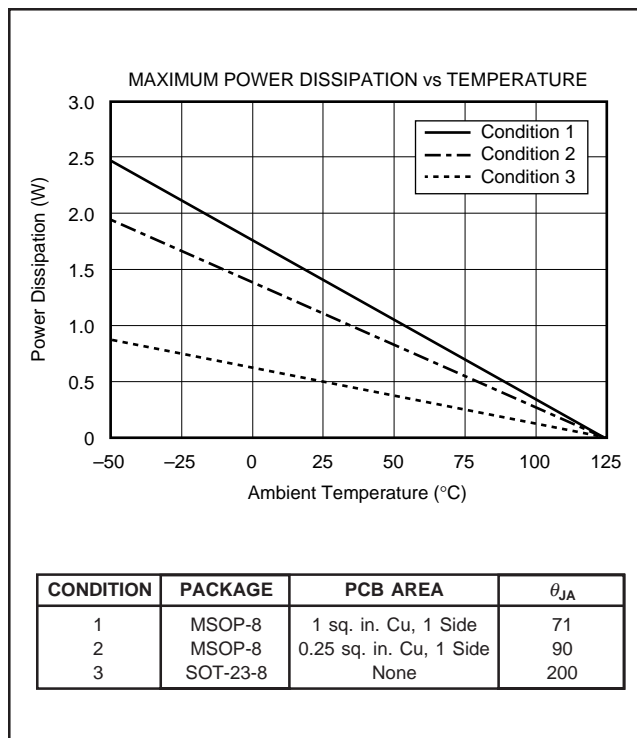

FIGURE 6. Maximum Power Dissipation versus Ambient Temperature for the Various Packages and PCB Heat Sink Configurations.

Power dissipation depends on input voltage, load conditions, and duty cycle and is equal to the product of the average output current times the voltage across the output element (V_{IN} to V_{OUT} voltage drop):

$$P_D = (V_{IN} - V_{OUT}) \cdot I_{OUT} \quad (3)$$

Power dissipation can be minimized by using the lowest possible input voltage necessary to assure the required output voltage.

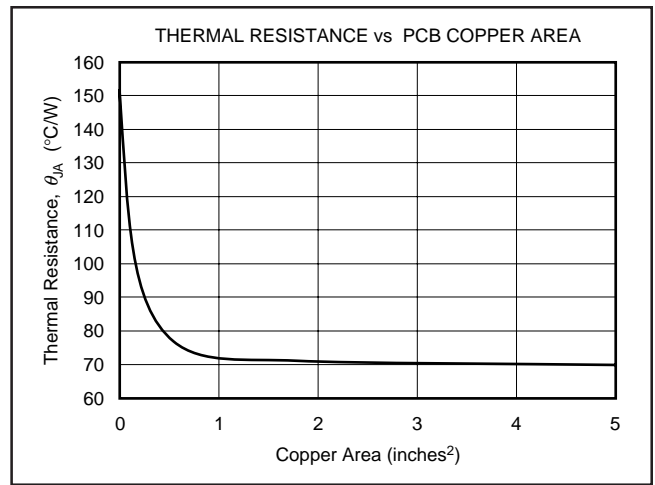

FIGURE 7. Thermal Resistance versus PCB Area for the MSOP-8.

PACKAGING INFORMATION

Orderable Device	Status (1)	Package Type	Package Drawing	Pins	Package Qty	Eco Plan (2)	Lead/Ball Finish (6)	MSL Peak Temp (3)	Op Temp (°C)	Device Marking (4/5)	Samples
REG113EA-2.5/250	ACTIVE	VSSOP	DGK	8	250	Green (RoHS & no Sb/Br)	CU NIPDAUAG	Level-2-260C-1 YEAR	-40 to 85	R13G	Samples
REG113EA-2.5/250G4	ACTIVE	VSSOP	DGK	8	250	Green (RoHS & no Sb/Br)	CU NIPDAUAG	Level-2-260C-1 YEAR	-40 to 85	R13G	Samples
REG113EA-2.5/2K5	ACTIVE	VSSOP	DGK	8	2500	Green (RoHS & no Sb/Br)	CU NIPDAUAG	Level-2-260C-1 YEAR	-40 to 85	R13G	Samples
REG113EA-2.5/2K5G4	ACTIVE	VSSOP	DGK	8	2500	Green (RoHS & no Sb/Br)	CU NIPDAUAG	Level-2-260C-1 YEAR	-40 to 85	R13G	Samples
REG113EA-3.3/250	ACTIVE	VSSOP	DGK	8	250	Green (RoHS & no Sb/Br)	CU NIPDAUAG	Level-2-260C-1 YEAR	-40 to 85	R13C	Samples
REG113EA-3.3/2K5	ACTIVE	VSSOP	DGK	8	2500	Green (RoHS & no Sb/Br)	CU NIPDAUAG	Level-2-260C-1 YEAR	-40 to 85	R13C	Samples
REG113EA-3/2K5	ACTIVE	VSSOP	DGK	8	2500	Green (RoHS & no Sb/Br)	CU NIPDAUAG	Level-2-260C-1 YEAR	-40 to 85	R13D	Samples
REG113EA-3/2K5G4	ACTIVE	VSSOP	DGK	8	2500	Green (RoHS & no Sb/Br)	CU NIPDAUAG	Level-2-260C-1 YEAR	-40 to 85	R13D	Samples
REG113EA-5/250	ACTIVE	VSSOP	DGK	8	250	Green (RoHS & no Sb/Br)	CU NIPDAUAG	Level-2-260C-1 YEAR	-40 to 85	R13B	Samples
REG113EA-5/250G4	ACTIVE	VSSOP	DGK	8	250	Green (RoHS & no Sb/Br)	CU NIPDAUAG	Level-2-260C-1 YEAR	-40 to 85	R13B	Samples
REG113EA-5/2K5	ACTIVE	VSSOP	DGK	8	2500	Green (RoHS & no Sb/Br)	CU NIPDAUAG	Level-2-260C-1 YEAR	-40 to 85	R13B	Samples
REG113EA-5/2K5G4	ACTIVE	VSSOP	DGK	8	2500	Green (RoHS & no Sb/Br)	CU NIPDAUAG	Level-2-260C-1 YEAR	-40 to 85	R13B	Samples
REG113EA33250G4	ACTIVE	VSSOP	DGK	8	250	Green (RoHS & no Sb/Br)	CU NIPDAUAG	Level-2-260C-1 YEAR	-40 to 85	R13C	Samples
REG113NA-2.5/250	ACTIVE	SOT-23	DBV	5	250	Green (RoHS & no Sb/Br)	CU NIPDAU	Level-1-260C-UNLIM	-40 to 85	R13G	Samples
REG113NA-2.5/250G4	ACTIVE	SOT-23	DBV	5	250	Green (RoHS & no Sb/Br)	CU NIPDAU	Level-1-260C-UNLIM	-40 to 85	R13G	Samples
REG113NA-2.5/3K	ACTIVE	SOT-23	DBV	5	3000	Green (RoHS & no Sb/Br)	CU NIPDAU	Level-1-260C-UNLIM	-40 to 85	R13G	Samples
REG113NA-2.85/250	ACTIVE	SOT-23	DBV	5	250	Green (RoHS & no Sb/Br)	CU NIPDAU	Level-1-260C-UNLIM	-40 to 85	R13N	Samples

Orderable Device	Status (1)	Package Type	Package Drawing	Pins	Package Qty	Eco Plan (2)	Lead/Ball Finish (6)	MSL Peak Temp (3)	Op Temp (°C)	Device Marking (4/5)	Samples
REG113NA-2.85/3K	ACTIVE	SOT-23	DBV	5	3000	Green (RoHS & no Sb/Br)	CU NIPDAU	Level-1-260C-UNLIM	-40 to 85	R13N	Samples
REG113NA-3.3/250	ACTIVE	SOT-23	DBV	5	250	Green (RoHS & no Sb/Br)	CU NIPDAU	Level-1-260C-UNLIM	-40 to 85	R13C	Samples
REG113NA-3.3/250G4	ACTIVE	SOT-23	DBV	5	250	Green (RoHS & no Sb/Br)	CU NIPDAU	Level-1-260C-UNLIM	-40 to 85	R13C	Samples
REG113NA-3.3/3K	ACTIVE	SOT-23	DBV	5	3000	Green (RoHS & no Sb/Br)	CU NIPDAU	Level-1-260C-UNLIM	-40 to 85	R13C	Samples
REG113NA-3/250	ACTIVE	SOT-23	DBV	5	250	Green (RoHS & no Sb/Br)	CU NIPDAU	Level-1-260C-UNLIM	-40 to 85	R13D	Samples
REG113NA-3/250G4	ACTIVE	SOT-23	DBV	5	250	Green (RoHS & no Sb/Br)	CU NIPDAU	Level-1-260C-UNLIM	-40 to 85	R13D	Samples
REG113NA-3/3K	ACTIVE	SOT-23	DBV	5	3000	Green (RoHS & no Sb/Br)	CU NIPDAU	Level-1-260C-UNLIM	-40 to 85	R13D	Samples
REG113NA-3/3KG4	ACTIVE	SOT-23	DBV	5	3000	Green (RoHS & no Sb/Br)	CU NIPDAU	Level-1-260C-UNLIM	-40 to 85	R13D	Samples
REG113NA-5/250	ACTIVE	SOT-23	DBV	5	250	Green (RoHS & no Sb/Br)	CU NIPDAU	Level-1-260C-UNLIM	-40 to 85	R13B	Samples
REG113NA-5/250G4	ACTIVE	SOT-23	DBV	5	250	Green (RoHS & no Sb/Br)	CU NIPDAU	Level-1-260C-UNLIM	-40 to 85	R13B	Samples
REG113NA-5/3K	ACTIVE	SOT-23	DBV	5	3000	Green (RoHS & no Sb/Br)	CU NIPDAU	Level-1-260C-UNLIM	-40 to 85	R13B	Samples

(1) The marketing status values are defined as follows:

ACTIVE: Product device recommended for new designs.

LIFEBUY: TI has announced that the device will be discontinued, and a lifetime-buy period is in effect.

NRND: Not recommended for new designs. Device is in production to support existing customers, but TI does not recommend using this part in a new design.

PREVIEW: Device has been announced but is not in production. Samples may or may not be available.

OBSOLETE: TI has discontinued the production of the device.

(2) Eco Plan - The planned eco-friendly classification: Pb-Free (RoHS), Pb-Free (RoHS Exempt), or Green (RoHS & no Sb/Br) - please check <http://www.ti.com/productcontent> for the latest availability information and additional product content details.

TBD: The Pb-Free/Green conversion plan has not been defined.

Pb-Free (RoHS): TI's terms "Lead-Free" or "Pb-Free" mean semiconductor products that are compatible with the current RoHS requirements for all 6 substances, including the requirement that lead not exceed 0.1% by weight in homogeneous materials. Where designed to be soldered at high temperatures, TI Pb-Free products are suitable for use in specified lead-free processes.

Pb-Free (RoHS Exempt): This component has a RoHS exemption for either 1) lead-based flip-chip solder bumps used between the die and package, or 2) lead-based die adhesive used between the die and leadframe. The component is otherwise considered Pb-Free (RoHS compatible) as defined above.

Green (RoHS & no Sb/Br): TI defines "Green" to mean Pb-Free (RoHS compatible), and free of Bromine (Br) and Antimony (Sb) based flame retardants (Br or Sb do not exceed 0.1% by weight in homogeneous material)

(3) MSL, Peak Temp. - The Moisture Sensitivity Level rating according to the JEDEC industry standard classifications, and peak solder temperature.

(4) There may be additional marking, which relates to the logo, the lot trace code information, or the environmental category on the device.

(5) Multiple Device Markings will be inside parentheses. Only one Device Marking contained in parentheses and separated by a "~" will appear on a device. If a line is indented then it is a continuation of the previous line and the two combined represent the entire Device Marking for that device.

(6) Lead/Ball Finish - Orderable Devices may have multiple material finish options. Finish options are separated by a vertical ruled line. Lead/Ball Finish values may wrap to two lines if the finish value exceeds the maximum column width.

Important Information and Disclaimer: The information provided on this page represents TI's knowledge and belief as of the date that it is provided. TI bases its knowledge and belief on information provided by third parties, and makes no representation or warranty as to the accuracy of such information. Efforts are underway to better integrate information from third parties. TI has taken and continues to take reasonable steps to provide representative and accurate information but may not have conducted destructive testing or chemical analysis on incoming materials and chemicals. TI and TI suppliers consider certain information to be proprietary, and thus CAS numbers and other limited information may not be available for release.

In no event shall TI's liability arising out of such information exceed the total purchase price of the TI part(s) at issue in this document sold by TI to Customer on an annual basis.

TAPE AND REEL INFORMATION

QUADRANT ASSIGNMENTS FOR PIN 1 ORIENTATION IN TAPE

*All dimensions are nominal

Device	Package Type	Package Drawing	Pins	SPQ	Reel Diameter (mm)	Reel Width W1 (mm)	A0 (mm)	B0 (mm)	K0 (mm)	P1 (mm)	W (mm)	Pin1 Quadrant
REG113EA-2.5/250	VSSOP	DGK	8	250	180.0	12.4	5.3	3.4	1.4	8.0	12.0	Q1
REG113EA-2.5/2K5	VSSOP	DGK	8	2500	330.0	12.4	5.3	3.4	1.4	8.0	12.0	Q1
REG113EA-3.3/250	VSSOP	DGK	8	250	180.0	12.4	5.3	3.4	1.4	8.0	12.0	Q1
REG113EA-3.3/2K5	VSSOP	DGK	8	2500	330.0	12.4	5.3	3.4	1.4	8.0	12.0	Q1
REG113EA-3/2K5	VSSOP	DGK	8	2500	330.0	12.4	5.3	3.4	1.4	8.0	12.0	Q1
REG113EA-5/250	VSSOP	DGK	8	250	180.0	12.4	5.3	3.4	1.4	8.0	12.0	Q1
REG113EA-5/2K5	VSSOP	DGK	8	2500	330.0	12.4	5.3	3.4	1.4	8.0	12.0	Q1
REG113NA-2.5/250	SOT-23	DBV	5	250	179.0	8.4	3.2	3.2	1.4	4.0	8.0	Q3
REG113NA-2.5/3K	SOT-23	DBV	5	3000	179.0	8.4	3.2	3.2	1.4	4.0	8.0	Q3
REG113NA-2.85/250	SOT-23	DBV	5	250	179.0	8.4	3.2	3.2	1.4	4.0	8.0	Q3
REG113NA-2.85/3K	SOT-23	DBV	5	3000	179.0	8.4	3.2	3.2	1.4	4.0	8.0	Q3
REG113NA-3.3/250	SOT-23	DBV	5	250	179.0	8.4	3.2	3.2	1.4	4.0	8.0	Q3
REG113NA-3.3/3K	SOT-23	DBV	5	3000	179.0	8.4	3.2	3.2	1.4	4.0	8.0	Q3
REG113NA-3/250	SOT-23	DBV	5	250	179.0	8.4	3.2	3.2	1.4	4.0	8.0	Q3
REG113NA-3/3K	SOT-23	DBV	5	3000	179.0	8.4	3.2	3.2	1.4	4.0	8.0	Q3
REG113NA-5/250	SOT-23	DBV	5	250	179.0	8.4	3.2	3.2	1.4	4.0	8.0	Q3
REG113NA-5/3K	SOT-23	DBV	5	3000	179.0	8.4	3.2	3.2	1.4	4.0	8.0	Q3

TAPE AND REEL BOX DIMENSIONS

*All dimensions are nominal

Device	Package Type	Package Drawing	Pins	SPQ	Length (mm)	Width (mm)	Height (mm)
REG113EA-2.5/250	VSSOP	DGK	8	250	210.0	185.0	35.0
REG113EA-2.5/2K5	VSSOP	DGK	8	2500	367.0	367.0	35.0
REG113EA-3.3/250	VSSOP	DGK	8	250	210.0	185.0	35.0
REG113EA-3.3/2K5	VSSOP	DGK	8	2500	367.0	367.0	35.0
REG113EA-3/2K5	VSSOP	DGK	8	2500	367.0	367.0	35.0
REG113EA-5/250	VSSOP	DGK	8	250	210.0	185.0	35.0
REG113EA-5/2K5	VSSOP	DGK	8	2500	367.0	367.0	35.0
REG113NA-2.5/250	SOT-23	DBV	5	250	203.0	203.0	35.0
REG113NA-2.5/3K	SOT-23	DBV	5	3000	203.0	203.0	35.0
REG113NA-2.85/250	SOT-23	DBV	5	250	203.0	203.0	35.0
REG113NA-2.85/3K	SOT-23	DBV	5	3000	203.0	203.0	35.0
REG113NA-3.3/250	SOT-23	DBV	5	250	203.0	203.0	35.0
REG113NA-3.3/3K	SOT-23	DBV	5	3000	203.0	203.0	35.0
REG113NA-3/250	SOT-23	DBV	5	250	203.0	203.0	35.0
REG113NA-3/3K	SOT-23	DBV	5	3000	203.0	203.0	35.0
REG113NA-5/250	SOT-23	DBV	5	250	203.0	203.0	35.0
REG113NA-5/3K	SOT-23	DBV	5	3000	203.0	203.0	35.0

GENERIC PACKAGE VIEW

DBV 5

SOT-23 - 1.45 mm max height

SMALL OUTLINE TRANSISTOR



Images above are just a representation of the package family, actual package may vary.
Refer to the product data sheet for package details.

4073253/P

EXAMPLE BOARD LAYOUT

DBV0005A

SOT-23 - 1.45 mm max height

SMALL OUTLINE TRANSISTOR



LAND PATTERN EXAMPLE
EXPOSED METAL SHOWN
SCALE:15X



SOLDER MASK DETAILS

4214839/C 04/2017

NOTES: (continued)

- 4. Publication IPC-7351 may have alternate designs.
- 5. Solder mask tolerances between and around signal pads can vary based on board fabrication site.

EXAMPLE STENCIL DESIGN

DBV0005A

SOT-23 - 1.45 mm max height

SMALL OUTLINE TRANSISTOR



SOLDER PASTE EXAMPLE
BASED ON 0.125 mm THICK STENCIL
SCALE:15X

4214839/C 04/2017

NOTES: (continued)

6. Laser cutting apertures with trapezoidal walls and rounded corners may offer better paste release. IPC-7525 may have alternate design recommendations.
7. Board assembly site may have different recommendations for stencil design.



- NOTES:
- A. All linear dimensions are in millimeters.
 - B. This drawing is subject to change without notice.
 - C. Publication IPC-7351 is recommended for alternate designs.
 - D. Laser cutting apertures with trapezoidal walls and also rounding corners will offer better paste release. Customers should contact their board assembly site for stencil design recommendations. Refer to IPC-7525 for other stencil recommendations.
 - E. Customers should contact their board fabrication site for solder mask tolerances between and around signal pads.

IMPORTANT NOTICE

Texas Instruments Incorporated (TI) reserves the right to make corrections, enhancements, improvements and other changes to its semiconductor products and services per JESD46, latest issue, and to discontinue any product or service per JESD48, latest issue. Buyers should obtain the latest relevant information before placing orders and should verify that such information is current and complete.

TI's published terms of sale for semiconductor products (<http://www.ti.com/sc/docs/stdterms.htm>) apply to the sale of packaged integrated circuit products that TI has qualified and released to market. Additional terms may apply to the use or sale of other types of TI products and services.

Reproduction of significant portions of TI information in TI data sheets is permissible only if reproduction is without alteration and is accompanied by all associated warranties, conditions, limitations, and notices. TI is not responsible or liable for such reproduced documentation. Information of third parties may be subject to additional restrictions. Resale of TI products or services with statements different from or beyond the parameters stated by TI for that product or service voids all express and any implied warranties for the associated TI product or service and is an unfair and deceptive business practice. TI is not responsible or liable for any such statements.

Buyers and others who are developing systems that incorporate TI products (collectively, "Designers") understand and agree that Designers remain responsible for using their independent analysis, evaluation and judgment in designing their applications and that Designers have full and exclusive responsibility to assure the safety of Designers' applications and compliance of their applications (and of all TI products used in or for Designers' applications) with all applicable regulations, laws and other applicable requirements. Designer represents that, with respect to their applications, Designer has all the necessary expertise to create and implement safeguards that (1) anticipate dangerous consequences of failures, (2) monitor failures and their consequences, and (3) lessen the likelihood of failures that might cause harm and take appropriate actions. Designer agrees that prior to using or distributing any applications that include TI products, Designer will thoroughly test such applications and the functionality of such TI products as used in such applications.

TI's provision of technical, application or other design advice, quality characterization, reliability data or other services or information, including, but not limited to, reference designs and materials relating to evaluation modules, (collectively, "TI Resources") are intended to assist designers who are developing applications that incorporate TI products; by downloading, accessing or using TI Resources in any way, Designer (individually or, if Designer is acting on behalf of a company, Designer's company) agrees to use any particular TI Resource solely for this purpose and subject to the terms of this Notice.

TI's provision of TI Resources does not expand or otherwise alter TI's applicable published warranties or warranty disclaimers for TI products, and no additional obligations or liabilities arise from TI providing such TI Resources. TI reserves the right to make corrections, enhancements, improvements and other changes to its TI Resources. TI has not conducted any testing other than that specifically described in the published documentation for a particular TI Resource.

Designer is authorized to use, copy and modify any individual TI Resource only in connection with the development of applications that include the TI product(s) identified in such TI Resource. NO OTHER LICENSE, EXPRESS OR IMPLIED, BY ESTOPPEL OR OTHERWISE TO ANY OTHER TI INTELLECTUAL PROPERTY RIGHT, AND NO LICENSE TO ANY TECHNOLOGY OR INTELLECTUAL PROPERTY RIGHT OF TI OR ANY THIRD PARTY IS GRANTED HEREIN, including but not limited to any patent right, copyright, mask work right, or other intellectual property right relating to any combination, machine, or process in which TI products or services are used. Information regarding or referencing third-party products or services does not constitute a license to use such products or services, or a warranty or endorsement thereof. Use of TI Resources may require a license from a third party under the patents or other intellectual property of the third party, or a license from TI under the patents or other intellectual property of TI.

TI RESOURCES ARE PROVIDED "AS IS" AND WITH ALL FAULTS. TI DISCLAIMS ALL OTHER WARRANTIES OR REPRESENTATIONS, EXPRESS OR IMPLIED, REGARDING RESOURCES OR USE THEREOF, INCLUDING BUT NOT LIMITED TO ACCURACY OR COMPLETENESS, TITLE, ANY EPIDEMIC FAILURE WARRANTY AND ANY IMPLIED WARRANTIES OF MERCHANTABILITY, FITNESS FOR A PARTICULAR PURPOSE, AND NON-INFRINGEMENT OF ANY THIRD PARTY INTELLECTUAL PROPERTY RIGHTS. TI SHALL NOT BE LIABLE FOR AND SHALL NOT DEFEND OR INDEMNIFY DESIGNER AGAINST ANY CLAIM, INCLUDING BUT NOT LIMITED TO ANY INFRINGEMENT CLAIM THAT RELATES TO OR IS BASED ON ANY COMBINATION OF PRODUCTS EVEN IF DESCRIBED IN TI RESOURCES OR OTHERWISE. IN NO EVENT SHALL TI BE LIABLE FOR ANY ACTUAL, DIRECT, SPECIAL, COLLATERAL, INDIRECT, PUNITIVE, INCIDENTAL, CONSEQUENTIAL OR EXEMPLARY DAMAGES IN CONNECTION WITH OR ARISING OUT OF TI RESOURCES OR USE THEREOF, AND REGARDLESS OF WHETHER TI HAS BEEN ADVISED OF THE POSSIBILITY OF SUCH DAMAGES.

Unless TI has explicitly designated an individual product as meeting the requirements of a particular industry standard (e.g., ISO/TS 16949 and ISO 26262), TI is not responsible for any failure to meet such industry standard requirements.

Where TI specifically promotes products as facilitating functional safety or as compliant with industry functional safety standards, such products are intended to help enable customers to design and create their own applications that meet applicable functional safety standards and requirements. Using products in an application does not by itself establish any safety features in the application. Designers must ensure compliance with safety-related requirements and standards applicable to their applications. Designer may not use any TI products in life-critical medical equipment unless authorized officers of the parties have executed a special contract specifically governing such use. Life-critical medical equipment is medical equipment where failure of such equipment would cause serious bodily injury or death (e.g., life support, pacemakers, defibrillators, heart pumps, neurostimulators, and implantables). Such equipment includes, without limitation, all medical devices identified by the U.S. Food and Drug Administration as Class III devices and equivalent classifications outside the U.S.

TI may expressly designate certain products as completing a particular qualification (e.g., Q100, Military Grade, or Enhanced Product). Designers agree that it has the necessary expertise to select the product with the appropriate qualification designation for their applications and that proper product selection is at Designers' own risk. Designers are solely responsible for compliance with all legal and regulatory requirements in connection with such selection.

Designer will fully indemnify TI and its representatives against any damages, costs, losses, and/or liabilities arising out of Designer's non-compliance with the terms and provisions of this Notice.