

# 东莞市承兴电子有限公司

DONG GUAN SHI CHENG XING ELECTRONICS CO.,LTD

# 承 认 书

客户名称： 立创

客户料号： C97751

零件名称： 铝电解电容器

承兴料号： KM226M450J25RR0VH2FP0

承认规格： 22uF/450V 13\*25 黑体白字

制作日期： 2018年4月10日

承办单位： 工程部

版 本： A-0

盖章处	核 准	审 核	制 作
	王祖林	石国环	肖海军

工厂地址： 广东省东莞市长安镇沙头村新沙工业区

总部地址： 广东省东莞市长安镇上沙村北横街8号凯韵大厦3楼

TEL: (0769)81604900、81604911、81604922

FAX: (0769)85648558 、85498863

客户承认栏  
Approved by

盖章处	核 准	审 核	承 办

承认盖章后请回传，感谢！

No.: CX-YX-0910-2.0



# 铝电解电容使用注意事项：

## 1、电路设计

- (1) 在确认使用及安装环境时,作为按产品样本设计说明书所规定的额定性能范围内使用电容器,应当避免在下列情况下使用:
  - a) 高温(温度超过最高使用温度);
  - b) 过流(电流超过额定纹波电流);
  - c) 过压(电压超过额定电压);
  - d) 施加反向电压或交流电压;
  - e) 使用于反复多次急剧充放电的电路中。

另: 1、在电路设计时,请选用与机器寿命相当的电容器。

2、机器性能有特殊要求时,可与研发人员探讨,制造适用的特规电容。

- (2) 电容器外壳,辅助引出端子与正负以及电路析间必须完全隔离。
- (3) 当电容器套管的绝缘不能保证时,在有绝缘性能特定要求的地方,请不使用。
- (4) 请不要在下列环境下使用电容器:
  - a) 直接与水,盐水及油类相接触,或结露的环境;
  - b) 充满有害气体的环境(硫化物,H<sub>2</sub>SO<sub>3</sub>,HNO<sub>3</sub>,CL<sub>2</sub>,氨水等);
  - c) 置于日照,O<sub>3</sub>,紫外线及有放射性物质的环境;
  - d) 振动及冲击条件超过了样本及说明书的规定范围的恶劣环境。
- (5) 在设计电容器的安装时,必须确认下列内容:
  - a) 电容器的正负极间距必须与线路板孔距吻合;
  - b) 保证电容器防爆阀上方留有一定的空间;
  - c) 电容器防爆上方尽量避免配线及安装其它元器件;
  - b) 电路板上,电容器的安装位置,请不要有其它配线;
  - e) 电容器四周及电路板上尽量避免设计,安装发热组件。
- (6) 另外,在设计电路时,必须确认以下内容:
  - a) 温度及频率的变化不至于引起电性能变化;
  - b) 双面印刷板上安装电容器时,电容器的安装位置避免多余的基板孔和过孔;
  - c) 两只以上的电容器并联连接时电流均衡;
  - d) 两只以上的电容器串联连接时电压均衡。

## 2、组件安装

- (1) 安装时,请遵守以下内容:
  - a) 为了对电容器进行点检,测定电气性能时,除了卸下的电容器,装入机器中通过电的电容器 请不要再使用;
  - b) 当电容器产生再生电压时,需通过约1KΩ左右的电阻进行放电;
  - c) 长期保存的电容器,需通过约1KΩ左右的电阻加压处理;
  - d) 确认规格(静电容量及额定电压等)及极性后,再安装;
  - e) 不要讓電容器掉到地上,掉下的電容器請不要再使用;
  - f) 变形的電容器不要再安装;
  - g) 電容器正负极间距与电路板孔必須吻合;
  - h) 自動插入機的机械手力量不宜過大。
- (2) 焊接時,請確認下面內容
  - a) 注意不要將焊錫附著在端子以外;
  - b) 焊接條件(溫度,時間,次數)必須按規定說明執行;
  - c) 不要將電容器本身浸入焊錫溶液中;
  - d) 焊接時,不要讓其它產品倒下碰到電容器上。

(3) 焊接后处理应不产生以下机械应力

- a) 电容器发生倾倒,扭转;
- b) 电容器碰到其它的线路板;
- c) 使其它的物体碰撞到电容器。

(4) 电容器不要用洗净剂洗净,但是在有必要洗净的情况下对电容器进行洗净,必须在产品规格书规定范围内进行。

(5) 对有必要洗净的电容器,洗净时,必须确认以下内容:

- a) 洗净剂污染管理(电导率,PH值,比重,水分等);
- b) 洗净后,不能保管在洗净液环境中及密闭容器中,要采用(最高使用温度以下的)热风干燥印刷电路板及电容器,使之不残留洗净液成份。

(6) 不使用含卤素的固定剂,树脂涂层剂。

(7) 使用固定剂,涂层剂,请确认以下内容:

- a) 电路板与电容器之间,不能残留焊接残渣及污垢;
- b) 固定剂,涂层剂吸附前,尽可能不残留洗净成份,进行干燥处理,使印刷孔不堵塞。

(8) 螺栓产品安装,竖直安装时,压力阀朝上,横向安装时,保证压力阀或正极端子朝上。

## 3、组装使用

(1) 组装使用中,电容器的端子间不要直接接触,另外,不要让导体物质引起正负极短路。

(2) 请确认所安装电容器处的环境:

- a) 不要与水或油污接触或处于结露状态;
- b) 不要让曝光,O<sub>3</sub>,紫外线及放射线直接照射到电容器上;
- c) 不要处于充满有害气体的环境(硫化氢,亚硫酸,亚硝酸,氯水CL<sub>2</sub>等);
- d) 震动及冲击不要超过样本或规格说明书中规定。

## 4、保守点检

工厂企业用的电容器,必须定期点检,定期点检项目包括外观检查及性能的测试。

## 5、意外情况

(1) 组装过程中,如电容防爆阀打开,请切断组装主电源或拔下电源插头。

(2) 电容器防爆阀动作时,因有超过100℃高温气体喷出,脸不要接近,喷出气体进入眼睛时,立即用水清洗眼睛。不要尝电容器的电解液,电解液 溅到皮肤上时,用肥皂清洗。

## 6、熏蒸处理

当组装电容器的电子产品出口到海外时,用溴化钾等卤化物进行熏蒸处理,因此方法可能会产生因卤素离子而引起的腐蚀反应,请务小心;熏蒸时,熏蒸液不能直接接触电子产品,同时有必要进行充分干燥处理,估计有熏蒸液附者及干燥不充分时,有必要先查询一下安全性。

## 7、储存条件

(1) 在温度为5-30℃,湿度为75%以下的室内储存。

(2) 不要保存在组装使用中禁用的环境及同等条件下。

## 8、报废情况

废弃的電容器,可任选下面一种方法进行处理:

- (1) 電容器上开孔或压碎后焚烧。
- (2) 電容器不焚烧时,交给专职废品回收人员进行处理。

Part Number System (产品编码)

1		2		3		4		5		6		7		8		9		10		11		12		13		14		15		16		17		18		19		20		21	
SERIES		CAPCITANCE		TOL.		VOLTAGE		CASE SIZE		TYPE		SLEEVE		COLOR		SHAPE		OTHERS																							
Series	Cap (MFD)	Code	Tolerance	Code	Voltage	Code	Case Size		Feature Code		Background	Code	Special	Code																											
							Liameten	Code																																	
LG	LR	0.1	104	±5%	J	004	4	3	B	Bulk	RRO	Black	H	No special	P0																										
ER	PG	0.22	224	±10%	K	6R3	6.3	4	C	PCB Termial	Green	L	Other trademark	W0																											
BR	VG	0.33	334	±15%	L	008	8	5	D	Ammo Taping	Violet	Z	Ø8 F=2.5mm	X0																											
VT	VZ	0.47	474	±20%	M	010	10	6.3	E	2.0mm Pitch	T20	Light purple																													
SM	SX	1	105	±30%	N	016	16	8	F	2.5mm Pitch	T25	Navy blue	S																												
KS	KF	2.2	225	-40%	W	025	25	10	G	3.5mm Pitch	T35	Sky blue	T																												
GM	KM	3.3	335	0		035	35	13	J	5.0mm Pitch	T50	Coffee																													
GS	EF	4.7	475	-20%	A	050	50	16	K	Lead Cut & Form		Orange red	K	Finite height	G0																										
ZF	GR	10	106	0		063	63	18	L	C-Type	CXX	Transparent blue	M	Special voltage	VX																										
LF	GF	22	226	-20%	C	100	100	25	O	V-Type	VXX	Transparent yellow	Y	Special capacitance	CX																										
EL	AL	33	336	10%		120	120	30	P	Q-Type	QXX	Printing color																													
KL	HL	47	476	-20%	X	160	160	35	Q	P-Type	PXX	Black	1																												
FL	GL	100	107	40%		200	200	40	R	W-Type	WXX	White	2																												
ML	ZL	220	227	-10%	V	220	220	51	S	K-Type	KXX	Silvery	3																												
PL	RL	330	337	20%		250	250	63.5	T	H-Type	HXX	Golden	4																												
LM	LK	470	477	0	R	315	315	76	U	Y-Type	YXX	Rubber Shape																													
LH	LL	2200	228	20%		350	350	90	X			Plane	F																												
NM	NS	22000	229	0	I	400	400	90	X			Convex	T																												
NP	NH	33000	339	50%		420	420	05	5			Snap-in	S																												
BP	PZ	47000	479			450	450	07	7	Sleeve Material	Code	V-chip	V																												
MZ	FZ	100000	10T			500	500	09	9	PET	E																														
LZ	PF	150000	15T			550	550	10	10	PVC	V																														
AP	PE	220000	22T			600	600	11	11																																
LS	LP	330000	33T					12	12																																
FP	PN	1000000	10M					13	13																																
MN	FN	2200000	22M					14	14																																
UN		3300000	33M					15	15																																
								16	16																																
								17	17																																
								20	20																																
								21	21																																
								25	25																																
								30	30																																
								35	35																																
								40	40																																
								45	45																																
								50	50																																
								55	55																																
								60	60																																

# KM Series

+105°C, General (普通品)

## FEATURES

1. Rated working voltage range 6.3 to 100V DC/160 to 450V DC at operation temperature range -40 to 105°C/-25 to +105°C.
2. This series is for communication equipments, switching power supply, industrial measuring instruments, automotive electric products, etc.

## SPECIFICATIONS

Item	Performance Characteristics								
Operation Temperature Range	-40°C~+105°C					-25~+105°C			
Rated Working Voltage Range	6.3 to 100V					160 to 450V			
Nominal Capacitance Range	0.1 to 33000μF								
Capacitance Tolerance	±20% (120HZ 20°C)								
Leakage Current	L≤0.01CV or(μA) whichever is greater					L≤0.03CV +40(μA)			
	after 2 minutes application of rated working voltage at +20°C								
tan δ (120Hz,+20°C)	Working Voltage	6.3	10	16	25	35	50	63	100
	tan δ(max.)	0.26	0.22	0.18	0.16	0.14	0.12	0.1	0.08
	Working Voltage	160	200	220	250	350	400	420	450
	tan δ(max.)	0.2	0.2	0.2	0.2	0.24	0.24	0.24	0.24
For capacitance value >1000μF, add 0.02 per another 1000μF									
Low Temperature characteristics	Impedance ratio max. at 120 HZ								
	Working Voltage(V)	6.3	10	16	25	35	50	63	100
	Z-25°C/Z+20°C	5	4	3	2	2	2	2	2
	Z-40°C/Z+20°C	10	8	6	4	3	3	3	3
	Working Voltage(V)	160	200	220	250	350	400	420	450
Z-25°C/Z+20°C	3	3	3	4	4	6	6	15	
For capacitance value >1000μF, Add 0.5 per another 1000μF for Z-25°C/Z+20°C									
Add 1.0 per another 100μF for Z-40°C/Z+20°C									
High Temperature Loading	Test conditions				Post test requirements at +20°C				
	Duration:	ΦD	≤6.3	≥8	Leakage current :≤Initial specified value				
		Load life	1000h	2000h	Cap. Change :within ±20% of initial specified value				
	Ambient temp. :+105°C				tan δ :≤200% of initial specified value				
	Applied voltage :DC voltage with maximum permissible ripple current specified at +105								
	(Sum of the DC voltage and super-imposed peak AC voltage for maximum permissible ripple current should be equal to rated DC working voltage).								
Shelf Life	Test conditions				Post test requirements at +20°C				
	Duration : 1000 hours				Same limits for high temperature loading.				
	Ambient temp : +105°C								
Applied voltage : (None)									
Other	JIS C-5101 (IEC 60384)								

## CASE SIZE TABLE

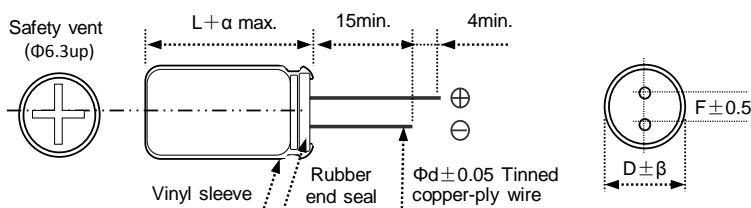

ΦD	5	6.3	8	10	13	16	18	22	25
F	2	2.5	3.5	5	5	7.5	7.5	10	10
Φd	0.5		0.6		0.8				
α	(L<20)1.5				(L≥20)2.0				
β	(D<20)0.5				(D≥20)1.0				

## RIPPLE CURRENT MULTIPLIER

### Frequency coefficient

Rated voltage(V)	Cap(μF)	50 Hz	120 Hz	300 Hz	1K Hz	10K Hz~
6.3-100	~47	0.75	1.00	1.35	1.57	2.00
	68~470	0.80	1.00	1.23	1.34	1.50
	≥560	0.85	1.00	1.10	1.13	1.15
160-450	0.47~220	0.80	1.00	1.25	1.40	1.60
	≥270	0.90	1.00	1.10	1.13	1.15



# 电 解 电 容 器 检 查 表

## TEST REPORT FOR ELEC CAPACITORS

客户料号: C97751

系列 Series	<b>KM</b>	规格 Specification	<b>22uF450V</b>	尺寸 Size	<b>13*25</b>	数量 QTY.	<b>pcs</b>
--------------	-----------	---------------------	-----------------	------------	--------------	------------	------------

1、测试仪器: LCR METER 测试仪、漏电流测试仪

2、产品尺寸图示:

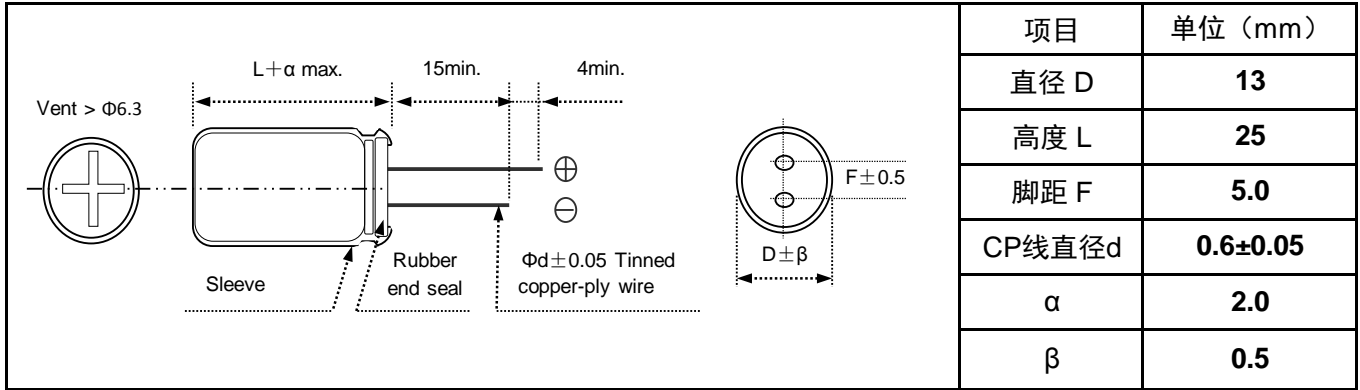

3、样品特性测试数据如下表:

[测试温度: 27 °C、湿度: 70 %]

NO.	Cap静电容量(120Hz)	D.F 损失角	L.C.漏电流	E.S.R串联等效阻抗 or Z值
	Tolerance: <u>-20~+20</u> % <u>17.6 ~ 26.4</u> (uF)	<u>120</u> Hz ≤ <u>0.24</u>	<u>450</u> V <u>2</u> 分钟 ≤ <u>337</u> (uA)	<u>100K</u> Hz ≤ (Ω)
1	20.6	0.042	30.0	
2	20.6	0.044	25.0	
3	20.7	0.043	26.0	
4	20.4	0.042	30.0	
5	20.7	0.045	24.0	
6	20.5	0.043	26.0	
7	20.5	0.044	25.0	
8	20.7	0.042	26.0	
9	20.7	0.044	20.0	
10	20.5	0.042	26.0	
Max.	20.7	0.045	30.0	
Min.	20.4	0.042	20.0	
平均值	20.6	0.043	25.8	
判定 Decision	<b>PASS</b>	<b>PASS</b>	<b>PASS</b>	

1. Scope 适用范围：

This specification applies to aluminum electrolytic capacitor, used in electronic equipment.

本说明对于用电子仪器设备进行检测之铝电解电容器适用。

2. Electrical characteristics 电气特性：

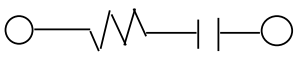
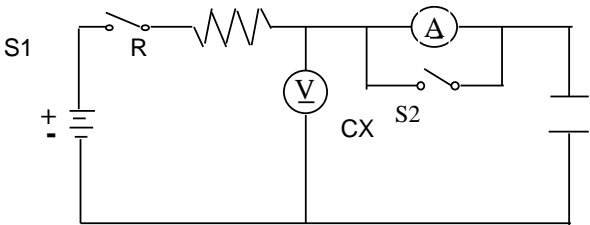
NO.	ITEM 项目	TEST METHOD 测试方法	SPECIFICATION 规格															
2.1	Rated voltage 额定电压		Voltage range、capacitance range, see specification of this series. 电压、容量范围请看该系列之规格说明。															
2.2	Capacitance 静电容量	1. Measuring frequency : 120 ± 12Hz 测定频率																
2.3	Dissipation factor 散逸因素 (损失角)	2. Measuring voltage : ≤0.5Vrms + 0.5 ~ 2.0VDC 测定电压 3. Measurement circuit :  测定电路																
2.4	Leakage current 泄漏电流	DC leakage current shall be measured after 1~2 minutes application of the DC rated working voltage through the 1000 Ω resistor at 20°C. 在20 °C通过1000Ω的电阻施加直流工作电压1~2分钟后测定直流泄漏电流。  R : 1000 ± 100Ω                      S1 : Switch 开关 A : DC current meter                      S2 : Switch for protect of 直流电流计                                  current meter V : DC voltage meter                      直流电流计的保护开关 直流电压计                                  CX : Testing capacitor 测试电容	Dissipation factor、leakage current, see specification of this series. 损失角、泄漏电流请看该系列之规格说明。															
2.5	Temperature characteristics 温度特性	<table border="1"> <thead> <tr> <th>STEP 步骤</th> <th>TEMPERATURE 温度</th> <th>STORAGE TIME 放置时间</th> </tr> </thead> <tbody> <tr> <td>1</td> <td>20°C ± 2 °C</td> <td>30 minutes</td> </tr> <tr> <td>2</td> <td>-40°C or -25°C ± 3 °C</td> <td>2 hours</td> </tr> <tr> <td>3</td> <td>20°C ± 2 °C</td> <td>15 minutes</td> </tr> <tr> <td>4</td> <td>105°C ± 2°C</td> <td>2 hours</td> </tr> </tbody> </table> <p>Step 1. Measure the capacitance and impedance. 测定静电容量及阻抗 (Z r0) . (   Z   , 20°C , 120Hz ± 10% )</p> <p>Step 2. Measure the impedance at thermal balance after 2 hours. 达到热平衡2小时后测定阻抗 (Zr) . (   Z   , -40°C or -25 °C , 120Hz ± 10% )</p> <p>Step 4. Measure the capacitance and leakage current at thermal balance after 2 hours. 达到热平衡2小时后测定静电容量及漏电流 .</p>	STEP 步骤	TEMPERATURE 温度	STORAGE TIME 放置时间	1	20°C ± 2 °C	30 minutes	2	-40°C or -25°C ± 3 °C	2 hours	3	20°C ± 2 °C	15 minutes	4	105°C ± 2°C	2 hours	<p>Step 2. Impedance ratio (Zr / Z r0) less than specified value. 阻抗比：低于规定值 .</p> <p>Step 4 Capacitance change : within ± 20% of the initial measured value. 静电容量变化：最初测定值的 ± 20%以内。 Leakage current : Less than 10 times of initial specified value . 泄漏电漏：初期规格值的10倍以下 .</p>
STEP 步骤	TEMPERATURE 温度	STORAGE TIME 放置时间																
1	20°C ± 2 °C	30 minutes																
2	-40°C or -25°C ± 3 °C	2 hours																
3	20°C ± 2 °C	15 minutes																
4	105°C ± 2°C	2 hours																



No.	ITEM 项目	TEST METHOD 测试方法	SPECIFICATION 规格
2.6	Surge test 浪涌(突波)试验	Rated surge voltage shall be applied (swich on) for 30 ± 5 seconds and then shall be applied (swich off) with discharge for 5 ± 0.5 min at room temperature . This cycle shall be repeated for 1000 cycles . Duration of one cycle is 6 ± 0.5 minutes . 在常温下施加 ( 合上开关 ) 额定涌浪电压 30 ± 5 秒, 然后停止施加 ( 断开开关 ) 涌浪电压并且放电 5 ± 0.5 分钟. 这个循环要重复 1000 次 . 以 6 ± 0.5 分钟为一个循环周期 .	① ΔC/C0在 ± 15%以内. ② DF≤2倍SPEC.或产品目录要求 ③ ILC≤初始规定值
2.7	MAXIMUM APPLICABLE RIPPLE CURRENT 高温最大纹波电流负荷试验	The maximum A.C.current having frequency of 120Hz (or 100K Hz) which can be applied to the capacitor at Max. temperature ±2℃ continuously.Peak voltage not to exceed rated D.C.voltage. 在120Hz(or 100K Hz) 频率条件下, 以电容器最高使用温度下, 施加最大的允许纹波电流.施加的AC及DC偏压不能超过DC电压.	① ΔC/C0: 见SPEC.或产品目录 ② DF≤2倍SPEC.或产品目录要求 ③ ILC≤初始规定值 注:与高温负荷判定标准一致

### 3. Mechanical characteristics 机械特性 :

No.	ITEM 项目	TEST METHOD 测试方法	SPECIFICATION 规格																										
3.1	Lead strength 端子强度	<p>(A) Tensile strength 拉伸强度 :</p> <p>wire lead terminal 导针型 :</p> <table border="1"> <tr> <td>d (mm)</td> <td>≤0.45</td> <td>0.5 ~ 0.8</td> <td>0.8 &lt; d ≤ 1.25</td> </tr> <tr> <td>load (Kg)</td> <td>0.5</td> <td>1.0</td> <td>2.0</td> </tr> </table> <p>snap-in terminal 尖脚型 :</p> <table border="1"> <tr> <td>d (mm)</td> <td>尖脚端子</td> </tr> <tr> <td>load (Kg)</td> <td>2.0</td> </tr> </table> <p>The capacitor shall withstand the constant tensile force specified between the body and each lead for 10 seconds without damage either mechanical or electrical. 电容器各端子要承受规定的荷重 10 秒, 不能有电气或机械特性上的损伤.</p> <p>(B) Bending strength 弯曲强度 :</p> <p>wire lead terminal 导针型 :</p> <table border="1"> <tr> <td>d (mm)</td> <td>≤0.45</td> <td>0.5 ~ 0.8</td> <td>0.8 &lt; d ≤ 1.25</td> </tr> <tr> <td>load (Kg)</td> <td>0.25</td> <td>0.5</td> <td>1.0</td> </tr> </table> <p>snap-in terminal 尖脚型 :</p> <table border="1"> <tr> <td>cross section area of terminal 端子截面积 (mm<sup>2</sup>)</td> <td>force 拉伸力 (Kg)</td> </tr> <tr> <td>0.5 &lt; S ≤ 1</td> <td>1.0</td> </tr> <tr> <td>S &gt; 1</td> <td>2.5</td> </tr> </table> <p>With the capacitor in a vertical position apply the load specified axially to each lead . The capacitor shall be rotated slowly from the vertical to the horizontal position , back to the vertical position . The 90° in the opposite direction and back the original position . Performance of capacitor shall not have changed and leads shall be undaged . 给在竖直位置的电容器的每一端子以轴方向施加规定荷重, 慢慢将电容器由竖直位置转至水平位置. 然后向相反方向弯曲 90°, 再回到原来位置. 电容器性能不能有变化及端子不能有损伤.</p>	d (mm)	≤0.45	0.5 ~ 0.8	0.8 < d ≤ 1.25	load (Kg)	0.5	1.0	2.0	d (mm)	尖脚端子	load (Kg)	2.0	d (mm)	≤0.45	0.5 ~ 0.8	0.8 < d ≤ 1.25	load (Kg)	0.25	0.5	1.0	cross section area of terminal 端子截面积 (mm <sup>2</sup> )	force 拉伸力 (Kg)	0.5 < S ≤ 1	1.0	S > 1	2.5	<p>When the capacitance is measured, there shall be no intermitten contacts, or open- or short- circuiting.</p> <p>测定静电容量时, 不能有接触不良, 开路或短路。</p> <p>There shall be no such mechanical damage as terminal damage etc.</p> <p>不能有如端子受损之类的机械特性上的损伤。</p>
d (mm)	≤0.45	0.5 ~ 0.8	0.8 < d ≤ 1.25																										
load (Kg)	0.5	1.0	2.0																										
d (mm)	尖脚端子																												
load (Kg)	2.0																												
d (mm)	≤0.45	0.5 ~ 0.8	0.8 < d ≤ 1.25																										
load (Kg)	0.25	0.5	1.0																										
cross section area of terminal 端子截面积 (mm <sup>2</sup> )	force 拉伸力 (Kg)																												
0.5 < S ≤ 1	1.0																												
S > 1	2.5																												

No.	ITEM 项目	TEST METHOD 测试方法	SPECIFICATION 规格
3.2	Vibration resistance 耐振性	<p>The frequency of the vibration shall vary uniformly within the range 10 to 55 Hz with the amplitude of 1.5 mm , completing the cycle in the internal of one minute .</p> <p>The capacitor shall be securely mounted by its leads with hold the body of capacitor .</p> <p>The capacitor shall be vibrated in three mutually perpendicular directions for a period of 2 hours in each direction .</p> <p>振动频率要均匀，范围为 10 Hz, 到 55 Hz，振幅为 1.5 mm，在 1 分钟内完成该循环。</p> <p>电容器将由端子牢固地固定。</p> <p>电容器会被向三个互相垂直的方向每个方向振动 2 小时。</p>	<p>Capacitance : no unsteady . 静电容量 : 稳定 .</p> <p>Appearance : no abnormal . 外观 : 无异常 .</p> <p>① Capacitance change : within <math>\pm 5\%</math> of initial measured value . 容量变化 : 最初测得值的 <math>\pm 5\%</math> 之内 .</p> <p>② <math>DF \leq</math> 同SPEC.要求</p> <p>③ <math>ILC \leq</math> 初始规定值</p>
3.3	Solderability 焊锡性	<p>The leads are dipped in the solder bath of Sn at <math>245 \pm 5^\circ\text{C}</math> for <math>3 \pm 0.5</math> seconds . The dipping depth should be set at 1.5 ~ 2.0 mm .</p> <p>端子浸没在 <math>245 \pm 5^\circ\text{C}</math> 的锡焊液中 <math>3 \pm 0.5</math> 秒 . 浸没深度设定为 1.5 ~ 2.0 mm .</p>	<p>The solder alloy shall cover the 95% or more of the dipped lead's area .</p> <p>锡液要覆盖导针浸入表面积 的 95% 以上 .</p>

#### 4. Reliability 信赖度 .

No.	ITEM 项目	TEST METHOD 测试方法	SPECIFICATION 规格
4.1	Soldering heat resistance 焊锡耐热性	<p>The leads immerse in the solder bath of Sn at <math>260 \pm 5^\circ\text{C}</math> for <math>10 \pm 1</math> seconds until a distance of 1.5 ~ 2mm from the case .</p> <p>导针在 <math>260 \pm 5^\circ\text{C}</math> 的锡焊液中浸没至离本体 1.5 ~ 2 mm 的地方 <math>10 \pm 1</math> 秒 .</p>	<p>No damage or leakage of electrolyte . 无损伤或电解液漏出 .</p> <p>Capacitance change : within <math>\pm 10\%</math> of the initial measured value . 容量变化 : 最初测定值的 <math>\pm 5\%</math> 以内 .</p> <p>Tan <math>\delta</math> : less than specified value . 损失角 : 低于规定值 .</p> <p>Leakage current : less than specified value . 泄漏电流 : 低于规定值 .</p>
4.2	Damp heat ( steady state ) 稳态湿热	<p>Subject the capacitors to <math>85 \pm 2^\circ\text{C}</math> and 85% to 95% relative humidity for 500+24/0 hours .</p> <p>电容器在 <math>85 \pm 2^\circ\text{C}</math> 及相对湿度 85% 到 95% 的条件下经历 500 (-0~+24) 小时 .</p>	<p>Capacitance change : within <math>\pm 10\%</math> of the initial measured value . 容量变化 : 最初测定值的 <math>\pm 15\%</math> 以内 .</p> <p>Tan <math>\delta</math> : less than 120% of the initial specified value . 损失角 : 低于1.2倍规定值 .</p> <p>Leakage current : less than specified value . 泄漏电流 : 低于规定值 .</p>

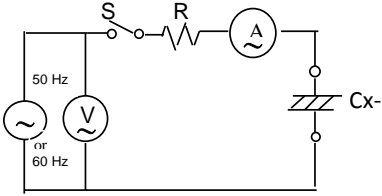
NO.	ITEM 项目	TEST METHOD 测试方法	SPECIFICATION 规格														
4.3	Load life 高温负荷	<p>After X hours continuous application of DC rated working voltage at Max. temperature <math>\pm 5^{\circ}\text{C}</math>.</p> <p>Measurements shall be performed after 2 hours exposed at room temperature .</p> <p>在最高使用温度 <math>\pm 5^{\circ}\text{C}</math> 环境当中连续施加直流定格电压 X 小时。</p> <p>( X: see specification of this series. 见该系列规格说明 . )</p>	<p>Standard of judgement is according to requirement of this series .</p> <p>判定标准依该系列要求 .</p>														
4.4	Shelf life 高温无负荷	<p>After storage for Y hours at temperature <math>\pm 5^{\circ}\text{C}</math> (See specification of this series) without voltage application , the measurements shall meet the following limits .</p> <p>Measurements shall be performed after exposed for 1 to 2 hrs at room temperature after application of DC rated voltage to the capacitor for Z minutes .</p> <p>在 目录书规定的温度环境当中不施加直流定格电压放置 Y 小时后 , 按以下条件测试 .</p> <p>测试在室温露置 1 到 2 小时 , 施加直流定格电压 Z 分锺后进行。</p> <p>( Y . Z : see specification of this series. 见该系列规格说明 . )</p>															
4.5	Storage at low temperature 低温贮存	<p>The capacitor shall be stored at the lowest(<math>\pm 3^{\circ}\text{C}</math>) temperature for 1000+24/0 hours , during which time no voltage shall be applied .</p> <p>And then the capacitor shall be subjected to standard atmospheric conditions for 16 hours or more , after which measurements shall be made .</p> <p>电容器在最低允许温度(<math>\pm 3^{\circ}\text{C}</math>) 环境当中贮存1000+24/0 小时 , 其间不施加电压 .</p> <p>之后 , 在标准大气压中露置 16 小时以上 , 然后进行测试 .</p>	<p>Capacitance change : within <math>\pm 10\%</math> of the initial value . 容量变化 : 最初值的 <math>\pm 10\%</math> 以内 .</p> <p>Tan <math>\delta</math> : less than specified value . 损失角 : 低于规定值 .</p> <p>Leakage current : less than specified value . 泄漏电流 : 低于规定值 .</p> <p>Appearance : no abnormal . 外观 : 无异常 .</p>														
4.6	Pressure relief 防爆试验	<p>AC test 交流试验 : (此条件只适用于<math>\geq 08</math>产品)</p> <p>Applied voltage : AC voltage not exceeding 0.7 times of the rated direct voltage or 250 V AC whichever is the lower .</p> <p>施加电压 : 不超过定格电压 0.7 倍的交流电压或低于交流电压 250 V 的任意电压 .</p> <p>Frequency 频率 : 50 Hz or 60 Hz .</p> <p>Series resistor : refer to the table below .</p> <p>串联阻抗 : 参照下表 .</p> <table border="1" data-bbox="456 1675 1023 1989"> <thead> <tr> <th>Capacitance ( C ) 容 量</th> <th>Series resistor 串 联 阻 抗</th> </tr> </thead> <tbody> <tr> <td><math>C \leq 1\mu\text{F}</math></td> <td>1000 <math>\Omega</math></td> </tr> <tr> <td><math>1\mu\text{F} &lt; C \leq 10\mu\text{F}</math></td> <td>100 <math>\Omega</math></td> </tr> <tr> <td><math>10\mu\text{F} &lt; C \leq 100\mu\text{F}</math></td> <td>10 <math>\Omega</math></td> </tr> <tr> <td><math>100\mu\text{F} &lt; C \leq 1000\mu\text{F}</math></td> <td>1 <math>\Omega</math></td> </tr> <tr> <td><math>1000\mu\text{F} &lt; C \leq 10000\mu\text{F}</math></td> <td>0.1 <math>\Omega</math></td> </tr> <tr> <td><math>10000\mu\text{F} &lt; C</math></td> <td>*</td> </tr> </tbody> </table> <p>* Resistance is equivalent to a half impedance by test frequency . 相当于试验频率的一半阻抗值 .</p>	Capacitance ( C ) 容 量	Series resistor 串 联 阻 抗	$C \leq 1\mu\text{F}$	1000 $\Omega$	$1\mu\text{F} < C \leq 10\mu\text{F}$	100 $\Omega$	$10\mu\text{F} < C \leq 100\mu\text{F}$	10 $\Omega$	$100\mu\text{F} < C \leq 1000\mu\text{F}$	1 $\Omega$	$1000\mu\text{F} < C \leq 10000\mu\text{F}$	0.1 $\Omega$	$10000\mu\text{F} < C$	*	<p>AC test circuit 交流试验回路</p>  <p> <math>\sim</math> : AC power 交流电源  S : Switch 开关  <math>\text{V}</math> : AC voltage meter 交流电压计  <math>\text{A}</math> : AC current meter 交流电流计  R : protection resistor 保护电阻  Cx : testing capacitor 供试电容器 </p>
Capacitance ( C ) 容 量	Series resistor 串 联 阻 抗																
$C \leq 1\mu\text{F}$	1000 $\Omega$																
$1\mu\text{F} < C \leq 10\mu\text{F}$	100 $\Omega$																
$10\mu\text{F} < C \leq 100\mu\text{F}$	10 $\Omega$																
$100\mu\text{F} < C \leq 1000\mu\text{F}$	1 $\Omega$																
$1000\mu\text{F} < C \leq 10000\mu\text{F}$	0.1 $\Omega$																
$10000\mu\text{F} < C$	*																

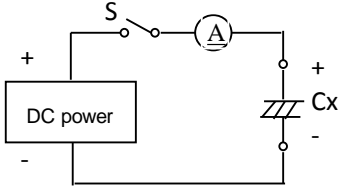
No.	ITEM 项目	TEST METHOD 测试方法	SPECIFICATION 规格
4.6	Pressure relief 防爆试验	<p>DC test :</p> <p>Send the following electricities while applying the inverse voltage .</p> <p>where case size ( D ) :</p> <p>D ≤ 22.4 mm : 1 A d.c. max D &gt; 22.4 mm : 10 A d.c. max</p> <p>Note : 1. This requirement applies to capacitors with a diameter of 8 mm or more . 2. When the pressure relief device does not open even 30 minutes after commencement of test , the test may be ended .</p>	<p>DC test circuit</p>  <p>S : Switch Ⓐ : DC current meter Cx : testing capacitor</p> <p>The pressure relief device shall open in such a way as to avoid any danger of fire or explosion of capacitor elements ( terminal and metal foil etc ) or cover .</p>

### 5. 外观Marking :

产品外套管印刷内容如下

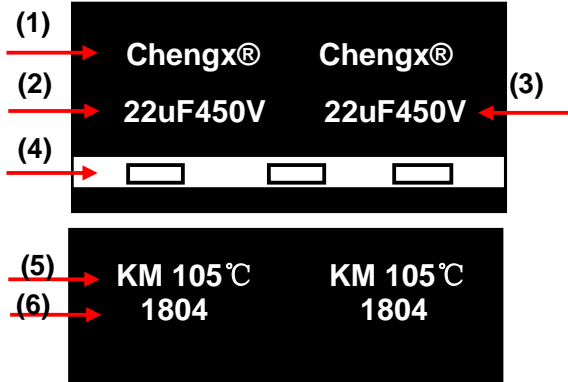
序号	项目内容说明	图示
(1)	商标	
(2)	标称静电容量	
(3)	额定工作电压	
(4)	负极线标示	
(5)	系列、温度	
(6)	周期、材质	

6.包装数量标准:

产品外形尺寸 D×L (mm)	小袋数量 (只/袋)	散装/切脚 (袋/内箱)	散装/切脚内箱 (KPCS)	散装/切脚大箱 (KPCS) ( KPCS )	备注
φ3*5	2000+3	25	50	100	
φ4*5-7、φ5*5	1000+2	50	50	100	
φ6.3*5、φ5*7	1000+2	30	30	60	
φ6.3*7、φ5*11/12	1000+2	25	25	50	
φ6.3*11、φ8*5	1000+1	20	20	40	
φ6.3*12	1000+1	16	16	32	
φ8*7	1000+1	18	18	36	
φ8*9	500+1	30	15	30	
φ8*11/12	500+1	25/25	12.5/12.5	25/25	
φ8*14	500+1	20	10	20	
φ8*16-20	500+1	16	8	16	
φ10*13	500+1	15	7.5	15	
φ10*15	400	15	6	12	
φ10*17-20	200	25	5	10	
φ10*25	200	20	4	8	
φ10*30	100	30	3	6	
φ13*17-21	200	15	3	6	
φ13*25	200	12	2.4	4.8	
φ13*30	100	20	2	4	
φ16*18-22	100	20	2	4	
φ16*25	100	15	1.5	3	
φ16*30	100	12	1.2	2.4	
φ16*35	50	20	1	2	
φ18*27	100	10	1	2	
φ18*30	50	15	0.75	1.5	
φ18*36	50	15	0.75	1.5	
φ18*40	50	10	0.5	1.5	
φ18*50	25	15	0.375	0.75	
φ22*30	50	10	0.5	1	
φ22*35	50	10	0.5	1	
φ22*40	50	10	0.5	1	
φ25*25	50	10	0.5	1	
φ25*30	50	10	0.5	1	

备注: 包装外箱L480mm\*W320mm\*H320mm

内箱L300mm\*W230mm\*H300mm

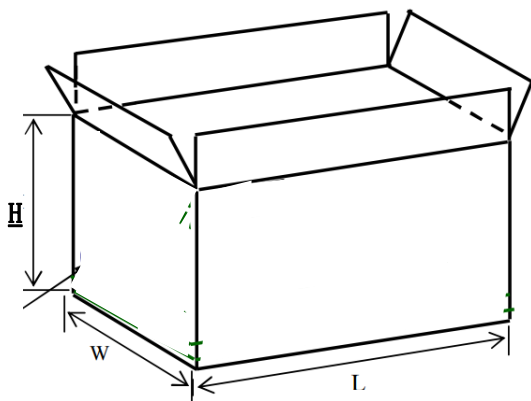

外箱

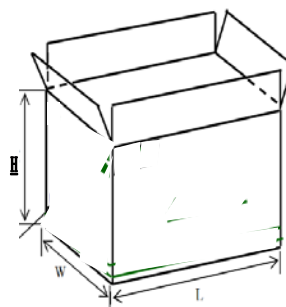

内箱