



ORIENT

深圳市奥伦德元器件有限公司

样 品 规 格 书

品名: _____
客户型号: _____
本厂型号: _____
日期: _____

深圳市奥伦德元器件有限公司
Shenzhen Orient Components Co.,Ltd.
深圳市光明新区光明同富裕工业区 3 栋 1 楼
1/F,Block 3,Guang Ming Tong Fuyu Industrial
Park,Guang Ming New District,Shenzhen
Tel: 86-755-27478389
Fax: 86-755-29980030
www.orient-intl.com

审核	制表



● 特点:

1. 电流转换比(CTR: 最小. 50%工作条件 $I_F=5\text{mA}$, $V_{CE}=5\text{V}$)
2. 绝缘电压: ($V_{ISO}=5,000\text{Vrms}$)
3. 响应时间 (t_r : TYP. $4\mu\text{s}$ 工作条件 $V_{CE}=2\text{V}$, $I_C=2\text{mA}$, $R_L=100\ \Omega$)
4. CE 认证 (AC/0431008)

● 说明

1. ORPC-817M 系列光耦合器的组成是: 由一个 GaAs 的发射管和一个 NPN 的晶体管组成
2. ORPC-817M 的 BIN 脚宽是 2.54mm

● 应用范围:

1. 电脑.
2. 器具的应用, 测量机.
3. 贮存器, 复印机, 自动售货机.
4. 家用电器, 如风扇等.
5. 信号传输系统.

● 最大绝对额定值 (常温=25°C)

参数		符号	额定值	单位
输入	顺向电流	I_F	50	mA
	逆向电压	V_R	6	V
	功率消耗	P	70	mW
输出	集极与射极电压	V_{CEO}	35	V
	射极与集极电压	V_{ECO}	6	
	集极电流	I_C	50	mA
	功率消耗	P_C	150	mW
总功率消耗		P_{tot}	200	mW
*1 绝缘电压		V_{iso}	5,000	Vrms
最大绝缘电压		V_{IOTM}	6,000	V
额定脉冲绝缘电压		V_{IORM}	630	V
工作温度		T_{opr}	-30 to + 100	°C
存贮温度		T_{stg}	-55 to + 125	
*2 焊锡温度		T_{sol}	260	

*1. 交流测试, 时间 1 分钟, 湿度. =40~60%

如下是绝缘测试的方法.

- (1) 将产品的两端短路。
- (2) 测试绝缘电压时无电流通过。
- (3) 测试时加正弦波形电压。



*2. 锡焊时间为 10 秒

● 光电特性(常温=25°C)

参数		符号	条件	最小.	中.	最大	单位
输入	顺向电压	VF	IF=20mA	---	1.2	1.4	V
	逆向电流	IR	VR=4V	---	---	10	μ A
	集极电容	Ct	V=0, f=1KHz	---	30	250	pF
输出	集极至射极电流	ICEO	VCE=20V, IF=0	---	---	100	nA
	集极与射极衰减电压	BVCEO	IC=0.1mA IF=0	35	---	---	V
	射极与集极衰减电压	BVECO	IE=10 μ A IF=0	6	---	---	V
传输特性	集极电流	Ic	IF=5mA	2.5	---	30	mA
	*1 电流转换比	CTR	VCE=5V	50	---	600	%
	集极与射极饱和电压	VCE(sat)	IF=20mA IC= 1mA	---	0.1	0.2	V
	绝缘阻抗	Riso	DC500V 40~60%R.H.	5 \times 10 ¹⁰	1 \times 10 ¹¹	---	Ω
	电容量	Cf	V=0, f=1MHz	---	0.6	1	pF
	转换频率	fc	VCE=5V, IC=2mA RL=100 Ω , -3dB	---	80	---	kHz
	上升时间	tr	VCE=2V, IC=2mA	---	4	18	μ s
	下降时间	tf	RL=100 Ω	---	3	18	μ s

*1 电流转换比= IC / IF \times 100%

● 电流转换比的等级分类

等级标示	最小. (%)	最大. (%)
L	50	100
A	80	160
B	130	260
C	200	400
D	300	600
L or A or B or C or D	50	600

说明：



1. 工作条件: $I_F=5\text{mA}$, $V_{CE}=5\text{V}$, $T_a=25^\circ\text{C}$.

● 外形尺寸

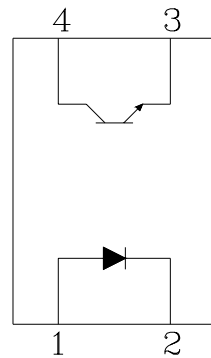
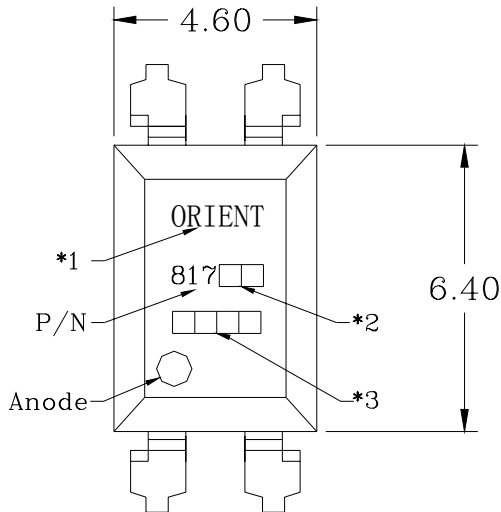

Pin No. and Internal connection diagram

- 1. Anode
- 2. Cathode
- 3. Emitter
- 4. Collector

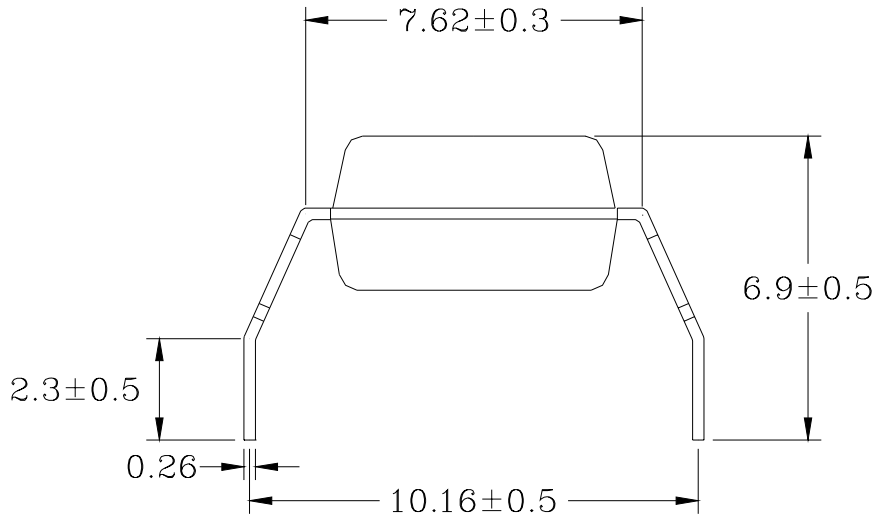
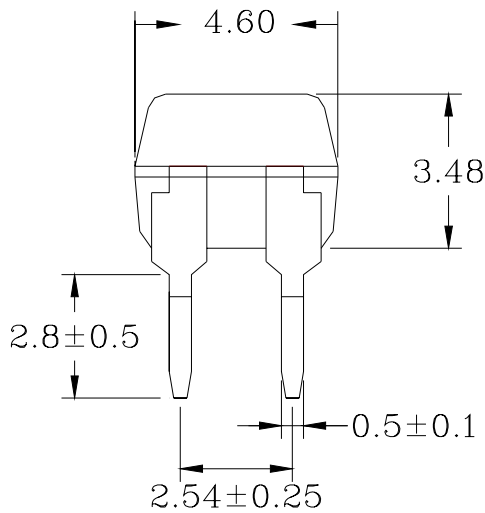

● 注解:

- *1. 公司英文名.
- *2. BIN 级.
- *3. 生产周期.



● 特性曲线

Fig.1 Forward Current vs. Ambient Temperature

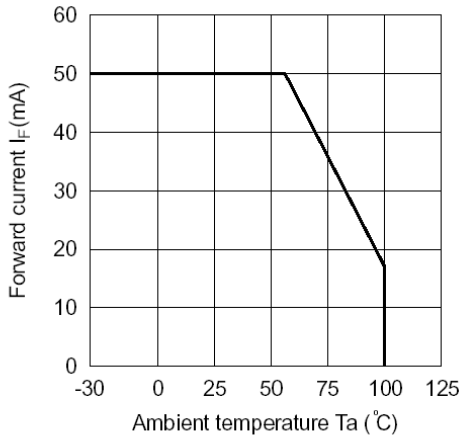

Fig.2 Collector Power Dissipation vs. Ambient Temperature

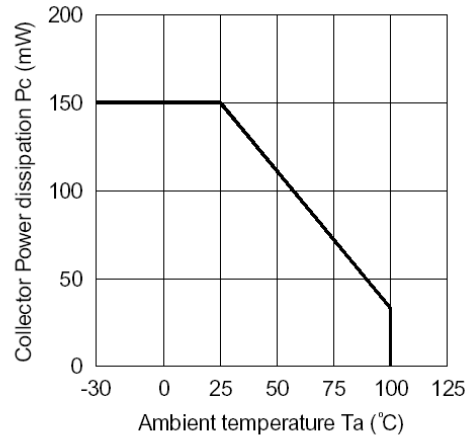

Fig.3 Collector-emitter Saturation Voltage vs. Forward Current

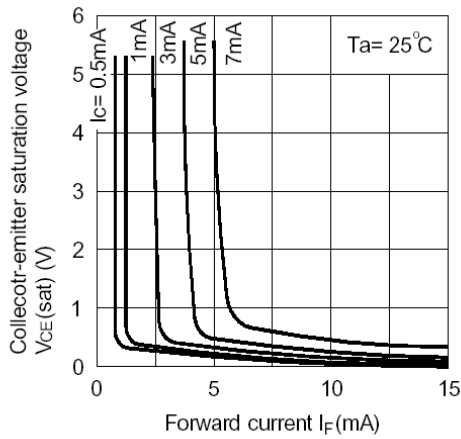

Fig.4 Forward Current vs. Forward Voltage

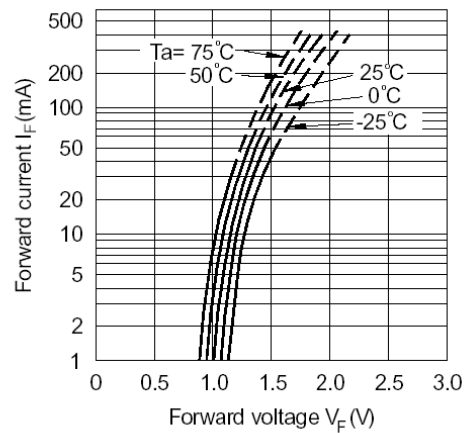

Fig.5 Current Transfer Ratio vs. Forward Current

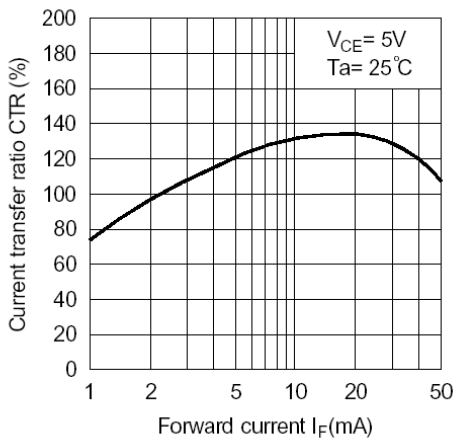
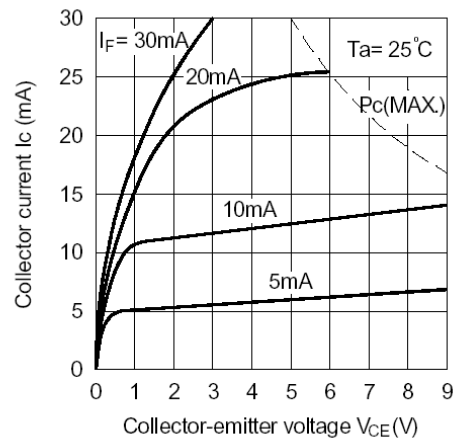

Fig.6 Collector Current vs. Collector-emitter Voltage





● 特性曲线

Fig.7 Relative Current Transfer Ratio vs. Ambient Temperature

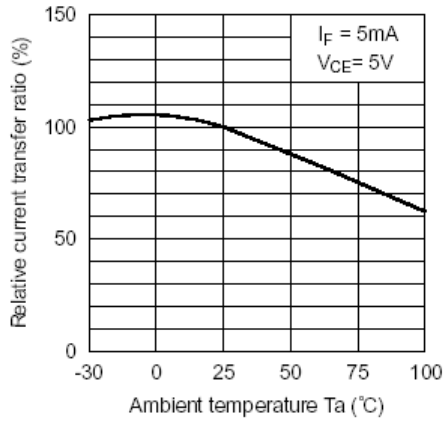

Fig.8 Collector-emitter Saturation Voltage vs. Ambient Temperature

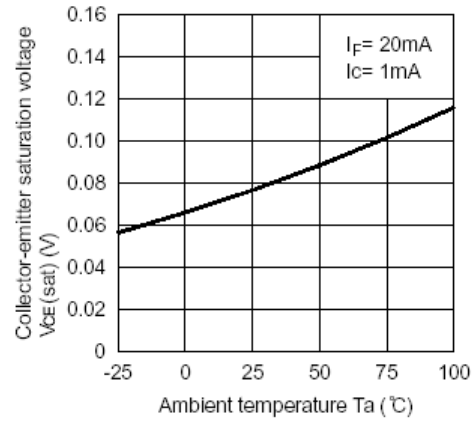

Fig.9 Collector Dark Current vs. Ambient Temperature

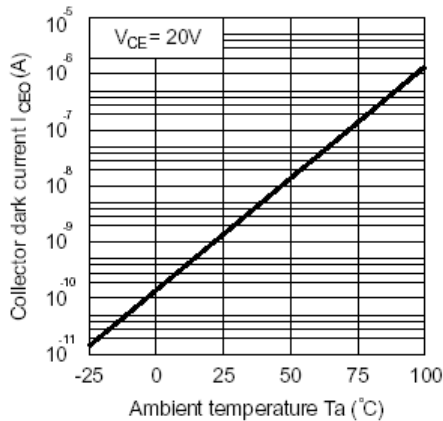

Fig.10 Response Time vs. Load Resistance

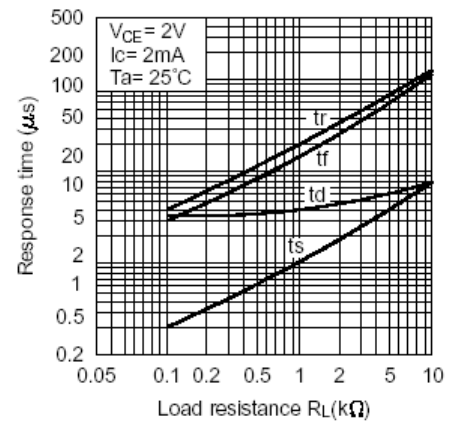
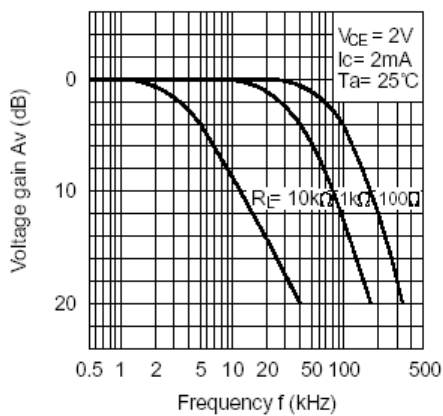
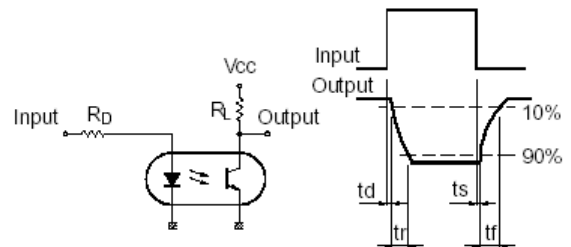

Fig.11 Frequency Response



Test Circuit for Response Time



Test Circuit for Frequency Response

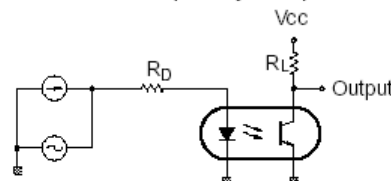



● 可靠度测试

分类	测试项目	参考标准	测试条件	结果
耐性测试	寿命测试	MIL-STD-750:1026 MIL-STD-883:1005 JIS C 7021 :B-1	连接功率是 $I_f=50\text{mA}$, 在室温下测试时间为 1000 小时	0/20
	高温高湿循环	JIS C 7021 :B-11	$T_a=+85^\circ\text{C}\pm 5^\circ\text{C}$, RH=85% PTR=VCE 绝对最大额定值 *80% 测试时间=1000hrs	0/20
	高温循环	JIS C 7021 :B- 8	$T_a=+105^\circ\text{C}\pm 5^\circ\text{C}$ PTR=VCE 绝对最大额定值 测试时间=1000hrs	0/20
	高温存贮	MIL-STD-883:1008 JIS C 7021 :B-10	高温= $+125^\circ\text{C}\pm 5^\circ\text{C}$ 测试时间=1,000hrs	0/20
	低温存贮	JIS-C-7021 :B-12	低温= $-55^\circ\text{C}\pm 5^\circ\text{C}$ 测试时间=1,000hrs	0/20
	高压加速寿命试验	JESD 22-A102-B	$P=15\text{PSIG}$, $T_a=121^\circ\text{C}$ 条件. =100%RH, 48hrs	0/20
环境测试	温度循环	MIL-STD-202:107D MIL-STD-750:1051 MIL-STD-883:1010 JIS C 7021 :A-4	$125^\circ\text{C} \sim 25^\circ\text{C} \sim -55^\circ\text{C} \sim 25^\circ\text{C}$ 30min 5min 30min 5min 测试时间=20cycle	0/20
	冷热冲击	MIL-STD-202:107D MIL-STD-750:1051 MIL-STD-883:1011	$125^\circ\text{C} \sim -55^\circ\text{C}$ 20min 20min 测试时间=20cycle	0/20
	焊锡实验	MIL-STD-202:201A MIL-STD-750:2031 JIS C 7021 :A-1	工作温度：260℃, 在 10 ± 1 秒内.	0/20
	沾锡实验	MIL-S-883:2003 JIS C 7021 :A-2	沾锡测试：235℃,在 5 ± 1 秒之内.	0/20

● 可靠度判断标准

符号	测试条件	失效标准判定
VF (V)	$I_f=20\text{mA}$	Over $U_x1.0$
$I_r(\text{uA})$	$V_r=4\text{V}$	Over $U_x1.0$
CTR(%)	$I_f=5\text{mA}$, $V_{CE}=5\text{V}$	Shift>1.2
$V_{CE}(\text{sat})$	$I_F=20\text{mA}$, $I_C= 1\text{mA}$	Over $U_x1.0$
BVCEO	$I_C=0.1\text{mA}$, $I_F=0$	Over $L_x1.0$
BVECO	$I_E=10\mu\text{A}$, $I_F=0$	Over $L_x1.0$