

LM22676/-Q1 42 V, 3 A SIMPLE SWITCHER® Step-Down Voltage Regulator with Features

1 Features

- Wide Input Voltage Range: 4.5 V to 42 V
- Internally Compensated Voltage Mode Control
- Stable with Low ESR Ceramic Capacitors
- 120 mΩ N-Channel MOSFET PFM Package
- 100 mΩ N-Channel MOSFET PSOP-8 Package
- Output Voltage Options:
 - ADJ (Outputs as Low as 1.285 V)
 - 5.0 (Output Fixed to 5 V)
- $\pm 1.5\%$ Feedback Reference Accuracy
- Switching Frequency of 500 kHz
- -40°C to 125°C Operating Junction Temperature Range
- Precision Enable Pin
- Integrated Boot-Strap Diode
- Integrated Soft-Start
- Fully WEBENCH® Enabled
- LM22676Q is an Automotive Grade Product that is AEC-Q100 Grade 1 Qualified (-40°C to $+125^{\circ}\text{C}$ Operating Junction Temperature)
- SO PowerPAD (Exposed Pad)
- PFM (Exposed Pad)

2 Applications

- Industrial Control
- Telecom and Datacom Systems
- Embedded Systems
- Conversions from Standard 24 V, 12 V and 5 V Input Rails

3 Description

The LM22676 switching regulator provides all of the functions necessary to implement an efficient high voltage step-down (buck) regulator using a minimum of external components. This easy to use regulator incorporates a 42 V N-channel MOSFET switch capable of providing up to 3 A of load current. Excellent line and load regulation along with high efficiency ($> 90\%$) are featured. Voltage mode control offers short minimum on-time, allowing the widest ratio between input and output voltages. Internal loop compensation means that the user is free from the tedious task of calculating the loop compensation components. Fixed 5 V output and adjustable output voltage options are available. A switching frequency of 500 kHz allows for small external components and good transient response. A precision enable input allows simplification of regulator control and system power sequencing. In shutdown mode the regulator draws only 25 μA (typ). Built in soft-start (500 μs , typ) saves external components. The LM22676 also has built in thermal shutdown, and current limiting to protect against accidental overloads.

The LM22676 is a member of Texas Instruments' SIMPLE SWITCHER® family. The SIMPLE SWITCHER® concept provides for an easy to use complete design using a minimum number of external components and the TI WEBENCH® design tool. TI's WEBENCH® tool includes features such as external component calculation, electrical simulation, thermal simulation, and Build-It boards for easy design-in.

Device Information⁽¹⁾

PART NUMBER	PACKAGE	BODY SIZE (NOM)
LM22676, LM22676-Q1	HSOP (8)	4.89 mm x 3.90 mm
	TO-263 (3)	10.16 mm x 9.85 mm

(1) For all available packages, see the orderable addendum at the end of the data sheet.

Simplified Application Schematic

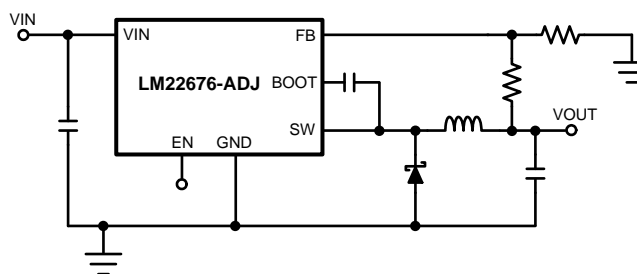

Table of Contents

1 Features 1 2 Applications 1 3 Description 1 4 Revision History 2 5 Pin Configuration and Functions 3 6 Specifications 4 6.1 Absolute Maximum Ratings 4 6.2 Handling Ratings: LM22676..... 4 6.3 Handling Ratings: LM22676-Q1 4 6.4 Recommended Operating Conditions 4 6.5 Thermal Information 4 6.6 Electrical Characteristics..... 5 6.7 Typical Characteristics 6 7 Detailed Description 8 7.1 Overview 8 7.2 Functional Block Diagram 8 7.3 Feature Description..... 8	7.4 Device Functional Modes..... 10 8 Application and Implementation 13 8.1 Application Information..... 13 8.2 Typical Application 14 9 Power Supply Recommendations 17 10 Layout 17 10.1 Layout Guidelines 17 10.2 Layout Examples..... 18 10.3 Thermal Considerations 19 11 Device and Documentation Support 20 11.1 Documentation Support 20 11.2 Related Links 20 11.3 Trademarks 20 11.4 Electrostatic Discharge Caution..... 20 11.5 Glossary 20 12 Mechanical, Packaging, and Orderable Information 20
--	--

4 Revision History

Changes from Revision K (April 2013) to Revision L	Page
<ul style="list-style-type: none"> • Added <i>Pin Configuration and Functions</i> section, <i>Handling Rating</i> table, <i>Thermal Information</i> table, <i>Feature Description</i> section, <i>Device Functional Modes</i>, <i>Application and Implementation</i> section, <i>Power Supply Recommendations</i> section, <i>Layout</i> section, <i>Device and Documentation Support</i> section, and <i>Mechanical, Packaging, and Orderable Information</i> section 	1

Changes from Revision J (April 2013) to Revision K	Page
<ul style="list-style-type: none"> • Changed from National format to TI format..... 	1

5 Pin Configuration and Functions

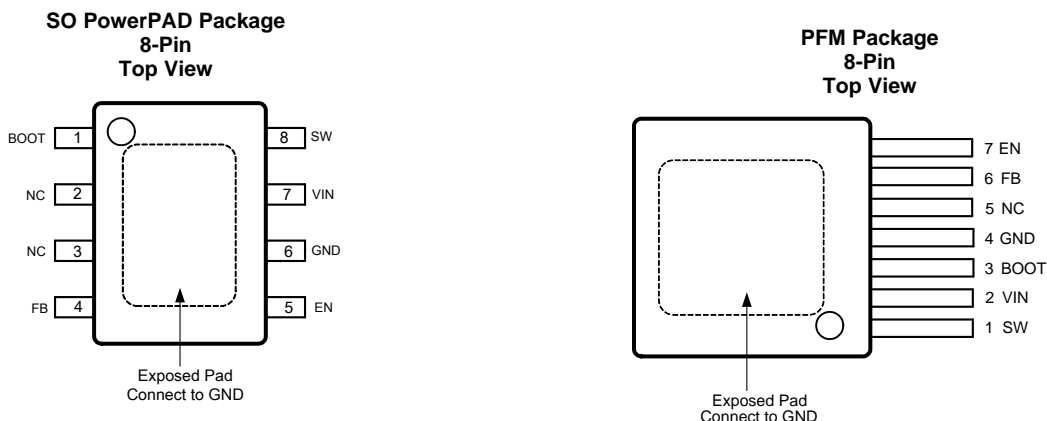

Pin Functions

NAME	PIN		TYPE	DESCRIPTION	APPLICATION INFORMATION
	SO PowerPAD	PFM			
BOOT	1	3	I	Bootstrap input	Provides the gate voltage for the high side N-FET.
NC	2, 3	5	—	Not Connected	Pins are not electrically connected inside the chip. Pins do function as thermal conductor.
FB	4	6	I	Feedback pin	Feedback input to regulator.
EN	5	7	I	Enable input	Used to control regulator start-up and shutdown. See Precision Enable and UVLO section of data sheet.
GND	6	4	—	Ground input to regulator; system common	System ground pin.
VIN	7	2	I	Input Voltage	Input supply to regulator
SW	8	1	O	Switch pin	Switching output of regulator
EP	EP	EP	—	Exposed Pad	Connect to ground. Provides thermal connection to PCB. See Thermal Considerations .

6 Specifications

6.1 Absolute Maximum Ratings⁽¹⁾⁽²⁾

	MIN	MAX	UNIT
V _{IN} to GND		43	V
EN Pin Voltage	-0.5	6	V
SW to GND ⁽³⁾	-5	V _{IN}	V
BOOT Pin Voltage		V _{SW} + 7	V
FB Pin Voltage	-0.5	7	V
Power Dissipation	Internally Limited		
Junction Temperature		150	°C

For soldering specifications, refer to Application Report *Absolute Maximum Ratings for Soldering* (SNOA549).

- (1) *Absolute Maximum Ratings* indicate limits beyond which damage to the device may occur, including inoperability and degradation of device reliability and/or performance. Functional operation of the device and/or non-degradation at the Absolute Maximum Ratings or other conditions beyond those indicated in the [Recommended Operating Conditions](#) is not implied. The Recommended Operating Conditions indicate conditions at which the device is functional and should not be operated beyond such conditions.
- (2) If Military/Aerospace specified devices are required, please contact the Texas Instruments Sales Office/Distributors for availability and specifications.
- (3) The absolute maximum specification of the 'SW to GND' applies to dc voltage. An extended negative voltage limit of -10 V applies to a pulse of up to 50 ns.

6.2 Handling Ratings: LM22676

	MIN	MAX	UNIT
T _{stg} Storage temperature range	-65	150	°C
V _(ESD) Electrostatic discharge	-2	2	kV
Human body model (HBM), per ANSI/ESDA/JEDEC JS-001, all pins ⁽¹⁾			

- (1) JEDEC document JEP155 states that 500-V HBM allows safe manufacturing with a standard ESD control process.

6.3 Handling Ratings: LM22676-Q1

	MIN	MAX	UNIT
T _{stg} Storage temperature range	-65	150	°C
V _(ESD) Electrostatic discharge	-2	2	kV
Human body model (HBM), per AEC Q100-002 ⁽¹⁾			

- (1) AEC Q100-002 indicates HBM stressing is done in accordance with the ANSI/ESDA/JEDEC JS-001 specification.

6.4 Recommended Operating Conditions

	MIN	MAX	UNIT
V _{IN} Supply Voltage	4.5	42	V
Junction Temperature	-40	125	°C

6.5 Thermal Information

THERMAL METRIC ⁽¹⁾	LM22676, LM22676-Q1		UNIT
	DDA	NDR	
	8 PINS	7 PINS	
R _{θJA} Junction-to-ambient thermal resistance	60	22	°C/W

- (1) For more information about traditional and new thermal metrics, see the *IC Package Thermal Metrics* application report, [SPRA953](#).

6.6 Electrical Characteristics

Typical values represent the most likely parametric norm at $T_A = T_J = 25^\circ\text{C}$, and are provided for reference purposes only. Unless otherwise specified: $V_{IN} = 12\text{ V}$.

PARAMETER		TEST CONDITIONS	MIN ⁽¹⁾	TYP ⁽²⁾	MAX ⁽¹⁾	UNIT
LM22676-5.0						
V_{FB}	Feedback Voltage	$V_{IN} = 8\text{ V to }42\text{ V}$	4.925	5.0	5.075	V
		$V_{IN} = 8\text{ V to }42\text{ V}, -40^\circ\text{C} \leq T_J \leq 125^\circ\text{C}$	4.9		5.1	
LM22676-ADJ						
V_{FB}	Feedback Voltage	$V_{IN} = 4.7\text{ V to }42\text{ V}$	1.266	1.285	1.304	V
		$V_{IN} = 4.7\text{ V to }42\text{ V}, -40^\circ\text{C} \leq T_J \leq 125^\circ\text{C}$	1.259		1.311	
ALL OUTPUT VOLTAGE VERSIONS						
I_Q	Quiescent Current	$V_{FB} = 5\text{ V}$		3.4		mA
		$V_{FB} = 5\text{ V}, -40^\circ\text{C} \leq T_J \leq 125^\circ\text{C}$			6	
I_{STDBY}	Standby Quiescent Current	EN Pin = 0 V		25	40	μA
I_{CL}	Current Limit		3.4	4.2	5.3	A
		$-40^\circ\text{C} \leq T_J \leq 125^\circ\text{C}$	3.35		5.5	
I_L	Output Leakage Current	$V_{IN} = 42\text{ V}, \text{EN Pin} = 0\text{ V}, V_{SW} = 0\text{ V}$		0.2	2	μA
		$V_{SW} = -1\text{ V}$		0.1	3	μA
$R_{DS(ON)}$	Switch On-Resistance	PFM Package		0.12	0.16	Ω
		PFM Package			0.22	
		SO PowerPAD Package		0.10	0.16	
		SO PowerPAD Package			0.20	
f_O	Oscillator Frequency			500		kHz
		$-40^\circ\text{C} \leq T_J \leq 125^\circ\text{C}$	400		600	
T_{OFFMIN}	Minimum Off-time			200		ns
		$-40^\circ\text{C} \leq T_J \leq 125^\circ\text{C}$	100		300	
T_{ONMIN}	Minimum On-time			100		ns
I_{BIAS}	Feedback Bias Current	$V_{FB} = 1.3\text{ V (ADJ Version Only)}$		230		nA
V_{EN}	Enable Threshold Voltage	Falling		1.6		V
		Falling, $-40^\circ\text{C} \leq T_J \leq 125^\circ\text{C}$	1.3		1.9	
V_{ENHYST}	Enable Voltage Hysteresis			0.6		V
I_{EN}	Enable Input Current	EN Input = 0 V		6		μA
T_{SD}	Thermal Shutdown Threshold			150		$^\circ\text{C}$

- (1) Min and Max limits are 100% production tested at 25°C . Limits over the operating temperature range are ensured through correlation using Statistical Quality Control (SQC) methods. Limits are used to calculate TI's Average Outgoing Quality Level (AOQL).
- (2) Typical values represent most likely parametric norms at the conditions specified and are not ensured.

6.7 Typical Characteristics

$V_{in} = 12\text{ V}$, $T_J = 25^\circ\text{C}$ (unless otherwise specified)

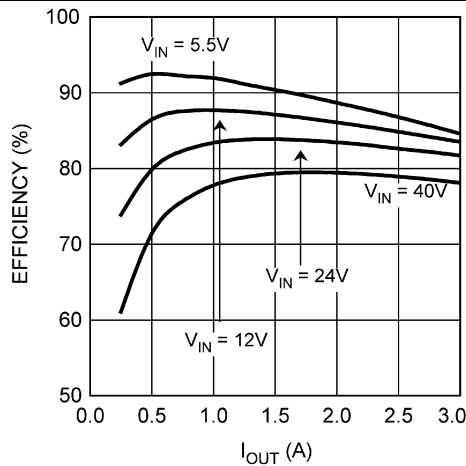

Figure 1. Efficiency vs I_{OUT} and V_{IN} , $V_{OUT} = 3.3\text{ V}$

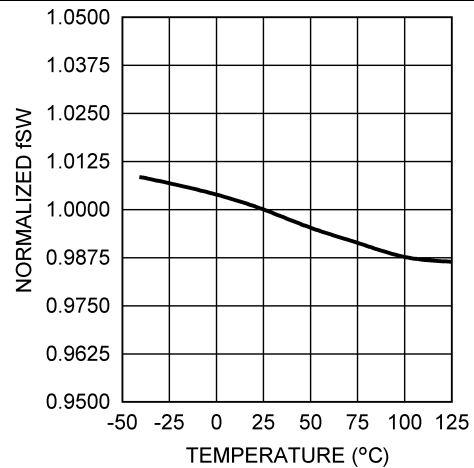

Figure 2. Normalized Switching Frequency vs Temperature

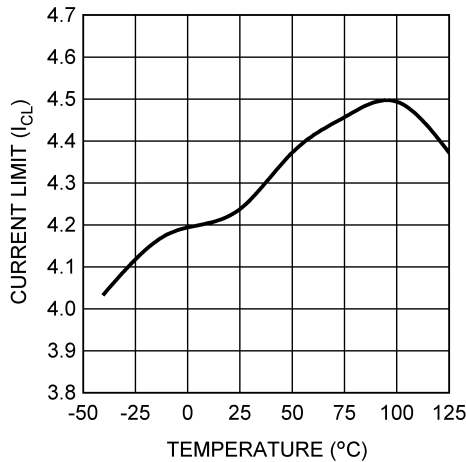

Figure 3. Current Limit vs Temperature

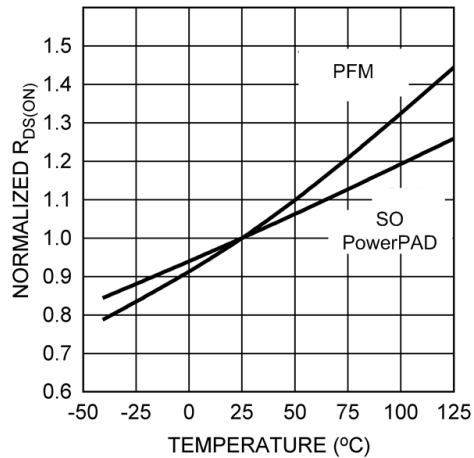

Figure 4. Normalized $R_{DS(ON)}$ vs Temperature

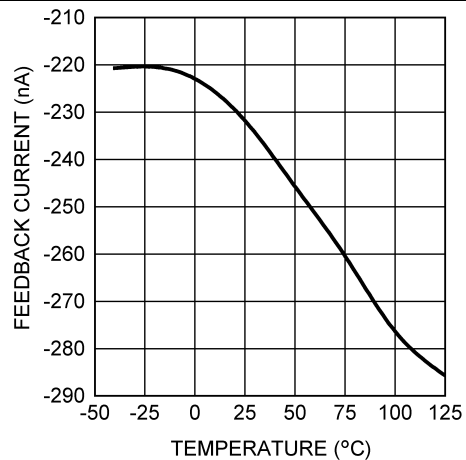

Figure 5. Feedback Bias Current vs Temperature

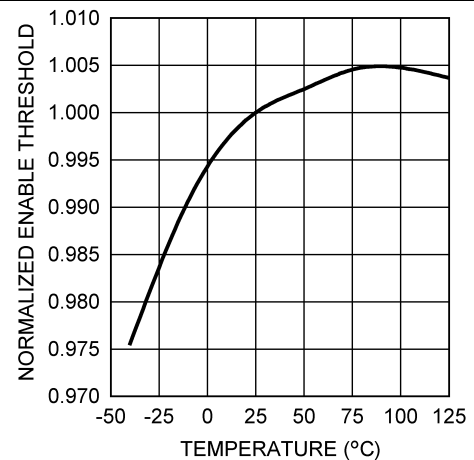

Figure 6. Normalized Enable Threshold Voltage vs Temperature

Typical Characteristics (continued)

$V_{in} = 12\text{ V}$, $T_J = 25^\circ\text{C}$ (unless otherwise specified)

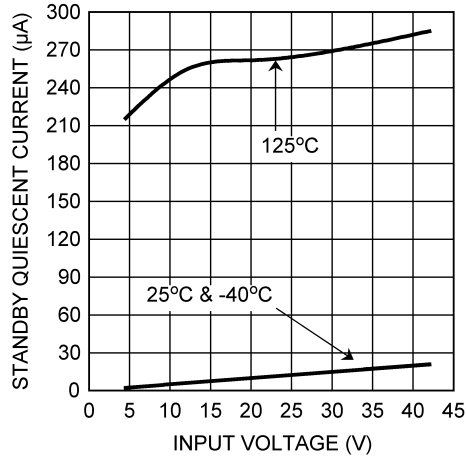

Figure 7. Standby Quiescent Current vs Input Voltage

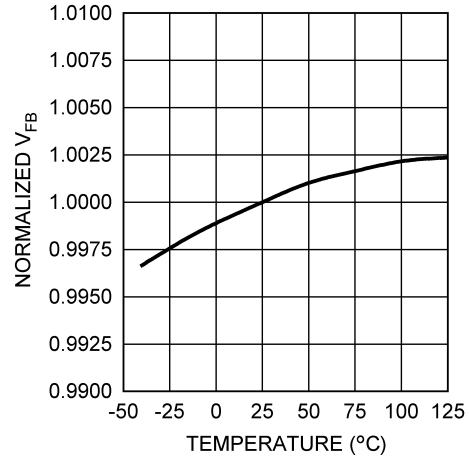

Figure 8. Normalized Feedback Voltage vs Temperature

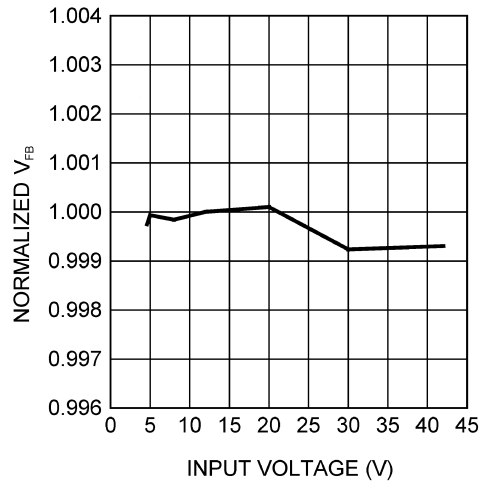

Figure 9. Normalized Feedback Voltage vs Input Voltage

7 Detailed Description

7.1 Overview

The LM22676 device incorporates a voltage mode constant frequency PWM architecture. In addition, input voltage feedforward is used to stabilize the loop gain against variations in input voltage. This allows the loop compensation to be optimized for transient performance. The power MOSFET, in conjunction with the diode, produce a rectangular waveform at the switch pin that swings from about zero volts to V_{IN} . The inductor and output capacitor average this waveform to become the regulator output voltage. By adjusting the duty cycle of this waveform, the output voltage can be controlled. The error amplifier compares the output voltage with the internal reference and adjusts the duty cycle to regulate the output at the desired value.

The internal loop compensation of the -ADJ option is optimized for outputs of 5 V and below. If an output voltage of 5 V or greater is required, the -5.0 option can be used with an external voltage divider. The minimum output voltage is equal to the reference voltage, that is, 1.285 V (typ).

7.2 Functional Block Diagram

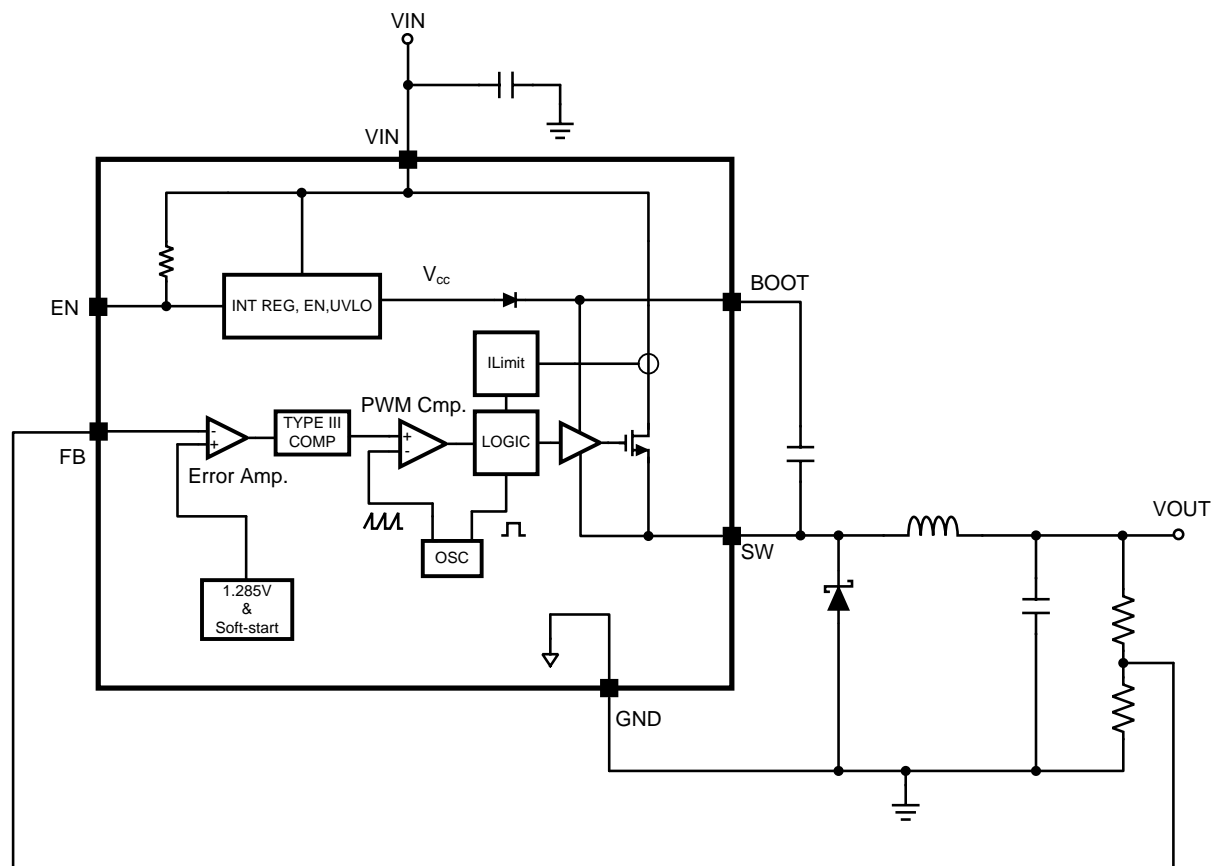

7.3 Feature Description

7.3.1 Precision Enable and UVLO

The precision enable input (EN) is used to control the regulator. The precision feature allows simple sequencing of multiple power supplies with a resistor divider from another supply. Connecting this pin to ground or to a voltage less than 1.6 V (typ) will turn off the regulator. The current drain from the input supply, in this state, is 25 μ A (typ) at an input voltage of 12 V. The EN input has an internal pullup of about 6 μ A. Therefore this pin can be left floating or pulled to a voltage greater than 2.2 V (typ) to turn the regulator on. The hysteresis on this input is about 0.6 V (typ) above the 1.6 V (typ) threshold. When driving the enable input, the voltage must never exceed the 6 V absolute maximum specification for this pin.

Feature Description (continued)

Although an internal pullup is provided on the EN pin, it is good practice to pull the input high, when this feature is not used, especially in noisy environments. This can most easily be done by connecting a resistor between VIN and the EN pin. The resistor is required, because the internal zener diode, at the EN pin, will conduct for voltages above about 6 V. The current in this zener must be limited to less than 100 μ A. A resistor of 470 k Ω will limit the current to a safe value for input voltages as high as 42 V. Smaller values of resistor can be used at lower input voltages.

The LM22676 also incorporates an input undervoltage lock-out (UVLO) feature. This prevents the regulator from turning on when the input voltage is not great enough to properly bias the internal circuitry. The rising threshold is 4.3 V (typ) while the falling threshold is 3.9 V (typ). In some cases these thresholds may be too low to provide good system performance. The solution is to use the EN input as an external UVLO to disable the part when the input voltage falls below a lower boundary. This is often used to prevent excessive battery discharge or early turn on during start up. This method is also recommended to prevent abnormal device operation in applications where the input voltage falls below the minimum of 4.5 V. [Figure 10](#) shows the connections to implement this method of UVLO. [Equation 1](#) and [Equation 2](#) can be used to determine the correct resistor values.

$$R_{ENT} = R_{ENB} \cdot \left(\frac{V_{off}}{V_{EN}} - 1 \right) \quad (1)$$

$$V_{on} = V_{off} \cdot \left(\frac{V_{EN} + V_{ENHYST}}{V_{EN}} \right) \quad (2)$$

Where:

V_{off} is the input voltage where the regulator shuts off.

V_{on} is the voltage where the regulator turns on.

Due to the 6 μ A pullup, the current in the divider should be much larger than this. A value of 20 k Ω , for R_{ENB} is a good first choice. Also, a zener diode may be needed between the EN pin and ground in order to comply with the absolute maximum ratings on this pin.

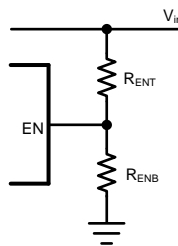

Figure 10. External UVLO Connections

7.3.2 Soft-Start

The soft-start feature allows the regulator to gradually reach steady-state operation, thus reducing start-up stresses. The internal soft-start feature brings the output voltage up in about 500 μ s. This time is fixed and can not be changed. Soft-start is reset any time the part is shut down or a thermal overload event occurs.

7.3.3 Boot-Strap Supply

The LM22676 incorporates a floating high-side gate driver to control the power MOSFET. The supply for this driver is the external boot-strap capacitor connected between the BOOT pin and SW. A good quality 10 nF ceramic capacitor must be connected to these pins with short, wide PCB traces. One reason the regulator imposes a minimum off-time is to ensure that this capacitor recharges every switching cycle. A minimum load of about 5 mA is required to fully recharge the boot-strap capacitor in the minimum off-time. Some of this load can be provided by the output voltage divider, if used.

Feature Description (continued)

7.3.4 Internal Compensation

The LM22676 device has internal loop compensation designed to provide a stable regulator over a wide range of external power stage components.

The internal compensation of the -ADJ option is optimized for output voltages below 5 V. If an output voltage of 5 V or greater is needed, the -5.0 option with an external resistor divider can be used.

Ensuring stability of a design with a specific power stage (inductor and output capacitor) can be tricky. The LM22676 stability can be verified using the [WEBENCH Designer](#) online circuit simulation tool. A quick start spreadsheet can also be downloaded from the online product folder.

The complete transfer function for the regulator loop is found by combining the compensation and power stage transfer functions. The LM22676 has internal type III loop compensation, as detailed in [Figure 11](#). This is the approximate "straight line" function from the FB pin to the input of the PWM modulator. The power stage transfer function consists of a dc gain and a second order pole created by the inductor and output capacitor(s). Due to the input voltage feedforward employed in the LM22676, the power stage dc gain is fixed at 20 dB. The second order pole is characterized by its resonant frequency and its quality factor (Q). For a first pass design, the product of inductance and output capacitance should conform to [Equation 3](#).

$$L \cdot C_{OUT} \approx 1.1 \times 10^{-9} \tag{3}$$

Alternatively, this pole should be placed between 1.5 kHz and 15 kHz and is determined by [Equation 4](#).

$$F_o = \frac{1}{2\pi \cdot \sqrt{L \cdot C_{out}}} \tag{4}$$

The Q factor depends on the parasitic resistance of the power stage components and is not typically in the control of the designer. Of course, loop compensation is only one consideration when selecting power stage components; see the [Application Information](#) section for more details.

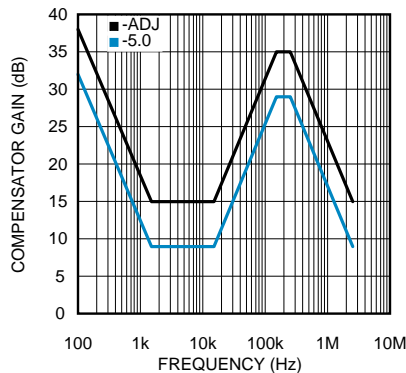

Figure 11. Compensator Gain

In general, hand calculations or simulations can only aid in selecting good power stage components. Good design practice dictates that load and line transient testing should be done to verify the stability of the application. Also, Bode plot measurements should be made to determine stability margins. *AN-1889 How to Measure the Loop Transfer Function of Power Supplies (SNVA364)* shows how to perform a loop transfer function measurement with only an oscilloscope and function generator.

7.4 Device Functional Modes

7.4.1 Current Limit

The LM22676 has current limiting to prevent the switch current from exceeding safe values during an accidental overload on the output. This peak current limit is found in the [Electrical Characteristics](#) under the heading of I_{CL} . The maximum load current that can be provided, before current limit is reached, is determined from [Equation 5](#).

Device Functional Modes (continued)

$$I_{out|_{max}} \approx I_{CL} - \frac{(V_{in} - V_{out})}{2 \cdot L \cdot F_{sw}} \cdot \frac{V_{out}}{V_{in}} \quad (5)$$

Where:

L is the value of the power inductor.

When the LM22676 enters current limit, the output voltage will drop and the peak inductor current will be fixed at I_{CL} at the end of each cycle.

The switching frequency will remain constant while the duty cycle drops. The load current will not remain constant, but will depend on the severity of the overload and the output voltage.

For very severe overloads ("short-circuit"), the regulator changes to a low frequency current foldback mode of operation. The frequency foldback is about 1/5 of the nominal switching frequency. This will occur when the current limit trips before the minimum on-time has elapsed. This mode of operation is used to prevent inductor current "run-away", and is associated with very low output voltages when in overload. [Equation 6](#) can be used to determine what level of output voltage will cause the part to change to low frequency current foldback.

$$V_x \leq V_{in} \cdot F_{sw} \cdot T_{on} \cdot 1.8 \quad (6)$$

Where:

F_{sw} is the normal switching frequency.

V_{in} is the maximum for the application.

If the overload drives the output voltage to less than or equal to V_x , the part will enter current foldback mode. If a given application can drive the output voltage to $\leq V_x$, during an overload, then a second criterion must be checked. [Equation 7](#) gives the maximum input voltage, when in this mode, before damage occurs.

$$V_{in} \leq \frac{V_{sc} + 0.4}{T_{on} \cdot F_{sw}} \cdot 0.36 \quad (7)$$

Where:

V_{sc} is the value of output voltage during the overload.

F_{sw} is the normal switching frequency.

NOTE

If the input voltage should exceed this value, while in foldback mode, the regulator and/or the diode may be damaged.

It is important to note that the voltages in these equations are measured at the inductor. Normal trace and wiring resistance will cause the voltage at the inductor to be higher than that at a remote load. Therefore, even if the load is shorted with zero volts across its terminals, the inductor will still see a finite voltage. It is this value that should be used for V_x and V_{sc} in the calculations. In order to return from foldback mode, the load must be reduced to a value much lower than that required to initiate foldback. This load "hysteresis" is a normal aspect of any type of current limit foldback associated with voltage regulators.

The safe operating area, when in short circuit mode, is shown in [Figure 12](#). Operating points below and to the right of the curve represent safe operation.

Device Functional Modes (continued)

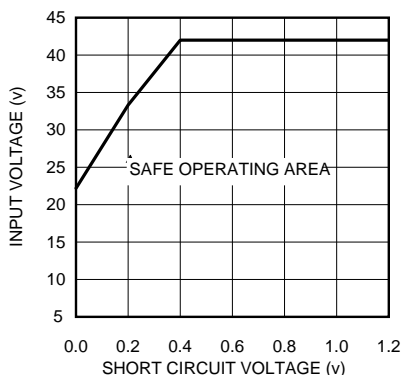

Figure 12. SOA

7.4.2 Thermal Protection

Internal thermal shutdown circuitry protects the LM22676 should the maximum junction temperature be exceeded. This protection is activated at about 150°C, with the result that the regulator will shutdown until the temperature drops below about 135°C.

7.4.3 Duty-Cycle Limits

Ideally the regulator would control the duty cycle over the full range of zero to one. However due to inherent delays in the circuitry, there are limits on both the maximum and minimum duty cycles that can be reliably controlled. This in turn places limits on the maximum and minimum input and output voltages that can be converted by the LM22676. A minimum on-time is imposed by the regulator in order to correctly measure the switch current during a current limit event. A minimum off-time is imposed in order to re-charge the bootstrap capacitor. Equation 8 can be used to determine the approximate maximum input voltage for a given output voltage.

$$V_{in|_{max}} \approx \frac{V_{out} + 0.4}{T_{on} \cdot F_{sw} \cdot 1.8} \quad (8)$$

Where:

F_{sw} is the switching frequency.

T_{ON} is the minimum on-time.

Both parameters may be found in the [Electrical Characteristics](#).

The worst case occurs at the lowest output voltage. If the input voltage, found in the above equation, is exceeded, the regulator will skip cycles, effectively lowering the switching frequency. The consequences of this are higher output voltage ripple and a degradation of the output voltage accuracy.

The second limitation is the maximum duty cycle before the output voltage will "dropout" of regulation. Equation 9 can be used to approximate the minimum input voltage before dropout occurs.

$$V_{in|_{min}} \approx \frac{V_{out} + 0.4 + I_{out} \cdot R_L}{1 - T_{off} \cdot F_{sw} \cdot 1.8} + I_{out} \cdot R_{dson} \quad (9)$$

Where:

The values of T_{OFF} and $R_{DS(ON)}$ are found in the [Electrical Characteristics](#).

The worst case here occurs at the highest load. In this equation, R_L is the dc inductor resistance. Of course, the lowest input voltage to the regulator must not be less than 4.5 V (typ).

8 Application and Implementation

NOTE

Information in the following applications sections is not part of the TI component specification, and TI does not warrant its accuracy or completeness. TI's customers are responsible for determining suitability of components for their purposes. Customers should validate and test their design implementation to confirm system functionality.

8.1 Application Information

The LM22676 is a step down dc-to-dc regulator. It is typically used to convert a higher dc voltage to a lower dc voltage with a maximum output current of 3 A. The following design procedure can be used to select components for the LM22676. Alternately, the WEBENCH® software may be used to generate complete designs.

When generating a design, the WEBENCH® software utilizes iterative design procedure and accesses comprehensive databases of components. Go to [WEBENCH Designer](#) for more details.

8.1.1 Output Voltage Divider Selection

For output voltages between about 1.285 V and 5 V, the -ADJ option should be used, with an appropriate voltage divider as shown in [Figure 13](#). [Equation 10](#) can be used to calculate the resistor values of this divider.

$$R_{FBT} = \left[\frac{V_{out}}{1.285} - 1 \right] \cdot R_{FBB} \quad (10)$$

A good value for R_{FBB} is 1 kΩ. This will help to provide some of the minimum load current requirement and reduce susceptibility to noise pick-up. The top of R_{FBT} should be connected directly to the output capacitor or to the load for remote sensing. If the divider is connected to the load, a local high-frequency bypass should be provided at that location.

For output voltages of 5 V, the -5.0 option should be used. In this case no divider is needed and the FB pin is connected to the output. The approximate values of the internal voltage divider are as follows: 7.38 kΩ from the FB pin to the input of the error amplifier and 2.55 kΩ from there to ground.

Both the -ADJ and -5.0 options can be used for output voltages greater than 5 V, by using the correct output divider. As mentioned in the [Internal Compensation](#) section, the -5.0 option is optimized for output voltages of 5 V. However, for output voltages greater than 5 V, this option may provide better loop bandwidth than the -ADJ option, in some applications. If the -5.0 option is to be used at output voltages greater than 5 V, [Equation 11](#) should be used to determine the resistor values in the output divider.

$$R_{FBT} = \frac{R_{FBB} \cdot (V_{out} - 5)}{5 + R_{FBB} \cdot 5 \times 10^{-4}} \quad (11)$$

A value of R_{FBB} of about 1 kΩ is a good first choice.

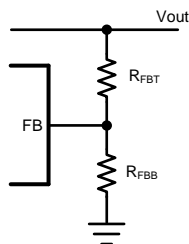

Figure 13. Resistive Feedback Divider

A maximum value of 10 kΩ is recommended for the sum of R_{FBB} and R_{FBT} to maintain good output voltage accuracy for the -ADJ option. A maximum of 2 kΩ is recommended for the -5.0 option. For the -5.0 option, the total internal divider resistance is typically 9.93 kΩ.

Application Information (continued)

In all cases the output voltage divider should be placed as close as possible to the FB pin of the LM22676, because this is a high impedance input and is susceptible to noise pick-up.

8.1.2 Power Diode

A Schottky-type power diode is required for all LM22676 applications. Ultra-fast diodes are not recommended and may result in damage to the IC due to reverse recovery current transients. The near ideal reverse recovery characteristics and low forward voltage drop of Schottky diodes are particularly important for high input voltage and low output voltage applications common to the LM22676. The reverse breakdown rating of the diode should be selected for the maximum V_{IN} , plus some safety margin. A good rule of thumb is to select a diode with a reverse voltage rating of 1.3 times the maximum input voltage.

Select a diode with an average current rating at least equal to the maximum load current that will be seen in the application.

8.2 Typical Application

8.2.1 Typical Buck Regulator Application

Figure 14 shows an example of converting an input voltage range of 5.5 V to 42 V, to an output of 3.3 V at 3 A.

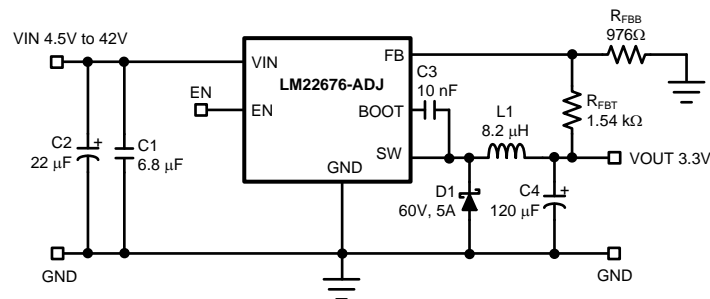

Figure 14. Typical Buck Regulator Application

8.2.1.1 Design Requirements

DESIGN PARAMETERS	EXAMPLE VALUE
Driver Supply Voltage (VIN)	4.5 to 42 V
Output Voltage (VOUT)	3.3 V
R_{FBT}	Calculated based on R_{FBB} and V_{REF} of 1.285 V.
R_{FBB}	1 kΩ to 10 kΩ
I_{OUT}	3 A

8.2.1.2 Detailed Design Procedure

8.2.1.2.1 External Components

The following guidelines should be used when designing a step-down (buck) converter with the LM22676.

8.2.1.2.2 Inductor

The inductor value is determined based on the load current, ripple current, and the minimum and maximum input voltages. To keep the application in continuous conduction mode (CCM), the maximum ripple current, I_{RIPPLE} , should be less than twice the minimum load current. The general rule of keeping the inductor current peak-to-peak ripple around 30% of the nominal output current is a good compromise between excessive output voltage ripple and excessive component size and cost. Using this value of ripple current, the value of inductor, L , is calculated using [Equation 12](#).

$$L = \frac{(V_{\text{in}} - V_{\text{out}}) \cdot V_{\text{out}}}{0.3 \cdot I_{\text{out}} \cdot F_{\text{sw}} \cdot V_{\text{in}}} \quad (12)$$

Where:

F_{sw} is the switching frequency.

V_{in} should be taken at its maximum value, for the given application.

[Equation 12](#) provides a guide to select the value of the inductor L ; the nearest standard value will then be used in the circuit.

Once the inductor is selected, the actual ripple current can be found from [Equation 13](#):

$$\Delta I = \frac{(V_{\text{in}} - V_{\text{out}}) \cdot V_{\text{out}}}{L \cdot F_{\text{sw}} \cdot V_{\text{in}}} \quad (13)$$

Increasing the inductance will generally slow down the transient response but reduce the output voltage ripple. Reducing the inductance will generally improve the transient response but increase the output voltage ripple.

The inductor must be rated for the peak current, I_{PK} , in a given application, to prevent saturation. During normal loading conditions, the peak current is equal to the load current plus 1/2 of the inductor ripple current.

During an overload condition, as well as during certain load transients, the controller may trip current limit. In this case the peak inductor current is given by I_{CL} , found in the [Electrical Characteristics](#) table. Good design practice requires that the inductor rating be adequate for this overload condition.

NOTE

If the inductor is not rated for the maximum expected current, it can saturate resulting in damage to the LM22676 and/or the power diode.

8.2.1.2.3 Input Capacitor

The input capacitor selection is based on both input voltage ripple and RMS current. Good quality input capacitors are necessary to limit the ripple voltage at the VIN pin while supplying most of the regulator current during switch on-time. Low ESR ceramic capacitors are preferred. Larger values of input capacitance are desirable to reduce voltage ripple and noise on the input supply. This noise may find its way into other circuitry, sharing the same input supply, unless adequate bypassing is provided. A very approximate formula for determining the input voltage ripple is shown in [Equation 14](#).

$$V_{\text{ri}} \approx \frac{I_{\text{out}}}{4 \cdot F_{\text{sw}} \cdot C_{\text{in}}} \quad (14)$$

Where:

V_{ri} is the peak-to-peak ripple voltage at the switching frequency.

Another concern is the RMS current passing through this capacitor. [Equation 15](#) gives an approximation to this current.

$$I_{\text{rms}} \approx \frac{I_{\text{out}}}{2} \quad (15)$$

The capacitor must be rated for at least this level of RMS current at the switching frequency.

All ceramic capacitors have large voltage coefficients, in addition to normal tolerances and temperature coefficients. To help mitigate these effects, multiple capacitors can be used in parallel to bring the minimum capacitance up to the desired value. This may also help with RMS current constraints by sharing the current among several capacitors. Many times it is desirable to use an electrolytic capacitor on the input, in parallel with the ceramics. The moderate ESR of this capacitor can help to damp any ringing on the input supply caused by long power leads. This method can also help to reduce voltage spikes that may exceed the maximum input voltage rating of the LM22676.

It is good practice to include a high frequency bypass capacitor as close as possible to the LM22676. This small case size, low ESR, ceramic capacitor should be connected directly to the VIN and GND pins with the shortest possible PCB traces. Values in the range of 0.47 μF to 1 μF are appropriate. This capacitor helps to provide a low impedance supply to sensitive internal circuitry. It also helps to suppress any fast noise spikes on the input supply that may lead to increased EMI.

8.2.1.2.4 Output Capacitor

The output capacitor is responsible for filtering the output voltage and supplying load current during transients. Capacitor selection depends on application conditions as well as ripple and transient requirements. Best performance is achieved with a parallel combination of ceramic capacitors and a low ESR SPT™ or POSCAP™ type. Very low ESR capacitors such as ceramics reduce the output ripple and noise spikes, while higher value electrolytics or polymer provide large bulk capacitance to supply transients. Assuming very low ESR, Equation 16 gives an approximation to the output voltage ripple.

$$V_{ro} \approx \frac{(V_{in} - V_{out}) \cdot V_{out}}{8 \cdot V_{in}} \cdot \frac{1}{F_{sw}^2 \cdot L \cdot C_{out}} \quad (16)$$

Typically, a total value of 100 μF , or greater is recommended for output capacitance.

In applications with V_{out} less than 3.3 V, it is critical that low ESR output capacitors are selected. This will limit potential output voltage overshoots as the input voltage falls below the device normal operating range.

8.2.1.2.5 Boot-Strap Capacitor

The bootstrap capacitor between the BOOT pin and the SW pin supplies the gate current to turn on the N-channel MOSFET. The recommended value of this capacitor is 10 nF and should be a good quality, low ESR ceramic capacitor. In some cases it may be desirable to slow down the turn on of the internal power MOSFET, in order to reduce EMI. This can be done by placing a small resistor in series with the C_{boot} capacitor. Resistors in the range of 10 Ω to 50 Ω can be used. This technique should only be used when absolutely necessary, because it will increase switching losses and thereby reduce efficiency.

8.2.1.3 Application Curves

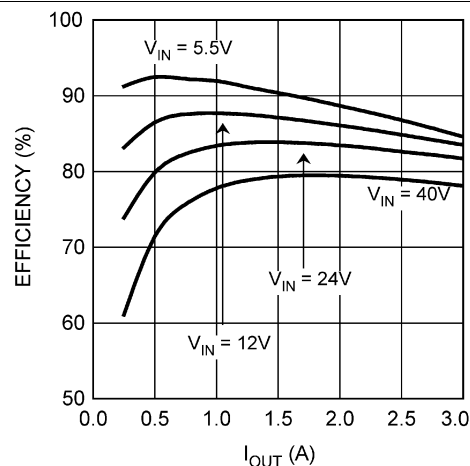

Figure 15. Efficiency vs I_{OUT} and V_{IN} , $V_{OUT} = 3.3\text{ V}$

9 Power Supply Recommendations

The LM22676 is designed to operate from an input voltage supply range between 4.5 V and 42 V. This input supply should be able to withstand the maximum input current and maintain a voltage above 4.5 V. The resistance of the input supply rail should be low enough that an input current transient does not cause a high enough drop at the LM22676 supply voltage that can cause a false UVLO fault triggering and system reset.

If the input supply is located more than a few inches from the LM22676 additional bulk capacitance may be required in addition to the ceramic bypass capacitors. The amount of bulk capacitance is not critical, but a 47 μF or 100 μF electrolytic capacitor is a typical choice.

10 Layout

10.1 Layout Guidelines

Board layout is critical for the proper operation of switching power supplies. First, the ground plane area must be sufficient for thermal dissipation purposes. Second, appropriate guidelines must be followed to reduce the effects of switching noise. Switch mode converters are very fast switching devices. In such cases, the rapid increase of input current combined with the parasitic trace inductance generates unwanted $L di/dt$ noise spikes. The magnitude of this noise tends to increase as the output current increases. This noise may turn into electromagnetic interference (EMI) and can also cause problems in device performance. Therefore, care must be taken in layout to minimize the effect of this switching noise.

The most important layout rule is to keep the ac current loops as small as possible. Figure 16 shows the current flow in a buck converter. The top schematic shows a dotted line which represents the current flow during the FET switch on-state. The middle schematic shows the current flow during the FET switch off-state.

The bottom schematic shows the currents referred to as ac currents. These ac currents are the most critical because they are changing in a very short time period. The dotted lines of the bottom schematic are the traces to keep as short and wide as possible. This will also yield a small loop area reducing the loop inductance. To avoid functional problems due to layout, review the PCB layout example. Best results are achieved if the placement of the LM22676, the bypass capacitor, the Schottky diode, R_{FBB} , R_{FBT} , and the inductor are placed as shown in the example. Note that, in the layout shown, $R1 = R_{FBB}$ and $R2 = R_{FBT}$. It is also recommended to use 2 oz copper boards or heavier to help thermal dissipation and to reduce the parasitic inductances of board traces. See AN-1229 SIMPLE SWITCHER[®] PCB Layout Guidelines (SNVA054) for more information.

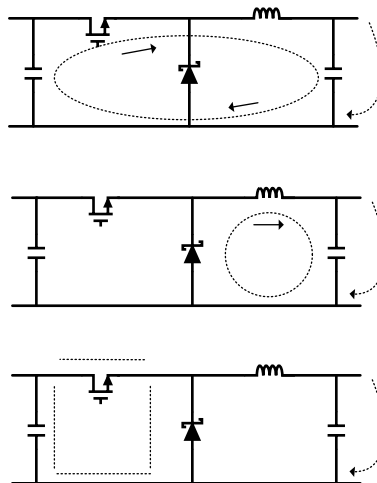

Figure 16. Current Flow in a Buck Application

10.2 Layout Examples

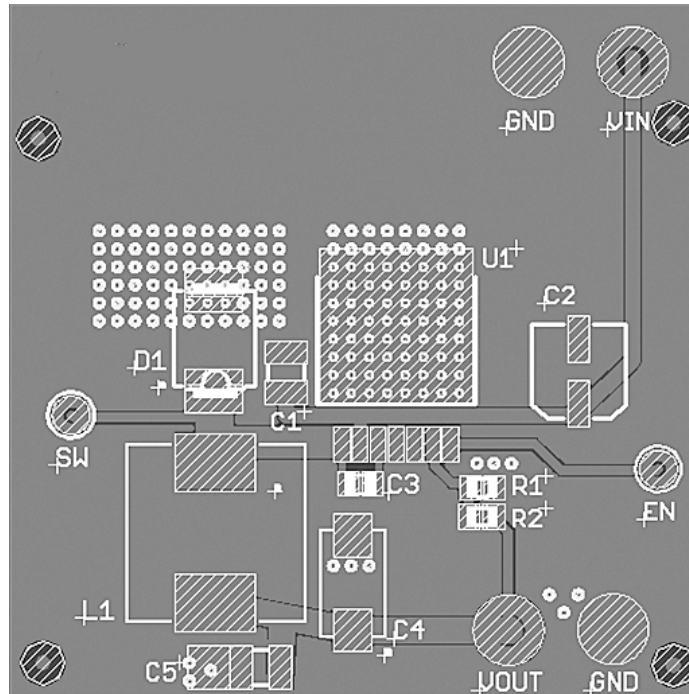

Figure 17. PCB Layout Example for PFM Package

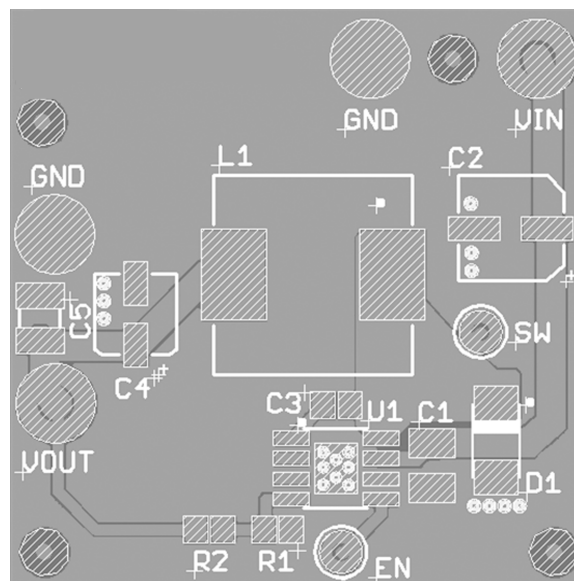

Figure 18. PCB Layout Example for SO PowerPAD Package

10.3 Thermal Considerations

The components with the highest power dissipation are the power diode and the power MOSFET internal to the LM22676 regulator. The easiest method to determine the power dissipation within the LM22676 is to measure the total conversion losses then subtract the power losses in the diode and inductor. The total conversion loss is the difference between the input power and the output power. An approximation for the power diode loss is shown in [Equation 17](#).

$$P_D = I_{out} \cdot V_D \cdot \left[1 - \frac{V_{out}}{V_{in}} \right] \quad (17)$$

Where:

V_D is the diode voltage drop.

An approximation for the inductor power is shown in [Equation 18](#).

$$P_D = I_{out} \cdot V_D \cdot \left[1 - \frac{V_{out}}{V_{in}} \right] \quad (18)$$

Where:

R_L is the dc resistance of the inductor.

The 1.1 factor is an approximation for the ac losses.

The regulator has an exposed thermal pad to aid power dissipation. Adding multiple vias under the device to the ground plane will greatly reduce the regulator junction temperature. Selecting a diode with an exposed pad will also aid the power dissipation of the diode. The most significant variables that affect the power dissipation of the regulator are output current, input voltage and operating frequency. The power dissipated while operating near the maximum output current and maximum input voltage can be appreciable. The junction-to-ambient thermal resistance of the LM22676 will vary with the application. The most significant variables are the area of copper in the PC board, the number of vias under the IC exposed pad and the amount of forced air cooling provided. A large continuous ground plane on the top or bottom PCB layer will provide the most effective heat dissipation. The integrity of the solder connection from the IC exposed pad to the PC board is critical. Excessive voids will greatly diminish the thermal dissipation capacity. The junction-to-ambient thermal resistance of the LM22676 SO PowerPAD package is specified in the [Electrical Characteristics](#) table. See *AN-2020 Thermal Design By Insight, Not Hindsight* ([SNVA419](#)) for more information.

11 Device and Documentation Support

11.1 Documentation Support

11.1.1 Related Documentation

- *AN-1889 How to Measure the Loop Transfer Function of Power Supplies* ([SNVA364](#))
- *AN-1885 LM22670 Evaluation Board* ([SNVA361](#))
- *AN-1229 SIMPLE SWITCHER® PCB Layout Guidelines* ([SNVA054](#))
- *AN-2020 Thermal Design By Insight, Not Hindsight* ([SNVA419](#))

11.2 Related Links

The table below lists quick access links. Categories include technical documents, support and community resources, tools and software, and quick access to sample or buy.

Table 1. Related Links

PARTS	PRODUCT FOLDER	SAMPLE & BUY	TECHNICAL DOCUMENTS	TOOLS & SOFTWARE	SUPPORT & COMMUNITY
LM22676	Click here	Click here	Click here	Click here	Click here
LM22676-Q1	Click here	Click here	Click here	Click here	Click here

11.3 Trademarks

WEBENCH, SIMPLE SWITCHER are registered trademarks of Texas Instruments. All other trademarks are the property of their respective owners.

11.4 Electrostatic Discharge Caution



These devices have limited built-in ESD protection. The leads should be shorted together or the device placed in conductive foam during storage or handling to prevent electrostatic damage to the MOS gates.

11.5 Glossary

[SLYZ022](#) — *TI Glossary*.

This glossary lists and explains terms, acronyms, and definitions.

12 Mechanical, Packaging, and Orderable Information

The following pages include mechanical, packaging, and orderable information. This information is the most current data available for the designated devices. This data is subject to change without notice and revision of this document. For browser-based versions of this data sheet, refer to the left-hand navigation.

PACKAGING INFORMATION

Orderable Device	Status (1)	Package Type	Package Drawing	Pins	Package Qty	Eco Plan (2)	Lead/Ball Finish (6)	MSL Peak Temp (3)	Op Temp (°C)	Device Marking (4/5)	Samples
LM22676MR-5.0/NOPB	ACTIVE	SO PowerPAD	DDA	8	95	Green (RoHS & no Sb/Br)	CU SN	Level-3-260C-168 HR	-40 to 125	L22676 5.0	Samples
LM22676MR-ADJ/NOPB	ACTIVE	SO PowerPAD	DDA	8	95	Green (RoHS & no Sb/Br)	CU SN	Level-3-260C-168 HR	-40 to 125	L22676 ADJ	Samples
LM22676MRE-5.0/NOPB	ACTIVE	SO PowerPAD	DDA	8	250	Green (RoHS & no Sb/Br)	CU SN	Level-3-260C-168 HR	-40 to 125	L22676 5.0	Samples
LM22676MRE-ADJ/NOPB	ACTIVE	SO PowerPAD	DDA	8	250	Green (RoHS & no Sb/Br)	CU SN	Level-3-260C-168 HR	-40 to 125	L22676 ADJ	Samples
LM22676MRX-5.0/NOPB	ACTIVE	SO PowerPAD	DDA	8	2500	Green (RoHS & no Sb/Br)	CU SN	Level-3-260C-168 HR	-40 to 125	L22676 5.0	Samples
LM22676MRX-ADJ/NOPB	ACTIVE	SO PowerPAD	DDA	8	2500	Green (RoHS & no Sb/Br)	CU SN	Level-3-260C-168 HR	-40 to 125	L22676 ADJ	Samples
LM22676QMR-5.0/NOPB	ACTIVE	SO PowerPAD	DDA	8	95	Green (RoHS & no Sb/Br)	CU SN	Level-3-260C-168 HR	-40 to 125	L22676 Q5.0	Samples
LM22676QMR-ADJ/NOPB	ACTIVE	SO PowerPAD	DDA	8	95	Green (RoHS & no Sb/Br)	CU SN	Level-3-260C-168 HR	-40 to 125	L22676 QADJ	Samples
LM22676QMRE-5.0/NOPB	ACTIVE	SO PowerPAD	DDA	8	250	Green (RoHS & no Sb/Br)	CU SN	Level-3-260C-168 HR	-40 to 125	L22676 Q5.0	Samples
LM22676QMRE-ADJ/NOPB	ACTIVE	SO PowerPAD	DDA	8	250	Green (RoHS & no Sb/Br)	CU SN	Level-3-260C-168 HR	-40 to 125	L22676 QADJ	Samples
LM22676QMRX-5.0/NOPB	ACTIVE	SO PowerPAD	DDA	8	2500	Green (RoHS & no Sb/Br)	CU SN	Level-3-260C-168 HR	-40 to 125	L22676 Q5.0	Samples
LM22676QMRX-ADJ/NOPB	ACTIVE	SO PowerPAD	DDA	8	2500	Green (RoHS & no Sb/Br)	CU SN	Level-3-260C-168 HR	-40 to 125	L22676 QADJ	Samples
LM22676QTJ-5.0/NOPB	ACTIVE	TO-263	NDR	7	1000	Green (RoHS & no Sb/Br)	CU SN	Level-1-260C-UNLIM	-40 to 125	LM22676 QTJ-5.0	Samples
LM22676QTJ-ADJ/NOPB	ACTIVE	TO-263	NDR	7	1000	Green (RoHS & no Sb/Br)	CU SN	Level-1-260C-UNLIM	-40 to 125	LM22676 QTJ-ADJ	Samples
LM22676QTJE-5.0/NOPB	ACTIVE	TO-263	NDR	7	250	Green (RoHS & no Sb/Br)	CU SN	Level-1-260C-UNLIM	-40 to 125	LM22676 QTJ-5.0	Samples
LM22676QTJE-ADJ/NOPB	ACTIVE	TO-263	NDR	7	250	Green (RoHS & no Sb/Br)	CU SN	Level-1-260C-UNLIM	-40 to 125	LM22676 QTJ-ADJ	Samples
LM22676TJ-5.0/NOPB	ACTIVE	TO-263	NDR	7	1000	Green (RoHS & no Sb/Br)	CU SN	Level-1-260C-UNLIM	-40 to 125	LM22676 TJ-5.0	Samples

Orderable Device	Status (1)	Package Type	Package Drawing	Pins	Package Qty	Eco Plan (2)	Lead/Ball Finish (6)	MSL Peak Temp (3)	Op Temp (°C)	Device Marking (4/5)	Samples
LM22676TJ-ADJ/NOPB	ACTIVE	TO-263	NDR	7	1000	Green (RoHS & no Sb/Br)	CU SN	Level-1-260C-UNLIM	-40 to 125	LM22676 TJ-ADJ	Samples
LM22676TJE-5.0/NOPB	ACTIVE	TO-263	NDR	7	250	Green (RoHS & no Sb/Br)	CU SN	Level-1-260C-UNLIM	-40 to 125	LM22676 TJ-5.0	Samples
LM22676TJE-ADJ/NOPB	ACTIVE	TO-263	NDR	7	250	Green (RoHS & no Sb/Br)	CU SN	Level-1-260C-UNLIM	-40 to 125	LM22676 TJ-ADJ	Samples

(1) The marketing status values are defined as follows:

ACTIVE: Product device recommended for new designs.

LIFEBUY: TI has announced that the device will be discontinued, and a lifetime-buy period is in effect.

NRND: Not recommended for new designs. Device is in production to support existing customers, but TI does not recommend using this part in a new design.

PREVIEW: Device has been announced but is not in production. Samples may or may not be available.

OBSOLETE: TI has discontinued the production of the device.

(2) Eco Plan - The planned eco-friendly classification: Pb-Free (RoHS), Pb-Free (RoHS Exempt), or Green (RoHS & no Sb/Br) - please check <http://www.ti.com/productcontent> for the latest availability information and additional product content details.

TBD: The Pb-Free/Green conversion plan has not been defined.

Pb-Free (RoHS): TI's terms "Lead-Free" or "Pb-Free" mean semiconductor products that are compatible with the current RoHS requirements for all 6 substances, including the requirement that lead not exceed 0.1% by weight in homogeneous materials. Where designed to be soldered at high temperatures, TI Pb-Free products are suitable for use in specified lead-free processes.

Pb-Free (RoHS Exempt): This component has a RoHS exemption for either 1) lead-based flip-chip solder bumps used between the die and package, or 2) lead-based die adhesive used between the die and leadframe. The component is otherwise considered Pb-Free (RoHS compatible) as defined above.

Green (RoHS & no Sb/Br): TI defines "Green" to mean Pb-Free (RoHS compatible), and free of Bromine (Br) and Antimony (Sb) based flame retardants (Br or Sb do not exceed 0.1% by weight in homogeneous material)

(3) MSL, Peak Temp. - The Moisture Sensitivity Level rating according to the JEDEC industry standard classifications, and peak solder temperature.

(4) There may be additional marking, which relates to the logo, the lot trace code information, or the environmental category on the device.

(5) Multiple Device Markings will be inside parentheses. Only one Device Marking contained in parentheses and separated by a "~" will appear on a device. If a line is indented then it is a continuation of the previous line and the two combined represent the entire Device Marking for that device.

(6) Lead/Ball Finish - Orderable Devices may have multiple material finish options. Finish options are separated by a vertical ruled line. Lead/Ball Finish values may wrap to two lines if the finish value exceeds the maximum column width.

Important Information and Disclaimer: The information provided on this page represents TI's knowledge and belief as of the date that it is provided. TI bases its knowledge and belief on information provided by third parties, and makes no representation or warranty as to the accuracy of such information. Efforts are underway to better integrate information from third parties. TI has taken and continues to take reasonable steps to provide representative and accurate information but may not have conducted destructive testing or chemical analysis on incoming materials and chemicals. TI and TI suppliers consider certain information to be proprietary, and thus CAS numbers and other limited information may not be available for release.

In no event shall TI's liability arising out of such information exceed the total purchase price of the TI part(s) at issue in this document sold by TI to Customer on an annual basis.

OTHER QUALIFIED VERSIONS OF LM22676, LM22676-Q1 :

- Catalog: [LM22676](#)
- Automotive: [LM22676-Q1](#)

NOTE: Qualified Version Definitions:

- Catalog - TI's standard catalog product
- Automotive - Q100 devices qualified for high-reliability automotive applications targeting zero defects

TAPE AND REEL INFORMATION



QUADRANT ASSIGNMENTS FOR PIN 1 ORIENTATION IN TAPE



*All dimensions are nominal

Device	Package Type	Package Drawing	Pins	SPQ	Reel Diameter (mm)	Reel Width W1 (mm)	A0 (mm)	B0 (mm)	K0 (mm)	P1 (mm)	W (mm)	Pin1 Quadrant
LM22676MRE-5.0/NOPB	SO Power PAD	DDA	8	250	178.0	12.4	6.5	5.4	2.0	8.0	12.0	Q1
LM22676MRE-ADJ/NOPB	SO Power PAD	DDA	8	250	178.0	12.4	6.5	5.4	2.0	8.0	12.0	Q1
LM22676MRX-5.0/NOPB	SO Power PAD	DDA	8	2500	330.0	12.4	6.5	5.4	2.0	8.0	12.0	Q1
LM22676MRX-ADJ/NOPB	SO Power PAD	DDA	8	2500	330.0	12.4	6.5	5.4	2.0	8.0	12.0	Q1
LM22676QMRE-5.0/NOPB	SO Power PAD	DDA	8	250	178.0	12.4	6.5	5.4	2.0	8.0	12.0	Q1
LM22676QMRE-ADJ/NOPB	SO Power PAD	DDA	8	250	178.0	12.4	6.5	5.4	2.0	8.0	12.0	Q1
LM22676QMRX-5.0/NOPB	SO Power PAD	DDA	8	2500	330.0	12.4	6.5	5.4	2.0	8.0	12.0	Q1
LM22676QMRX-ADJ/NOP	SO	DDA	8	2500	330.0	12.4	6.5	5.4	2.0	8.0	12.0	Q1

Device	Package Type	Package Drawing	Pins	SPQ	Reel Diameter (mm)	Reel Width W1 (mm)	A0 (mm)	B0 (mm)	K0 (mm)	P1 (mm)	W (mm)	Pin1 Quadrant
B	Power PAD											
LM22676QTJ-5.0/NOPB	TO-263	NDR	7	1000	330.0	24.4	10.6	15.4	2.45	12.0	24.0	Q2
LM22676QTJ-ADJ/NOPB	TO-263	NDR	7	1000	330.0	24.4	10.6	15.4	2.45	12.0	24.0	Q2
LM22676QTJE-5.0/NOPB	TO-263	NDR	7	250	178.0	24.4	10.6	15.4	2.45	12.0	24.0	Q2
LM22676QTJE-ADJ/NOPB	TO-263	NDR	7	250	178.0	24.4	10.6	15.4	2.45	12.0	24.0	Q2
LM22676TJ-5.0/NOPB	TO-263	NDR	7	1000	330.0	24.4	10.6	15.4	2.45	12.0	24.0	Q2
LM22676TJ-ADJ/NOPB	TO-263	NDR	7	1000	330.0	24.4	10.6	15.4	2.45	12.0	24.0	Q2
LM22676TJE-5.0/NOPB	TO-263	NDR	7	250	178.0	24.4	10.6	15.4	2.45	12.0	24.0	Q2
LM22676TJE-ADJ/NOPB	TO-263	NDR	7	250	178.0	24.4	10.6	15.4	2.45	12.0	24.0	Q2

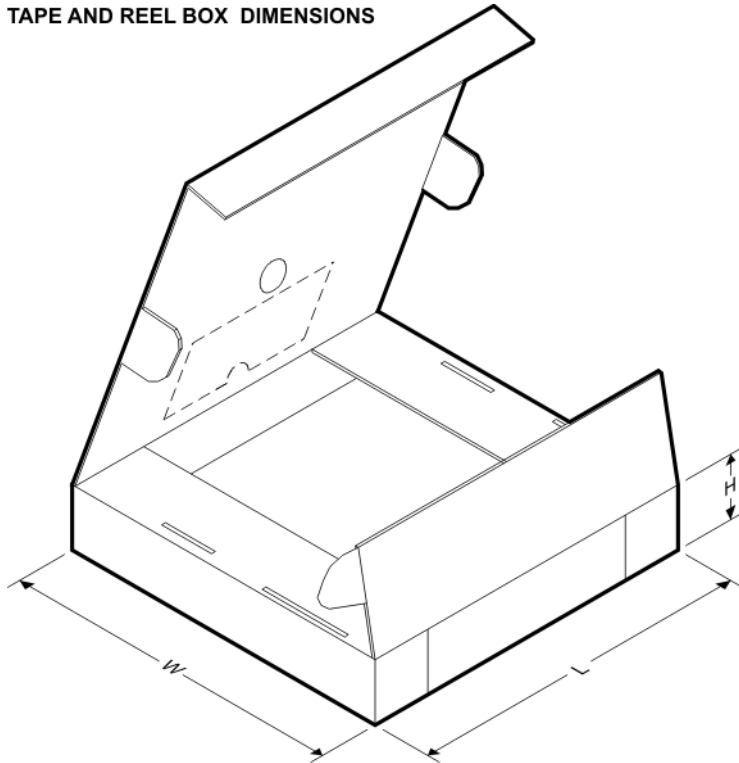
TAPE AND REEL BOX DIMENSIONS

*All dimensions are nominal

Device	Package Type	Package Drawing	Pins	SPQ	Length (mm)	Width (mm)	Height (mm)
LM22676MRE-5.0/NOPB	SO PowerPAD	DDA	8	250	210.0	185.0	35.0
LM22676MRE-ADJ/NOPB	SO PowerPAD	DDA	8	250	210.0	185.0	35.0
LM22676MRX-5.0/NOPB	SO PowerPAD	DDA	8	2500	367.0	367.0	35.0
LM22676MRX-ADJ/NOPB	SO PowerPAD	DDA	8	2500	367.0	367.0	35.0
LM22676QMRE-5.0/NOPB	SO PowerPAD	DDA	8	250	210.0	185.0	35.0
LM22676QMRE-ADJ/NOPB	SO PowerPAD	DDA	8	250	210.0	185.0	35.0

Device	Package Type	Package Drawing	Pins	SPQ	Length (mm)	Width (mm)	Height (mm)
LM22676QMRX-5.0/NOPB	SO PowerPAD	DDA	8	2500	367.0	367.0	35.0
LM22676QMRX-ADJ/NOPB	SO PowerPAD	DDA	8	2500	367.0	367.0	35.0
LM22676QTJ-5.0/NOPB	TO-263	NDR	7	1000	367.0	367.0	35.0
LM22676QTJ-ADJ/NOPB	TO-263	NDR	7	1000	367.0	367.0	35.0
LM22676QTJE-5.0/NOPB	TO-263	NDR	7	250	210.0	185.0	35.0
LM22676QTJE-ADJ/NOPB	TO-263	NDR	7	250	210.0	185.0	35.0
LM22676TJ-5.0/NOPB	TO-263	NDR	7	1000	367.0	367.0	35.0
LM22676TJ-ADJ/NOPB	TO-263	NDR	7	1000	367.0	367.0	35.0
LM22676TJE-5.0/NOPB	TO-263	NDR	7	250	210.0	185.0	35.0
LM22676TJE-ADJ/NOPB	TO-263	NDR	7	250	210.0	185.0	35.0



Images above are just a representation of the package family, actual package may vary.
Refer to the product data sheet for package details.

NDR0007A

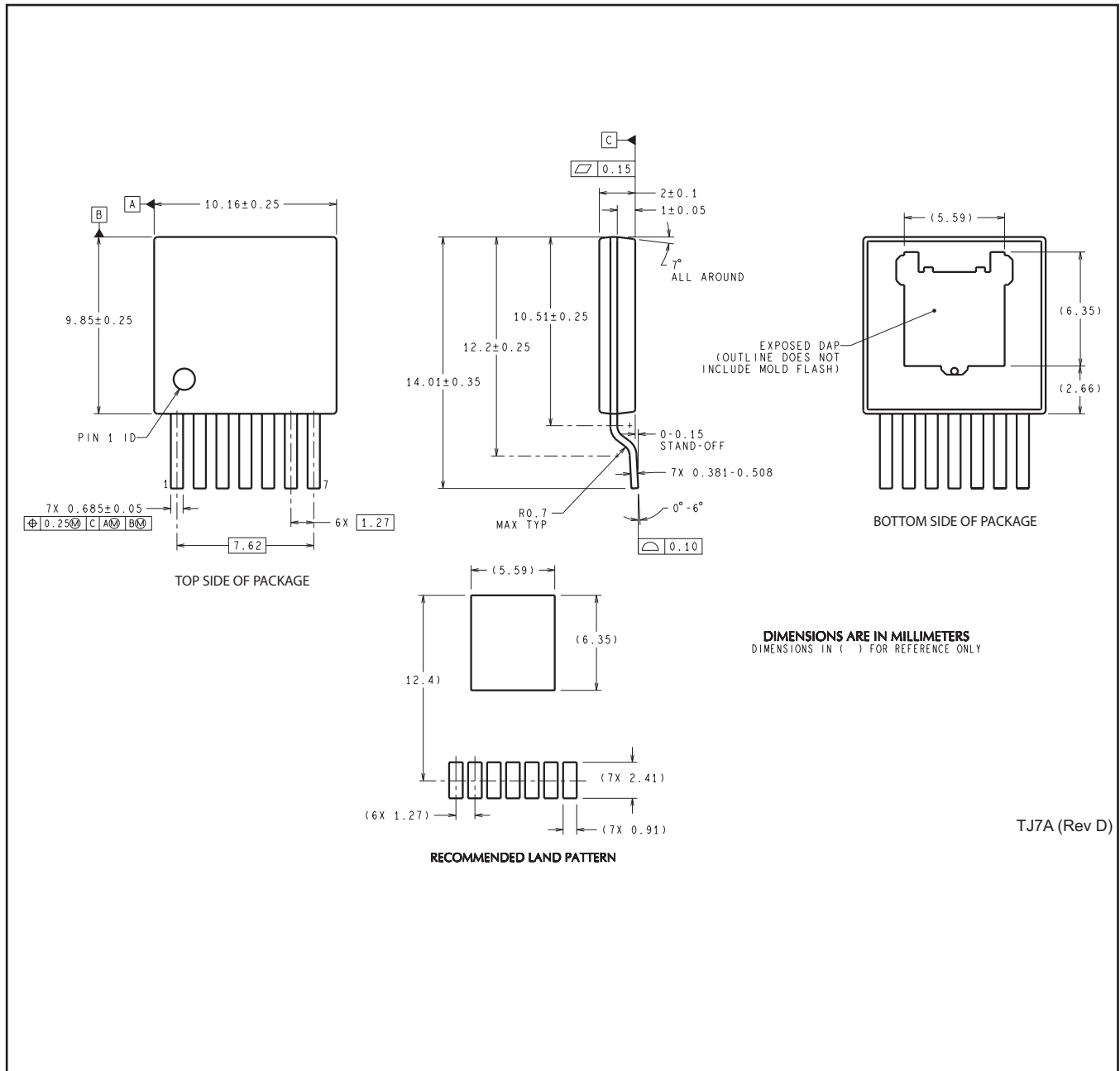

TJ7A (Rev D)

IMPORTANT NOTICE

Texas Instruments Incorporated (TI) reserves the right to make corrections, enhancements, improvements and other changes to its semiconductor products and services per JESD46, latest issue, and to discontinue any product or service per JESD48, latest issue. Buyers should obtain the latest relevant information before placing orders and should verify that such information is current and complete.

TI's published terms of sale for semiconductor products (<http://www.ti.com/sc/docs/stdterms.htm>) apply to the sale of packaged integrated circuit products that TI has qualified and released to market. Additional terms may apply to the use or sale of other types of TI products and services.

Reproduction of significant portions of TI information in TI data sheets is permissible only if reproduction is without alteration and is accompanied by all associated warranties, conditions, limitations, and notices. TI is not responsible or liable for such reproduced documentation. Information of third parties may be subject to additional restrictions. Resale of TI products or services with statements different from or beyond the parameters stated by TI for that product or service voids all express and any implied warranties for the associated TI product or service and is an unfair and deceptive business practice. TI is not responsible or liable for any such statements.

Buyers and others who are developing systems that incorporate TI products (collectively, "Designers") understand and agree that Designers remain responsible for using their independent analysis, evaluation and judgment in designing their applications and that Designers have full and exclusive responsibility to assure the safety of Designers' applications and compliance of their applications (and of all TI products used in or for Designers' applications) with all applicable regulations, laws and other applicable requirements. Designer represents that, with respect to their applications, Designer has all the necessary expertise to create and implement safeguards that (1) anticipate dangerous consequences of failures, (2) monitor failures and their consequences, and (3) lessen the likelihood of failures that might cause harm and take appropriate actions. Designer agrees that prior to using or distributing any applications that include TI products, Designer will thoroughly test such applications and the functionality of such TI products as used in such applications.

TI's provision of technical, application or other design advice, quality characterization, reliability data or other services or information, including, but not limited to, reference designs and materials relating to evaluation modules, (collectively, "TI Resources") are intended to assist designers who are developing applications that incorporate TI products; by downloading, accessing or using TI Resources in any way, Designer (individually or, if Designer is acting on behalf of a company, Designer's company) agrees to use any particular TI Resource solely for this purpose and subject to the terms of this Notice.

TI's provision of TI Resources does not expand or otherwise alter TI's applicable published warranties or warranty disclaimers for TI products, and no additional obligations or liabilities arise from TI providing such TI Resources. TI reserves the right to make corrections, enhancements, improvements and other changes to its TI Resources. TI has not conducted any testing other than that specifically described in the published documentation for a particular TI Resource.

Designer is authorized to use, copy and modify any individual TI Resource only in connection with the development of applications that include the TI product(s) identified in such TI Resource. NO OTHER LICENSE, EXPRESS OR IMPLIED, BY ESTOPPEL OR OTHERWISE TO ANY OTHER TI INTELLECTUAL PROPERTY RIGHT, AND NO LICENSE TO ANY TECHNOLOGY OR INTELLECTUAL PROPERTY RIGHT OF TI OR ANY THIRD PARTY IS GRANTED HEREIN, including but not limited to any patent right, copyright, mask work right, or other intellectual property right relating to any combination, machine, or process in which TI products or services are used. Information regarding or referencing third-party products or services does not constitute a license to use such products or services, or a warranty or endorsement thereof. Use of TI Resources may require a license from a third party under the patents or other intellectual property of the third party, or a license from TI under the patents or other intellectual property of TI.

TI RESOURCES ARE PROVIDED "AS IS" AND WITH ALL FAULTS. TI DISCLAIMS ALL OTHER WARRANTIES OR REPRESENTATIONS, EXPRESS OR IMPLIED, REGARDING RESOURCES OR USE THEREOF, INCLUDING BUT NOT LIMITED TO ACCURACY OR COMPLETENESS, TITLE, ANY EPIDEMIC FAILURE WARRANTY AND ANY IMPLIED WARRANTIES OF MERCHANTABILITY, FITNESS FOR A PARTICULAR PURPOSE, AND NON-INFRINGEMENT OF ANY THIRD PARTY INTELLECTUAL PROPERTY RIGHTS. TI SHALL NOT BE LIABLE FOR AND SHALL NOT DEFEND OR INDEMNIFY DESIGNER AGAINST ANY CLAIM, INCLUDING BUT NOT LIMITED TO ANY INFRINGEMENT CLAIM THAT RELATES TO OR IS BASED ON ANY COMBINATION OF PRODUCTS EVEN IF DESCRIBED IN TI RESOURCES OR OTHERWISE. IN NO EVENT SHALL TI BE LIABLE FOR ANY ACTUAL, DIRECT, SPECIAL, COLLATERAL, INDIRECT, PUNITIVE, INCIDENTAL, CONSEQUENTIAL OR EXEMPLARY DAMAGES IN CONNECTION WITH OR ARISING OUT OF TI RESOURCES OR USE THEREOF, AND REGARDLESS OF WHETHER TI HAS BEEN ADVISED OF THE POSSIBILITY OF SUCH DAMAGES.

Unless TI has explicitly designated an individual product as meeting the requirements of a particular industry standard (e.g., ISO/TS 16949 and ISO 26262), TI is not responsible for any failure to meet such industry standard requirements.

Where TI specifically promotes products as facilitating functional safety or as compliant with industry functional safety standards, such products are intended to help enable customers to design and create their own applications that meet applicable functional safety standards and requirements. Using products in an application does not by itself establish any safety features in the application. Designers must ensure compliance with safety-related requirements and standards applicable to their applications. Designer may not use any TI products in life-critical medical equipment unless authorized officers of the parties have executed a special contract specifically governing such use. Life-critical medical equipment is medical equipment where failure of such equipment would cause serious bodily injury or death (e.g., life support, pacemakers, defibrillators, heart pumps, neurostimulators, and implantables). Such equipment includes, without limitation, all medical devices identified by the U.S. Food and Drug Administration as Class III devices and equivalent classifications outside the U.S.

TI may expressly designate certain products as completing a particular qualification (e.g., Q100, Military Grade, or Enhanced Product). Designers agree that it has the necessary expertise to select the product with the appropriate qualification designation for their applications and that proper product selection is at Designers' own risk. Designers are solely responsible for compliance with all legal and regulatory requirements in connection with such selection.

Designer will fully indemnify TI and its representatives against any damages, costs, losses, and/or liabilities arising out of Designer's non-compliance with the terms and provisions of this Notice.