

FEATURES

- RoHS compliant
- Basic/supplementary isolation to UL 60950²
- ANSI/AAMI ES60601-1
- Power density 0.81W/cm³
- Single and dual outputs
- UL 94V-0 package material
- Footprint 1.96cm²
- SIP package style
- 5.2kVDC isolation 'Hi Pot Test'
- 3.3V, 5V, 12V & 15V inputs
- 3.3V, 5V, 9V, 12V & 15V output
- Internal SMD construction
- Fully encapsulated with toroidal magnetics
- Pin compatible with the MEV, NMV, NMK, & NMJ series
- MTTF up to 4.2 million hours

PRODUCT OVERVIEW

The MEJ2 series are single and dual output medically approved DC/DC converters in a 7 pin SIP package style offering a power upgrade path from the NMJ series SIP DC/DC converters. The MEJ2 series is UL 60950 and ANSI/AAMI ES60601-1 recognized, which makes it ideal for applications where safety and miniaturisation are of paramount importance.

SELECTION GUIDE

Order Code	Nominal Input Voltage	Output Voltage	Output Current	Input Current at Rated Load	Load Regulation (Typ)	Load Regulation (Max)	Ripple & Noise (Typ) ³	Ripple & Noise (Max) ³	Efficiency (Min)	Efficiency (Typ)	MTTF ²
	V	V	mA		%		mVp-p		%		kHrs
MEJ2S0303SC	3.3	3.3	606	756	14.0	17	38	55	67	70	3910
MEJ2S0305SC	3.3	5	400	784	13.0	15	50	65	70	74	3757
MEJ2S0503SC	5	3.3	606	528	10.0	15	40	55	67	70	3830
MEJ2S0505SC	5	5	400	503	8.5	10	43	55	72	75	3654
MEJ2S0509SC	5	9	222	505	8.0	11	36	50	75	78	3472
MEJ2S0512SC	5	12	167	495	8.0	12	40	55	74	77	3663
MEJ2S0515SC	5	15	133	488	7.0	10	34	45	76	79	2629
MEJ2S1203SC	12	3.3	606	207	9.5	11	43	60	70	73	3259
MEJ2S1205SC	12	5	400	214	8.0	10	43	60	75	78	3200
MEJ2S1209SC	12	9	222	205	7.0	10	35	50	75	79	2453
MEJ2S1212SC	12	12	167	207	6.5	8	35	50	76	80	2779
MEJ2S1215SC	12	15	133	205	7.0	10	32	45	76	80	2707
MEJ2S1505SC	15	5	400	171	8.5	10	44	60	73	76	2638
MEJ2S1509SC	15	9	222	165	6.5	8	35	50	74	78	2203
MEJ2S1512SC	15	12	167	164	6.5	8	38	55	74	79	2330
MEJ2S1515SC	15	15	133	166	7.0	8	36	50	74	78	2100
MEJ2D0503SC	5	±3.3	±303	535	8.5	10	26	40	67	71	3969
MEJ2D0505SC	5	±5	±200	508	7.5	9	34	50	72	76	3654
MEJ2D0509SC	5	±9	±111	510	6.5	8	27	40	76	79	3472
MEJ2D0512SC	5	±12	±83	504	5.0	8	27	40	77	80	3663
MEJ2D0515SC	5	±15	±67	492	6.5	7	20	35	76	79	2629
MEJ2D1203SC	12	±3.3	±303	205	8.0	9	37	55	72	75	3270
MEJ2D1205SC	12	±5	±200	212	7.0	8	32	45	75	79	3268
MEJ2D1209SC	12	±9	±111	206	5.5	7	27	40	77	81	2453
MEJ2D1212SC	12	±12	±83	208	5.5	7	27	40	77	81	2779
MEJ2D1215SC	12	±15	±67	203	6.0	7	24	40	78	82	2707
MEJ2D1505SC	15	±5	±200	170	7.0	9	37	50	74	78	2638
MEJ2D1509SC	15	±9	±111	163	5.5	7	26	40	76	80	2203
MEJ2D1512SC	15	±12	±83	167	5.5	7	26	40	75	80	2330
MEJ2D1515SC	15	±15	±67	167	5.5	7	23	35	75	79	2100

INPUT CHARACTERISTICS

Parameter	Conditions	Min.	Typ.	Max.	Units
Voltage range	Continuous operation, 3V input types	2.97	3.3	3.63	V
	Continuous operation, 5V input types	4.5	5	5.5	
	Continuous operation, 12V input types	10.8	12	13.2	
	Continuous operation, 15V input types	13.5	15	16.5	
Input reflected ripple	3.3V input types		100	140	mA
	5V input types		60	90	
	12V & 15V input types		22	40	

1. Calculated using MIL-HDBK-217 FN2 calculation model with nominal input voltage at full load.
 2. See safety approvals section for limitations of use.
 3. See ripple & noise test method.
 All specifications typical at T_A=25°C, nominal input voltage and rated output current unless otherwise specified.



OUTPUT CHARACTERISTICS

Parameter	Conditions	Min.	Typ.	Max.	Units
Rated Power ²	T _A =-40°C to 85°C			2	W
Voltage Set Point Accuracy	See tolerance envelopes				
Line regulation	High V _{IN} to low V _{IN}		1.0	1.2	%/%

ABSOLUTE MAXIMUM RATINGS

Short-circuit protection	10 minutes
Lead temperature 1mm from case for 10 seconds	260°C
Input voltage V _{IN} , MEJ2x03xxSC	5V
Input voltage V _{IN} , MEJ2x05xxSC	7V
Input voltage V _{IN} , MEJ2x12xxSC	15V
Input voltage V _{IN} , MEJ2x15xxSC	18V

ISOLATION CHARACTERISTICS

Parameter	Conditions	Min.	Typ.	Max.	Units
Isolation test voltage	Flash tested for 1 second	5200			VDC
Resistance	Viso= 500VDC		1		GΩ
Isolation capacitance			4		pF

GENERAL CHARACTERISTICS

Parameter	Conditions	Min.	Typ.	Max.	Units
Switching frequency	All types		45		kHz

TEMPERATURE CHARACTERISTICS

Parameter	Conditions	Min.	Typ.	Max.	Units
Specification	All output types (see safety approval section for limitations)	-40		85	°C
Storage		-55		125	
Case Temperature above ambient	MEJ2S0509SC, MEJ2S0512SC, MEJ2S0515SC, MEJ2S1209SC, MEJ2x1212SC, MEJ2S1215SC, MEJ2S1509SC, MEJ2S1512SC, MEJ2S1515SC		27		
	MEJ2S0503SC, MEJ2S0505SC, MEJ2S1203SC, MEJ2S1205SC, MEJ2x1505SC, MEJ2S1515SC, MEJ2D0512SC, MEJ2D0515SC, MEJ2D1209SC, MEJ2D1215SC		30		
	MEJ2S0305SC, MEJ2S0303SC, MEJ2S1203SC, MEJ2D0505SC, MEJ2D0509SC, MEJ2D1205SC, MEJ2D1509SC, MEJ2D1512SC		33		
	MEJ2D01203SC, MEJ2D0503SC		37		
Cooling	Free air convection				

TEMPERATURE DERATING GRAPH

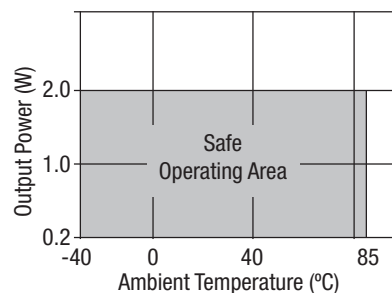

UL60950 recognition to a maximum ambient temperature of 85°C and/or case temperature limit of 155°C, measured on the face opposite the pins.

TOLERANCE ENVELOPE

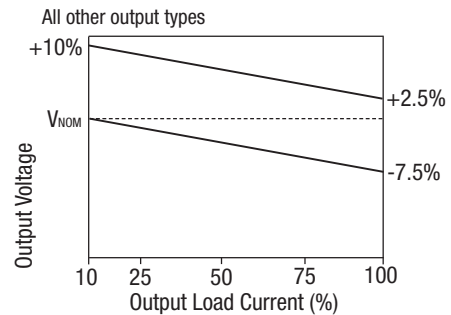
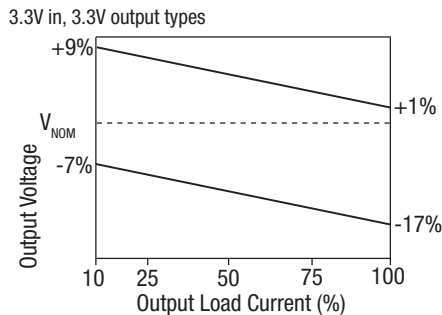

The voltage tolerance envelope shows typical load regulation characteristics for this product series. The tolerance envelope is the maximum output voltage variation due to changes in output loading.

TECHNICAL NOTES

ISOLATION VOLTAGE

'Hi Pot Test', 'Flash Tested', 'Withstand Voltage', 'Proof Voltage', 'Dielectric Withstand Voltage' & 'Isolation Test Voltage' are all terms that relate to the same thing, a test voltage, applied for a specified time, across a component designed to provide electrical isolation, to verify the integrity of that isolation.

Murata Power Solutions MEJ2 series of DC/DC converters are all 100% production tested at their stated isolation voltage. This is 5.2kVDC for 1 second.

A question commonly asked is, "What is the continuous voltage that can be applied across the part in normal operation?"

The MEJ2 series has been recognized by Underwriters Laboratory for various voltages, please see safety approval section below.

REPEATED HIGH-VOLTAGE ISOLATION TESTING

It is well known that repeated high-voltage isolation testing of a barrier component can actually degrade isolation capability, to a lesser or greater degree depending on materials, construction and environment. We therefore strongly advise against repeated high voltage isolation testing, but if it is absolutely required, that the voltage be reduced by 20% from specified test voltage.

SAFETY APPROVAL

ANSI/AAMI ES60601-1

The MEJ2 series has been tested by Underwriters Laboratory (UL) to meet ANSI/AAMI ES60601-1 medical safety standard providing the following MOOP (means of operator protection), in a maximum ambient temperature of 85°C and/or case temperature limit of 130°C (case temperature measured on the face opposite the pins): 1 MOOP based upon a working voltage of 200 Vrms max and 280 Vpk max., between Primary and Secondary and between Primary and its Enclosure. File Number E202895 applies.

UL 60950

The MEJ2 series has been recognized by Underwriters Laboratory (UL) to UL 60950 for basic/supplementary insulation to a working voltage of 250Vrms in a maximum ambient temperature of 85°C and/or case temperature limit of 130°C (case temperature measured on the face opposite the pins). File number E151252 applies.

FUSING

The MEJ2 Series of converters are not internally fused so to meet the requirements of UL an anti-surge input line fuse should always be used with ratings as defined below.

- MEJ2x03xxxC: 2A
- MEJ2x05xxxC: 2A
- MEJ2x12xxxC: 750mA
- MEJ2x15xxxC: 750mA

All fuses should be UL recognized and rated to at least the maximum allowable DC input voltage.

RoHS COMPLIANCE INFORMATION



This series is compatible with RoHS soldering systems with a peak wave solder temperature of 260°C for 10 seconds. The pin termination finish on this product series is Tin Plate, Hot Dipped over Matte Tin with Nickel Preplate. The series is backward compatible with Sn/Pb soldering systems. For further information, please visit www.murata-ps.com/rohs

APPLICATION NOTES

Minimum load

The minimum load to meet datasheet specification is 10% of the full rated load across the specified input voltage range. Lower than 10% minimum loading will result in an increase in output voltage, which may rise to typically double the specified output voltage if the output load falls to less than 5%.

Capacitive loading and start up

Typical start up times for this series, with a typical input voltage rise time of 2.2µs and output capacitance of 10µF, are shown in the table below. The product series will start into a capacitance of 47µF with an increased start time, however, the maximum recommended output capacitance is 10µF.

	Start-up time ms		Start-up time ms
MEJ2S0303SC	0.89	MEJ2S1515SC	6.05
MEJ2S0305SC	1.89	MEJ2D0503SC	1.57
MEJ2S0503SC	1.08	MEJ2D0505SC	1.79
MEJ2S0505SC	2.04	MEJ2D0509SC	9.32
MEJ2S0509SC	6.5	MEJ2D0512SC	14.9
MEJ2S0512SC	8.29	MEJ2D0515SC	20.84
MEJ2S0515SC	11.4	MEJ2D1203SC	1.03
MEJ2S1203SC	0.73	MEJ2D1205SC	2.51
MEJ2S1205SC	1.61	MEJ2D1209SC	6.46
MEJ2S1209SC	4.04	MEJ2D1212SC	9.94
MEJ2S1212SC	5.51	MEJ2D1215SC	14.54
MEJ2S1215SC	7.61	MEJ2D1505SC	1.79
MEJ2S1505SC	1.33	MEJ2D1509SC	5.16
MEJ2S1509SC	3.37	MEJ2D1512SC	7.04
MEJ2S1512SC	4.47	MEJ2D1515SC	10.48

Typical Start-Up Wave Form

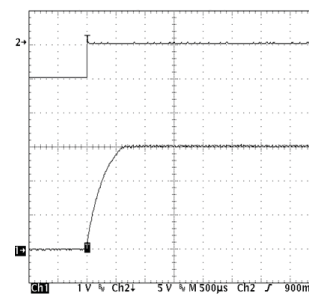

Ripple & Noise Characterisation Method

Ripple and noise measurements are performed with the following test configuration.

C1	1µF X7R multilayer ceramic capacitor, voltage rating to be a minimum of 3 times the output voltage of the DC/DC converter
C2	10µF tantalum capacitor, voltage rating to be a minimum of 1.5 times the output voltage of the DC/DC converter with an ESR of less than 100mΩ at 100 kHz
C3	100nF multilayer ceramic capacitor, general purpose
R1	450Ω resistor, carbon film, ±1% tolerance
R2	50Ω BNC termination
T1	3T of the coax cable through a ferrite toroid
RLOAD	Resistive load to the maximum power rating of the DC/DC converter. Connections should be made via twisted wires

Measured values are multiplied by 10 to obtain the specified values.

Differential Mode Noise Test Schematic

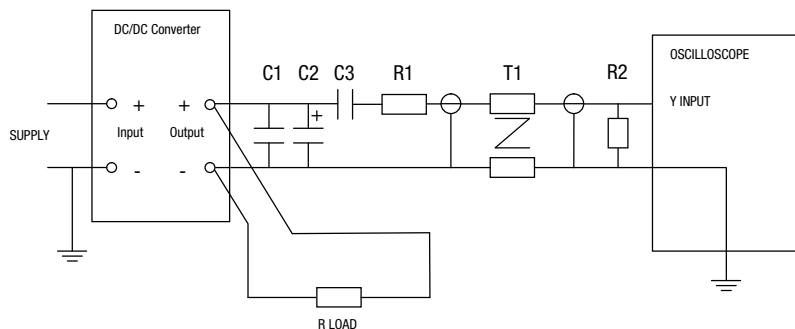

EFFICIENCY VS LOAD

MEJ2S03XXSC

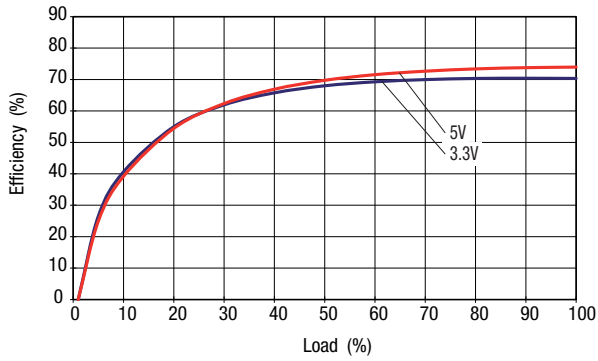

MEJ2S05XXSC

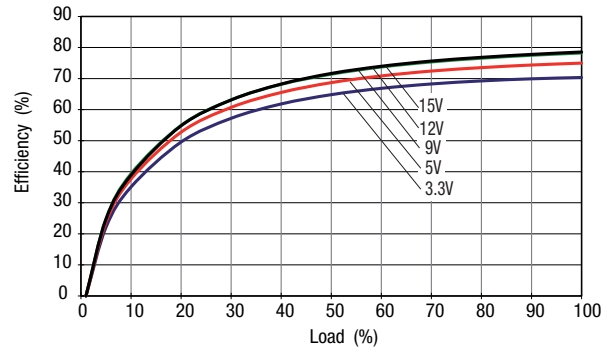

MEJ2S12XXSC

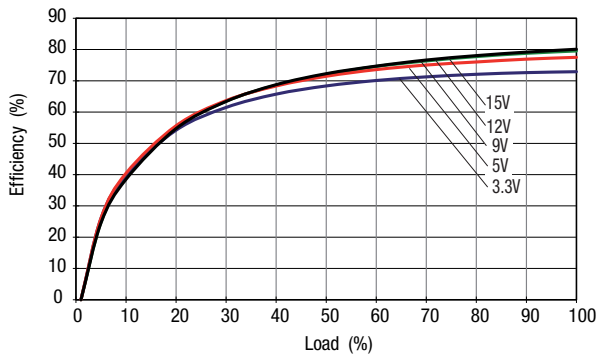

MEJ2S15XXSC

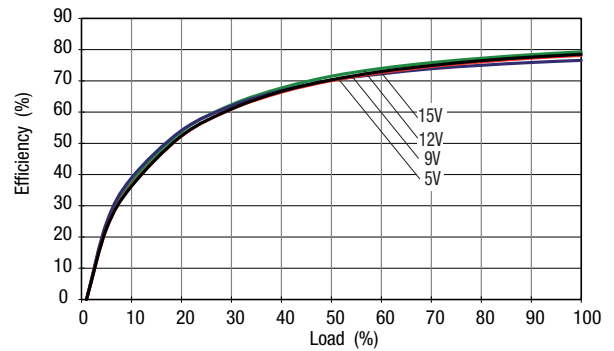

EFFICIENCY VS LOAD

MEJ2D05XXSC

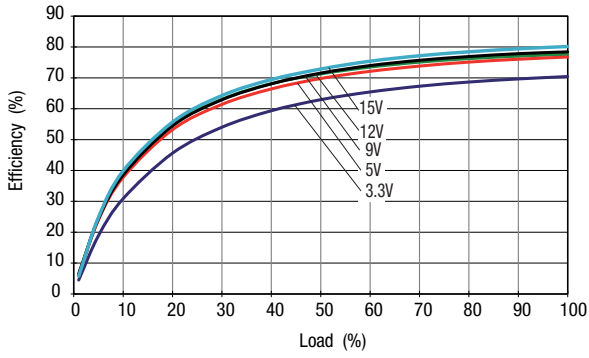

MEJ2D12XXSC

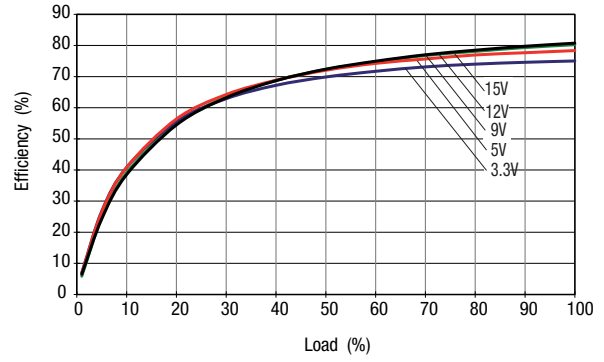

MEJ2D15XXSC

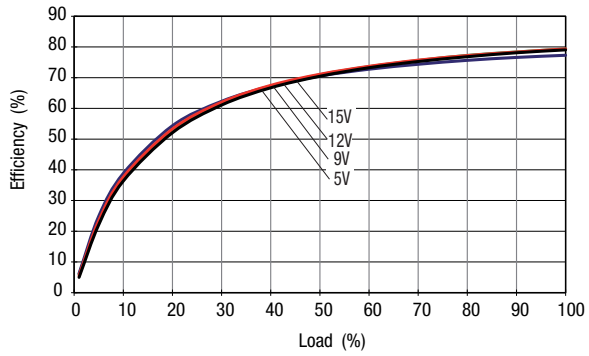

PACKAGE SPECIFICATIONS

MECHANICAL DIMENSIONS

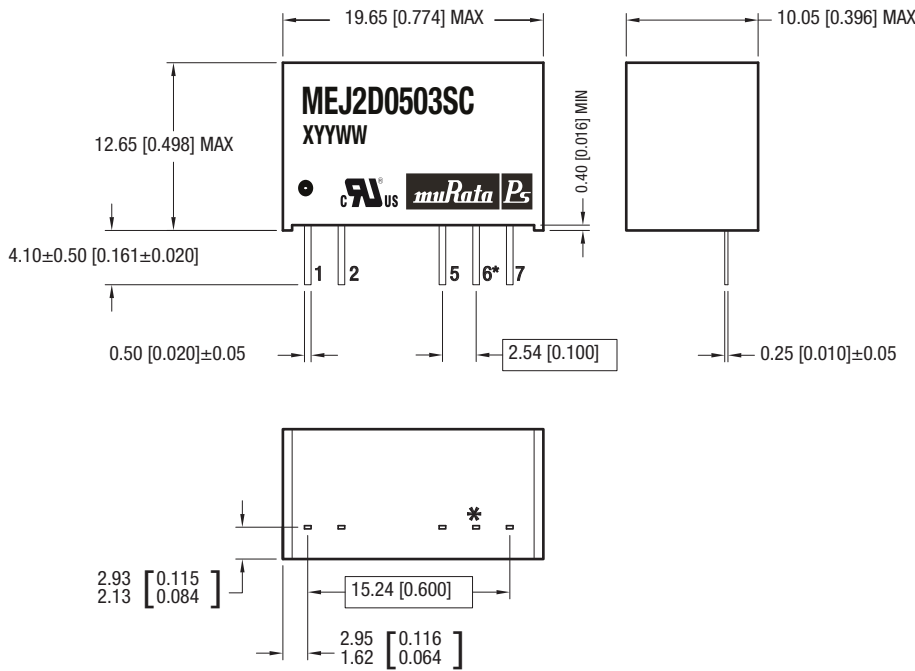

All dimensions in mm ± 0.25 mm (inches ± 0.01). All pins on a 2.54 (0.1) pitch and within ± 0.25 (0.01) of true position.
* Pin not fitted on single output variants.

Weight: 4.3g

PIN CONNECTIONS

Single Output

Pin	Function
1	+Vin
2	-Vin
5	-Vout
7	+Vout

Dual Output

Pin	Function
1	+VIN
2	-VIN
5	-VOUT
6*	OV
7	+VOUT

TUBE OUTLINE DIMENSIONS

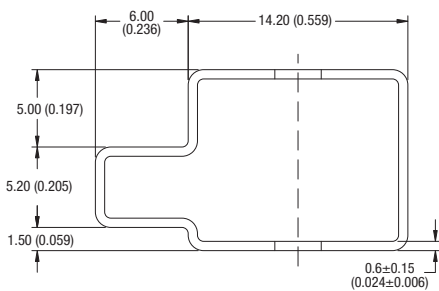

Unless otherwise stated all dimensions in mm ± 0.5 mm (inches ± 0.02).
Tube length : 20.669 \pm 0.079 (525mm \pm 2mm).

Tube Quantity : 25

RECOMMENDED FOOTPRINT DETAILS

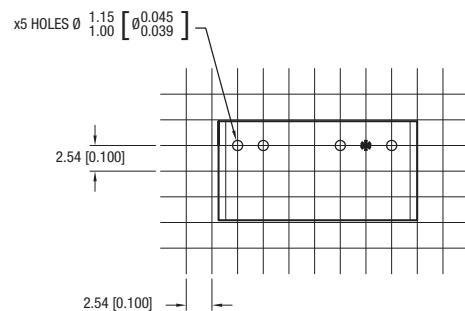

* Hole not required for single output variants.
All dimensions in mm ± 0.25 mm (inches ± 0.01).

Murata Power Solutions, Inc.
11 Cabot Boulevard, Mansfield, MA 02048-1151 U.S.A.
ISO 9001 and 14001 REGISTERED



This product is subject to the following **operating requirements** and the **Life and Safety Critical Application Sales Policy**:
Refer to: <http://www.murata-ps.com/requirements/>

Murata Power Solutions, Inc. makes no representation that the use of its products in the circuits described herein, or the use of other technical information contained herein, will not infringe upon existing or future patent rights. The descriptions contained herein do not imply the granting of licenses to make, use, or sell equipment constructed in accordance therewith. Specifications are subject to change without notice.
© 2017 Murata Power Solutions, Inc.