

MC74LCX16373

Low-Voltage CMOS 16-Bit Transparent Latch

With 5 V-Tolerant Inputs and Outputs (3-State, Non-Inverting)

The MC74LCX16373 is a high performance, non-inverting 16-bit transparent latch operating from a 2.3 V to 3.6 V supply. The device is byte controlled. Each byte has separate Output Enable and Latch Enable inputs. These control pins can be tied together for full 16-bit operation. High impedance TTL compatible inputs significantly reduce current loading to input drivers while TTL compatible outputs offer improved switching noise performance. A V_I specification of 5.5 V allows MC74LCX16373 inputs to be safely driven from 5.0 V devices.

The MC74LCX16373 contains 16 D-type latches with 3-state 5.0 V-tolerant outputs. When the Latch Enable (LEn) inputs are HIGH, data on the Dn inputs enters the latches. In this condition, the latches are transparent, i.e., a latch output will change state each time its D input changes. When LE is LOW, the latches store the information that was present on the D inputs a setup time preceding the HIGH-to-LOW transition of LE. The 3-state outputs are controlled by the Output Enable ($\overline{OE}n$) inputs. When \overline{OE} is LOW, the outputs are enabled. When \overline{OE} is HIGH, the standard outputs are in the high impedance state, but this does not interfere with new data entering into the latches.

Features

- Designed for 2.3 to 3.6 V V_{CC} Operation
- 5.4 ns Maximum t_{pd}
- 5.0 V Tolerant – Interface Capability With 5.0 V TTL Logic
- Supports Live Insertion and Withdrawal
- I_{OFF} Specification Guarantees High Impedance When $V_{CC} = 0$ V
- LVTTL Compatible
- LVCMOS Compatible
- 24 mA Balanced Output Sink and Source Capability
- Near Zero Static Supply Current in All Three Logic States (20 μ A) Substantially Reduces System Power Requirements
- Latchup Performance Exceeds 500 mA
- ESD Performance:
 - ◆ Human Body Model >2000 V
 - ◆ Machine Model >200 V
- These Devices are Pb-Free, Halogen Free/BFR Free and are RoHS Compliant



ON Semiconductor®

<http://onsemi.com>

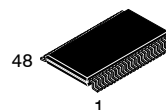

TSSOP-48
DT SUFFIX
CASE 1201

MARKING DIAGRAM

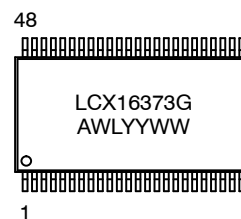

A = Assembly Location
WL = Wafer Lot
YY = Year
WW = Work Week
G = Pb-Free Package

ORDERING INFORMATION

See detailed ordering and shipping information in the package dimensions section on page 3 of this data sheet.

MC74LCX16373

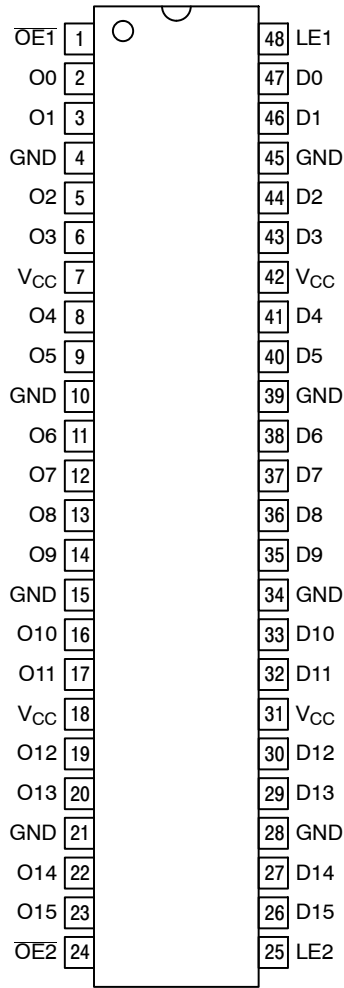

Figure 1. Pinout: 48-Lead
(Top View)

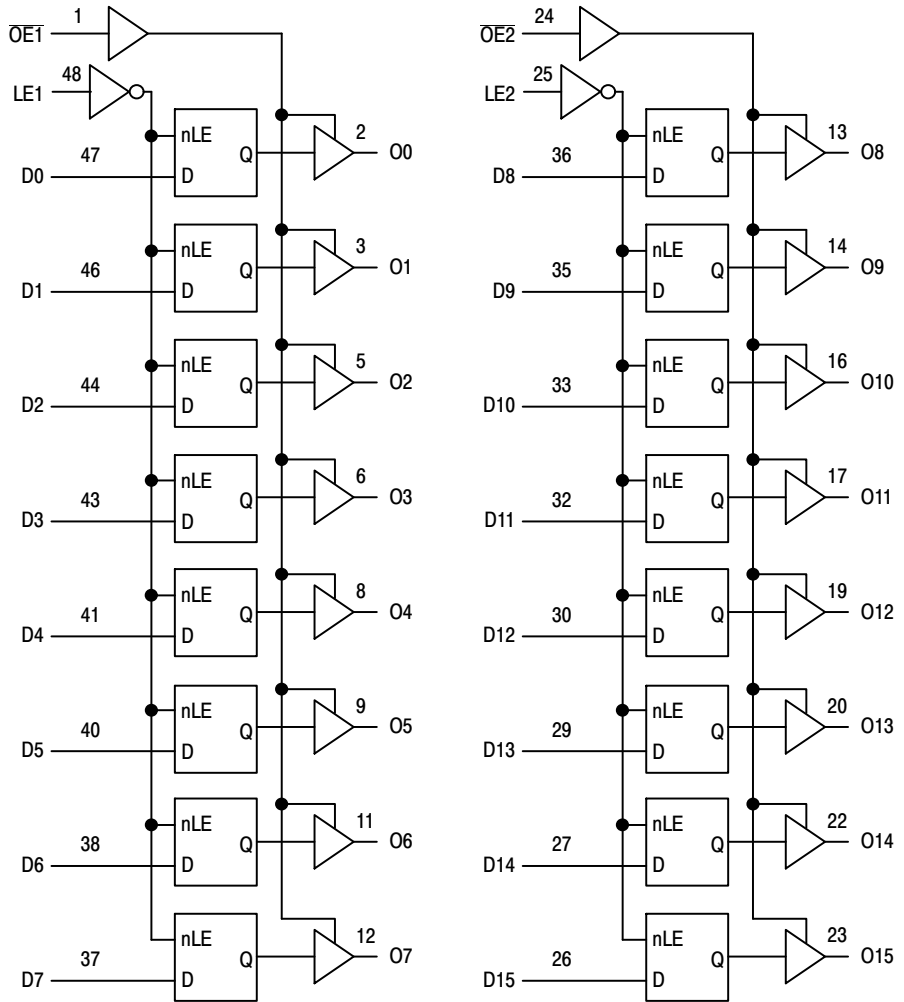

Figure 2. Logic Diagram

Table 1. PIN NAMES

Pins	Function
$\overline{OE}n$	Output Enable Inputs
LEn	Latch Enable Inputs
D0-D15	Inputs
O0-O15	Outputs

TRUTH TABLE

Inputs			Outputs	Inputs			Outputs
LE1	$\overline{OE}1$	D0:7	O0:7	LE2	$\overline{OE}2$	D8:15	O8:15
X	H	X	Z	X	H	X	Z
H	L	L	L	H	L	L	L
H	L	H	H	H	L	H	H
L	L	X	O0	L	L	X	O0

H = High Voltage Level

L = Low Voltage Level

Z = High Impedance State

X = High or Low Voltage Level and Transitions Are Acceptable; for I_{CC} reasons, DO NOT FLOAT Inputs

MC74LCX16373

ORDERING INFORMATION

Device	Package	Shipping†
MC74LCX16373DTRG	TSSOP-48 (Pb-Free)	39 Units / Rail
M74LCX16373DTR2G	TSSOP-48 (Pb-Free)	2500 / Tape & Reel

†For information on tape and reel specifications, including part orientation and tape sizes, please refer to our Tape and Reel Packaging Specifications Brochure, BRD8011/D.

MAXIMUM RATINGS

Symbol	Parameter	Value	Condition	Units
V_{CC}	DC Supply Voltage	-0.5 to +7.0		V
V_I	DC Input Voltage	$-0.5 \leq V_I \leq +7.0$		V
V_O	DC Output Voltage	$-0.5 \leq V_O \leq +7.0$	Output in 3-State	V
		$-0.5 \leq V_O \leq V_{CC} + 0.5$	Output in HIGH or LOW State. (Note 1)	V
I_{IK}	DC Input Diode Current	-50	$V_I < \text{GND}$	mA
I_{OK}	DC Output Diode Current	-50	$V_O < \text{GND}$	mA
		+50	$V_O > V_{CC}$	mA
I_O	DC Output Source/Sink Current	± 50		mA
I_{CC}	DC Supply Current Per Supply Pin	± 100		mA
I_{GND}	DC Ground Current Per Ground Pin	± 100		mA
T_{STG}	Storage Temperature Range	-65 to +150		°C
MSL	Moisture Sensitivity		Level 1	

Stresses exceeding Maximum Ratings may damage the device. Maximum Ratings are stress ratings only. Functional operation above the Recommended Operating Conditions is not implied. Extended exposure to stresses above the Recommended Operating Conditions may affect device reliability.

1. I_O absolute maximum rating must be observed.

RECOMMENDED OPERATING CONDITIONS

Symbol	Parameter	Min	Typ	Max	Units
V_{CC}	Supply Voltage Operating Data Retention Only	2.0	2.5, 3.3	3.6	V
		1.5	2.5, 3.3	3.6	
V_I	Input Voltage	0		5.5	V
V_O	Output Voltage (HIGH or LOW State) (3-State)	0		V_{CC}	V
		0		5.5	
I_{OH}	HIGH Level Output Current $V_{CC} = 3.0 \text{ V} - 3.6 \text{ V}$ $V_{CC} = 2.7 \text{ V} - 3.0 \text{ V}$ $V_{CC} = 2.3 \text{ V} - 2.7 \text{ V}$			-24	mA
				-12	
				-8	
I_{OL}	LOW Level Output Current $V_{CC} = 3.0 \text{ V} - 3.6 \text{ V}$ $V_{CC} = 2.7 \text{ V} - 3.0 \text{ V}$ $V_{CC} = 2.3 \text{ V} - 2.7 \text{ V}$			+24	mA
				+12	
				+8	
T_A	Operating Free-Air Temperature	-55		+125	°C
$\Delta t/\Delta V$	Input Transition Rise or Fall Rate, V_{IN} from 0.8 V to 2.0 V, $V_{CC} = 3.0 \text{ V}$	0		10	ns/V

MC74LCX16373

DC ELECTRICAL CHARACTERISTICS

Symbol	Characteristic	Condition	T _A = -55°C to +125°C		Units
			Min	Max	
V _{IH}	HIGH Level Input Voltage (Note 2)	2.3 V ≤ V _{CC} ≤ 2.7 V	1.7		V
		2.7 V ≤ V _{CC} ≤ 3.6 V	2.0		
V _{IL}	LOW Level Input Voltage (Note 2)	2.3 V ≤ V _{CC} ≤ 2.7 V		0.7	V
		2.7 V ≤ V _{CC} ≤ 3.6 V		0.8	
V _{OH}	HIGH Level Output Voltage	2.3 V ≤ V _{CC} ≤ 3.6 V; I _{OL} = 100 μA	V _{CC} - 0.2		V
		V _{CC} = 2.3 V; I _{OH} = -8 mA	1.8		
		V _{CC} = 2.7 V; I _{OH} = -12 mA	2.2		
		V _{CC} = 3.0 V; I _{OH} = -18 mA	2.4		
		V _{CC} = 3.0 V; I _{OH} = -24 mA	2.2		
V _{OL}	LOW Level Output Voltage	2.3 V ≤ V _{CC} ≤ 3.6 V; I _{OL} = 100 μA		0.2	V
		V _{CC} = 2.3 V; I _{OL} = 8 mA		0.6	
		V _{CC} = 2.7 V; I _{OL} = 12 mA		0.4	
		V _{CC} = 3.0 V; I _{OL} = 16 mA		0.4	
		V _{CC} = 3.0 V; I _{OL} = 24 mA		0.55	
I _{OZ}	3-State Output Current	V _{CC} = 3.6 V, V _{IN} = V _{IH} or V _{IL} , V _{OUT} = 0 to 5.5 V		±5	μA
I _{OFF}	Power Off Leakage Current	V _{CC} = 0, V _{IN} = 5.5 V or V _{OUT} = 5.5 V		10	μA
I _{IN}	Input Leakage Current	V _{CC} = 3.6 V, V _{IN} = 5.5 V or GND		±5	μA
I _{CC}	Quiescent Supply Current	V _{CC} = 3.6 V, V _{IN} = 5.5 V or GND		20	μA
ΔI _{CC}	Increase in I _{CC} per Input	2.3 ≤ V _{CC} ≤ 3.6 V; V _{IH} = V _{CC} - 0.6 V		500	μA

2. These values of V_I are used to test DC electrical characteristics only.

AC CHARACTERISTICS (t_R = t_F = 2.5 ns; C_L = 50 pF; R_L = 500 Ω)

Symbol	Parameter	Waveform	T _A = -55°C to +125°C						Units
			V _{CC} = 3.3 V ± 0.3 V C _L = 50 pF		V _{CC} = 2.7 V C _L = 50 pF		V _{CC} = 2.5 V ± 0.2 V C _L = 30 pF		
			Min	Max	Min	Max	Min	Max	
t _{PLH} t _{PHL}	Propagation Delay D _n to O _n	1	1.5	5.4	1.5	5.9	1.5	6.5	ns
			1.5	5.4	1.5	5.9	1.5	6.5	
t _{PLH} t _{PHL}	Propagation Delay LE to O _n	3	1.5	5.5	1.5	6.4	1.5	6.6	ns
			1.5	5.5	1.5	6.4	1.5	6.6	
t _{PZH} t _{PZL}	Output Enable Time to High and Low Level	2	1.5	6.1	1.5	6.5	1.5	7.9	ns
			1.5	6.1	1.5	6.5	1.5	7.9	
t _{PHZ} t _{PLZ}	Output Disable Time From High and Low Level	2	1.5	6.0	1.5	6.3	1.5	7.2	ns
			1.5	6.0	1.5	6.3	1.5	7.2	
t _s	Setup Time, HIGH or LOW D ⁿ to LE	3	2.5		2.5		3.0	ns	
t _h	Hold Time, HIGH or LOW D ⁿ to LE	3	1.5		1.5		2.0	ns	
t _w	LE Pulse Width, HIGH	3	3.0		3.0		3.5	ns	
t _{OSHL} t _{OSLH}	Output-to-Output Skew (Note 3)			1.0 1.0				ns	

3. Skew is defined as the absolute value of the difference between the actual propagation delay for any two separate outputs of the same device. The specification applies to any outputs switching in the same direction, either HIGH-to-LOW (t_{OSHL}) or LOW-to-HIGH (t_{OSLH}); parameter guaranteed by design.

MC74LCX16373

DYNAMIC SWITCHING CHARACTERISTICS

Symbol	Characteristic	Condition	T _A = +25°C			Units
			Min	Typ	Max	
V _{OLP}	Dynamic LOW Peak Voltage (Note 4)	V _{CC} = 3.3 V, C _L = 50 pF, V _{IH} = 3.3 V, V _{IL} = 0 V V _{CC} = 2.5 V, C _L = 30 pF, V _{IH} = 2.5 V, V _{IL} = 0 V		0.8 0.6		V
V _{OLV}	Dynamic LOW Valley Voltage (Note 4)	V _{CC} = 3.3 V, C _L = 50 pF, V _{IH} = 3.3 V, V _{IL} = 0 V V _{CC} = 2.5 V, C _L = 30 pF, V _{IH} = 2.5 V, V _{IL} = 0 V		-0.8 -0.6		V

4. Number of outputs defined as “n”. Measured with “n-1” outputs switching from HIGH-to-LOW or LOW-to-HIGH. The remaining output is measured in the LOW state.

CAPACITIVE CHARACTERISTICS

Symbol	Parameter	Condition	Typical	Units
C _{IN}	Input Capacitance	V _{CC} = 3.3 V, V _I = 0 V or V _{CC}	7	pF
C _{OUT}	Output Capacitance	V _{CC} = 3.3 V, V _I = 0 V or V _{CC}	8	pF
C _{PD}	Power Dissipation Capacitance	10 MHz, V _{CC} = 3.3 V, V _I = 0 V or V _{CC}	20	pF

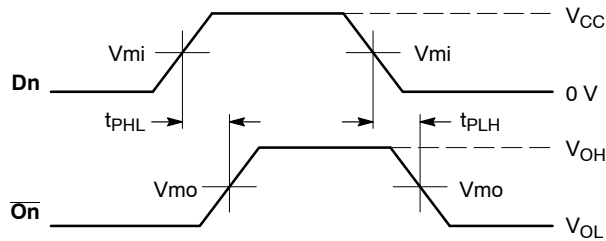

WAVEFORM 1 - PROPAGATION DELAYS

t_R = t_F = 2.5 ns, 10% to 90%; f = 1 MHz; t_W = 500 ns

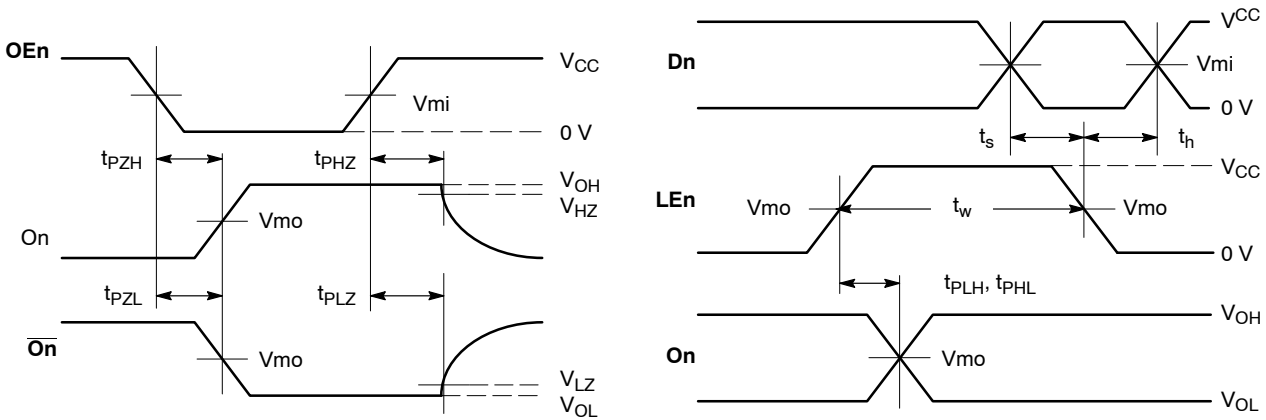

WAVEFORM 2 - OUTPUT ENABLE AND DISABLE TIMES

t_R = t_F = 2.5 ns, 10% to 90%; f = 1 MHz; t_W = 500 ns

WAVEFORM 3 - LE to On PROPAGATION DELAYS, LE MINIMUM PULSE WIDTH, Dn to LE SETUP AND HOLD TIMES

t_R = t_F = 2.5 ns, 10% to 90%; f = 1 MHz; t_W = 500 ns except when noted

Figure 3. AC Waveforms

Table 2. AC WAVEFORMS

Symbol	V _{CC}		
	3.3 V ± 0.3 V	2.7 V	2.5 V ± 0.2 V
V _{mi}	1.5 V	1.5 V	V _{CC} / 2
V _{mo}	1.5 V	1.5 V	V _{CC} / 2
V _{HZ}	V _{OL} + 0.3 V	V _{OL} + 0.3 V	V _{OL} + 0.15 V
V _{LZ}	V _{OH} - 0.3 V	V _{OH} - 0.3 V	V _{OH} - 0.15 V

MC74LCX16373

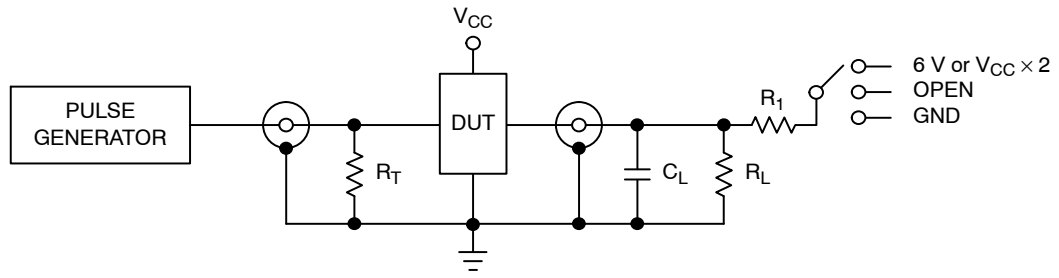

Figure 4. Test Circuit

Table 3. TEST CIRCUIT

Test	Switch
t_{PLH} , t_{PHL}	Open
t_{PZL} , t_{PLZ}	6 V at $V_{CC} = 3.3 \pm 0.3$ V 6 V at $V_{CC} = 2.5 \pm 0.2$ V
Open Collector/Drain t_{PLH} and t_{PHL}	6 V
t_{PZH} , t_{PHZ}	GND

$C_L = 50$ pF at $V_{CC} = 3.3 \pm 0.3$ V or equivalent (includes jig and probe capacitance)

$C_L = 30$ pF at $V_{CC} = 2.5 \pm 0.2$ V or equivalent (includes jig and probe capacitance)

$R_L = R_1 = 500 \Omega$ or equivalent

$R_T = Z_{OUT}$ of pulse generator (typically 50Ω)

MC74LCX16373

PACKAGE DIMENSIONS

TSSOP-48
DT SUFFIX
CASE 1201-01
ISSUE B

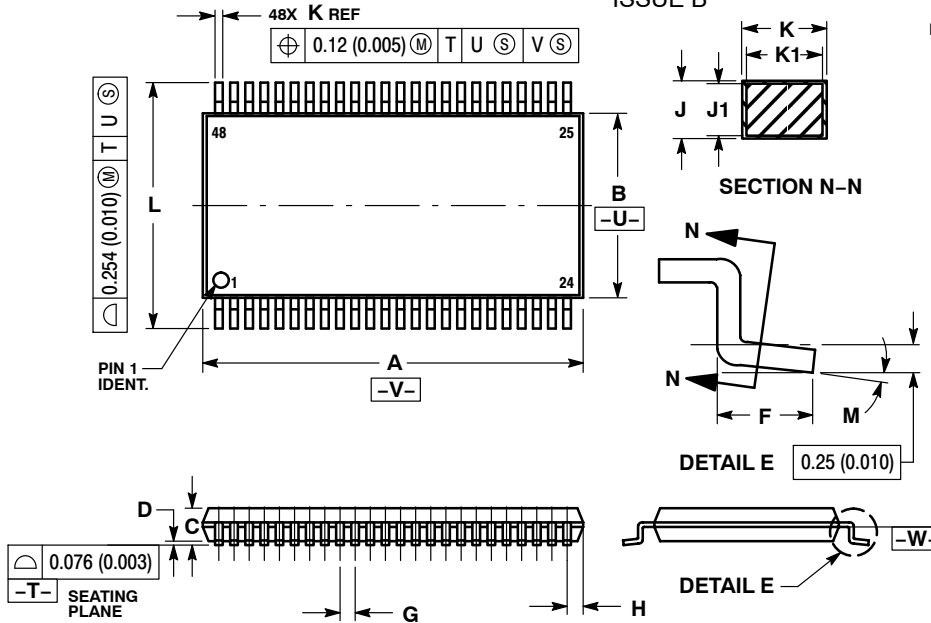

NOTES:

1. DIMENSIONING AND TOLERANCING PER ANSI Y14.5M, 1982.
2. CONTROLLING DIMENSION: MILLIMETER.
3. DIMENSIONS A AND B DO NOT INCLUDE MOLD FLASH, PROTRUSIONS OR GATE BURRS. MOLD FLASH OR GATE BURRS SHALL NOT EXCEED 0.15 (0.006) PER SIDE.
4. DIMENSION K DOES NOT INCLUDE DAMBAR PROTRUSION. ALLOWABLE DAMBAR PROTRUSION SHALL BE 0.08 (0.003) TOTAL IN EXCESS OF THE K DIMENSION AT MAXIMUM MATERIAL CONDITION.
5. TERMINAL NUMBERS ARE SHOWN FOR REFERENCE ONLY.
6. DIMENSIONS A AND B ARE TO BE DETERMINED AT DATUM PLANE -W-.

DIM	MILLIMETERS		INCHES	
	MIN	MAX	MIN	MAX
A	12.40	12.60	0.488	0.496
B	6.00	6.20	0.236	0.244
C	---	1.10	---	0.043
D	0.05	0.15	0.002	0.006
F	0.50	0.75	0.020	0.030
G	0.50 BSC		0.0197 BSC	
H	0.37	---	0.015	---
J	0.09	0.20	0.004	0.008
J1	0.09	0.16	0.004	0.006
K	0.17	0.27	0.007	0.011
K1	0.17	0.23	0.007	0.009
L	7.95	8.25	0.313	0.325
M	0°	8°	0°	8°

RECOMMENDED SOLDERING FOOTPRINT

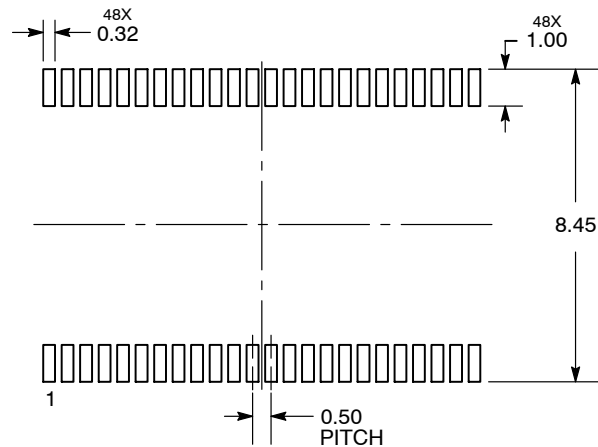

DIMENSIONS: MILLIMETERS

ON Semiconductor and are registered trademarks of Semiconductor Components Industries, LLC (SCILLC). SCILLC owns the rights to a number of patents, trademarks, copyrights, trade secrets, and other intellectual property. A listing of SCILLC's product/patent coverage may be accessed at www.onsemi.com/site/pdf/Patent-Marking.pdf. SCILLC reserves the right to make changes without further notice to any products herein. SCILLC makes no warranty, representation or guarantee regarding the suitability of its products for any particular purpose, nor does SCILLC assume any liability arising out of the application or use of any product or circuit, and specifically disclaims any and all liability, including without limitation special, consequential or incidental damages. "Typical" parameters which may be provided in SCILLC data sheets and/or specifications can and do vary in different applications and actual performance may vary over time. All operating parameters, including "Typicals" must be validated for each customer application by customer's technical experts. SCILLC does not convey any license under its patent rights nor the rights of others. SCILLC products are not designed, intended, or authorized for use as components in systems intended for surgical implant into the body, or other applications intended to support or sustain life, or for any other application in which the failure of the SCILLC product could create a situation where personal injury or death may occur. Should Buyer purchase or use SCILLC products for any such unintended or unauthorized application, Buyer shall indemnify and hold SCILLC and its officers, employees, subsidiaries, affiliates, and distributors harmless against all claims, costs, damages, and expenses, and reasonable attorney fees arising out of, directly or indirectly, any claim of personal injury or death associated with such unintended or unauthorized use, even if such claim alleges that SCILLC was negligent regarding the design or manufacture of the part. SCILLC is an Equal Opportunity/Affirmative Action Employer. This literature is subject to all applicable copyright laws and is not for resale in any manner.

PUBLICATION ORDERING INFORMATION

LITERATURE FULFILLMENT:
Literature Distribution Center for ON Semiconductor
P.O. Box 5163, Denver, Colorado 80217 USA
Phone: 303-675-2175 or 800-344-3860 Toll Free USA/Canada
Fax: 303-675-2176 or 800-344-3867 Toll Free USA/Canada
Email: orderlit@onsemi.com

N. American Technical Support: 800-282-9855 Toll Free
USA/Canada
Europe, Middle East and Africa Technical Support:
Phone: 421 33 790 2910
Japan Customer Focus Center
Phone: 81-3-5817-1050

ON Semiconductor Website: www.onsemi.com
Order Literature: <http://www.onsemi.com/orderlit>
For additional information, please contact your local Sales Representative