

## GLASS PASSIVATED BRIDGE RECTIFIERS

REVERSE VOLTAGE - **50 to 1000** Volts

FORWARD CURRENT - **1.5** Amperes

**KBP**

### FEATURES

- Rating to 1000V PRV
- Ideal for printed circuit board
- Reliable low cost construction utilizing molded plastic technique
- The plastic material has UL flammability classification 94V#0

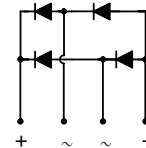
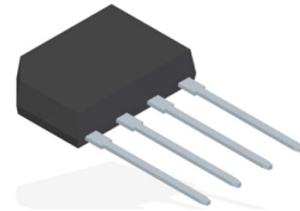

### MECHANICAL DATA

- Polarity : As marked on body
- Weight : 0.05 ounces, 1.52 grams
- Mounting position : Any

## MAXIMUM RATINGS AND ELECTRICAL CHARACTERISTICS

Ratings at 25°C ambient temperature unless otherwise specified.

CHARACTERISTICS	SYMBOL	KBP 005G	KBP 01G	KBP 02G	KBP 04G	KBP 06G	KBP 08G	KBP 10G	UNIT
Maximum Recurrent Peak Reverse Voltage	V <sub>RRM</sub>	50	100	200	400	600	800	1000	V
Maximum RMS Voltage	V <sub>RMS</sub>	35	70	140	280	420	560	700	V
Maximum DC Blocking Voltage	V <sub>DC</sub>	50	100	200	400	600	800	1000	V
Maximum Average Forward Rectified Current @T <sub>C</sub> = 105 °C @T <sub>A</sub> = 75 °C	I <sub>(AV)</sub>	1.5							A
Peak Forward Surge Current 8.3ms single half sine wave superimposed on rated load	I <sub>FSM</sub>	45							A
Maximum forward Voltage at 1.5A DC	V <sub>F</sub>	1.1							V
Maximum DC Reverse Current at Rated DC Blocking Voltage @T <sub>J</sub> = 25 °C @T <sub>J</sub> = 125 °C	I <sub>R</sub>	5.0 500							uA
I <sup>2</sup> t Rating for fusing (t < 8.3ms)	I <sup>2</sup> t	6.6							A <sup>2</sup> S
Typical Junction Capacitance per element (Note 1)	C <sub>J</sub>	20							pF
Typical Thermal Resistance (Note 2)	R <sub>θ JC</sub>	18							°C/W
Operating Temperature Range	T <sub>J</sub>	-55 to 150							°C
Storage Temperature Range	T <sub>STG</sub>	-55 to 150							°C

NOTES : 1. Measured at 1.0MHz and applied reverse voltage of 4.0VDC.

2. Unit Mounted on 75mm x 75mm x 1.6mm Cu Plate Heatsink.

FIG.1 #FORWARD CURRENT DERATING CURVE

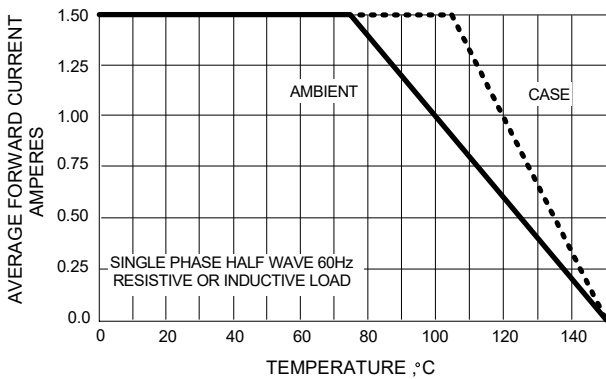

FIG.2 #MAXIMUM NON-REPETITIVE SURGE CURRENT

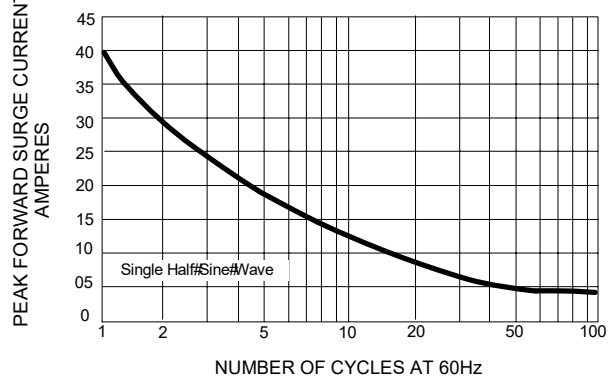

FIG.3 #TYPICAL JUNCTION CAPACITANCE

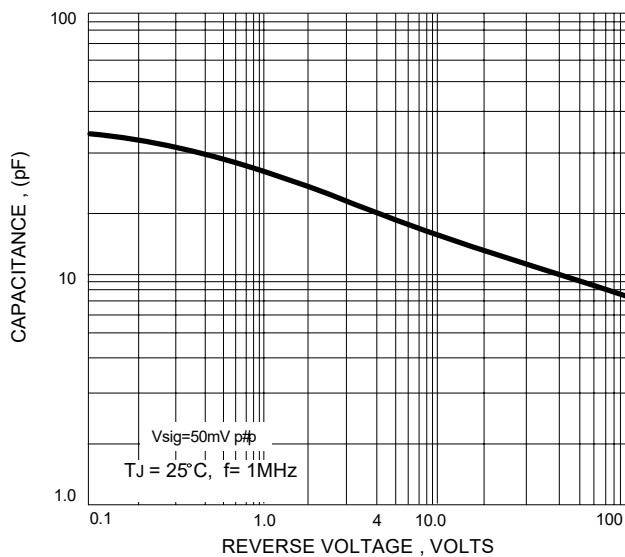

FIG.4 #TYPICAL FORWARD CHARACTERISTICS

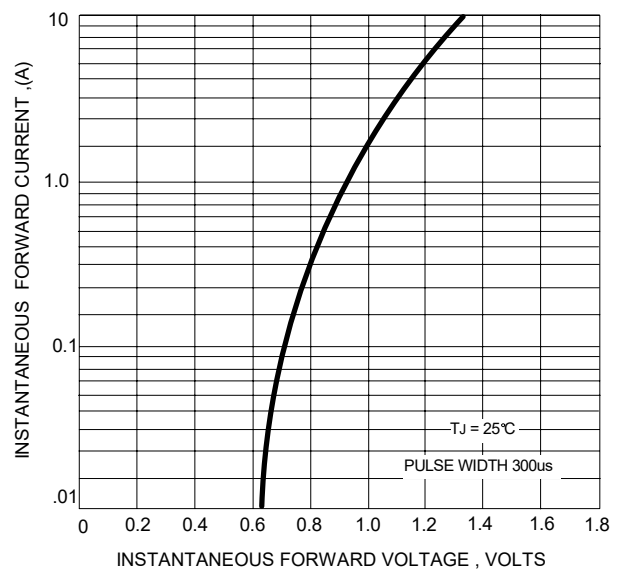
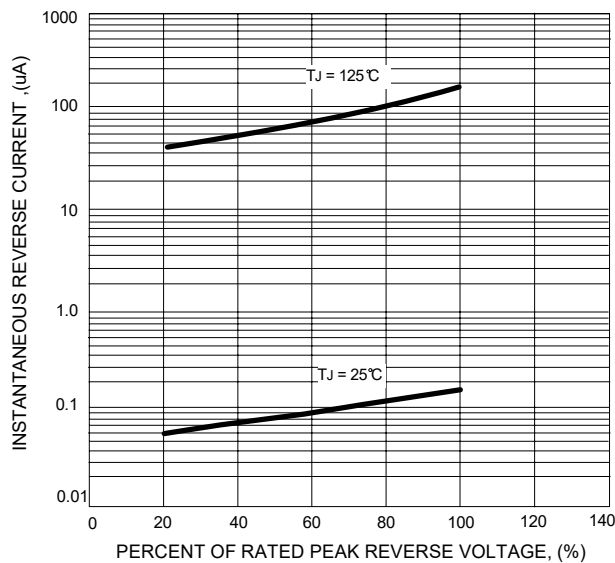
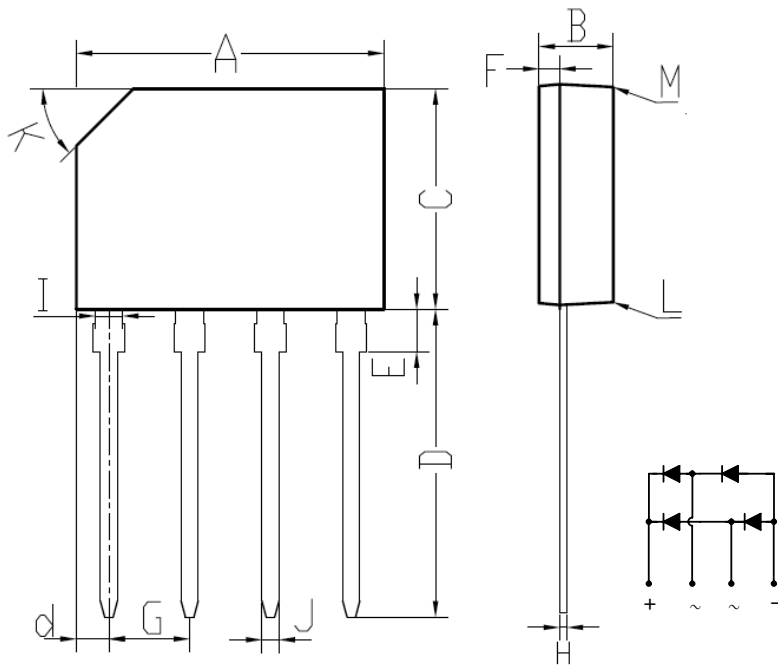

FIG.5 #TYPICAL REVERSE CHARACTERISTICS



## KBP Package Outline Dimensions



KBP		
DIM.	MIN.	MAX.
A	14.25	14.75
B	3.35	3.65
C	10.20	10.60
D	14.25	14.73
d	1.40	1.70
E	1.80	2.20
F	0.80	1.10
G	3.56	4.06
H	0.35	0.55
I	1.22	1.42
J	0.76	0.86
K	2.7 x 45° (Typ)	
L	#	3°
M	#	2°
All Dimensions in millimeter		