

SE1991G

N-Channel Enhancement-Mode MOSFET

Revision: A

General Description

This series is a high voltage power MOSFET and is designed to have better characteristics, such as fast switching time, low gate charge, low on-state resistance and have a high rugged avalanche characteristics

Features

For a single MOSFET

- $V_{DS} = 100V$
- $R_{DS(ON)} = 3.8m\Omega @ V_{GS}=10V$

Pin configurations

See Diagram below

P/N	PACKAGE
SE1991G	TO-263
SE1991GA	TO-220

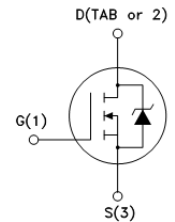
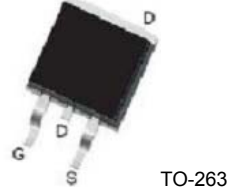
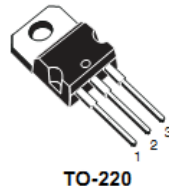

Absolute Maximum Ratings

Parameter		Symbol	Rating	Units
Drain-Source Voltage		V_{DS}	100	V
Gate-Source Voltage		V_{GS}	± 20	V
Drain Current ¹	Continuous	I_D	120	A
	Pulsed		480	
Single Pulse Avalanche Energy		E_{AS}	609	mJ
Power Dissipation		P_D	223	W
Operating Junction Temperature Range		T_J	-55 to 150	$^{\circ}C$

Thermal Resistance

Symbol	Parameter	Value	Units
$R_{\theta JA}$	Junction to Ambient	62	$^{\circ}C/W$

SE1991G

Electrical Characteristics (T _J =25°C unless otherwise noted)						
Symbol	Parameter	Test Conditions	Min	Typ	Max	Units
OFF CHARACTERISTICS						
B _V DSS	Drain-Source Breakdown Voltage	V _{GS} =0 V, I _D =250μA,	100			V
I _{DSS}	Drain to Source Leakage Current	V _{DS} = 80V, V _{GS} =0V			1.0	μA
I _{GSS}	Gate-Body Leakage Current	V _{GS} =20 V			100	nA
V _{GS(th)}	Gate Threshold Voltage	V _{DS} = V _{GS} , I _D =250μA	2.0	2.9	4.0	V
R _{DS(ON)}	Static Drain-Source On-Resistance	V _{GS} =10V, I _D =50A		3.8	5.0	mΩ
g _{FS}	Forward Transconductance	V _{DS} =10V, I _D =50A		140		S
DYNAMIC PARAMETERS						
C _{iss}	Input Capacitance	V _{GS} =0V, V _{DS} =40V, f=1MHz		7300		pF
C _{oss}	Output Capacitance			1360		pF
C _{rss}	Reverse Transfer Capacitance			50		pF
SWITCHING PARAMETERS						
Q _g	Total Gate Charge ²	V _{GS} =10V, V _{DD} =50V, I _D =50A		115		nC
Q _{gs}	Gate Source Charge			28		nC
Q _{gd}	Gate Drain Charge			26		nC
t _{d(on)}	Turn-On Delay Time	V _{DD} =50V, R _{GEN} =3.0Ω I _D =50A		30		ns
t _{d(off)}	Turn-Off Delay Time			99		ns
t _{d(r)}	Turn-On Rise Time			20		ns
t _{d(f)}	Turn-Off Fall Time			37		ns
Source-Drain Diode Characteristics						
V _{SD}	Drain-Source Diode Forward Voltage	V _{GS} =0V, I _S =50A		0.9	1.2	V
t _{rr}	Reverse Recovery Time	V _{GS} =0V, I _S =50A		73		ns
Q _{RR}	Reverse Recovery Charge	dI _F /dt=100A/μs ¹		150		nC

Typical Characteristics

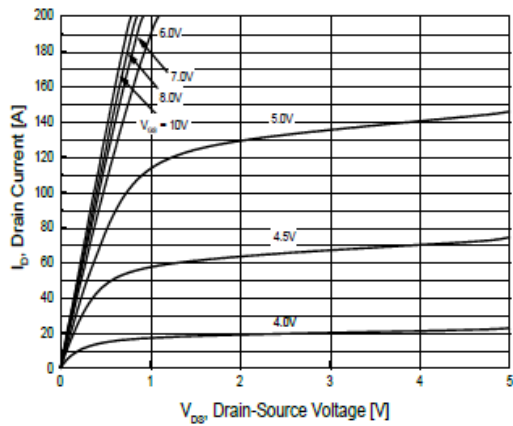

Fig.1 On-Region Characteristics

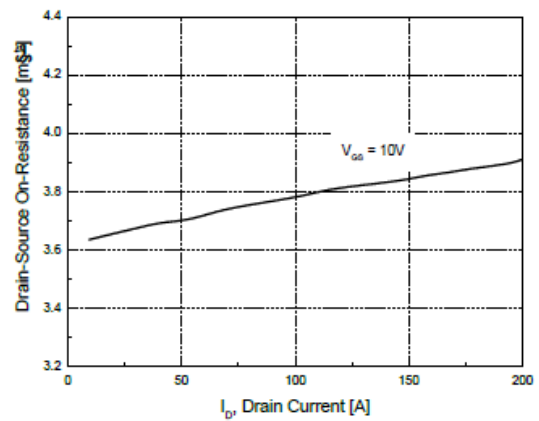

Fig.2 On-Resistance Variation with Drain Current and Gate Voltage

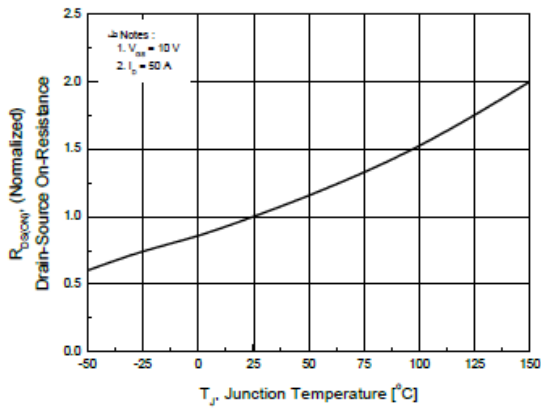

Fig.3 On-Resistance Variation with Temperature

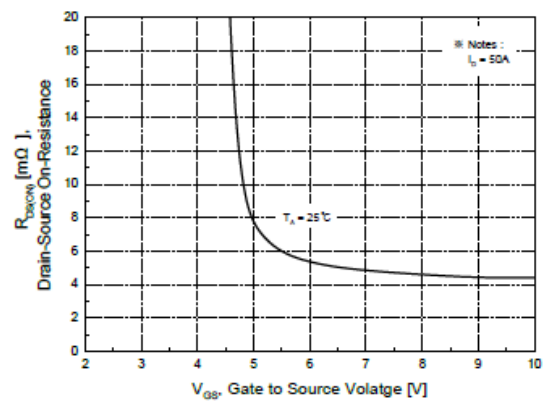

Fig.4 On-Resistance Variation with Gate to Source Voltage

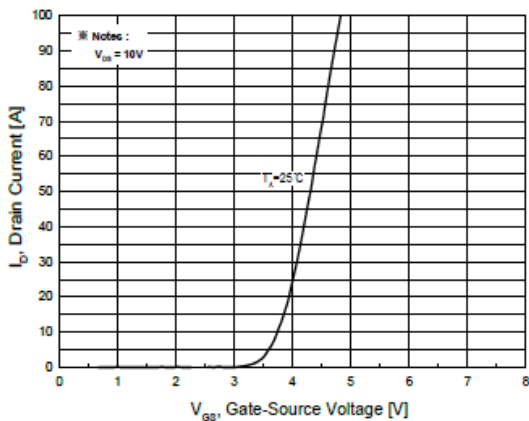

Fig.5 Transfer Characteristics

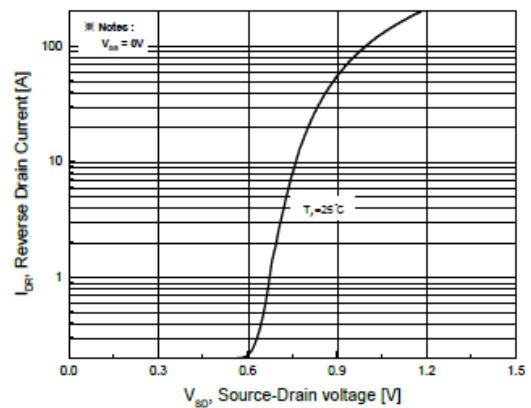

Fig.6 Body Diode Forward Voltage Variation with Source Current and Temperature

Typical Characteristics

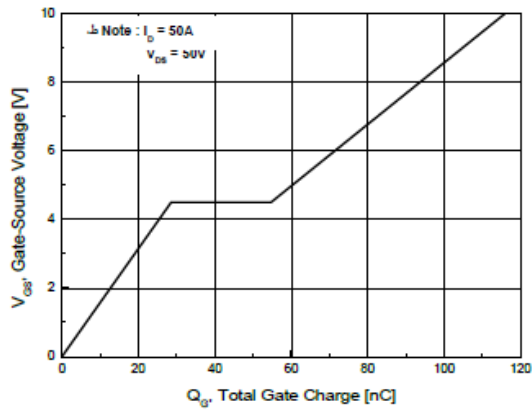

Fig.7 Gate Charge Characteristics

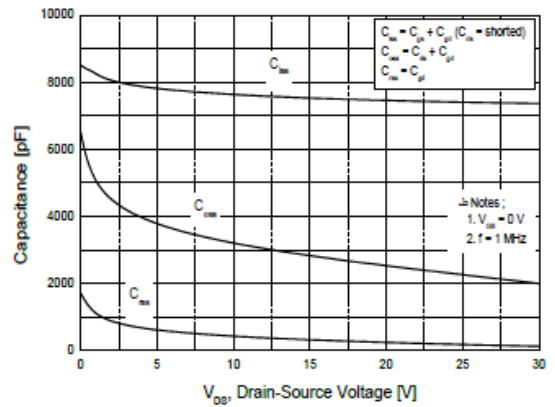

Fig.8 Capacitance Characteristics

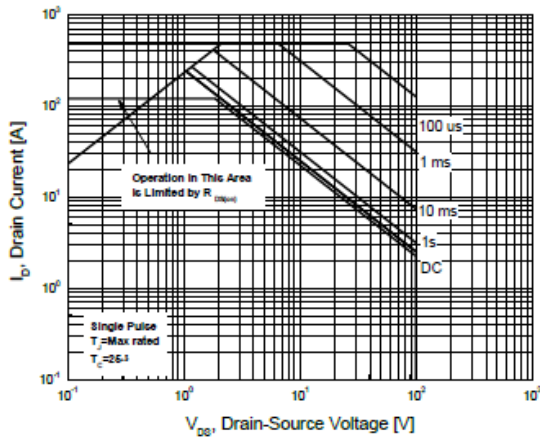

Fig.9 Maximum Safe Operating Area

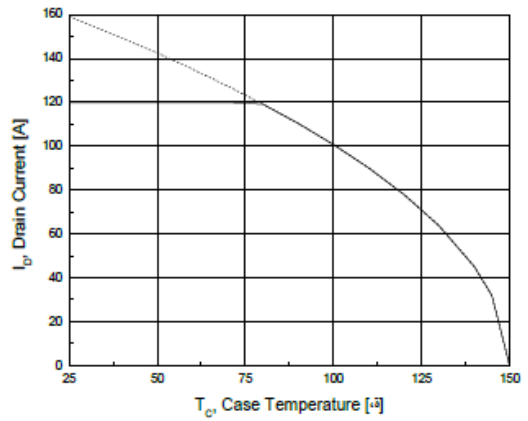

Fig.10 Maximum Drain Current vs. Case Temperature

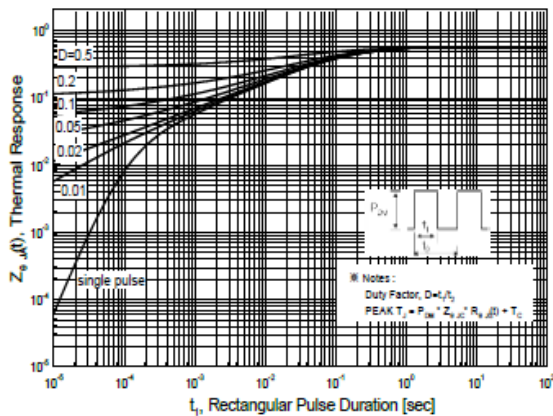
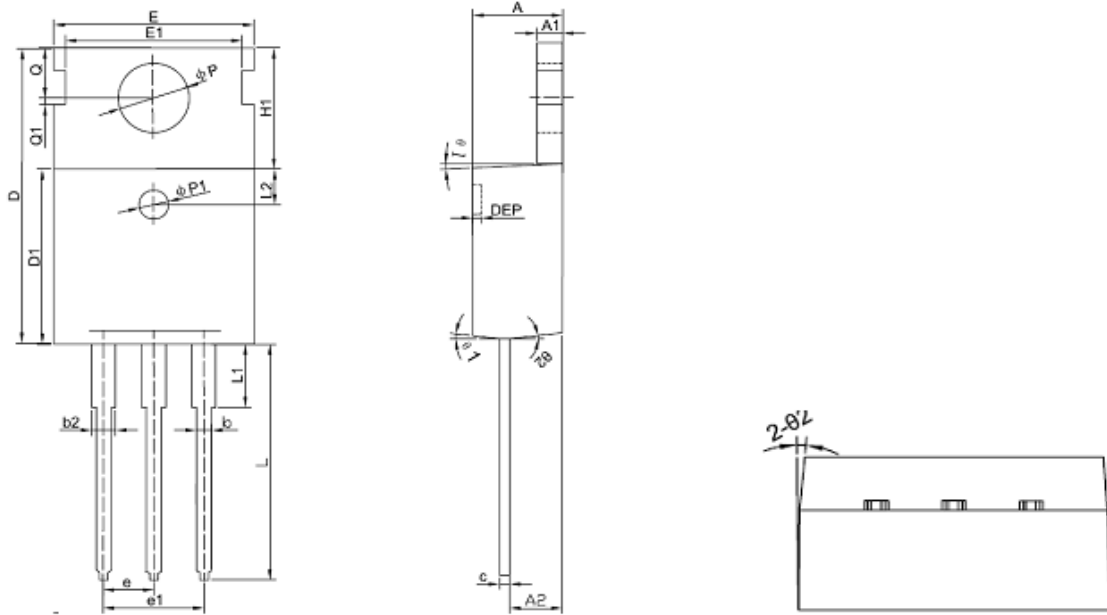

Fig.11 Transient Thermal Response Curve

SE1991G

Package Outline Dimension

TO-220



Symbol	Dimension In Millimeters			Dimension In Inches		
	Min	Nom	Max	Min	Nom	Max
A	4.400	4.550	4.700	0.173	0.179	0.185
A1	1.270	1.300	1.330	0.050	0.051	0.052
A2	2.590	2.690	2.790	0.102	0.106	0.110
b	0.770	-	0.900	0.030	-	0.035
b2	1.230	-	1.360	0.048	-	0.054
c	0.480	0.500	0.520	0.019	0.020	0.020
D	15.100	15.400	15.700	-	0.606	-
D1	9.000	9.100	9.200	0.354	0.358	0.362
DEP	0.050	0.285	0.520	0.002	0.011	0.020
E	10.060	10.160	10.260	0.396	0.400	0.404
E1	-	8.700	-	-	0.343	-
$\Phi P1$	1.400	1.500	1.600	0.055	0.059	0.063
e	2.54BSC			0.1BSC		
e1	5.08BSC			0.2BSC		
H1	6.100	6.300	6.500	0.240	0.248	0.256
L	12.750	12.960	13.170	0.502	0.510	0.519
L1	-	-	3.950	-	-	0.156
L2	1.85REF			0.073REF		
ΦP	3.570	3.600	3.630	0.141	0.142	0.143
Q	2.730	2.800	2.870	0.107	0.110	0.113
Q1	-	0.200	-	-	0.008	-
$\theta 1$	5°	7°	9°	5°	7°	9°
$\theta 2$	1°	3°	5°	1°	3°	5°

TO-263

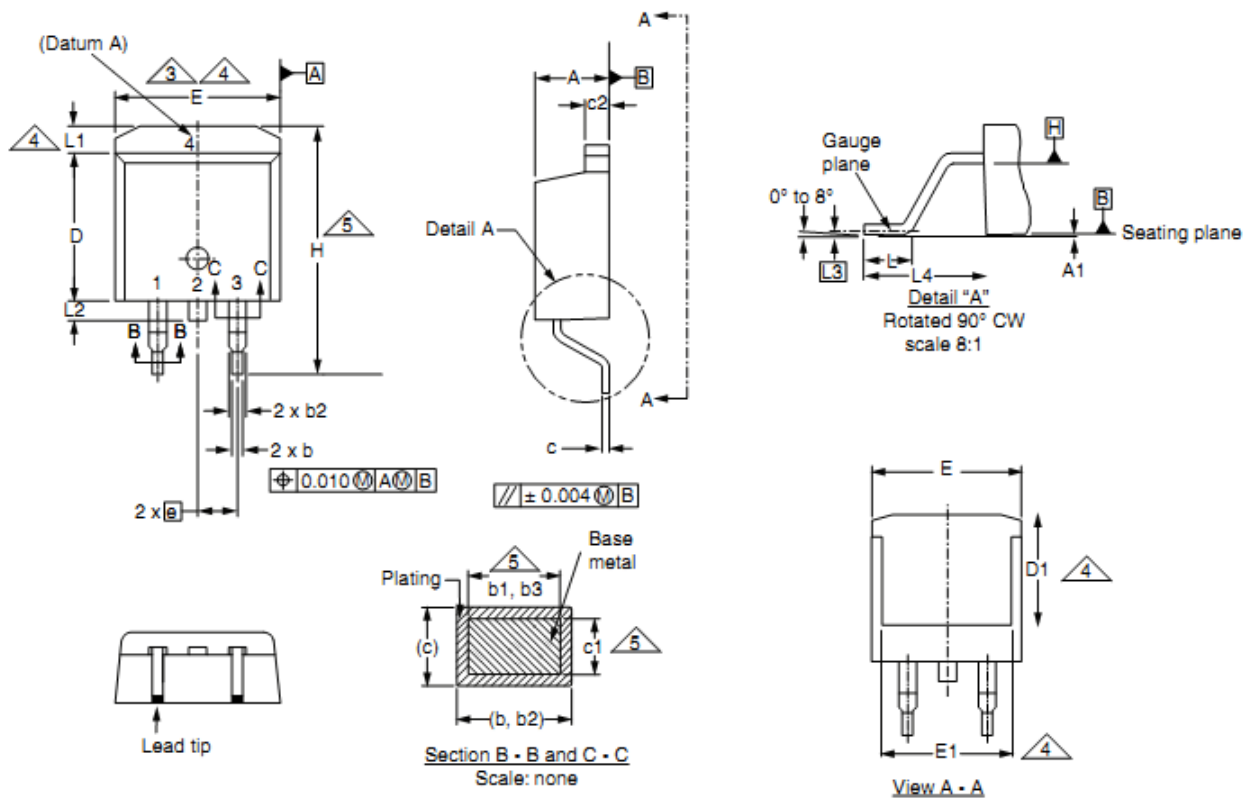

DIM.	MILLIMETERS		INCHES	
	MIN.	MAX.	MIN.	MAX.
A	4.06	4.83	0.160	0.190
A1	0.00	0.25	0.000	0.010
b	0.51	0.99	0.020	0.039
b1	0.51	0.89	0.020	0.035
b2	1.14	1.78	0.045	0.070
b3	1.14	1.73	0.045	0.068
c	0.38	0.74	0.015	0.029
c1	0.38	0.58	0.015	0.023
c2	1.14	1.65	0.045	0.065
D	8.38	9.65	0.330	0.380

DIM.	MILLIMETERS		INCHES	
	MIN.	MAX.	MIN.	MAX.
D1	6.86	-	0.270	-
E	9.65	10.67	0.380	0.420
E1	6.22	-	0.245	-
e	2.54 BSC		0.100 BSC	
H	14.61	15.88	0.575	0.625
L	1.78	2.79	0.070	0.110
L1	-	1.65	-	0.066
L2	-	1.78	-	0.070
L3	0.25 BSC		0.010 BSC	
L4	4.78	5.28	0.188	0.208

The SINO-IC logo is a registered trademark of ShangHai Sino-IC Microelectronics Co., Ltd.

© 2005 SINO-IC - Printed in China - All rights reserved.

SHANGHAI SINO-IC MICROELECTRONICS CO., LTD

Add: Building 3, Room 3401-03, No.200 Zhangheng Road,
ZhangJiang Hi-Tech Park, Pudong, Shanghai 201203, China

Phone: +86-21-33932402 33932403

33932405 33933508 33933608

Fax: +86-21-33932401

Email: webmaster@sino-ic.com

Website: <http://www.sino-ic.com>