

**SE2N7002**  
**60V,300mA N-Channel MOSFET**

Revision:A

**General Description**

The MOSFETs from SINO-IC provide the best combination of fast switching, low on-resistance and cost-effectiveness.

**Features**

- $V_{DS(V)} = 60V$
- $I_D = 300mA$
- $R_{DS(ON)} < 2\Omega$  ( $V_{GS} = 10V, I_D = 0.5A$ )
- $R_{DS(ON)} < 3\Omega$  ( $V_{GS} = 5V, I_D = 0.05A$ )

**Pin configurations**

See Diagram below

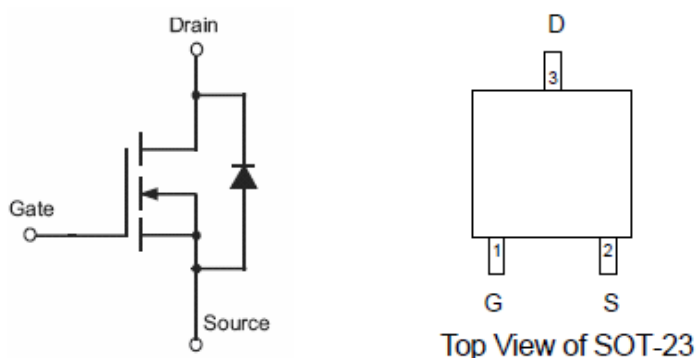

**Absolute Maximum Ratings**

Parameter		Symbol	Rating	Units
Drain-Source Voltage		$V_{DS}$	60	V
Gate-Source Voltage		$V_{GS}$	$\pm 20$	V
Drain Current (Note 1)	Continuous	$I_D$	300	mA
	Pulsed		800	
Total Power Dissipation		$P_D$	350	mW
Operating Junction Temperature Range		$T_J$	-55 to 150	$^{\circ}C$

**Thermal Characteristics**

Parameter		Symbol	Typ	Max	Units
Maximum Junction-to-Ambient A	$t \leq 5s$	$R_{\theta JA}$	357	-	$^{\circ}C/W$

**Electrical Characteristics (T<sub>J</sub>=25°C unless otherwise noted)**

Symbol	Parameter	Test Conditions	Min	Typ	Max	Units
<b>OFF/ON CHARACTERISTICS (Note 2)</b>						
BV <sub>DSS</sub>	Drain-Source Breakdown Voltage	I <sub>D</sub> =10 μA, V <sub>GS</sub> =0V	60			V
I <sub>DSS</sub>	Zero Gate Voltage Drain Current	V <sub>DS</sub> =60V, V <sub>GS</sub> =0V			1	μA
I <sub>GSS</sub>	Gate-Body leakage current	V <sub>DS</sub> =0V, V <sub>GS</sub> =±20V			±10	μA
V <sub>GS(th)</sub>	Gate Threshold Voltage	V <sub>DS</sub> =V <sub>GS</sub> I <sub>D</sub> =250uA	0.45		0.85	V
R <sub>DS(ON)</sub>	Static Drain-Source On-Resistance2	V <sub>GS</sub> =10V, I <sub>D</sub> =0.5A		2	-	Ω
		V <sub>GS</sub> =5V, I <sub>D</sub> =0.05A		3	-	Ω
Y <sub>fs</sub>	Forward Transfer Admittance	V <sub>GS</sub> = 10 V, I <sub>S</sub> = 0.2 A	80			ms
<b>DYNAMIC PARAMETERS</b>						
C <sub>iss</sub>	Input Capacitance	V <sub>GS</sub> =0V, V <sub>DS</sub> =25V, f=1MHz			50	pF
C <sub>oss</sub>	Output Capacitance				25	pF
C <sub>rss</sub>	Reverse Transfer Capacitance				5	pF

**Typical Characteristics**

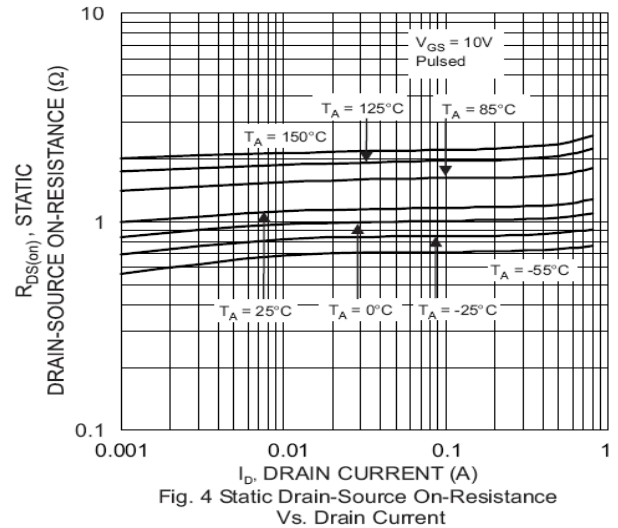
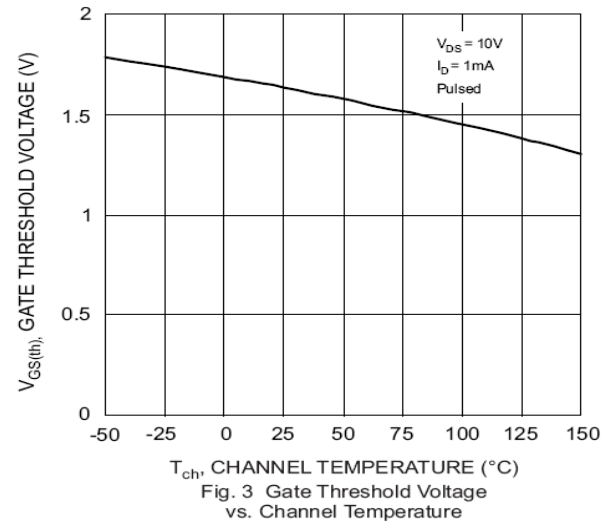
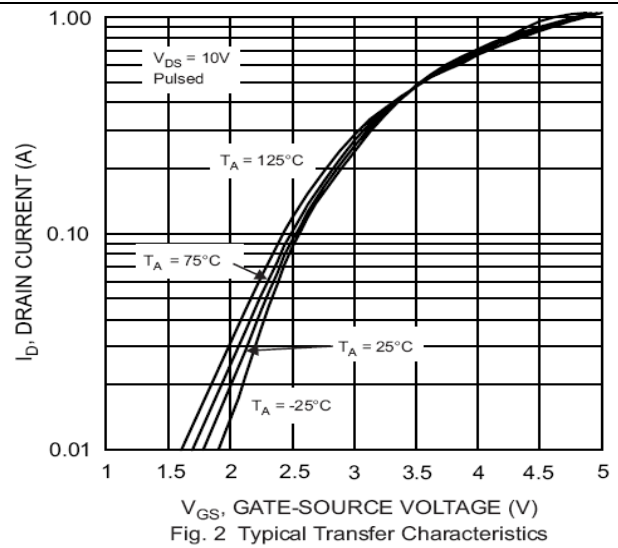
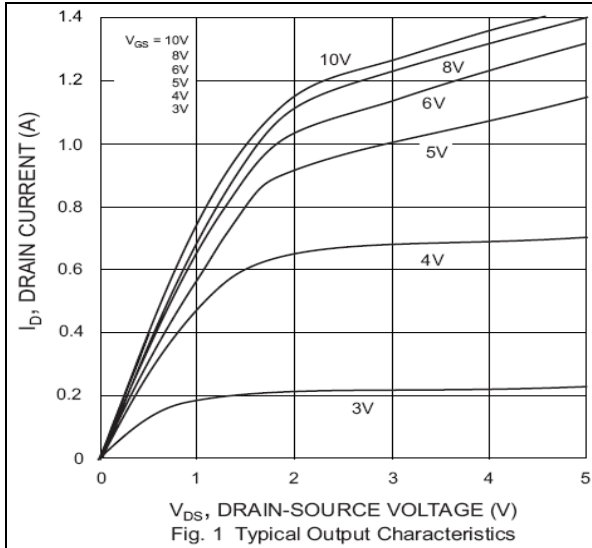

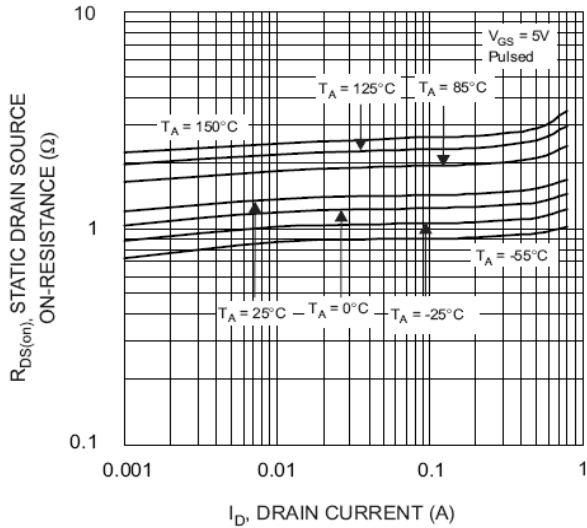

Fig. 5 Static Drain-Source On-Resistance vs. Drain Current

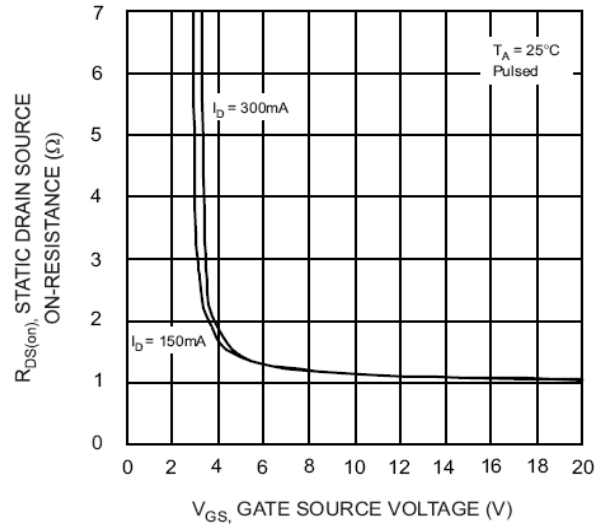

Fig. 6 Static Drain-Source On-Resistance vs. Gate-Source Voltage

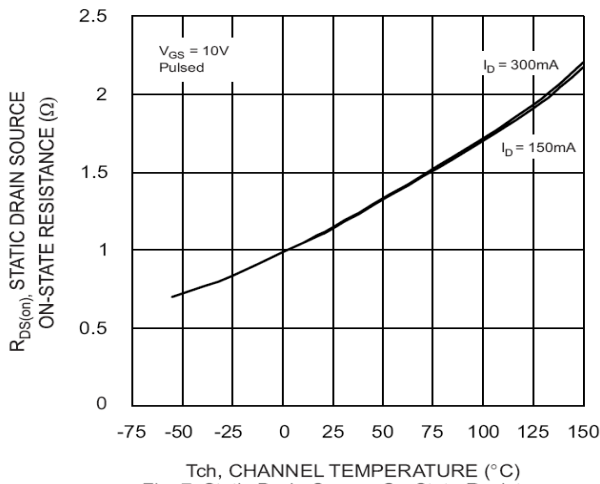

Fig. 7 Static Drain-Source On-State Resistance vs. Channel Temperature

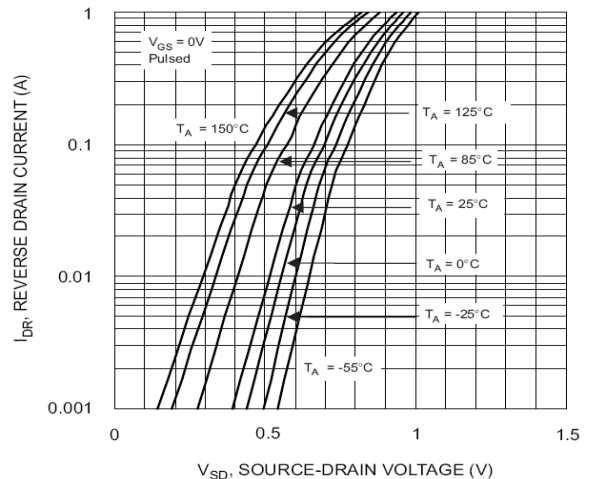

Fig. 8 Reverse Drain Current vs. Source-Drain Voltage

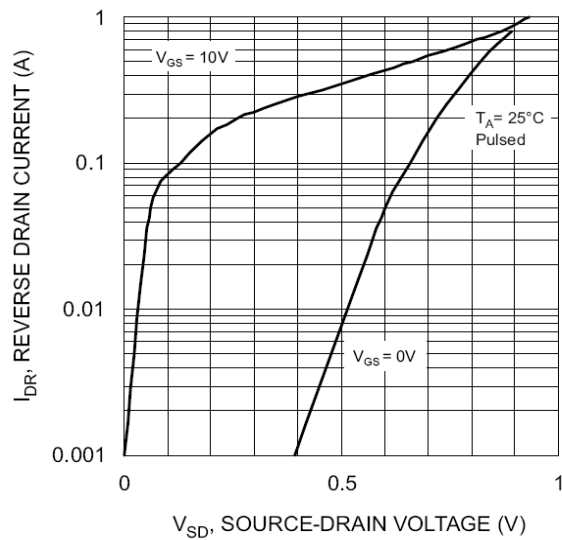

Fig. 9 Reverse Drain Current vs. Source-Drain Voltage

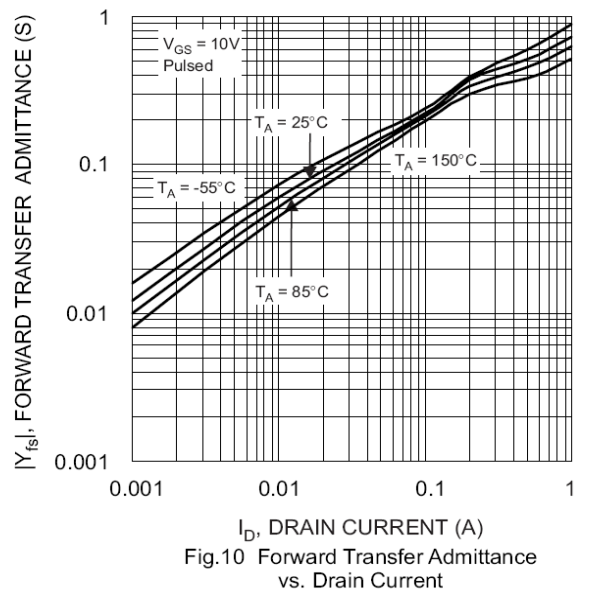

Fig. 10 Forward Transfer Admittance vs. Drain Current

**The SINO-IC logo is a registered trademark of ShangHai Sino-IC Microelectronics Co., Ltd.**

**© 2005 SINO-IC – Printed in China – All rights reserved.**

**SHANGHAI SINO-IC MICROELECTRONICS CO., LTD**

**Add:** Building 3, Room 3401-03, No.200 Zhangheng Road, ZhangJiang Hi-Tech Park, Pudong, Shanghai 201203, China

**Phone:** +86-21-33932402 33932403 33932405 33933508 33933608

**Fax:** +86-21-33932401

**Email:** [webmaster@sino-ic.com](mailto:webmaster@sino-ic.com)

**Website:** <http://www.sino-ic.com>