

SE7314
Dual-20V P-Channel Enhancement-Mode MOSFET

Revision:A

General Description

SE7314 is produced with high cell density DMOS trench technology, which is especially used to minimize on-state resistance. This device particularly suits low voltage applications such as portable equipment, power management and other battery powered circuits, and low in-line power dissipation are needed in a very small outline surface mount

Features

- $V_{DS} = -20V$
- $R_{DS(on)} = 68m\Omega @ V_{GS} = -1.8V, I_D = -2A$
- $R_{DS(on)} = 52m\Omega @ V_{GS} = -2.5V, I_D = -4.1A$
- $R_{DS(on)} = 39m\Omega @ V_{GS} = -4.5V, I_D = -4.7A$

Application

- Load Switch
- A Switch and Battery Switch for Portable Devices

Pin configurations(SOP8)

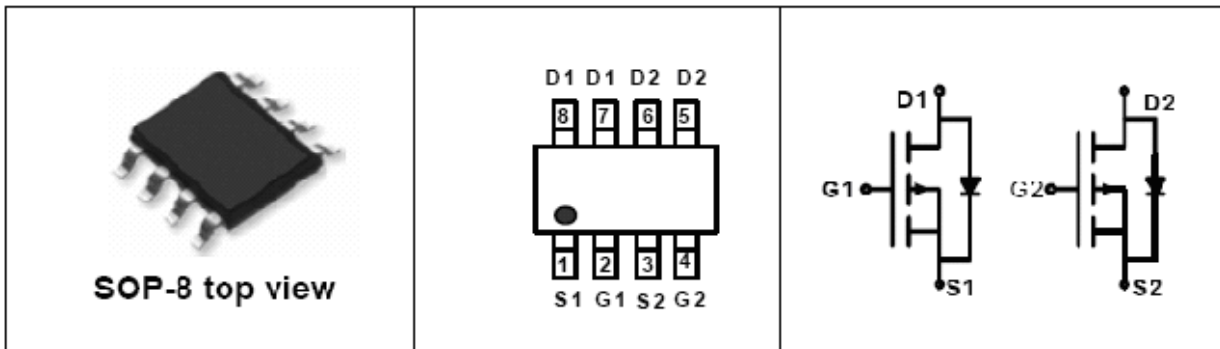

Absolute Maximum Ratings

Parameter		Symbol	Rating	Units
Drain-Source Voltage		V_{DS}	-20	V
Gate-Source Voltage		V_{GS}	± 12	V
Drain Current (Note 1)	Continuous	I_D	-4.7	A
	Pulsed		-20	
Total Power Dissipation	@TA=25°C	P_D	1.25	W
	@TA=75°C		0.8	
Operating Junction Temperature Range		T_J	-55 to 150	°C

Electrical Characteristics (T _J =25°C unless otherwise noted)						
Symbol	Parameter	Test Conditions	Min	Typ	Max	Units
OFF CHARACTERISTICS (Note 2)						
BVDSS	Drain-Source Breakdown Voltage	I _D =-250μA, V _{GS} =0 V	-20	-	-	V
IDSS	Zero Gate Voltage Drain Current	V _{DS} =-16 V, V _{GS} =0 V	-	-	1	μA
IGSS	Gate-Body leakage current	V _{DS} =0 V, V _{GS} =±8 V	-	-	±100	μA
V _{GS(th)}	Gate Threshold Voltage	V _{DS} =V _{GS} I _D =-250μA	-0.4	-	-1	V
R _{DS(ON)}	Static Drain-Source On-Resistance ²	V _{GS} =-1.8V, I _D =-2A	-	45	68	mΩ
		V _{GS} =-2.50V, I _D =-4.1A		35	52	
		V _{GS} =-4.5V, I _D =-4.7A	-	30	39	
DYNAMIC PARAMETERS						
C _{iss}	Input Capacitance	V _{GS} =0V, V _{DS} =-10V, f=1MHz	-	1020	-	pF
C _{oss}	Output Capacitance		-	191	-	pF
C _{rss}	Reverse Transfer Capacitance		-	140	-	pF
SWITCHING PARAMETERS						
t _{d(on)}	Turn-On DelayTime ²	V _{GS} =-10V, V _{GEN} =-4.5V, R _L =10Ω, R _G =6Ω	-	25	50	ns
t _{d(off)}	Turn-Off DelayTime		I _D =-1A	-	71	
V _{SD}	Drain-Source Diode Forward Voltage	V _{GS} =0V, I _S =-1		-	-1.2	V

Typical Characteristics

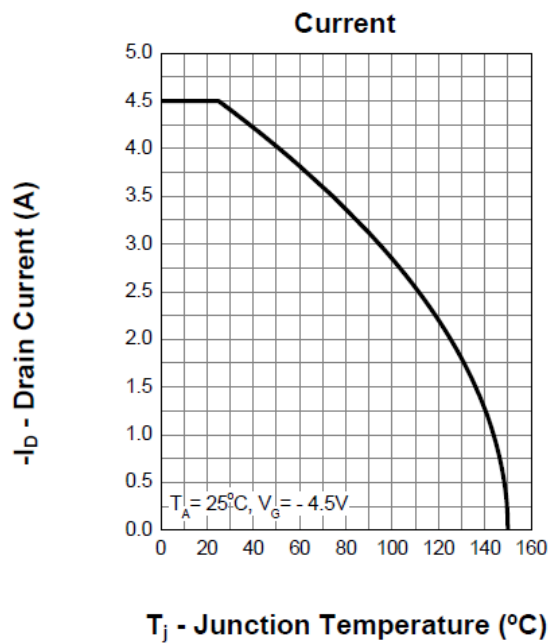
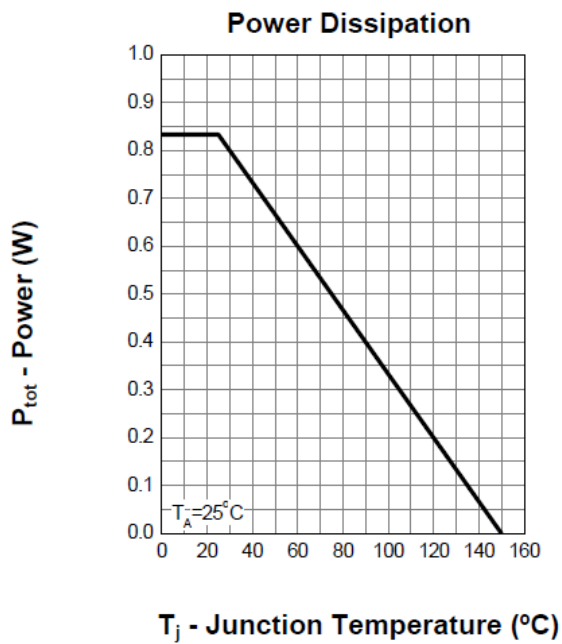

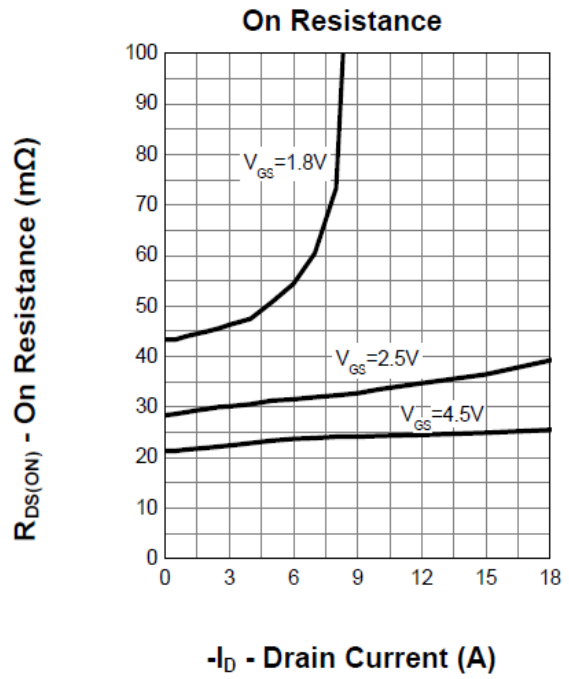
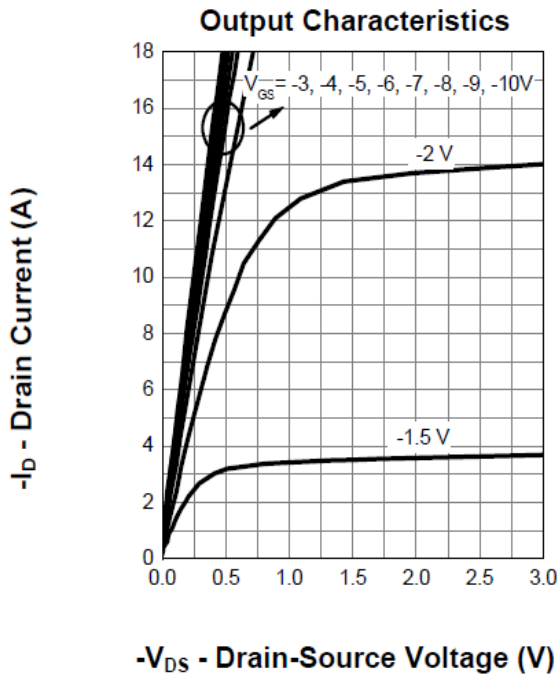
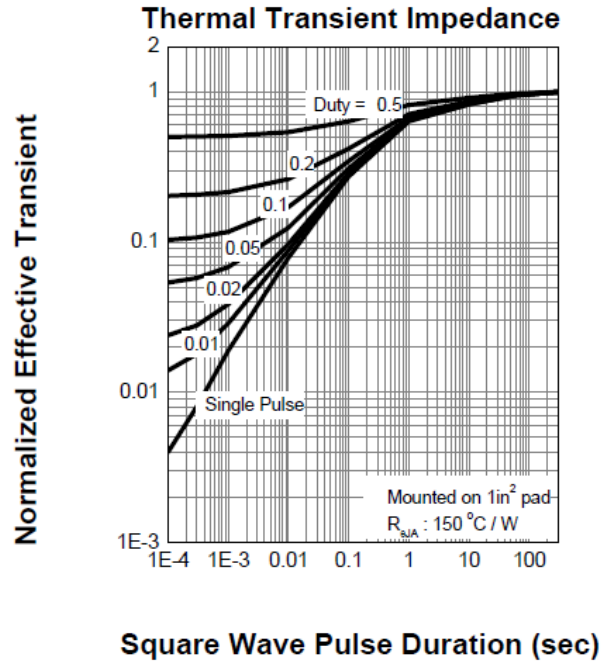
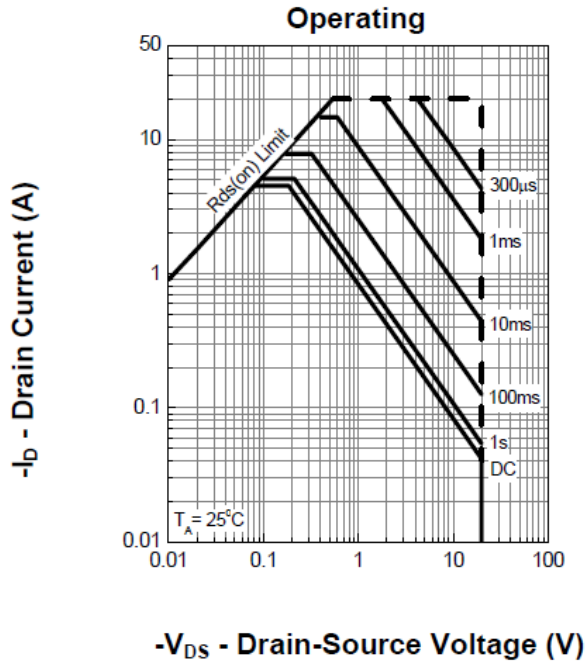

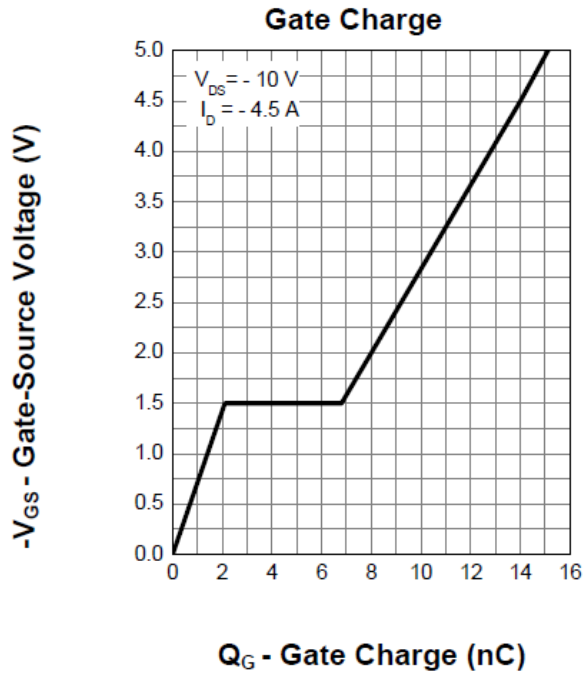
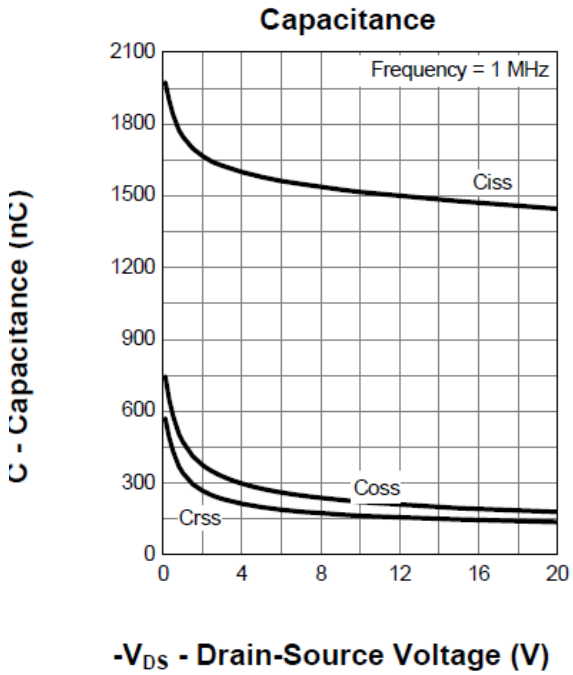
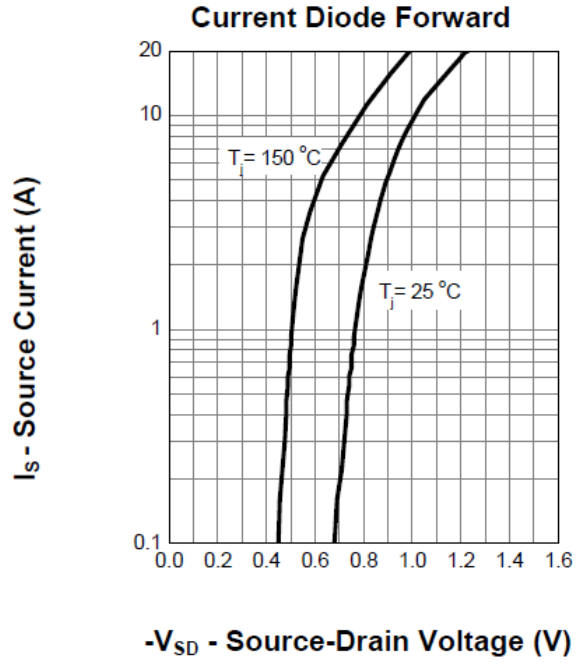
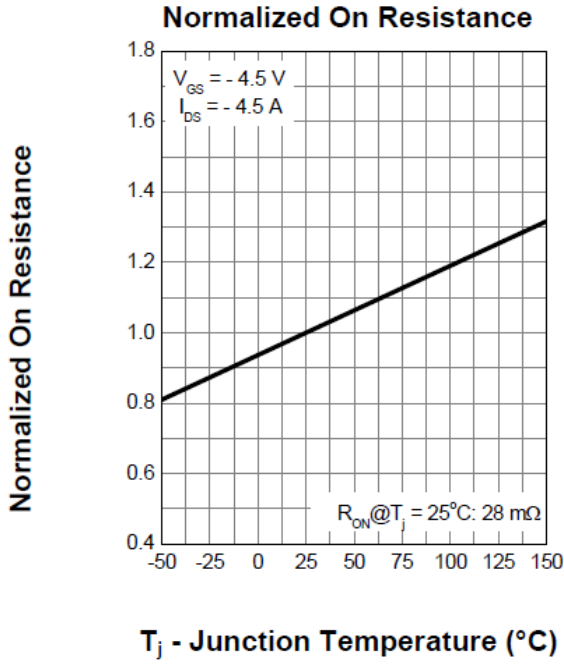

Packaging Information

SOP-8 pin

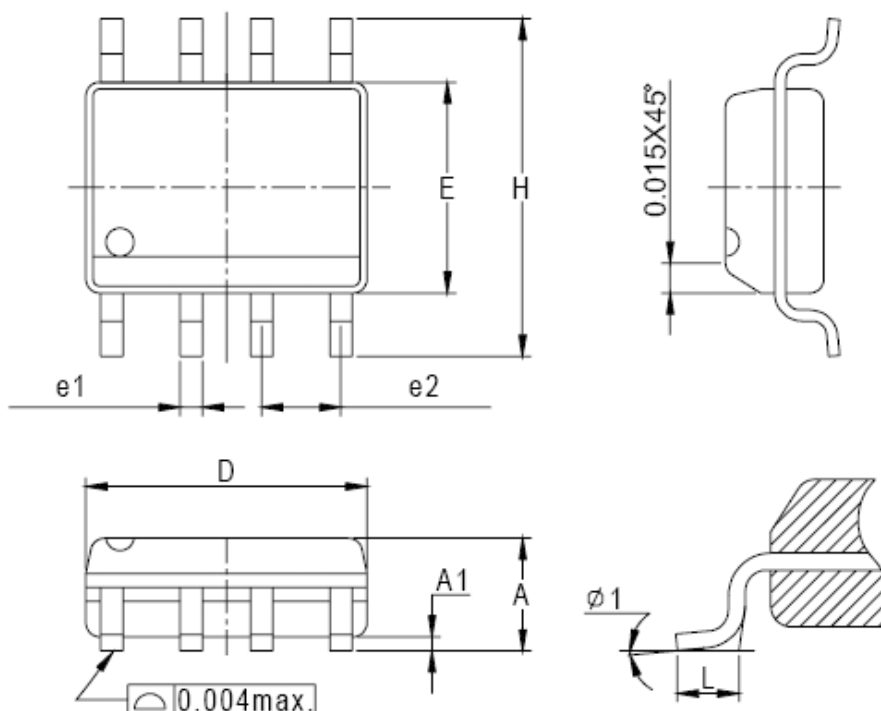

Dim	Millimeters		Inches	
	Min.	Max.	Min.	Max.
A	1.35	1.75	0.053	0.069
A1	0.10	0.25	0.004	0.010
D	4.80	5.00	0.189	0.197
E	3.80	4.00	0.150	0.157
H	5.80	6.20	0.228	0.244
L	0.40	1.27	0.016	0.050
e1	0.33	0.51	0.013	0.020
e2	1.27BSC		0.50BSC	
φ 1	8°		8°	

The SINO-IC logo is a registered trademark of Shanghai Sino-IC Microelectronics Co., Ltd.

© 2005 SINO-IC – Printed in China – All rights reserved.

SHANGHAI SINO-IC MICROELECTRONICS CO., LTD

Add: Building 3, Room 3401-03, No.200 Zhangheng Road, ZhangJiang Hi-Tech Park, Pudong, Shanghai 201203, China

Phone: +86-21-33932402 33932403 33932405 33933508 33933608

Fax: +86-21-33932401

Email: webmaster@sino-ic.com

Website: <http://www.sino-ic.com>

Shanghai Sino-IC Microelectronics Co., Ltd.