

## N-CHANNEL MOSFET

### 主要参数 MAIN CHARACTERISTICS

|                               |              |
|-------------------------------|--------------|
| $I_D$                         | 4A           |
| $V_{DSS}$                     | 650V         |
| $R_{DS(ON)}$ ( $V_{GS}=10V$ ) | 2.6 $\Omega$ |
| $Q_G$                         | 18nC         |

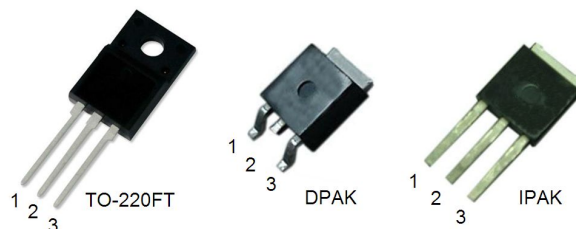

### 用途

- 高频开关电源
- 电子整流器
- LED 电源

### APPLICATIONS

- High efficiency switch mode power supplies
- Electronic lamp ballasts based on half bridge
- LED power supplies

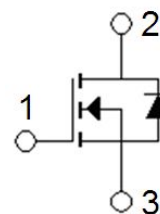

### 产品特性

- 低栅极电荷
- 低  $C_{RSS}$  (典型值 50pF)
- 开关速度快
- 100%雪崩测试
- 高抗 dv/dt 能力
- RoHS 产品

### FEATURES

- Low gate charge
- Low  $C_{RSS}$ (typical 50pF)
- Fast switching
- 100% avalanche tested
- Improved dv/dt capability
- RoHS product

1 Gate  
2 Drain  
3 Source

### 订货信息 ORDER MESSAGE

| 订货型号<br>Order codes | 印记<br>Marking | 封装<br>Package | 无卤素<br>Halogen Free | 包装<br>Packaging | 器件重量<br>Device Weight |
|---------------------|---------------|---------------|---------------------|-----------------|-----------------------|
| SL4N65F             | SL4N65F       | TO-220FT      | 否 NO                | 条管 Tube         | 2.2g(typ)             |
| SL4N65I             | SL4N65I       | IPAK          | 否 NO                | 条管 Tube         | 0.35g(typ)            |
| SL4N65D             | SL4N65D       | DPAK          | 否 NO                | 条管 Tube         | 0.3g(typ)             |

## 绝对值 ABSOLUTE RATINGS ( $T_C=25^{\circ}\text{C}$ , unless otherwise specified)

| 项目<br>Parameter   | 符号<br>Symbol | 数值<br>Ratings                     |      |          | 单位<br>Unit            |
|---|--------------|-----------------------------------|------|----------|-----------------------|
|   |              | IPAK                              | DPAK | TO-220FT |                       |
| 漏极-源极击穿电压<br>Drain-Source Breakdown Voltage                 | $V_{DSS}$    | 650                               |      |          | V                     |
| 漏极连续电流<br>Continuous Drain Current                          | $I_D$        | $T_C=25^{\circ}\text{C}$          |      |          | A                     |
|   |              | $T_C=100^{\circ}\text{C}$         |      |          | A                     |
| 漏极脉冲电流 (注 1)<br>Drain Current pulsed (note 1)               | $I_{DM}$     | 16*                               |      |          | A                     |
| 最高栅源电压<br>Gate-Source Voltage                               | $V_{GSS}$    | $\pm 30$                          |      |          | V                     |
| 单脉冲雪崩能量 (注 2)<br>Single Pulsed Avalanche Energy (note 2)    | $E_{AS}$     | 184                               |      |          | mJ                    |
| 重复雪崩能量 (注 1)<br>Repetitive Avalanche Current (note 1)       | $E_{AR}$     | 15                                |      |          | mJ                    |
| 二极管反向恢复最大电压变化速率 (注 3)<br>Peak Diode Recovery dv/dt (note 3) | dv/dt        | 5                                 |      |          | V/ns                  |
| 耗散功率<br>Total Power Dissipation                             | $P_D$        | $T_C=25^{\circ}\text{C}$          |      |          | W                     |
|   |              | Derate above $25^{\circ}\text{C}$ |      |          | W/ $^{\circ}\text{C}$ |
| 最高结温<br>Operating Junction Temperature                      | $T_J$        | 150                               |      |          | $^{\circ}\text{C}$    |
| 存储温度<br>Storage Temperature                                 | $T_{STG}$    | -55~+150                          |      |          | $^{\circ}\text{C}$    |
| 焊接温度<br>Maximum Temperature for Soldering Leads             | $T_L$        | 300                               |      |          | $^{\circ}\text{C}$    |

\* 漏极电流由最高结温限制。

\* Drain current is limited by junction temperature.

## 电特性 ELECTRICAL CHARACTERISTICS ( $T_J=25^{\circ}\text{C}$ , unless otherwise specified)

| 项目<br>Parameter                                       | 符号<br>Symbol                 | 测试条件<br>Test conditions                                      | 最小值<br>Min                             | 典型值<br>Typ | 最大值<br>Max | 单位<br>Unit            |    |
|---|------------------------------|--|--|------------|------------|-----------------------|----|
| <b>断态特性 Off Characteristics</b>                       |                              |  |  |            |            |                       |    |
| 漏-源击穿电压<br>Drain-Source Breakdown Voltage             | $BV_{DSS}$                   | $I_D=250\mu\text{A}, V_{GS}=0\text{V}$                       | 650                                    | -          | -          | V                     |    |
| 击穿电压温度特性<br>Breakdown Voltage Temperature Coefficient | $\Delta BV_{DSS}/\Delta T_J$ | $I_D=250\mu\text{A}$ ,<br>referenced to $25^{\circ}\text{C}$ | -                                      | 0.48       | -          | V/ $^{\circ}\text{C}$ |    |
| 漏源极漏电流<br>Drain-Source leakage Current                | $I_{DSS}$                    | $V_{DS}=650\text{V}, V_{GS}=0\text{V}$                       | -                                      | -          | 1          | $\mu\text{A}$         |    |
|   |                              | $V_{DS}=520\text{V}, T_C=125^{\circ}\text{C}$                | -                                      | -          | 50         | $\mu\text{A}$         |    |
| 栅源极漏电流<br>Gate-Source leakage current                 | 正向 Forward                   | $I_{GSS}$  | $V_{DS}=0\text{V}, V_{GS}=30\text{V}$  | -          | -          | 100                   | nA |
|   | 反向 Reverse                   |  | $V_{DS}=0\text{V}, V_{GS}=-30\text{V}$ | -          | -          | -100                  | nA |

| 项目<br>Parameter                                    | 符号<br>Symbol | 测试条件<br>Test conditions                                  | 最小值<br>Min | 典型值<br>Typ | 最大值<br>Max | 单位<br>Unit |
|--|--------------|--|------------|------------|------------|------------|
| <b>通态特性 On Characteristics</b>                     |              |  |            |            |            |            |
| 阈值电压<br>Gate Threshold Voltage                     | $V_{GS(th)}$ | $V_{DS}=V_{GS}, I_D=250\mu A$                            | 2.5        | -          | 4.5        | V          |
| 静态导通电阻<br>Static Drain-Source On-Resistance        | $R_{DS(on)}$ | $V_{GS}=10V, I_D=2A$                                     | -          | 2          | 2.6        | $\Omega$   |
| 正向跨导<br>Forward Transconductance                   | $g_{FS}$     | $V_{DS}=30V, I_D=2A$ (note 4)                            | 3.5        | -          | -          | S          |
| <b>动态特性 Dynamic Characteristics</b>                |              |  |            |            |            |            |
| 输入电容<br>Input capacitance                          | $C_{ISS}$    | $V_{DS}=25V, V_{GS}=0V,$<br>$f=1MHz$                     | -          | 531        | -          | pF         |
| 输出电容<br>Output capacitance                         | $C_{OSS}$    |  | -          | 60         | -          |            |
| 反向传输电容<br>Reverse transfer capacitance             | $C_{RSS}$    |  | -          | 50         | -          |            |
| <b>开关特性 Switching Characteristics</b>              |              |  |            |            |            |            |
| 导通延迟时间<br>Turn on delay time                       | $t_{d(on)}$  | $V_{DD}=325V, I_D=4A,$<br>$R_G=25\Omega$<br>(note 4, 5)  | -          | 11         | -          | ns         |
| 上升时间<br>Rise time                                  | $t_r$        |  | -          | 26         | -          |            |
| 关断延迟时间<br>Turn off delay time                      | $t_{d(off)}$ |  | -          | 42         | -          |            |
| 下降时间<br>Fall time                                  | $t_f$        |  | -          | 27         | -          |            |
| 栅极电荷总量<br>Total Gate Charge                        | $Q_G$        | $V_{DS}=520V, I_D=4A,$<br>$V_{GS}=10V$<br>(note 4, 5)    | -          | 18         | -          | nC         |
| 栅-源电荷<br>Gate-Source charge                        | $Q_{GS}$     |  | -          | 3          | -          |            |
| 栅-漏电荷<br>Gate-Drain charge                         | $Q_{GD}$     |  | -          | 9          | -          |            |
| <b>源-漏二极管特性 Source-Drain Diode Characteristics</b> |              |  |            |            |            |            |
| 正向连续电流<br>Continuous Forward Current               | $I_S$        |  | -          | -          | 4          | A          |
| 正向脉冲电流<br>Pulsed Forward Current                   | $I_{SM}$     |  | -          | -          | 16         | A          |
| 正向压降<br>Forward Voltage                            | $V_{SD}$     | $V_{GS}=0V, I_S=4A$                                      | -          | -          | 1.5        | V          |
| 反向恢复时间<br>Reverse recovery time                    | $t_{rr}$     | $V_{GS}=0V, I_S=4A,$<br>$di_F/dt=100A/\mu s$<br>(note 4) | -          | 229        | -          | ns         |
| 反向恢复电荷<br>Reverse recovery charge                  | $Q_{rr}$     |  | -          | 1.6        | -          | $\mu C$    |

## 热特性 THERMAL CHARACTERISTICS

| 项目<br>Parameter                                    | 符号<br>Symbol  | 最大值<br>Max |      |          | 单位<br>Unit |
|--|---------------|------------|------|----------|------------|
|  |               | IPAK       | DPAK | TO-220FT |            |
| 结到管壳的热阻<br>Thermal Resistance, Junction to Case    | $R_{th(j-c)}$ | 0.8        | 0.87 | 5.36     | °C/W       |
| 结到环境的热阻<br>Thermal Resistance, Junction to Ambient | $R_{th(j-a)}$ | 81.4       | 79.6 | 48.7     | °C/W       |

注:

- 1: 脉冲宽度由最高结温限制
- 2:  $L=22.8\text{mH}$ ,  $I_{AS}=4\text{A}$ ,  $V_{DD}=50\text{V}$ ,  $R_G=25\Omega$ , 起始结温  $T_J=25^\circ\text{C}$
- 3:  $I_{SD}\leq 4\text{A}$ ,  $di/dt \leq 100\text{A}/\mu\text{s}$ ,  $V_{DD}\leq BV_{DSS}$ , 起始结温  $T_J=25^\circ\text{C}$
- 4: 脉冲测试: 脉冲宽度  $\leq 300\mu\text{s}$ , 占空比  $\leq 2\%$
- 5: 基本与工作温度无关

Notes:

- 1: Pulse width limited by maximum junction temperature
- 2:  $L=22.8\text{mH}$ ,  $I_{AS}=4\text{A}$ ,  $V_{DD}=50\text{V}$ ,  $R_G=25\Omega$ , Starting  $T_J=25^\circ\text{C}$
- 3:  $I_{SD}\leq 4\text{A}$ ,  $di/dt \leq 100\text{A}/\mu\text{s}$ ,  $V_{DD}\leq BV_{DSS}$ , Starting  $T_J=25^\circ\text{C}$
- 4: Pulse Test: Pulse Width  $\leq 300\mu\text{s}$ , Duty Cycle  $\leq 2\%$
- 5: Essentially independent of operating temperature

## 特征曲线 TYPICAL CHARACTERISTICS (curves)

Fig.1. On-state Characteristics

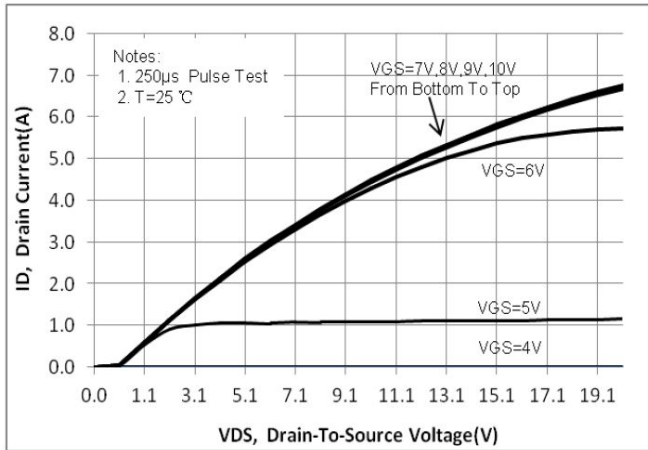

Fig.2. On-resistance variation vs. drain current and gate voltage

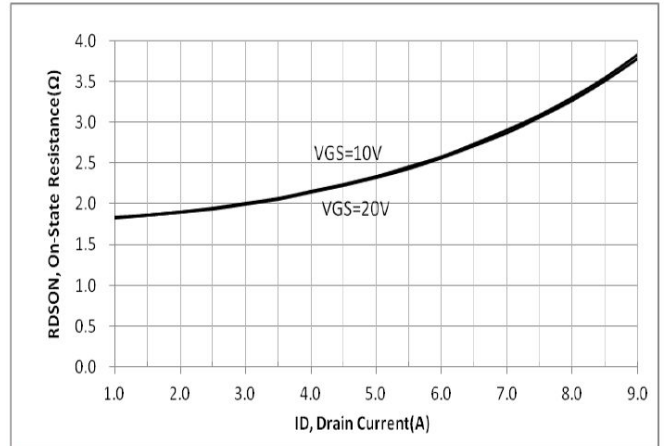

Fig.3. Gate charge characteristics

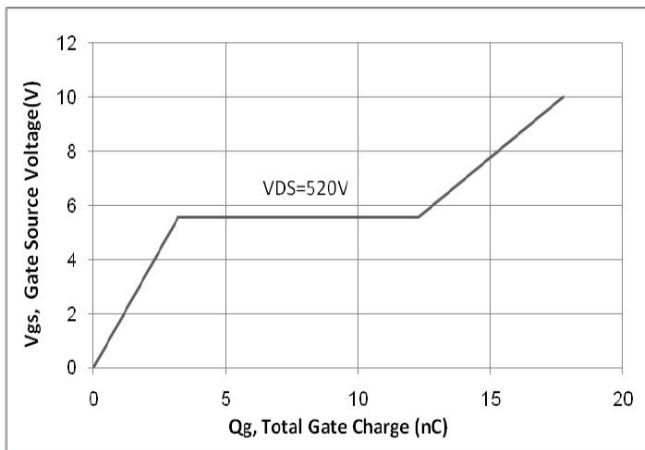

Fig.4. On state current vs. Diode forward voltage

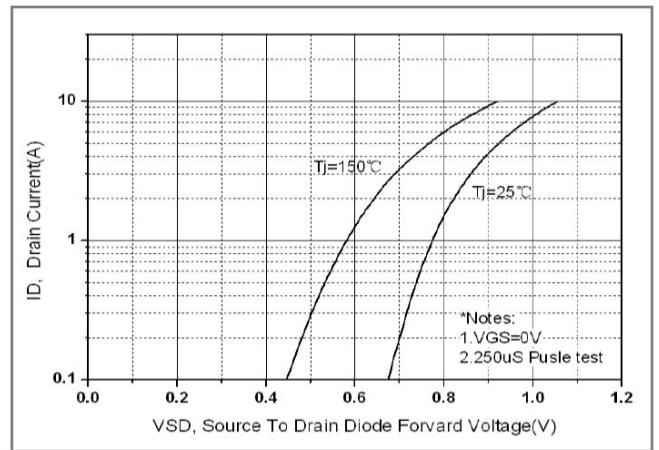

Fig.5. Breakdown voltage variation vs. Junction temperature

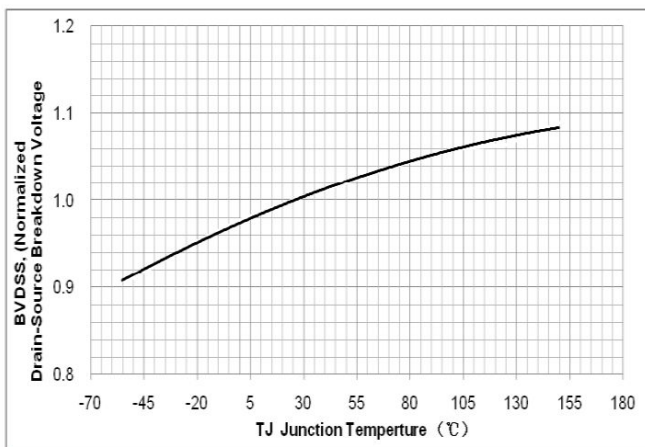

Fig.6. On resistance variation vs. Junction temperature

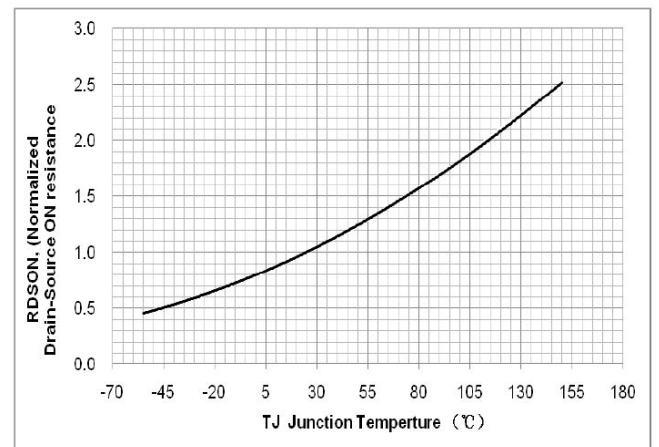

Fig.7. Maximum safe operating area(TO-220FT)

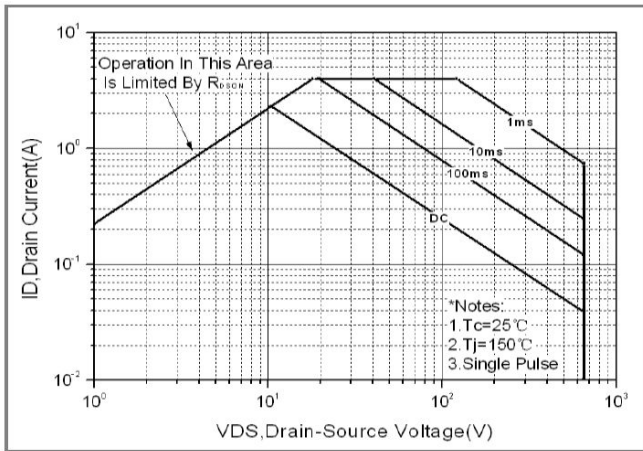

Fig.8. Transient thermal response curve(TO-220FT)

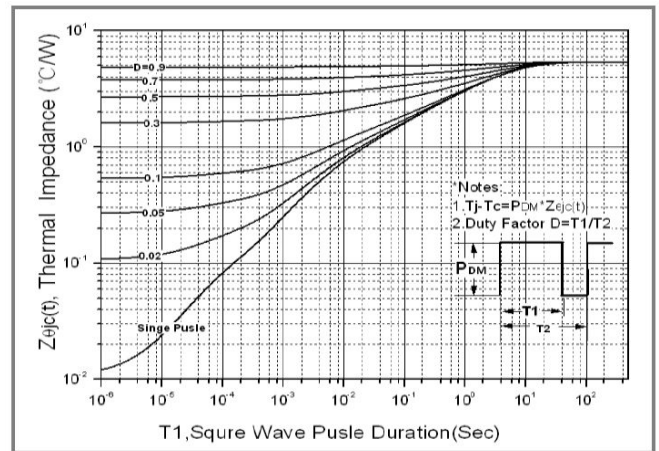

Fig.9. Maximum safe operating area(IPAK)

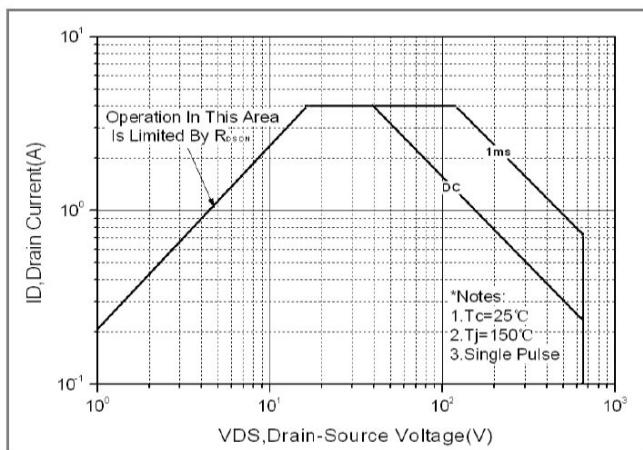

Fig.10. Transient thermal response curve(IPAK)

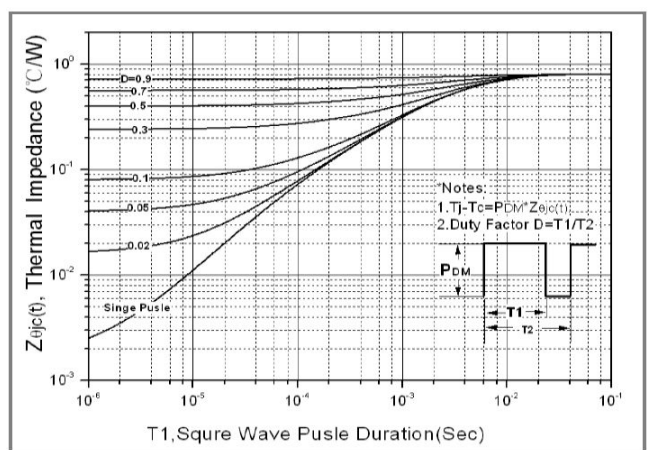

Fig.11. Maximum safe operating area(DPAK)

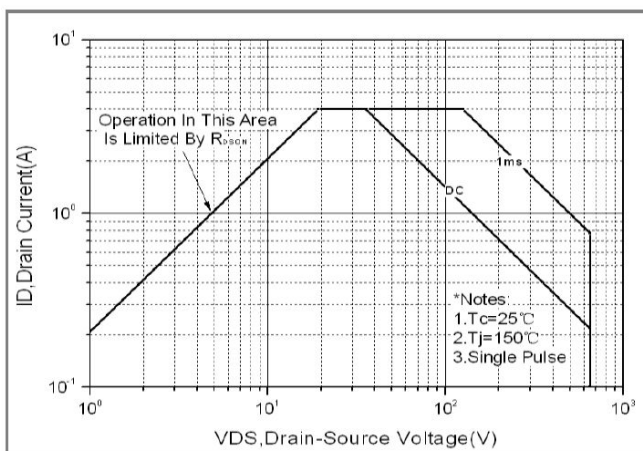

Fig.12. Transient thermal response curve(DPAK)

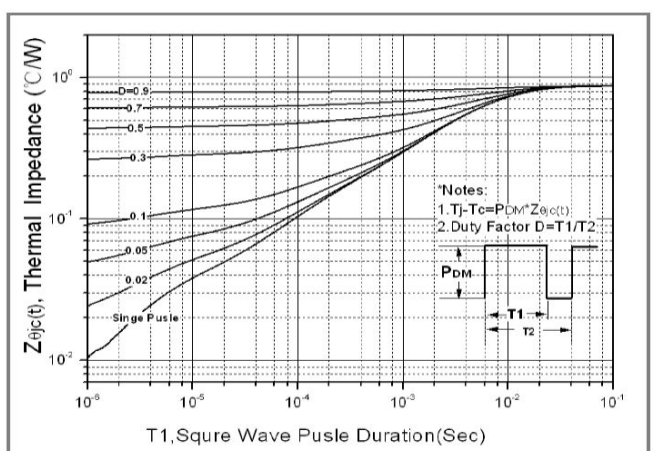

Fig.13. Capacitance characteristics

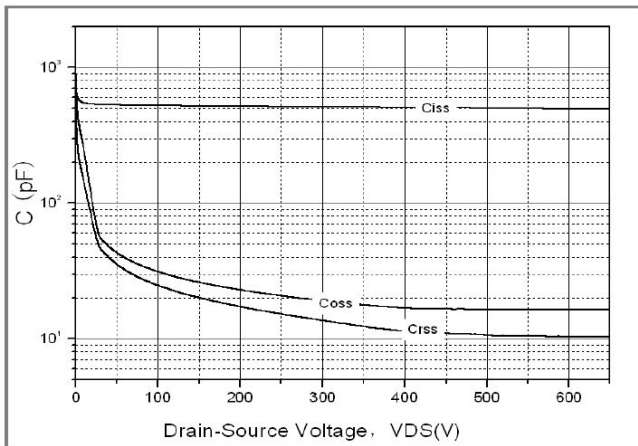

Fig.14. Gate charge test circuit & waveform

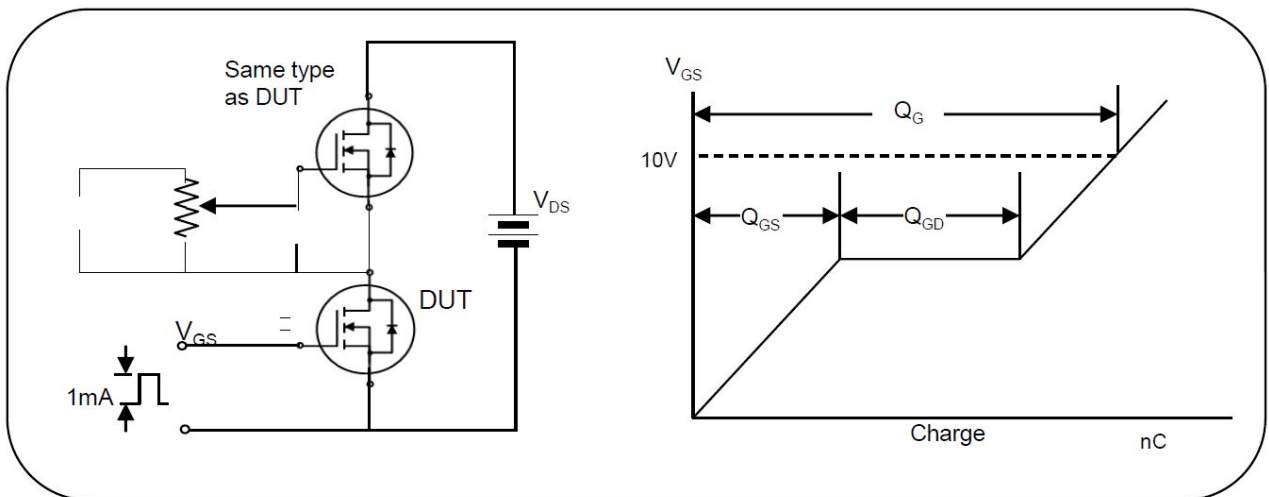

Fig.15. Switching time test circuit & waveform

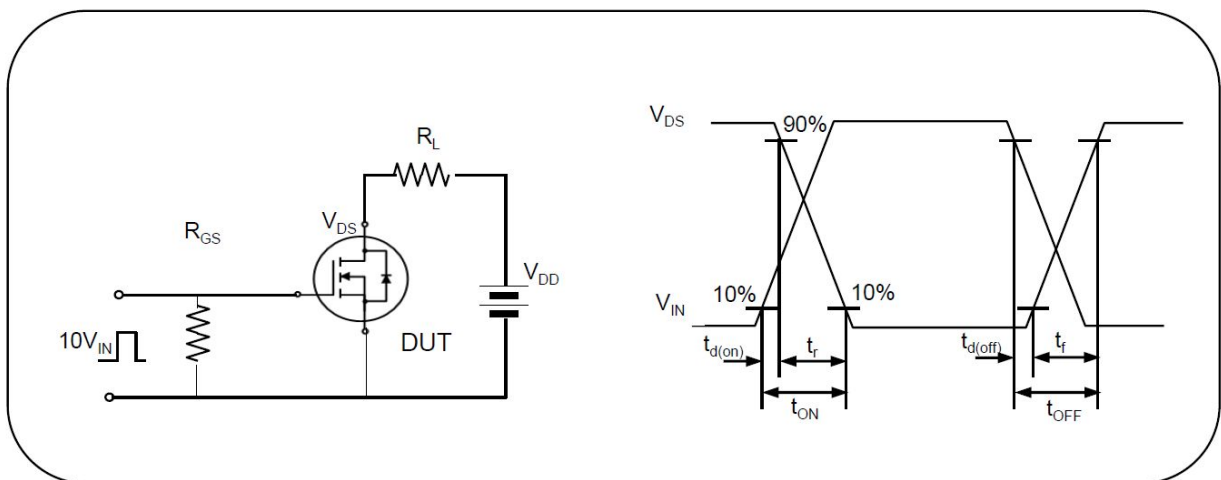

Fig.16. Unclamped inductive switching test circuit & waveform

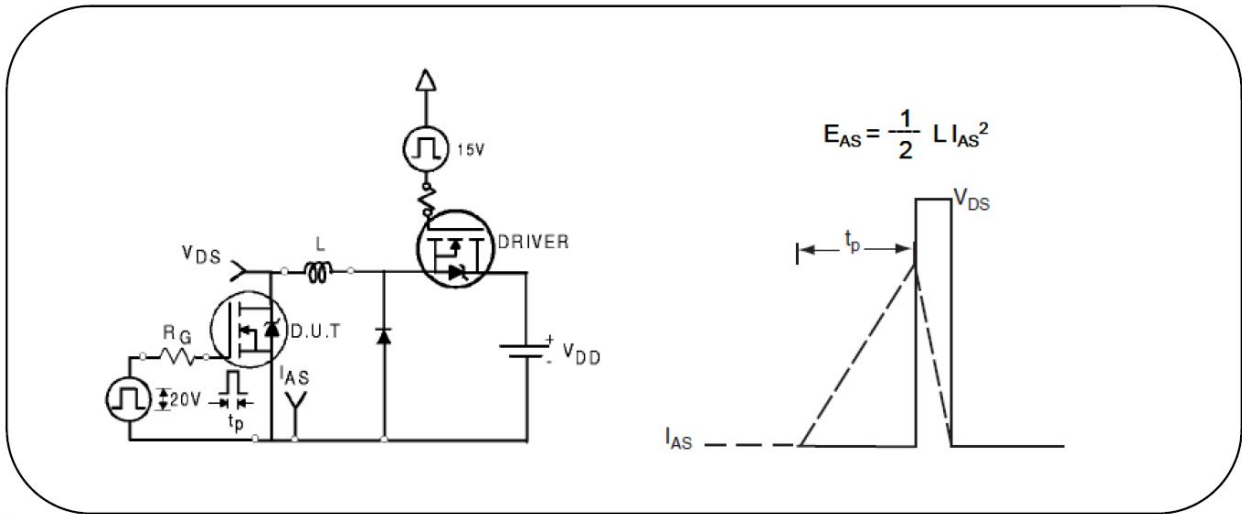
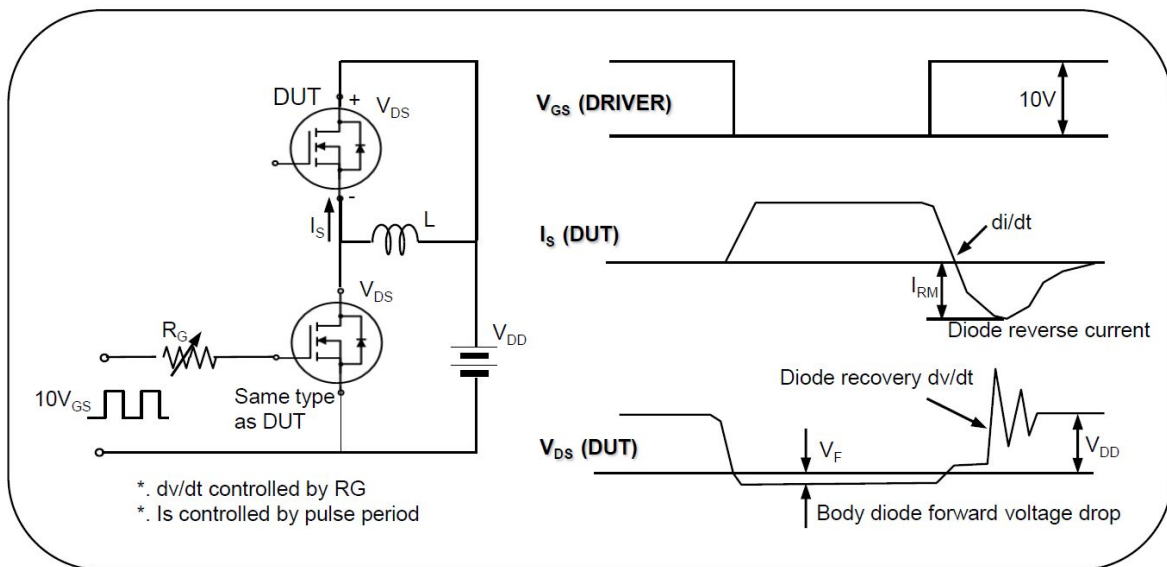

Fig.17. Peak diode recovery dv/dt test circuit & waveform





## 外形尺寸 PACKAGE MECHANICAL DATA

### TO-220FT

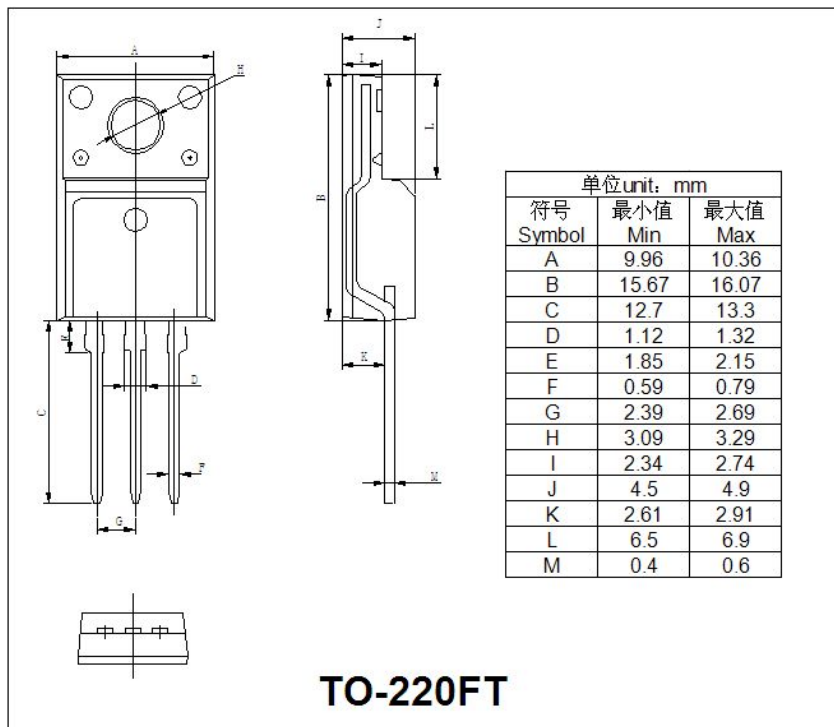

### IPAK

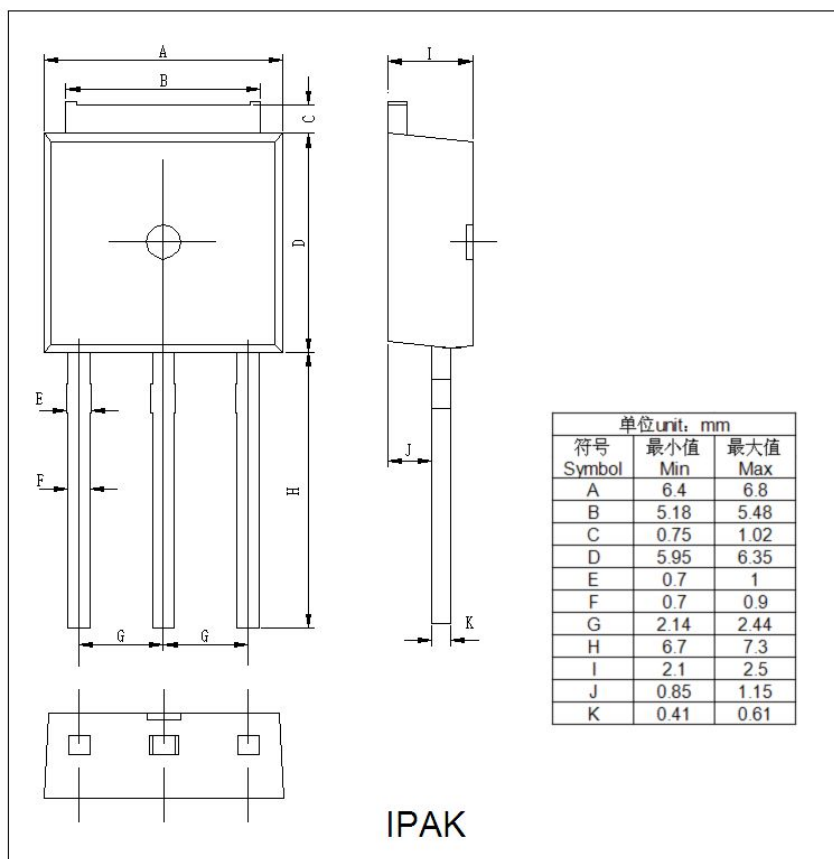

## DPAK

