

SE12N65

**N-Channel Enhancement-Mode MOSFET**

Revision: A

**General Description**

Thigh Density Cell Design For Ultra Low On-Resistance Fully Characterized Avalanche Voltage and Current Improved Shoot-Through FOM

- Simple Drive Requirement
- Small Package Outline
- Surface Mount Device

**Features**

For a single MOSFET

- $V_{DS} = 650V$
- $R_{DS(ON)} = 630m\Omega @ V_{GS}=10V$

**Pin configurations**

See Diagram below

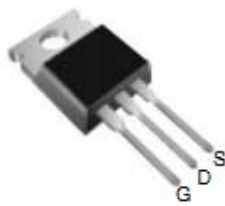

TO-220



TO-220F

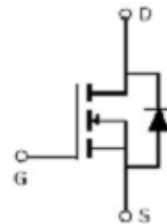

**Absolute Maximum Ratings**

Parameter		Symbol	Rating	Units
Drain-Source Voltage		$V_{DS}$	650	V
Gate-Source Voltage		$V_{GS}$	$\pm 30$	V
Drain Current	Continuous	$I_D$	12	A
	Pulsed		28	
Single Pulse Avalanche Engergy		$E_{AS}$	226	mJ
Total Power Dissipation	@TA=25°C	$P_D$	156	W
Operating Junction Temperature Range		$T_J$	-55 to 150	°C

## SE12N65

Electrical Characteristics (T <sub>J</sub> =25°C unless otherwise noted)						
Symbol	Parameter	Test Conditions	Min	Typ	Max	Units
<b>OFF CHARACTERISTICS (Note 2)</b>						
B <sub>V</sub> DSS	Drain-Source Breakdown Voltage	I <sub>D</sub> =250μA, V <sub>GS</sub> =0 V	650			V
I <sub>DSS</sub>	Drain to Source Leakage Current	V <sub>DS</sub> = 650V, V <sub>GS</sub> =0V			1	μA
I <sub>GSS</sub>	Gate-Body Leakage Current	V <sub>GS</sub> =20 V			100	nA
V <sub>GS(th)</sub>	Gate Threshold Voltage	V <sub>DS</sub> = V <sub>GS</sub> , I <sub>D</sub> =250μA	2		4	V
R <sub>DS(ON)</sub>	Static Drain-Source On-Resistance <sup>2</sup>	V <sub>GS</sub> =10V, I <sub>D</sub> =6A		630	750	mΩ
g <sub>fs</sub>	Forward Transconductance	V <sub>DS</sub> =30V, I <sub>D</sub> =6A		3.5		S
<b>DYNAMIC PARAMETERS</b>						
C <sub>iss</sub>	Input Capacitance	V <sub>GS</sub> =0V, V <sub>DS</sub> =100V, f=1MHz		1224		pF
C <sub>oss</sub>	Output Capacitance			65		pF
C <sub>rss</sub>	Reverse Transfer Capacitance			4		pF
<b>SWITCHING PARAMETERS</b>						
Q <sub>g</sub>	Total Gate Charge <sup>2</sup>	V <sub>GS</sub> =10V, V <sub>DS</sub> =520V, I <sub>D</sub> =6A		35	70	nC
Q <sub>gs</sub>	Gate Source Charge			9		nC
Q <sub>gd</sub>	Gate Drain Charge			16		nC
t <sub>d(on)</sub>	Turn-On Delay Time	V <sub>GS</sub> =10V, V <sub>DS</sub> =520V, R <sub>GEN</sub> =9.1Ω I <sub>D</sub> =6A		16	32	ns
t <sub>d(off)</sub>	Turn-Off Delay Time			35	70	ns
t <sub>d(r)</sub>	Turn-On Rise Time			19	38	ns
t <sub>d(f)</sub>	Turn-Off Fall Time			18	36	ns
<b>Thermal Resistance</b>						
Symbol	Parameter		Typ	Max	Units	
R <sub>θJC</sub>	Junction to Case		-	0.8	°C/W	
R <sub>θJA</sub>	Junction to Ambient (t ≤ 10s)		-	62	°C/W	

Typical Characteristics

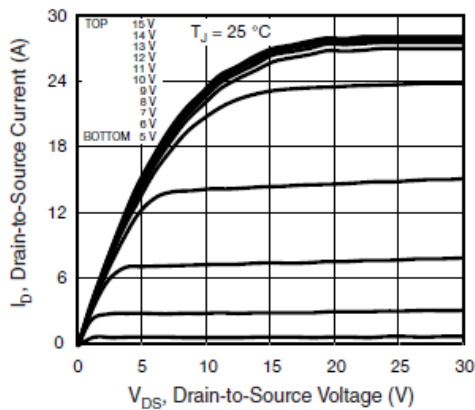

Fig. 1 - Typical Output Characteristics

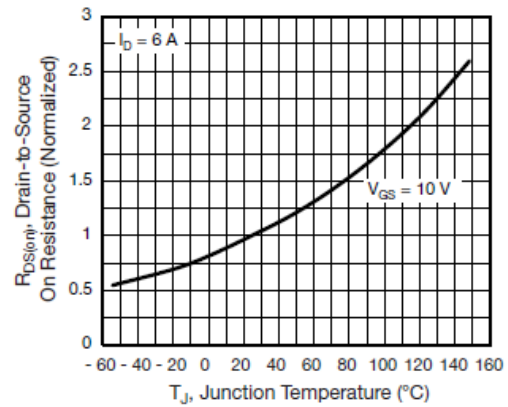

Fig. 4 - Normalized On-Resistance vs. Temperature

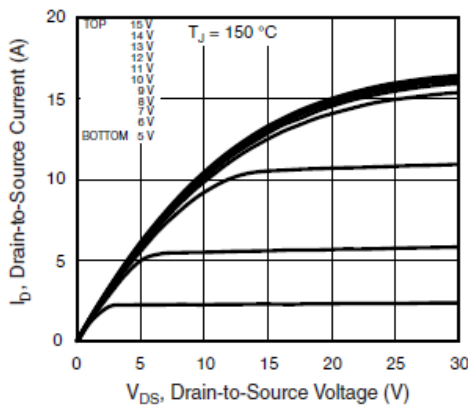

Fig. 2 - Typical Output Characteristics

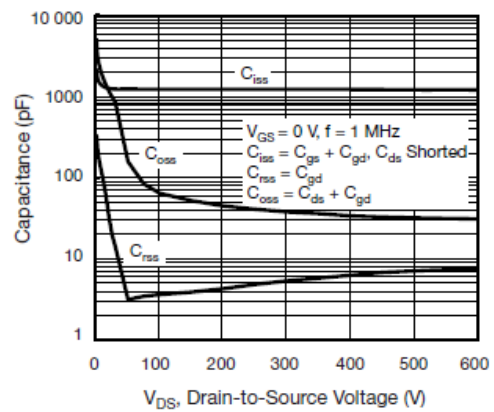

Fig. 5 - Typical Capacitance vs. Drain-to-Source Voltage

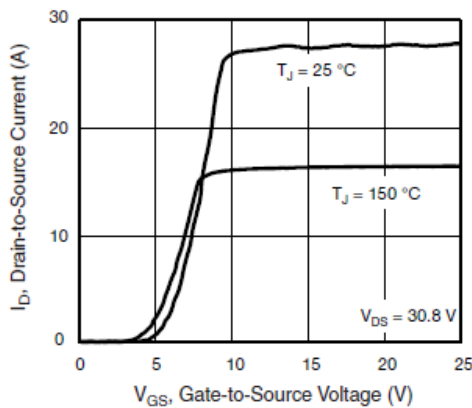

Fig. 3 - Typical Transfer Characteristics

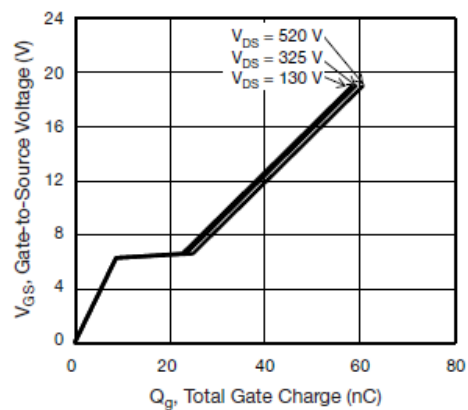

Fig. 6 - Typical Gate Charge vs. Gate-to-Source Voltage

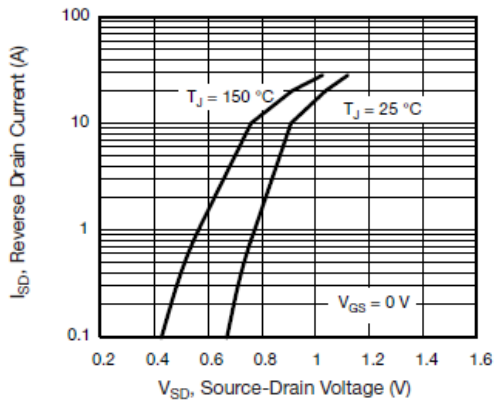

Fig. 7 - Typical Source-Drain Diode Forward Voltage

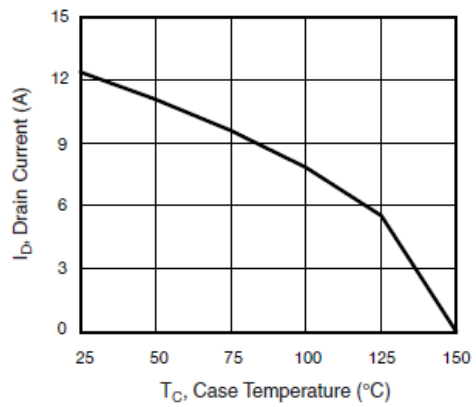

Fig. 9 - Maximum Drain Current vs. Case Temperature

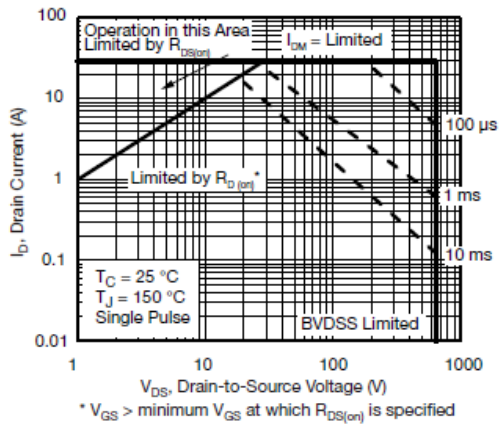

Fig. 8 - Maximum Safe Operating Area

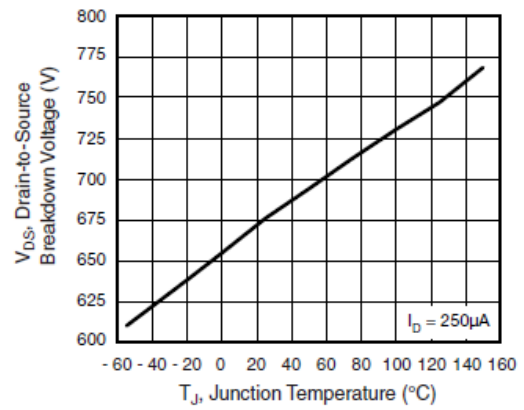

Fig. 10 - Temperature vs. Drain-to-Source Voltage

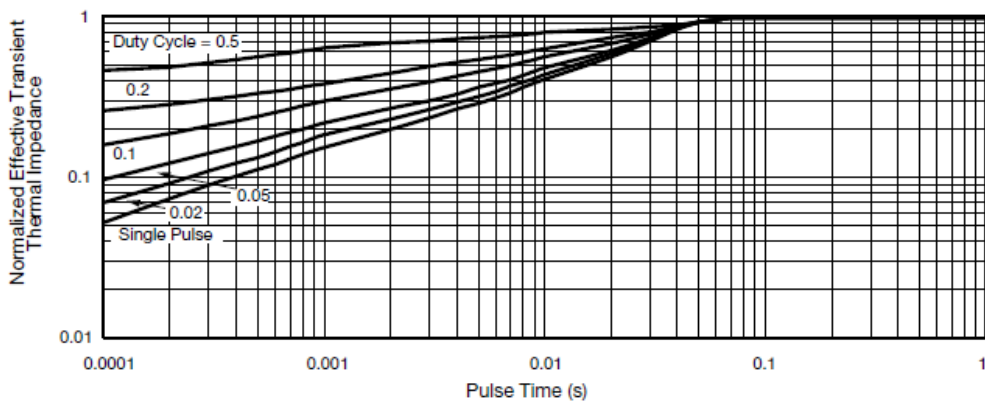
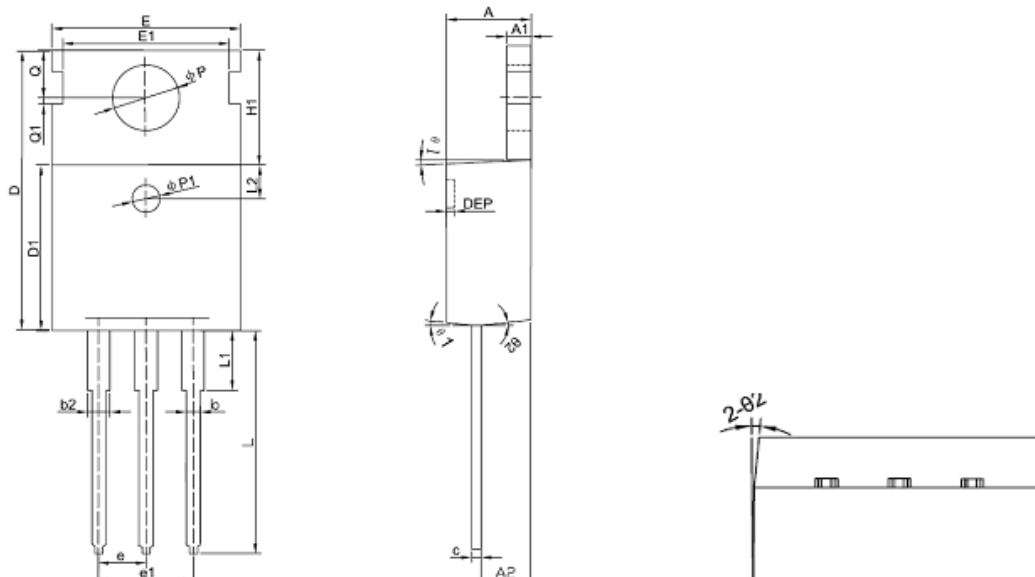

Fig. 11 - Normalized Thermal Transient Impedance, Junction-to-Case

# SE12N65

## Package Outline Dimension

TO-220



Symbol	Dimension In Millimeters			Dimension In Inches		
	Min	Nom	Max	Min	Nom	Max
A	4.400	4.550	4.700	0.173	0.179	0.185
A1	1.270	1.300	1.330	0.050	0.051	0.052
A2	2.590	2.690	2.790	0.102	0.106	0.110
b	0.770	-	0.900	0.030	-	0.035
b2	1.230	-	1.360	0.048	-	0.054
c	0.480	0.500	0.520	0.019	0.020	0.020
D	15.100	15.400	15.700	-	0.606	-
D1	9.000	9.100	9.200	0.354	0.358	0.362
DEP	0.050	0.285	0.520	0.002	0.011	0.020
E	10.060	10.160	10.260	0.396	0.400	0.404
E1	-	8.700	-	-	0.343	-
ΦP1	1.400	1.500	1.600	0.055	0.059	0.063
e	2.54BSC			0.1BSC		
e1	5.08BSC			0.2BSC		
H1	6.100	6.300	6.500	0.240	0.248	0.256
L	12.750	12.960	13.170	0.502	0.510	0.519
L1	-	-	3.950	-	-	0.156
L2	1.85REF			0.073REF		
ΦP	3.570	3.600	3.630	0.141	0.142	0.143
Q	2.730	2.800	2.870	0.107	0.110	0.113
Q1	-	0.200	-	-	0.008	-
θ1	5 <sup>0</sup>	7 <sup>0</sup>	9 <sup>0</sup>	5 <sup>0</sup>	7 <sup>0</sup>	9 <sup>0</sup>
θ2	1 <sup>0</sup>	3 <sup>0</sup>	5 <sup>0</sup>	1 <sup>0</sup>	3 <sup>0</sup>	5 <sup>0</sup>

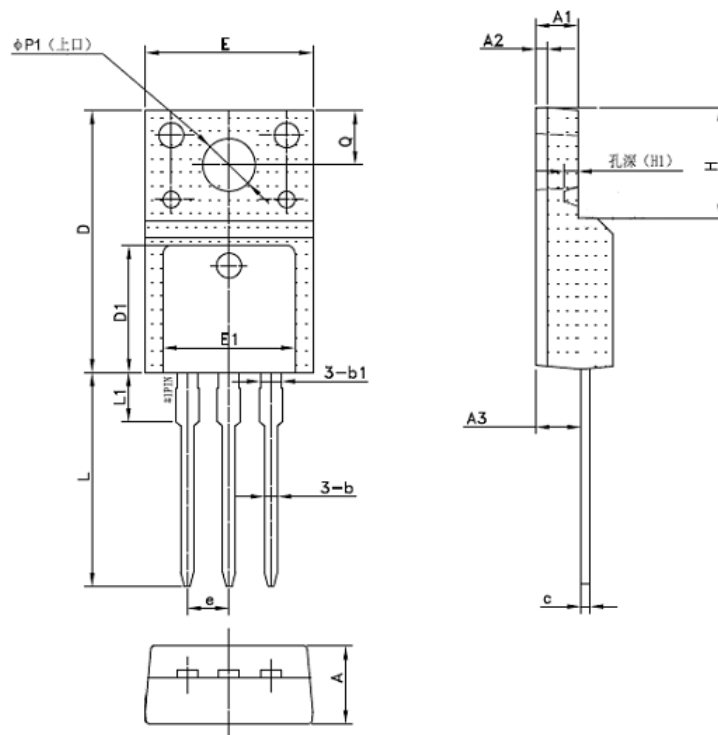

Symbol	Dimensions(mm)		
	Min.	Typ.	Max.
A	4.50	4.70	4.90
A1	2.44	2.54	2.64
A2	0.60	0.70	0.80
A3	2.56	2.76	2.96
b	0.70	0.80	0.95
b1	-	1.28	-
c	0.45	0.50	0.65
D	15.67	15.87	16.07
D1	-	7.70	-
E	9.96	10.16	10.36
E1	-	8.00	-
e	2.54(BSC)		
H	6.50	6.70	6.90
(H1)	-	(0.81)	-
L	12.48	12.98	13.20
L1	-	2.93	-
$\phi P1$	2.98	3.18	3.38
Q	3.10	3.30	3.50

The SINO-IC logo is a registered trademark of ShangHai Sino-IC Microelectronics Co., Ltd.

© 2005 SINO-IC - Printed in China - All rights reserved.

SHANGHAI SINO-IC MICROELECTRONICS CO., LTD

Add: Building 3, Room 3401-03, No.200 Zhangheng Road,  
ZhangJiang Hi-Tech Park, Pudong, Shanghai 201203, China

Phone: +86-21-33932402 33932403

33932405 33933508 33933608

Fax: +86-21-33932401

Email: [webmaster@sino-ic.com](mailto:webmaster@sino-ic.com)

Website: <http://www.sino-ic.com>