

SE4607

Complementary Enhancement Mode Field Effect Transistor

Revision: A

Features

- N-Channel
 $V_{DS} = 20V$
 $R_{DS(ON)} = 20m\Omega @ V_{GS}=4.5V,$
- P-Channel
 $V_{DS} = -20V$
 $R_{DS(ON)} = 100m\Omega @ V_{GS}=-4.5V$

Applications

- Power Management in Desktop or DC/DC LCD display Converters

Constructions

- Silicon epitaxial planer

PIN CONFIGURATION

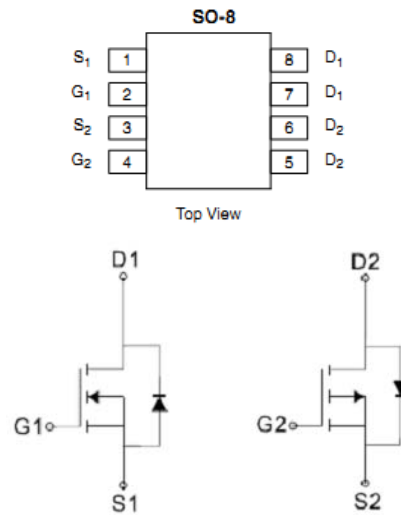

Absolute Maximum Ratings (TA=25°C)

Parameter	Symbol	Max N-channel	Max P-channel	Units
Drain-Source Voltage	V_{DS}	20	-20	V
Gate-Source Voltage	V_{GS}	± 8	± 8	V
Drain Current-Continuous@	I_D	4.2	-2.8	A
Current-Pulsed (Note 1)	I_{DM}	9	-9	
Total Power Dissipation	P_D	1.2	1.2	W
Operating Junction Temperature Range	T_J	-55 to 150		°C
Thermal Resistance				
Thermal Resistance Junction to Ambient (Note 2)	$R_{\theta JA}$	62.5	62.5	°C/W

N-Channel Electrical Characteristics (T_J=25°C unless otherwise noted)

Electrical Characteristics (T _J =25°C unless otherwise noted)						
Symbol	Parameter	Test Conditions	Min	Typ	Max	Units
OFF CHARACTERISTICS (Note 2)						
BV _{DSS}	Drain-Source Breakdown Voltage	I _D =250μA, V _{GS} =0 V	20			V
I _{DSS}	Drain to Source Leakage Current	V _{DS} = 20V, V _{GS} =0V			1	μA
I _{GSS}	Gate-Body Leakage Current	V _{GS} =± 8V, V _{DS} =0V			± 100	nA
V _{GS(th)}	Gate Threshold Voltage	V _{DS} = V _{GS} , I _D =250μA	0.6		1.2	V
R _{DS(ON)}	Static Drain-Source On-Resistance	V _{GS} =4.5V, I _D =2.8A		20	45	mΩ
DYNAMIC PARAMETERS						
C _{iss}	Input Capacitance	V _{GS} =0V, V _{DS} =10V, f=1MHz		450		pF
C _{oss}	Output Capacitance			70		pF
C _{rss}	Reverse Transfer Capacitance			43		pF
SWITCHING PARAMETERS						
Q _g	Total Gate Charge ²	V _{GS} =4.5V, V _{DS} =10V, I _D =3.6A		5.2	10	nC
Q _{gs}	Gate Source Charge			0.65		nC
Q _{gd}	Gate Drain Charge			1.5		nC
t _{d(on)}	Turn-On Delay Time	V _{GS} =4.5V, V _{DS} =10V, R _{GEN} =6Ω I _D =4.5A		7	15	ns
t _{d(off)}	Turn-Off Delay Time			16	60	ns
t _{d(r)}	Turn-On Rise Time			55	80	ns
t _{d(f)}	Turn-Off Fall Time			20	25	ns

P-Channel Electrical Characteristics (T_J=25°C unless otherwise noted)

Electrical Characteristics (T _J =25°C unless otherwise noted)						
Symbol	Parameter	Test Conditions	Min	Typ	Max	Units
OFF CHARACTERISTICS (Note 2)						
BV _{DSS}	Drain-Source Breakdown Voltage	I _D =-250μA, V _{GS} =0 V	-20			V
I _{DSS}	Drain to Source Leakage Current	V _{DS} = 20V, V _{GS} =0V			-1	μA
I _{GSS}	Gate-Body Leakage Current	V _{GS} =±10V, V _{DS} =0V			± 100	nA
V _{GS(th)}	Gate Threshold Voltage	V _{DS} = V _{GS} , I _D =-250μA	-0.45			V
R _{DS(ON)}	Static Drain-Source On-Resistance	V _{GS} =-4.5V, I _D =2.8A		100	150	mΩ
DYNAMIC PARAMETERS						
C _{iss}	Input Capacitance	V _{GS} =0V, V _{DS} =10V, f=1MHz		373		pF
C _{oss}	Output Capacitance			138		pF
C _{rss}	Reverse Transfer Capacitance			52		pF
SWITCHING PARAMETERS						
Q _g	Total Gate Charge ²	V _{GS} =-4.5V, V _{DS} =-6V, I _D =-2.8A		15.2		nC
Q _{gs}	Gate Source Charge			5.5		nC
Q _{gd}	Gate Drain Charge			2.7		nC
t _{d(on)}	Turn-On Delay Time	V _{GS} =-4.5V, V _{DS} =-6V, R _{GEN} =6Ω I _D =-1A			17.3	ns
t _{d(off)}	Turn-Off Delay Time				36.0	ns
t _{d(r)}	Turn-On Rise Time				3.7	ns
t _{d(f)}	Turn-Off Fall Time				3.2	ns

Typical Characteristics

N-CHANNEL TYPICAL ELECTRICAL AND THERMAL CHARACTERISTICS

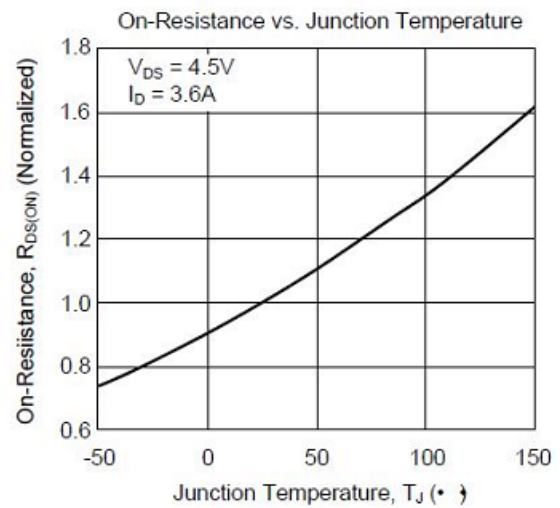
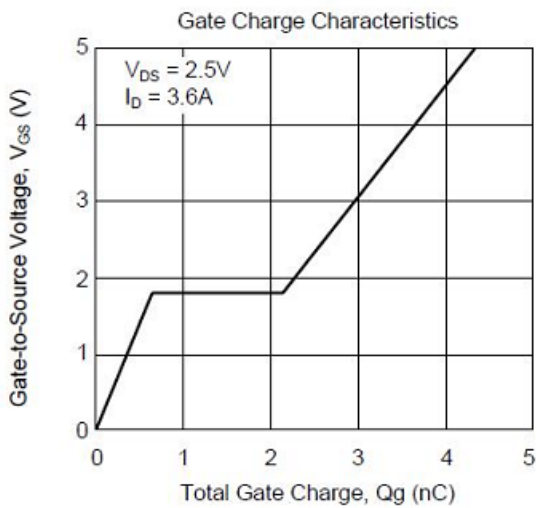
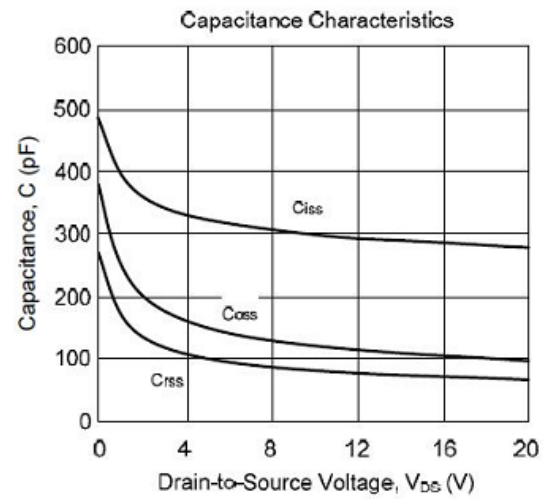
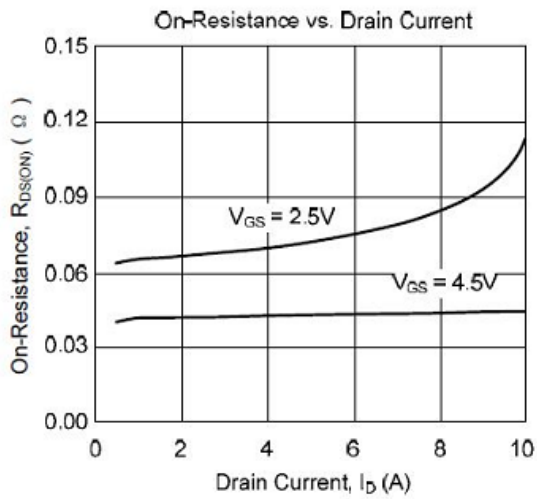
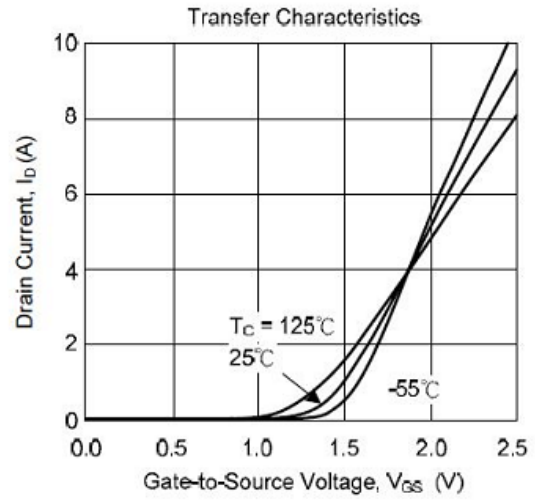
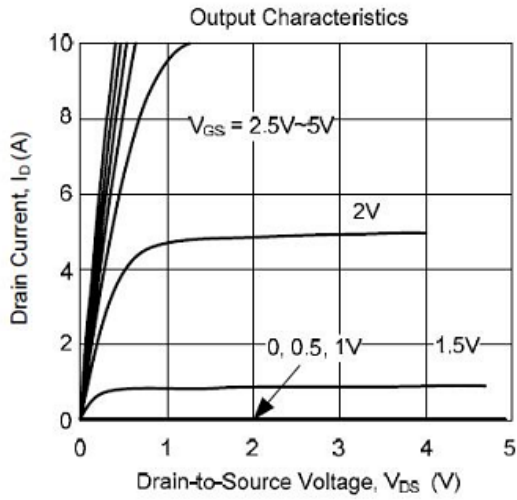

Typical Characteristics

N-CHANNEL TYPICAL ELECTRICAL AND THERMAL CHARACTERISTICS

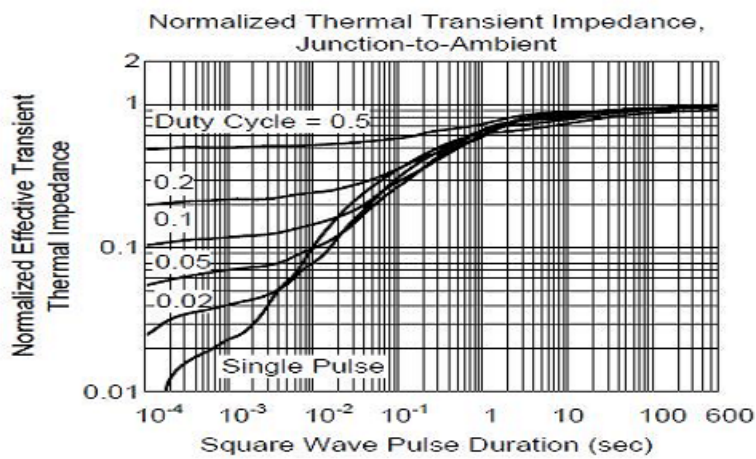
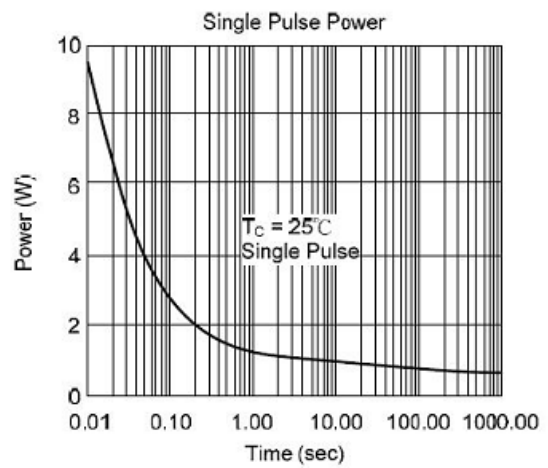
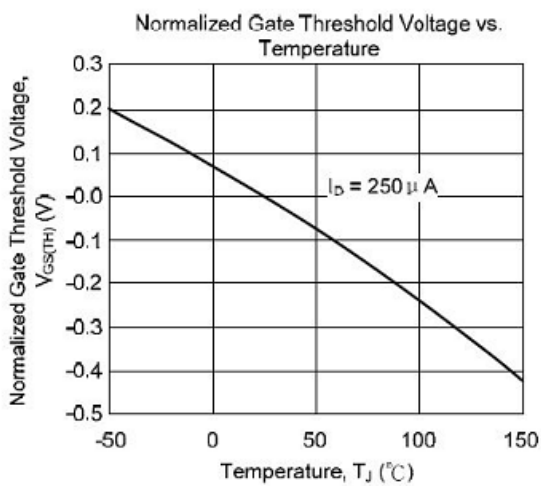
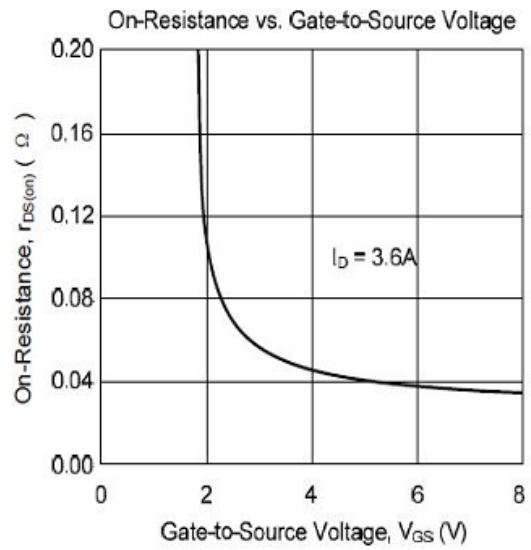
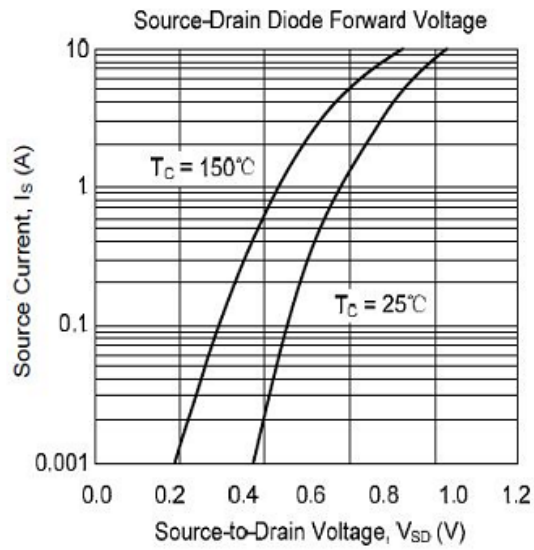

Typical Characteristics

P-CHANNEL TYPICAL ELECTRICAL AND THERMAL CHARACTERISTICS

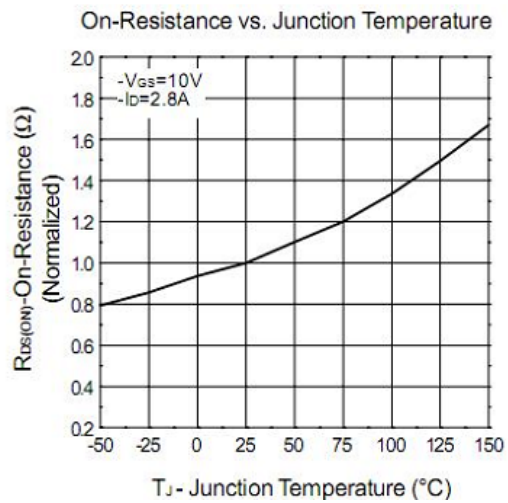
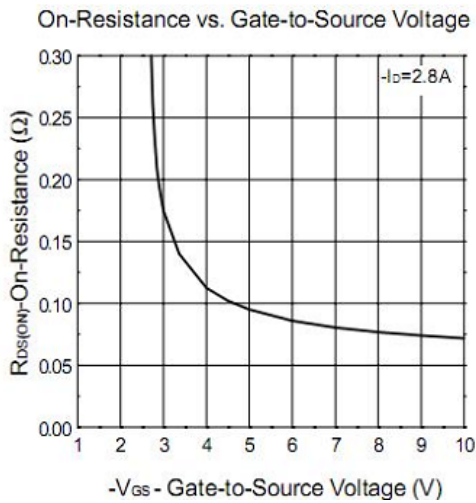
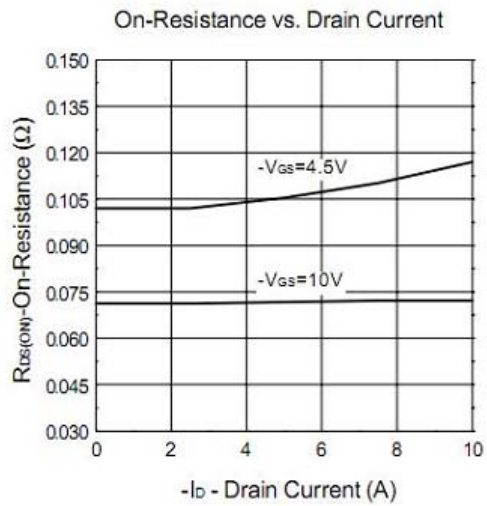
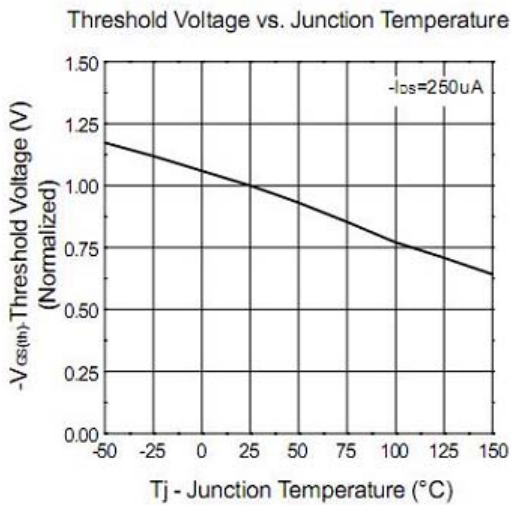
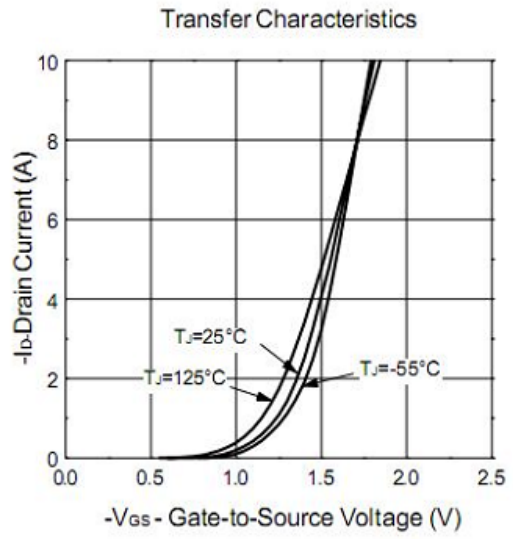
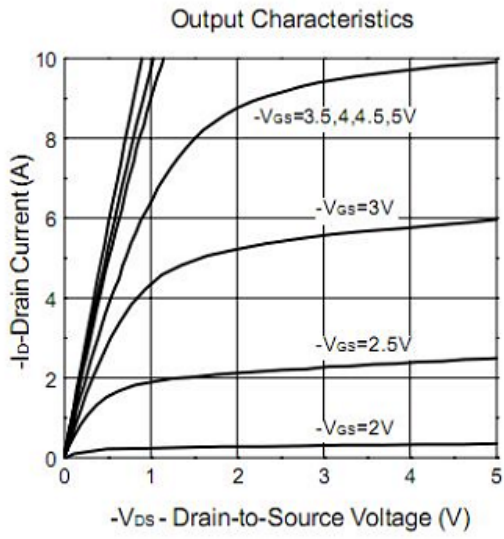

Typical Characteristics

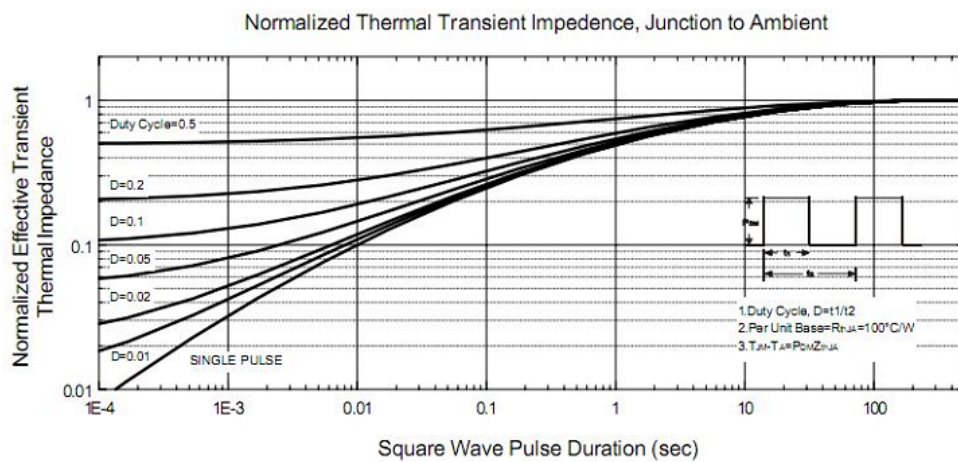
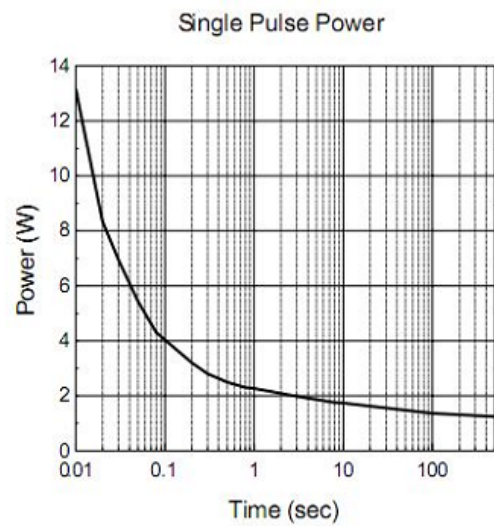
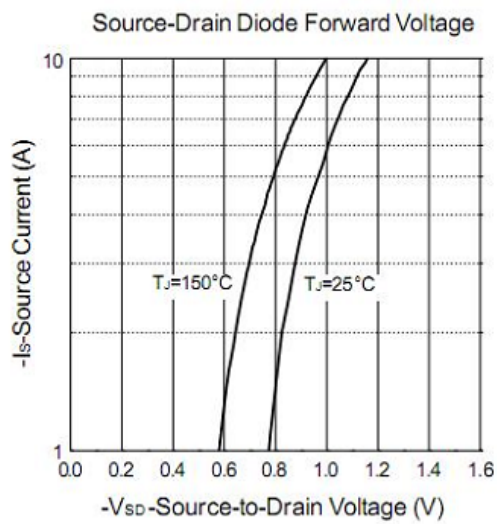
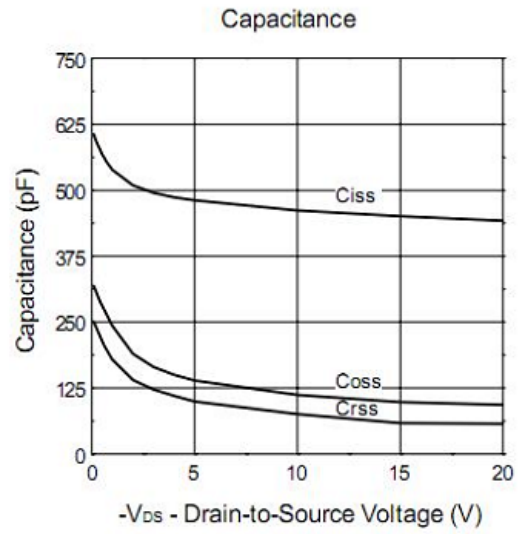
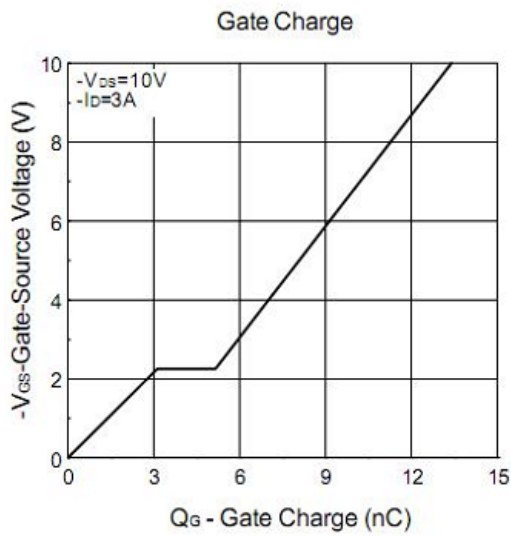

SE4607

Package Outline Dimension

SOP-8

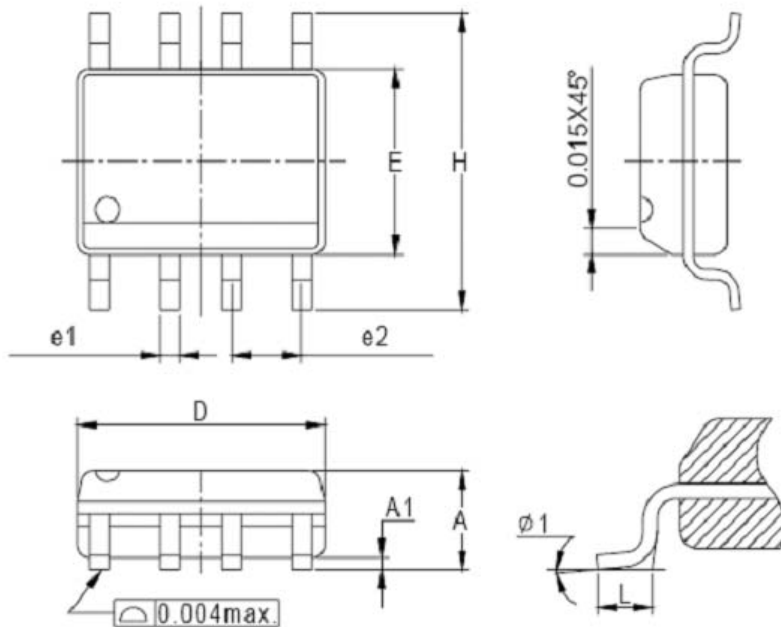

Dim	Millimeters		Inches	
	Min.	Max.	Min.	Max.
A	1.35	1.75	0.053	0.069
A1	0.10	0.25	0.004	0.010
D	4.80	5.00	0.189	0.197
E	3.80	4.00	0.150	0.157
H	5.80	6.20	0.228	0.244
L	0.40	1.27	0.016	0.050
e1	0.33	0.51	0.013	0.020
e2	1.27BSC		0.50BSC	
φ 1	8°		8°	

The SINO-IC logo is a registered trademark of ShangHai Sino-IC Microelectronics Co., Ltd.

© 2005 SINO-IC - Printed in China - All rights reserved.

SHANGHAI SINO-IC MICROELECTRONICS CO., LTD

Add: Building 3, Room 3401-03, No.200 Zhangheng Road,
ZhangJiang Hi-Tech Park, Pudong, Shanghai 201203, China

Phone: +86-21-33932402 33932403

33932405 33933508 33933608

Fax: +86-21-33932401

Email: webmaster@sino-ic.com

Website: <http://www.sino-ic.com>