

Low-profile 7.5mm height contributes to flexibility in set design



Detector

Slide

Push

Rotary

Power

Dual-in-line Package Type

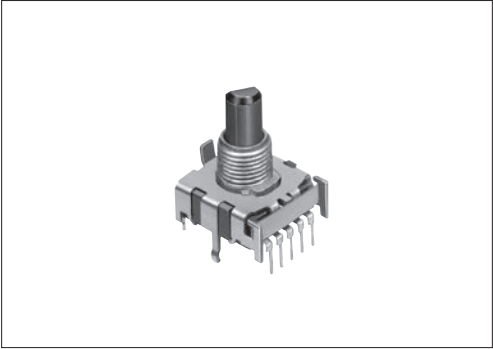

Typical Specifications

Items		Specifications
Rating (max.)/(min.) (Resistive load)		0.3A 16V DC / 50μA 3V DC
Contact resistance (Initial / After operating life)		50mΩ max. / 150mΩ max.
Rotational torque		30±15mN·m
Operating life	Without load	10,000 cycles
	With load	10,000 cycles (0.3A 16V DC)

Product Line

Poles	Positions	Changeover angle	Changeover timing	Actuator configuration	Actuator length (mm)	Minimum order unit (pcs.)		Product No.
						Japan	Export	
1	3	30±3°	Non shorting	Flat	L=15	165	330	SRBV131803
					L=20			SRBV131502
	4				L=15			SRBV141404
					L=20			SRBV141201
	5				L=15			SRBV151102
					L=20			SRBV150901
	6				L=15			SRBV160803
	7							SRBV170701
	8				L=20			SRBV170501
					L=15			SRBV181004

Packing Specifications

Tray

Number of packages (pcs.)		Export package measurements (mm)
1 case /Japan	1 case /export packing	
165	330	400×270×185

Refer to P.151 for shaft configurations.
Refer to P.158 for soldering conditions.

■ Dimensions

Unit:mm

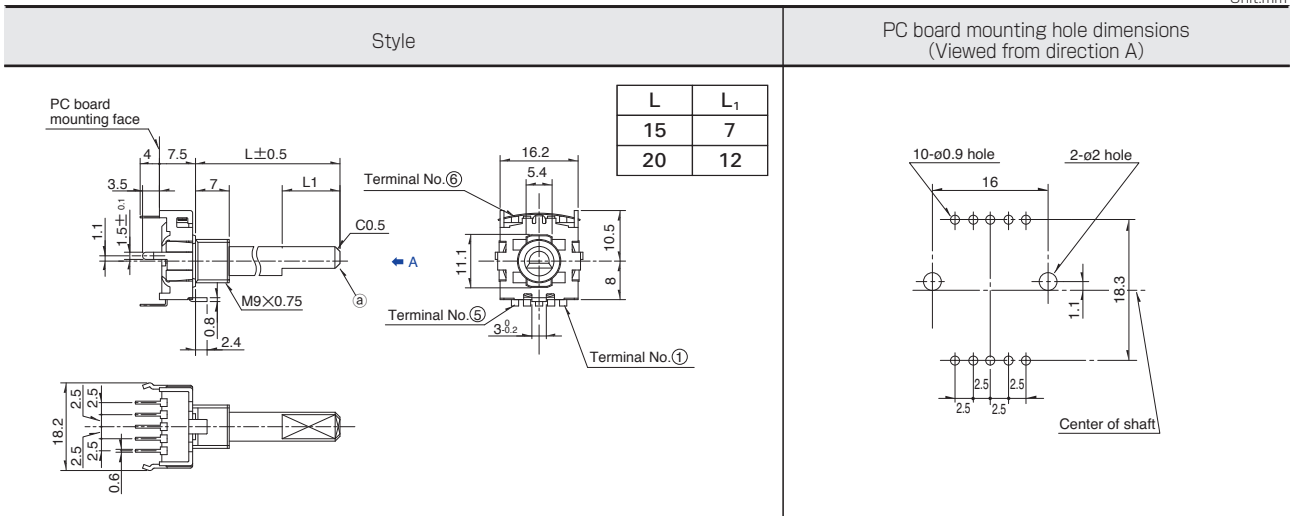

■ Operation Part Details ①

Unit:mm

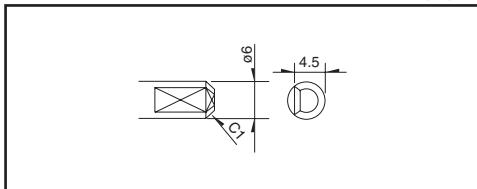

■ Standard Circuit Diagram (Viewed from Direction A)

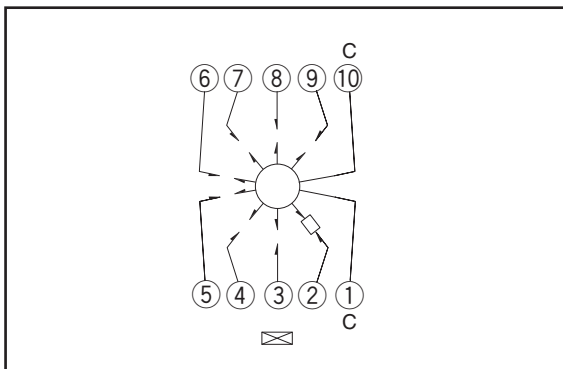

■ Dummy Terminals

3-position	⑤ ⑥ ⑦ ⑧ ⑨
4-position	⑥ ⑦ ⑧ ⑨
5-position	⑦ ⑧ ⑨
6-position	⑧ ⑨
7-position	⑨
8-position	—





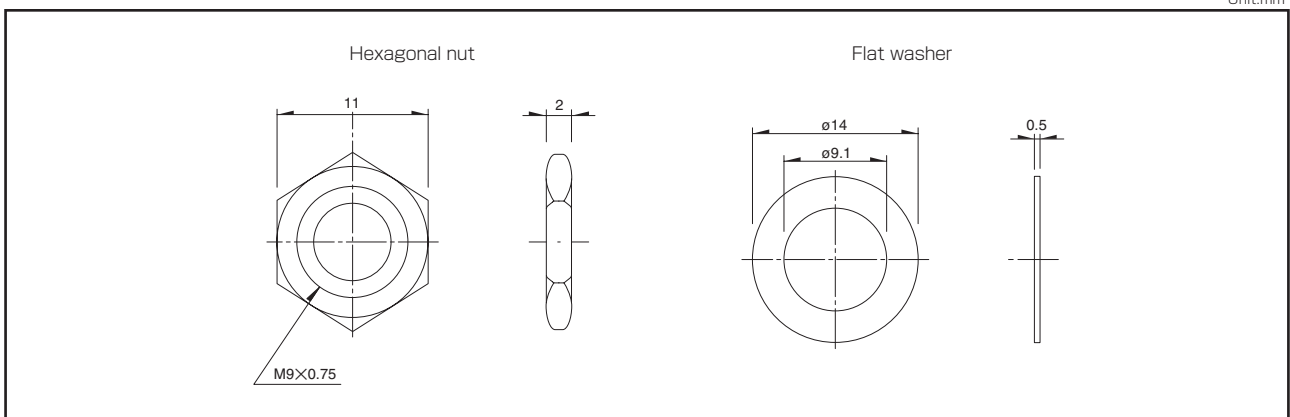







■ Attached Parts

Unit:mm



Rotary Switches

List of Varieties

Series	SRBD	SRBQ		SRBM		SRBV	SRRM	SRRN	
		Insertion	Reflow type	Rotary	Pulse				
Photo									
Angle of throw	36°	40±3°		30±3°	18±3°	30±3°			
Number of poles	1		1, 2		1		1, 2, 3, 4	2, 3, 4	
Rotational torque	13±5mN·m	6±3mN·m 13±5mN·m		40±20mN·m 15±7mN·m		30±15mN·m	80±30mN·m (Shorting) 70±30mN·m (Non shorting)	70±30mN·m	
Dimensions (mm)	W	10	11.4		10		16.2		
	D		12.4		12.5		18.5		
	H		3.5		11		7.5		
Operating temperature range	-25°C to +85°C	-10°C to +60°C		-30°C to +85°C		-10°C to +85°C	-10°C to +60°C	-30°C to +65°C	
Automotive use	—	—		—		—	—	—	
Life cycle									
Rating (max.)/(min.) (Resistive load)	1mA 5V DC 50µA 3V DC	0.1A 16V DC 50µA 3V DC				0.3A 16V DC 50µA 3V DC		0.25A 30V DC 50µA 3V DC	0.15A 12V DC 50µA 3V DC
Durability	Operating life without load	10,000 cycles 250mΩ max.	10,000 cycles 100mΩ max.		30,000 cycles 100mΩ max.		10,000 cycles 100mΩ max.	10,000 cycles 40mΩ max.	10,000 cycles 70mΩ max.
	Operating life with load Load: as rating	10,000 cycles 250mΩ max.	10,000 cycles 100mΩ max.	10,000 cycles 150mΩ max.			10,000 cycles 60mΩ max.	10,000 cycles 100mΩ max.	
Electrical performance	Initial contact resistance	200mΩ max.	50mΩ max.				20mΩ max.	50mΩ max.	
	Insulation resistance	100MΩ min. 100V DC					100MΩ min. 500V DC		
	Voltage proof	100V AC for 1minute					500V AC for 1minute		
Mechanical performance	Terminal strength	3N for 1minute	5N for 1minute				10N for 1minute	5N for 1minute	
	Actuator strength	Operating direction	—	—	0.5N·m	—	0.6N·m	1N·m	
		Pulling direction	50N	20N	100N				
	Wobble of actuator	Load at the tip of shaft SRRM, SRBM, SRRN: 5N, SRBQ, SRBV: 1N							
The below table shows for SRRM, SRBM, SRRN			The below table shows for SRBQ			The below table shows for SRBV			
Measuring position from mounting surface		Shaft wobble (max. value)	Applicable mounting dimension	Distance from mounting surface to the tip of shaft	Shaft wobble (max. value)	Measuring position from mounting surface	Shaft wobble (max. value)	Applicable mounting dimension	
10		0.17	15	below 5	0.5	10	0.2	15	
15		0.25	20	above 5 and below 10	0.9	15	0.3	20	
20	0.35	25	above 10 and below 15	1.2	20	0.4	25		
25	0.42	30							
30	0.5	above 35							
Unit:mm									
Environmental performance	Cold	-40°C 500h	-20°C 96h	-40°C 96h		-20°C 96h		-40°C 96h	
	Dry heat	85°C 500h	85°C 96h						
	Damp heat	60°C, 90 to 95%RH 500h	40°C, 90 to 95%RH 96h						
Page	143	145	147	150	152	155			

Rotary Switches Soldering Conditions 158
 Rotary Switches Cautions 159

Rotary Switches Soldering Conditions

Example of Reflow Soldering Condition

1. Heating method: Double heating method with infrared heater.
2. Temperature measurement: Thermocouple $\phi 0.1$ to 0.2 CA (K) or CC (T) at soldering portion (copper foil surface). A heat resisting tape should be used for fixed measurement.
3. Temperature profile

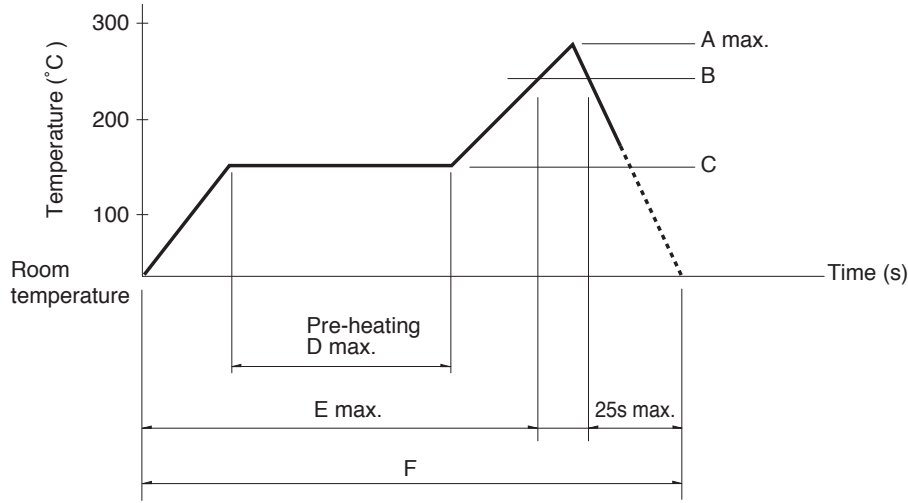

Series (Reflow type)	A (°C) 3s max.	B (°C)	C (°C)	D (s)	E (s)	F (s)
SRBQ	250	200	150±5	80 to 100	—	—

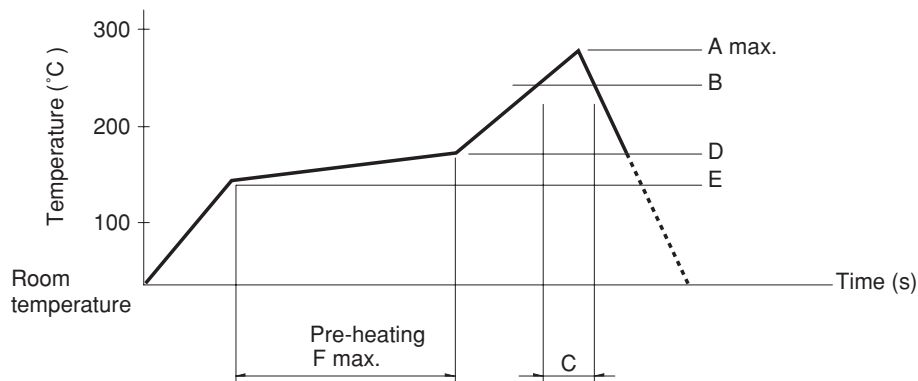

Series (Reflow type)	A (°C) 3s max.	B (°C)	C (s)	D (°C)	E (°C)	F (s)
SRBD	260	230	40	180	150	120

- Notes**
1. The condition mentioned above is the temperature on the mounting surface of a PC board. There are cases where the PC board's temperature greatly differs from that of the switch, depending on the PC board's material, size, thickness, etc. The above-stated conditions shall also apply to switch surface temperatures.
 2. Soldering conditions differ depending on reflow soldering machines. Prior verification of soldering condition is highly recommended.

Reference for Hand Soldering

Series	Soldering temperature	Soldering time
SRBQ, SRBM, SRBV, SRRM, SRRN	350±10°C	3+1/0s
SRBQ (Reflow type)	350±5°C	3s max.

Reference for Dip Soldering

(For PC board terminal types)

Series	Items		Dip soldering	
	Preheating temperature	Preheating time	Soldering temperature	Duration of immersion
SRBM	100°C max.	60s max.	260±5°C	5s max.
SRBV, SRRM, SRRN	—	—	260±5°C	10±1s
SRBQ	—	—	260±5°C	5±1s