

FEATURES

- ※ Compact-sized 2.8x3.8mm
- ※ Vertical or side actuation
- ※ Wide stem

APPLICATION

- ※ Automotive
- ※ Portable electronic device
- ※ Control panel

SPECIFICATION

Contact Rating	50mA, 12V DC
Contact Resistance	100mΩ max.
Insulation Resistance	100MΩ min. 500V DC
Dielectric Strength	100V AC/1 minute
Operating Force	100±50gf, 160±50gf (Vertical Push) 200±65gf (Side Push) 300±80gf, 400±80gf (Vertical Push)
Travel	0.13mm (Vertical Push) 0.20mm (Side Push)
Operating Life	50,000 cycles for 300/400gf 100,000 cycles for 100/160/200gf
Operating Temp.	-20°C ~ +70°C
Storage Temp.	-30°C ~ +80°C

HOW TO ORDER

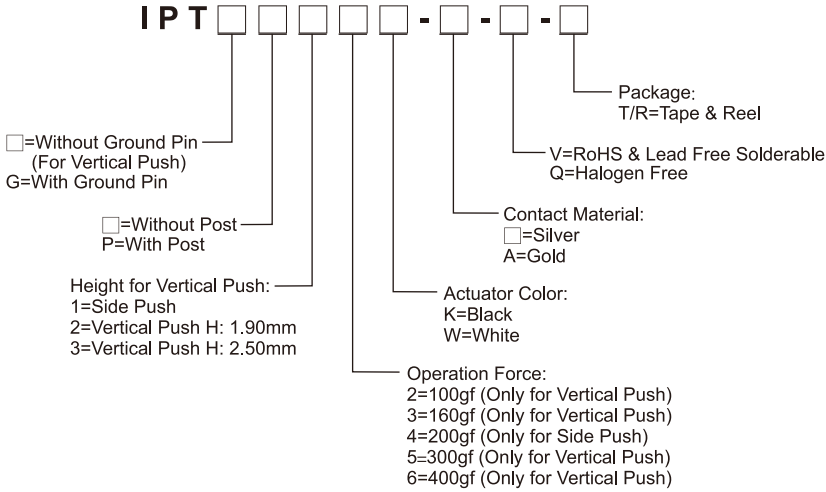

CIRCUIT

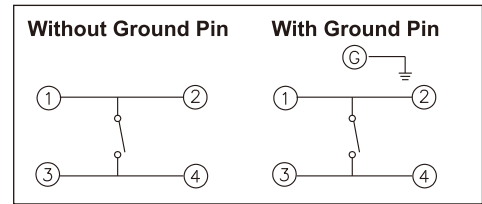

PACKAGE

<Tape & Reel>
IPTGP1: 3000 pcs
IPTG1: 3500 pcs
IPTG2: 7000 pcs
IPTG3: 6000 pcs

IPTG

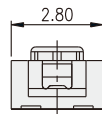
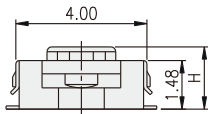
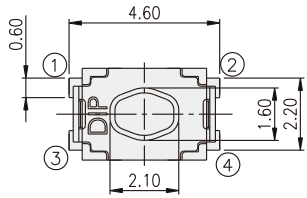

PART NO.	H
IPTG2	1.90
IPTG3	2.50

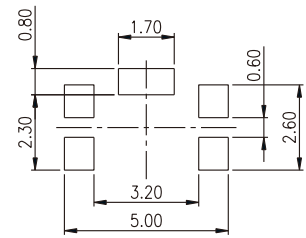

P.C.B. LAYOUT

IPTG1

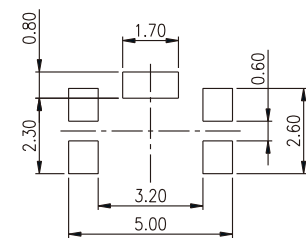
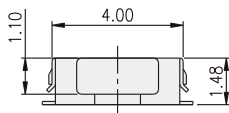
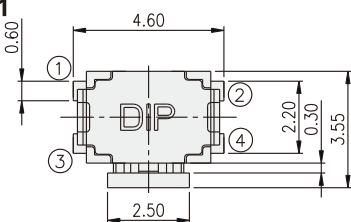

P.C.B. LAYOUT