

深圳市晶科鑫实业有限公司

样品承认书

客户代码:	
物料名称:	贴片钟振
规格型号:	3225 OSC 14.31818MHZ 1.8~3.3V ±30PPM CMOS
P N/ SJK:	3N14318G33YC

承 认 签 章					
供 应 商 承 认			() 公 司 承 认		
制 定	审 核	核 准	工 程 师	审 核	批 准
林雁	杨霞	黄灏东			
盖章签署			盖章签署		
日 期			日 期		
批示: <input type="checkbox"/> 接受 <input type="checkbox"/> 有条件接受					
备注:					

公司地址: 深圳市龙岗区天安云谷产业园一期3栋C座12楼1204~1206室

电 话: 0755-88352810-837 传 真: 0755-88353718

CRYSTAL OSCILLATOR



SERIES 3N, SEAM SEALED CERAMIC 3.2X2.5MM SURFACE MOUNT PACKAGE

Approved by: 黄灏东
Checked by: 杨霞
Issued by: 玉静霞

产品规格书

SPECIFICATION

PN / SJK: **3N14318G33YC**

深圳市晶科鑫实业有限公司

SHENZHEN CRYSTAL TECHNOLOGY INDUSTRIAL CO., LTD.

公司地址: 深圳市龙岗区天安云谷产业园一期3栋C座12楼1204~1206室

电 话: 0755-88352810-837 传 真: 0755-88353718

<http://www.q-crystal.com> Email: sjk-fae@q-crystal.com Mobile: 18682088994 (Mr.huang)



CRYSTAL OSCILLATOR

SERIES 3N, SEAM SEALED CERAMIC 3.2X2.5MM SURFACE MOUNT PACKAGE

1. ELECTRICAL SPECIFICATIONS

Standard atmospheric conditions

Unless otherwise specified, the standard range of atmospheric conditions for making measurement and tests are as follow:

Ambient temperature : 25±5°C

Relative humidity : 40%~70%

If there is any doubt about the results, measurement shall be made within the following limits:

Ambient temperature : 25±3°C

Relative humidity : 40%~70%

Measure equipment

Electrical characteristics measured by MD 37WX-05M or equivalent.

Crystal cutting type

The crystal is using AT CUT (thickness shear mode).

	Parameters		SYM	Electrical Spec.				Notes
				MIN	TYPE	MAX	UNITS	
1	Nominal Frequency			14.318180			MHZ	
2	Frequency Stability	AT 25°C		±10			PPM	
		Over Operating Temperature range		±20			PPM	
3	Operating Temperature		Topr	-40	25	85	°C	
4	Storage Temperature		Tstg	-55	~	125	°C	
5	Supply Voltage		VDD	1.8~3.3 ±10%			V	
6	Input Current		Icc			5	mA	
7	Enable Control			Yes				Pad1
8	Output Load : CMOS		CL	15			pF	
9	Output Voltage High		VoH	90% Vdd			V	
10	Output Voltage Low		VoL			10% Vdd	V	
11	Rise Time		Tr			5	ns	10%→90%VDD Level
12	Fall Time		Tf			5	ns	90%→10%VDD Level
13	Symmetry (Duty ratio)		TH/T	45	~	55	%	
14	Start-up Time		Tosc			10	ms	
15	Enable Voltage High		Vhi	70% Vdd			V	
16	Disable Voltage Low		Vlo			30% Vdd	V	
17	Aging			±3			ppm/yr.	1st. Year at 25°C
18	Output Disable Delay Time		T off			150	us	
19	Output Enable Delay Time		T on			150	us	
20	Phase Jitter (12KHZ~20MHZ)				0.5	1.0	ps	

CRYSTAL OSCILLATOR

SERIES 3N, SEAM SEALED CERAMIC 3.2X2.5MM SURFACE MOUNT PACKAGE

2. DIMENSIONS (Units :mm)

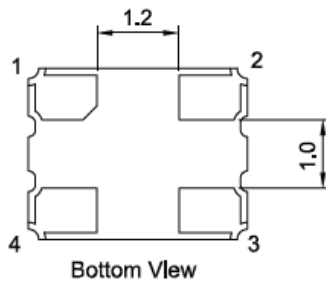
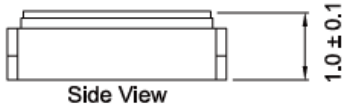
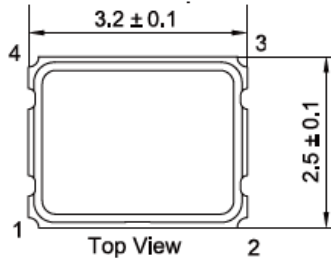

- PAD FUNCTION:**
- 1: ENABLE CONTROL
 - 2: GND
 - 3: OUT
 - 4: VDD

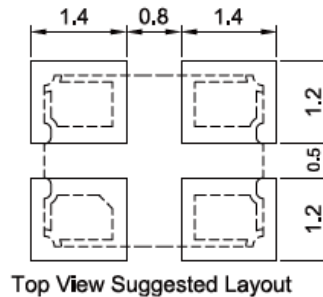

MARKING

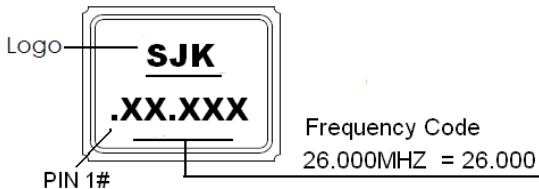

3. TEST CIRCUIT

Control input (output enable/disable)
Logic 1 or open on pad 1: Oscillator output

Logic 0 on pad 1 : Disable output to high impedance

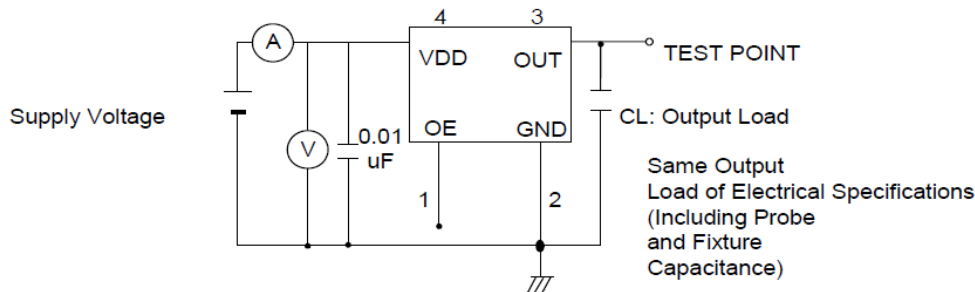

4. PART NUMBER GUIDE

SJK -	3N	14318	G	33	Y	C
		Frequency 14.13818MHz	Frequency tolerance G:±30ppm	Supply voltage 33:1.8~3.3V	Fan out type X:TTL/CMOS Y:CMOS Z:TTL	Temperature range C: -40-85°C

CRYSTAL OSCILLATOR

SERIES 3N, SEAM SEALED CERAMIC 3.2X2.5MM SURFACE MOUNT PACKAGE

5. WAVEFORM CONDITIONS

Waveform measurement system should have a min. bandwidth of 5 times the frequency being tested.

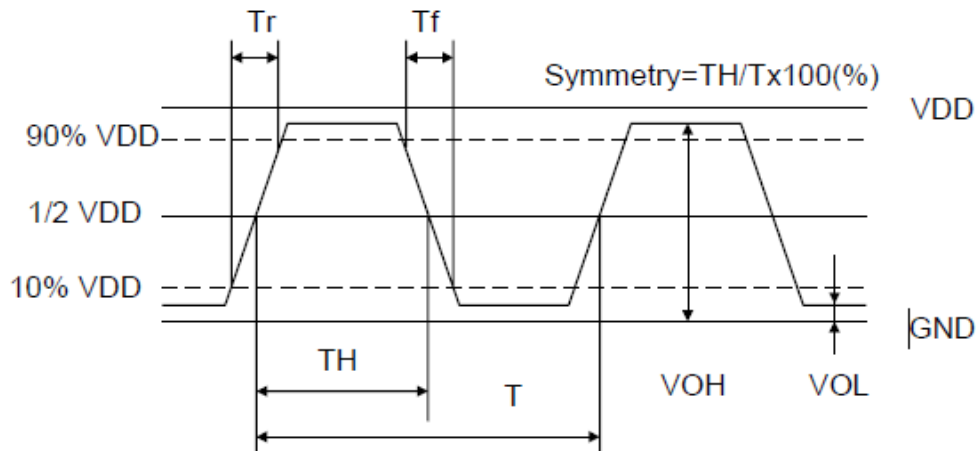

6. OUTPUT ENABLE / DISABLE DELAY

The following figure shows the oscillator timing during normal operation. Note that when the device is in standby, the oscillator stops. When standby is released, the oscillator starts and stable oscillator output occurs after a short delay.

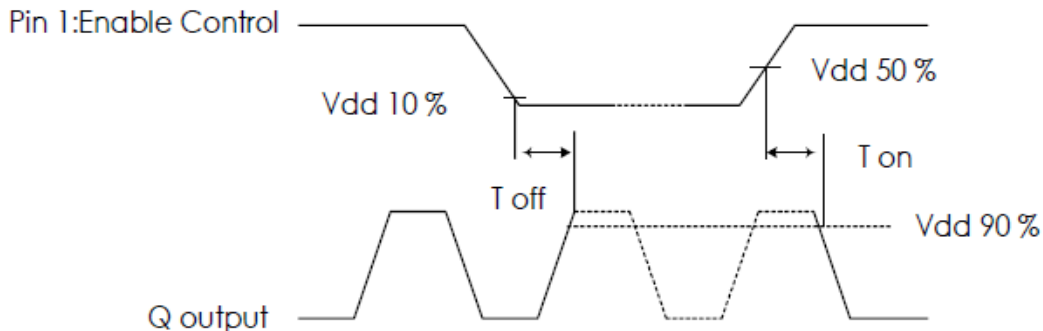

7. SUGGESTED REFLOW PROFILE

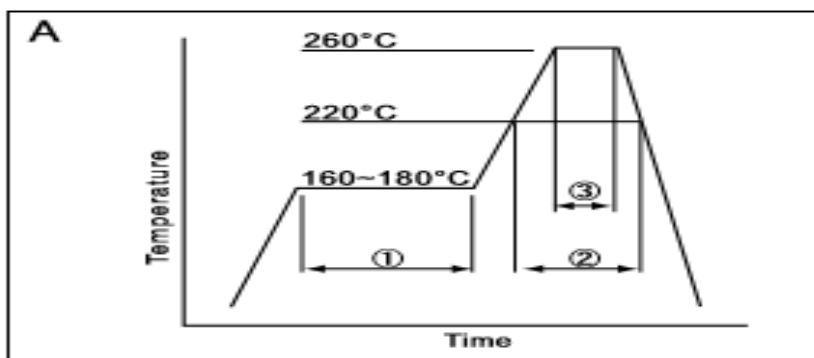

①	Preheat	160~180°C	120sec.
②	Primary heat	220°C	60sec.
③	Peak	260°C	10sec. max

Total time : 200 sec. Max / Solder melting point : 220 °C

CRYSTAL OSCILLATOR

SERIES 3N, SEAM SEALED CERAMIC 3.2X2.5MM SURFACE MOUNT PACKAGE

8. STRUCTURE ILLUSTRATION

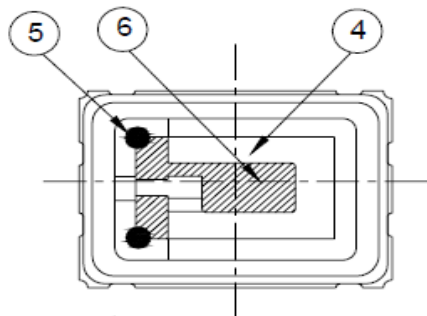

A-A' sectional drawing

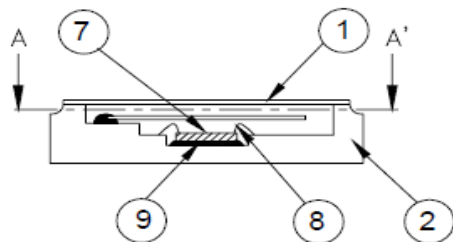

B-B' sectional drawing

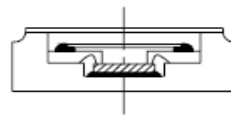

C-C' sectional drawing

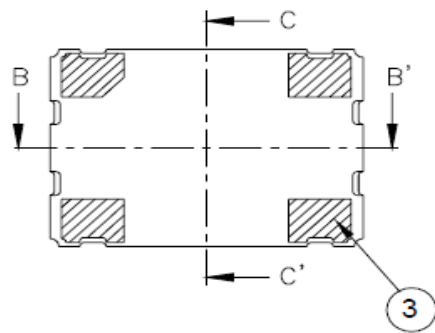

NO	COMPONENTS	MATERIALS	FINISH/SPECIFICATIONS
1	LID	Kovar (Fe/Co/Ni)	
2	Base(Package)	Ceramic (Al ₂ O ₃) + Kovar (Fe/Co/Ni)+ Ag/Cu	Color black
3	PAD	Au	Tungsten metalize + Ni plating + Au plating
4	Crystal blank	SiO ₂	
5	Conductive adhesive	Ag	Silicon resin
6	Electrode	Noble Metal	
7	IC chip		
8	Bonding wire	Au	Pad 1 options : NC is 5 wires , EN is 6 wires.
9	Die attached	Conductive (Ag)	Epoxy resin

CRYSTAL OSCILLATOR

SERIES 3N, SEAM SEALED CERAMIC 3.2X2.5MM SURFACE MOUNT PACKAGE

9. PACKING

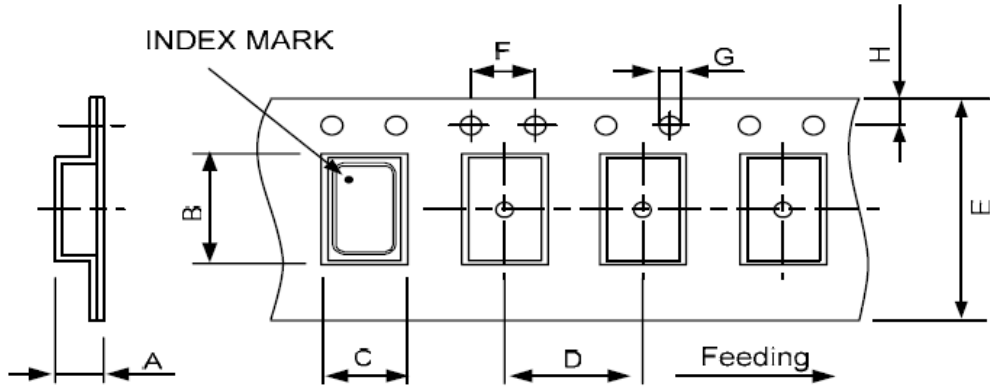

DIMENSIONS	A	B	C	D	E	F	G	H	
	2.30	7.90	5.45	8.00	16.00	4.00	1.50	1.75	(UNIT : mm)

REMARK :

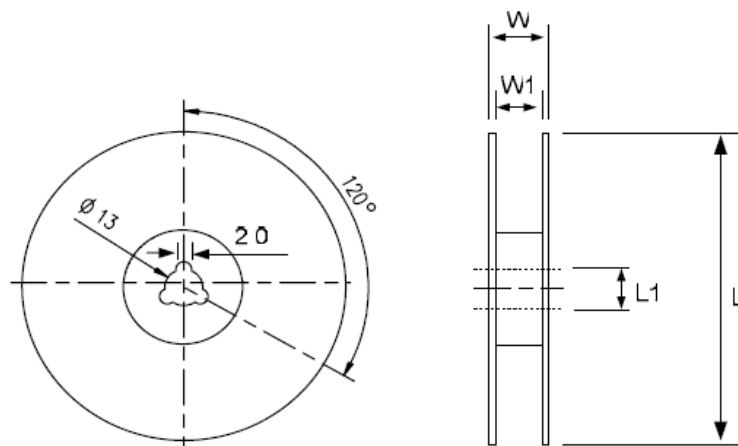
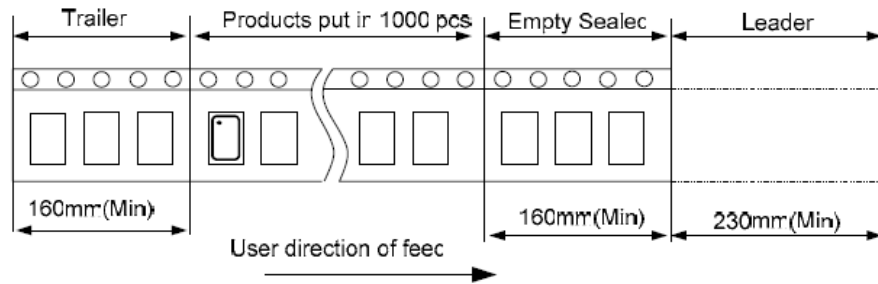

DIMENSIONS	L	L1	W	W1	pcs / Reel (UNIT : mm)
	180	13	20.5	16	Standard Reel Quantity is 1,000 pcs per reel

CRYSTAL OSCILLATOR

SERIES 3N, SEAM SEALED CERAMIC 3.2X2.5MM SURFACE MOUNT PACKAGE

10. RELIABILITY TEST SPECIFICATION

1. Mechanical Endurance

No.	Test Item	Test Methods	REF. DOC
1	Drop Test	75 cm height, 3 times on concrete floor .	JIS C6701
2	Mechanical Shock	Device are shocked to half sine wave (1000 G) three mutually perpendicular axes each 3 times. 0.5m sec. duration time	MIL-STD-202F
3	Vibration	Frequency range 10 ~ 2000 Hz Amplitude 1.52 mm/20G Sweep time 20 minutes Perpendicular axes each test time 4 Hrs (Total test time 12 Hrs)	MIL-STD-883E
4	Gross Leak	Standard Sample For Automatic Gross Leak Detector, Test Pressure: 2kg / cm ²	MIL-STD-883E
5	Fine Leak	Helium Bomging 4.5 kgf / cm ² for 2 Hrs	
6	Solderability	Temperature 245 °C ± 5°C Immersing depth 0.5 mm minimum Immersion time 5 ± 1 seconds Flux Rosin resin methyl alcohol solvent (1 : 4)	MIL-STD-883E

2. Environmental Endurance

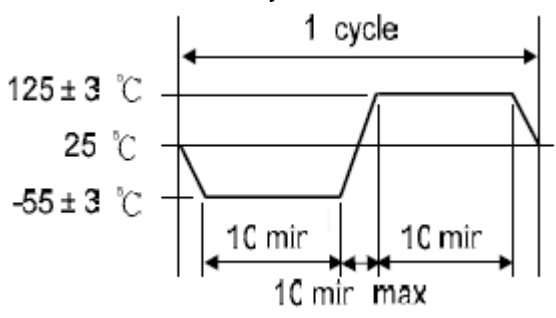
No.	Test Item	Test Methods	REF. DOC
1	Resistance To Soldering Heat	Pre-heat temperature 125 °C Pre-heat time 60 ~ 120 sec. Test temperature 260 ± 5 °C Test time 10 ± 1 sec.	MIL-STD-202F
2	High Temp. Storage	+ 125 °C ± 3 °C for 1000 ± 12 Hrs	MIL-STD-883E
3	Low Temp. Storage	- 40 °C ± 3 °C for 1000 ± 12 Hrs	
4	Thermal Shock	Total 100 cycles of the following temperature cycle 	MIL-STD-883E
5	Pressure Cooker Storage	121 ± 3 °C , RH100% , 2 bar , 240 Hrs	JIS C6701
6	High Temp & Humidity	85 °C ± 3 °C , RH 85% , 1000 Hrs	JIS C5023