

# NCV8114

## 300 mA CMOS Low Dropout Regulator

The NCV8114 is 300 mA LDO that provides the engineer with a very stable, accurate voltage with low noise suitable for space constrained, noise sensitive applications. In order to optimize performance for battery operated portable applications, the NCV8114 employs the dynamic quiescent current adjustment for very low  $I_Q$  consumption at no-load.

### Features

- Operating Input Voltage Range: 1.7 V to 5.5 V
- Available in Fixed Voltage Options: 0.9 V to 3.6 V Contact Factory for Other Voltage Options
- Very Low Quiescent Current of Typ. 50  $\mu\text{A}$
- Standby Current Consumption: Typ. 0.1  $\mu\text{A}$
- Low Dropout: 135 mV Typical at 300 mA
- $\pm 1\%$  Accuracy at Room Temperature
- High Power Supply Ripple Rejection: 75 dB at 1 kHz
- Thermal Shutdown and Current Limit Protections
- Stable with a 1  $\mu\text{F}$  Ceramic Output Capacitor
- Available in TSOP Package
- NCV Prefix for Automotive and Other Applications Requiring Unique Site and Control Change Requirements; AEC-Q100 Qualified and PPAP Capable
- These Devices are Pb-Free, Halogen Free/BFR Free and are RoHS Compliant

### Typical Applications

- Parking Camera Modules
- Wireless Handsets, Wireless LAN, Bluetooth<sup>®</sup>, Zigbee<sup>®</sup>
- Automotive Infotainment Systems
- Other Battery Powered Applications

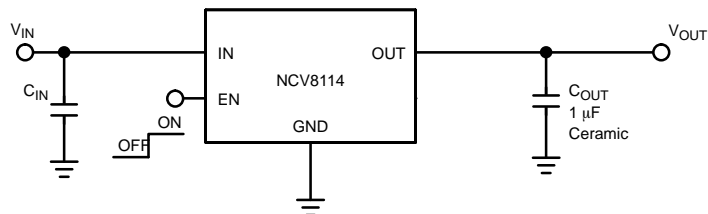
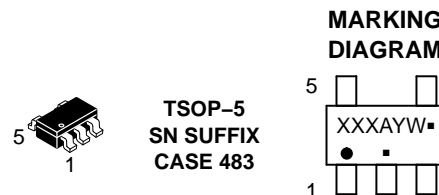

Figure 1. Typical Application Schematic



ON Semiconductor<sup>®</sup>

[www.onsemi.com](http://www.onsemi.com)



XXX = Specific Device Code  
A = Assembly Location  
Y = Year  
W = Work Week  
■ = Pb-Free Package

(Note: Microdot may be in either location)

### PIN CONNECTIONS

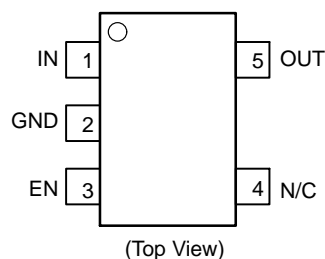

(Top View)

### ORDERING INFORMATION

See detailed ordering, marking and shipping information on page 11 of this data sheet.

# NCV8114

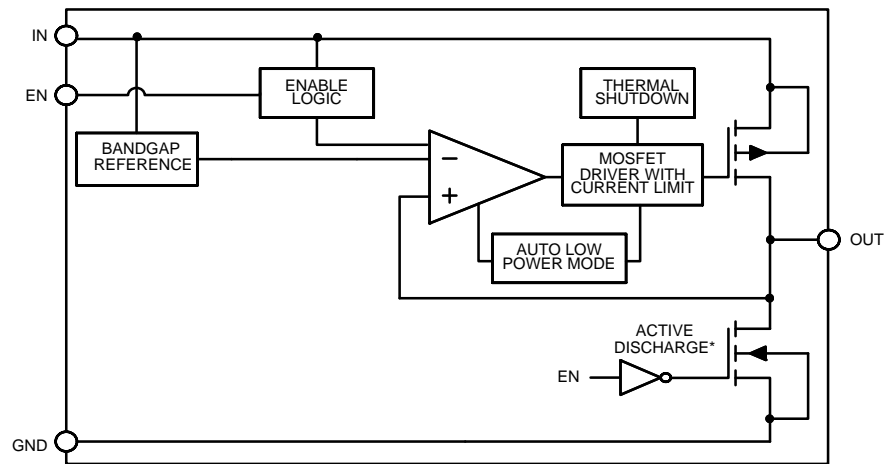

\*Active output discharge function is present only in NCV8114ASNyyyTCG devices.  
yyy denotes the particular  $V_{OUT}$  option.

**Figure 2. Simplified Schematic Block Diagram**

## PIN FUNCTION DESCRIPTION

Pin No.	Pin Name	Description
5	OUT	Regulated output voltage pin. A small ceramic capacitor with minimum value of 1 $\mu\text{F}$ is needed from this pin to ground to assure stability.
2	GND	Power supply ground.
3	EN	Driving EN over 0.9 V turns on the regulator. Driving EN below 0.4 V puts the regulator into shutdown mode.
1	IN	Input pin. A small capacitor is needed from this pin to ground to assure stability.
4	N/C	Not connected. This pin can be tied to ground to improve thermal dissipation.

## ABSOLUTE MAXIMUM RATINGS

Rating	Symbol	Value	Unit
Input Voltage (Note 1)	$V_{IN}$	-0.3 V to 6 V	V
Output Voltage	$V_{OUT}$	-0.3 V to $V_{IN} + 0.3$ V or 6 V	V
Enable Input	$V_{EN}$	-0.3 V to $V_{IN} + 0.3$ V or 6 V	V
Output Short Circuit Duration	tSC	$\infty$	s
Maximum Junction Temperature	$T_{J(MAX)}$	150	$^{\circ}\text{C}$
Operating Ambient Temperature	$T_A$	-40 to 125	$^{\circ}\text{C}$
Storage Temperature	$T_{STG}$	-55 to 150	$^{\circ}\text{C}$
ESD Capability, Human Body Model (Note 2)	$ESD_{HBM}$	2000	V
ESD Capability, Machine Model (Note 2)	$ESD_{MM}$	200	V

Stresses exceeding those listed in the Maximum Ratings table may damage the device. If any of these limits are exceeded, device functionality should not be assumed, damage may occur and reliability may be affected.

1. Refer to ELECTRICAL CHARACTERISTICS and APPLICATION INFORMATION for Safe Operating Area.
2. This device series incorporates ESD protection and is tested by the following methods:  
ESD Human Body Model tested per EIA/JESD22-A114,  
ESD Machine Model tested per EIA/JESD22-A115,  
Latchup Current Maximum Rating tested per JEDEC standard: JESD78.

# NCV8114

## THERMAL CHARACTERISTICS (Note 3)

Rating	Symbol	Value	Unit
Thermal Characteristics, TSOP-5 Thermal Resistance, Junction-to-Air	$R_{\theta JA}$	259.9	$^{\circ}\text{C}/\text{W}$

3. Single component mounted on 1 oz, FR 4 PCB with 645 mm<sup>2</sup> Cu area.

## RECOMMENDED OPERATING CONDITIONS

Rating	Symbol	Min	Typ	Max	Unit
Input Voltage	$V_{IN}$	1.7		5.5	V
Junction Temperature	$T_J$	-40		+125	$^{\circ}\text{C}$

Functional operation above the stresses listed in the Recommended Operating Ranges is not implied. Extended exposure to stresses beyond the Recommended Operating Ranges limits may affect device reliability.

**ELECTRICAL CHARACTERISTICS**  $-40^{\circ}\text{C} \leq T_J \leq 125^{\circ}\text{C}$ ;  $V_{IN} = V_{OUT(NOM)} + 1\text{ V}$  for  $V_{OUT}$  options greater than 1.5 V. Otherwise  $V_{IN} = 2.5\text{ V}$ , whichever is greater;  $I_{OUT} = 1\text{ mA}$ ,  $C_{IN} = C_{OUT} = 1\text{ }\mu\text{F}$ , unless otherwise noted.  $V_{EN} = 0.9\text{ V}$ . Typical values are at  $T_J = +25^{\circ}\text{C}$ . Min./Max. are for  $T_J = -40^{\circ}\text{C}$  and  $T_J = +125^{\circ}\text{C}$  respectively (Note 4).

Parameter	Test Conditions	Symbol	Min	Typ	Max	Unit	
Operating Input Voltage		$V_{IN}$	1.7		5.5	V	
Output Voltage Accuracy	$-40^{\circ}\text{C} \leq T_J \leq 125^{\circ}\text{C}$	$V_{OUT} \leq 2.0\text{ V}$	$V_{OUT}$	-40	+50	mV	
		$V_{OUT} > 2.0\text{ V}$		-2	+3	%	
Line Regulation	$V_{OUT} + 0.5\text{ V} \leq V_{IN} \leq 5.5\text{ V}$ ( $V_{IN} \geq 1.7\text{ V}$ )	$\text{Reg}_{LINE}$		0.01	0.1	%/V	
Load Regulation	$I_{OUT} = 1\text{ mA}$ to 300 mA	$\text{Reg}_{LOAD}$		28	45	mV	
Load Transient	$I_{OUT} = 1\text{ mA}$ to 300 mA or 300 mA to 1 mA in 1 $\mu\text{s}$ , $C_{OUT} = 1\text{ }\mu\text{F}$	$\text{Tran}_{LOAD}$		-50/ +30		mV	
Dropout Voltage (Note 5)	$I_{OUT} = 300\text{ mA}$	$V_{OUT} = 1.5\text{ V}$	$V_{DO}$		380	500	mV
		$V_{OUT} = 1.85\text{ V}$			260	370	
		$V_{OUT} = 2.8\text{ V}$			170	270	
		$V_{OUT} = 3.0\text{ V}$			160	260	
		$V_{OUT} = 3.1\text{ V}$			155	250	
		$V_{OUT} = 3.3\text{ V}$			150	240	
Output Current Limit	$V_{OUT} = 90\% V_{OUT(nom)}$	$I_{CL}$	300	600		mA	
Ground Current	$I_{OUT} = 0\text{ mA}$	$I_Q$		50	95	$\mu\text{A}$	
Shutdown Current	$V_{EN} \leq 0.4\text{ V}$ , $V_{IN} = 5.5\text{ V}$	$I_{DIS}$		0.01	1	$\mu\text{A}$	
EN Pin Threshold Voltage High Threshold Low Threshold	$V_{EN}$ Voltage increasing $V_{EN}$ Voltage decreasing	$V_{EN\_HI}$ $V_{EN\_LO}$	0.9		0.4	V	
EN Pin Input Current	$V_{EN} = 5.5\text{ V}$	$I_{EN}$		0.3	1.0	$\mu\text{A}$	
Power Supply Rejection Ratio	$V_{IN} = 4.3\text{ V}$ , $V_{OUT} = 3.3\text{ V}$ $I_{OUT} = 10\text{ mA}$	$f = 1\text{ kHz}$ $\text{PSRR}$		75		dB	
Output Noise Voltage	$V_{IN} = 2.5\text{ V}$ , $V_{OUT} = 1.8\text{ V}$ , $I_{OUT} = 150\text{ mA}$ $f = 10\text{ Hz}$ to 100 kHz	$V_N$		70		$\mu\text{V}_{rms}$	
Thermal Shutdown Temperature	Temperature increasing from $T_J = +25^{\circ}\text{C}$	$T_{SD}$		160		$^{\circ}\text{C}$	
Thermal Shutdown Hysteresis	Temperature falling from $T_{SD}$	$T_{SDH}$		20		$^{\circ}\text{C}$	
Active Output Discharge Resistance	$V_{EN} < 0.4\text{ V}$ , Version A only	$R_{DIS}$		100		$\Omega$	

Product parametric performance is indicated in the Electrical Characteristics for the listed test conditions, unless otherwise noted. Product performance may not be indicated by the Electrical Characteristics if operated under different conditions.

4. Performance guaranteed over the indicated operating temperature range by design and/or characterization. Production tested at  $T_J = T_A = 25^{\circ}\text{C}$ . Low duty cycle pulse techniques are used during testing to maintain the junction temperature as close to ambient as possible.
5. Characterized when  $V_{OUT}$  falls 100 mV below the regulated voltage at  $V_{IN} = V_{OUT(NOM)} + 1\text{ V}$ .

TYPICAL CHARACTERISTICS

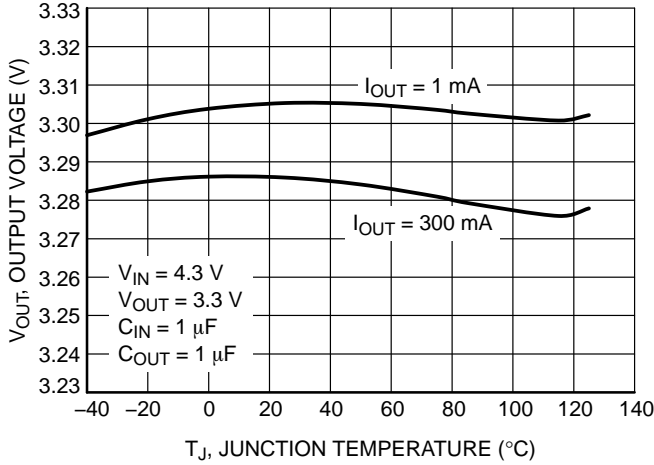

Figure 3. Output Voltage vs. Temperature –  $V_{OUT} = 3.3\text{ V}$

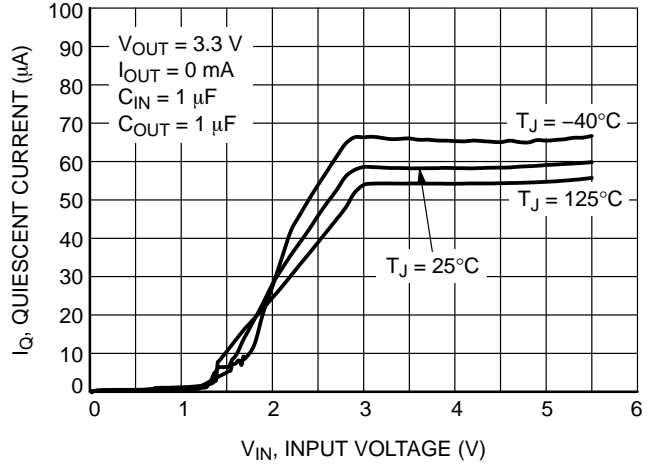

Figure 4. Quiescent Current vs. Input Voltage

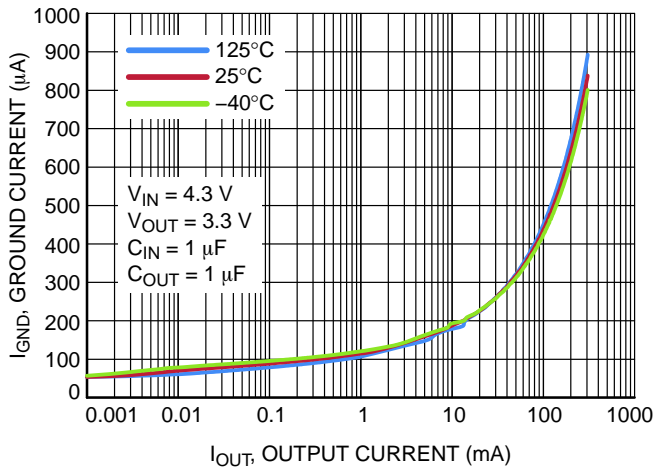

Figure 5. Ground Current vs. Output Current

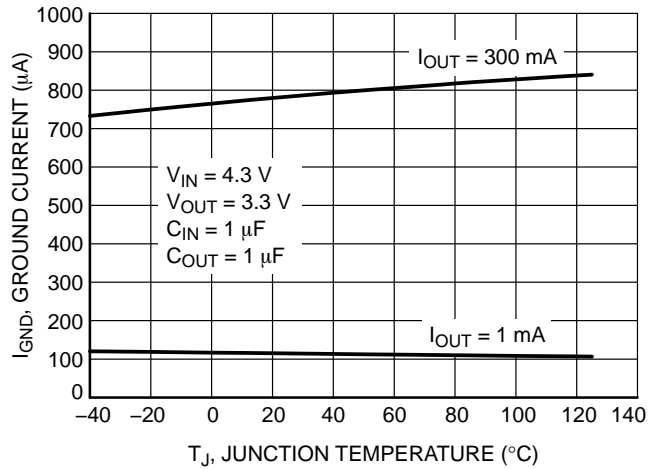

Figure 6. Ground Current vs. Temperature

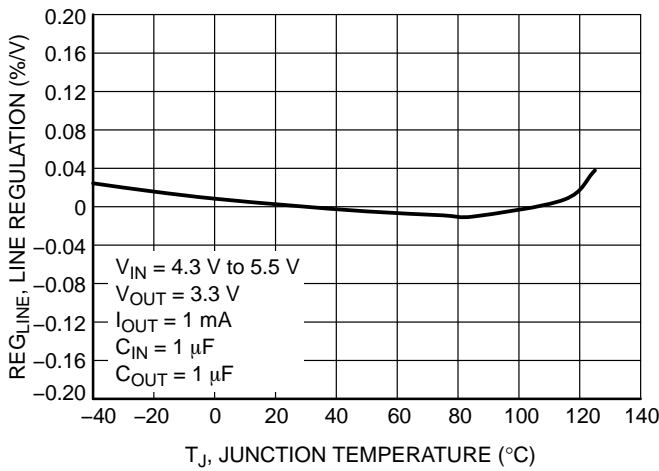

Figure 7. Line Regulation vs. Temperature

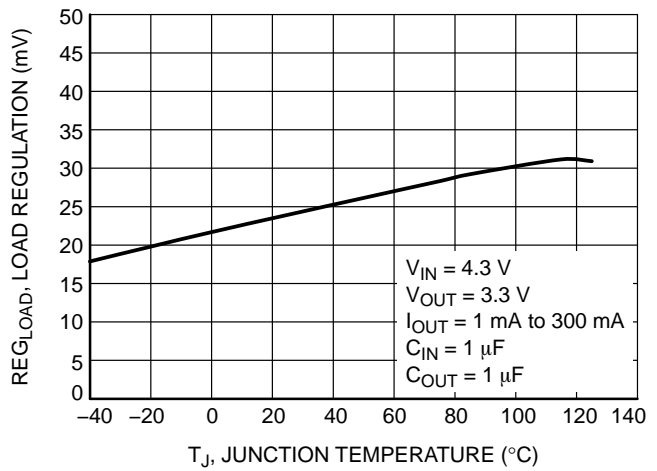

Figure 8. Load Regulation vs. Temperature

TYPICAL CHARACTERISTICS

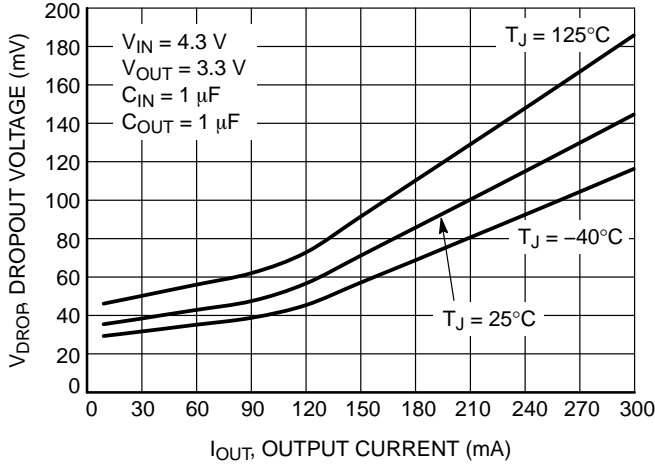

Figure 9. Dropout Voltage vs. Output Current

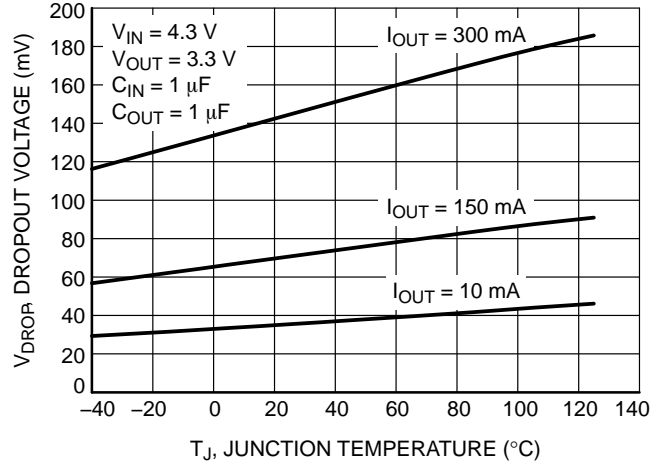

Figure 10. Dropout Voltage vs. Temperature

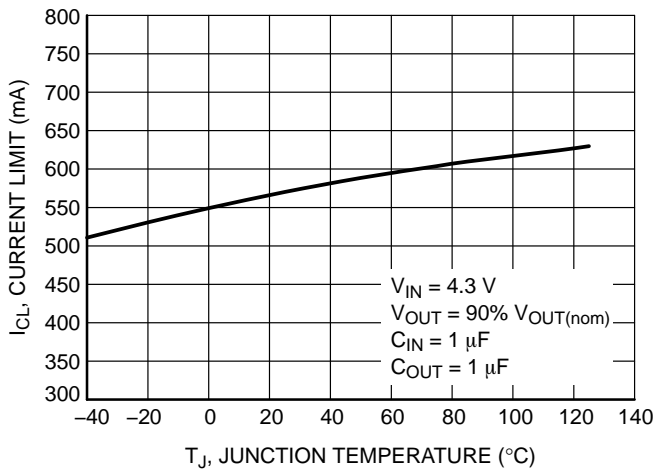

Figure 11. Current Limit vs. Temperature

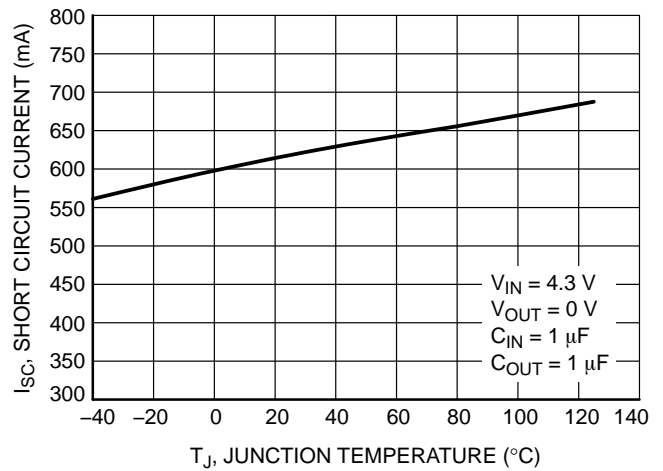

Figure 12. Short Circuit Current vs. Temperature

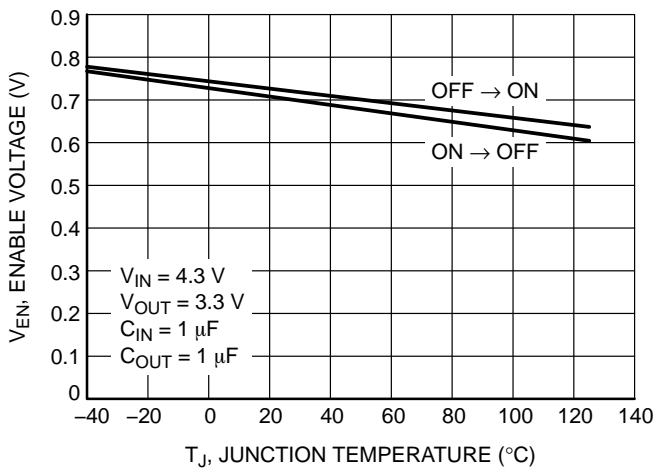

Figure 13. Enable Voltage Threshold vs. Temperature

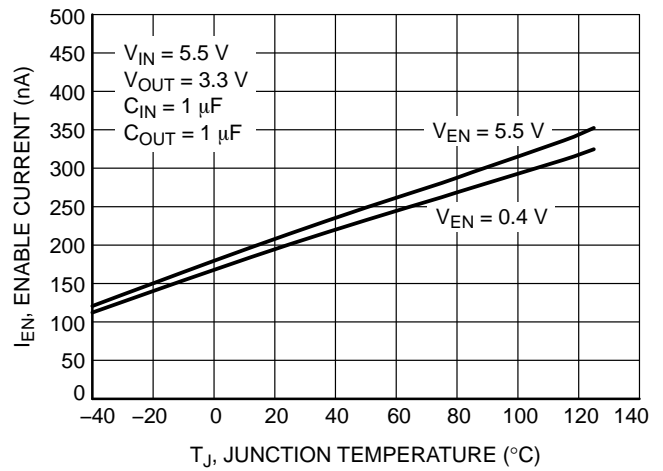

Figure 14. Current to Enable Pin vs. Temperature

TYPICAL CHARACTERISTICS

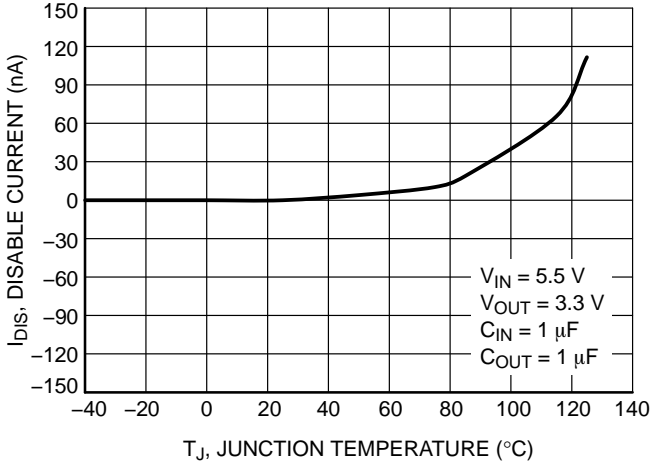

Figure 15. Disable Current vs. Temperature

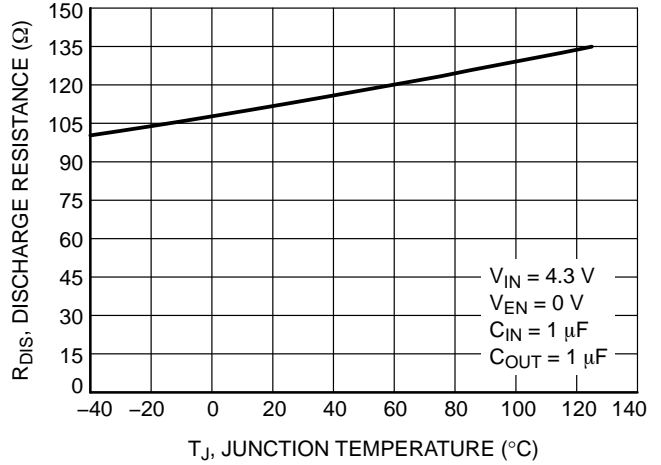

Figure 16. Discharge Resistance vs. Temperature

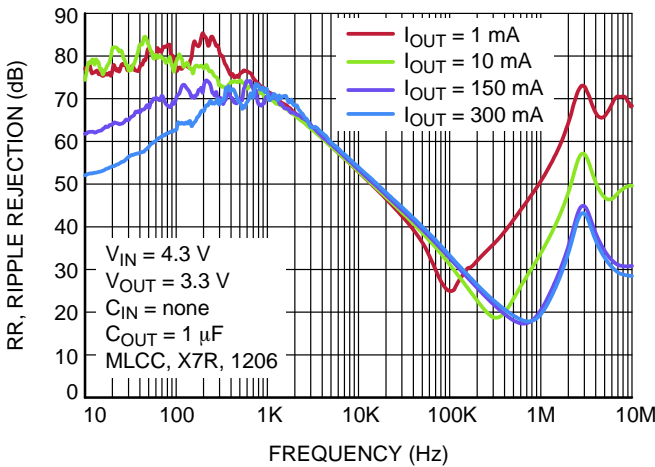

Figure 17. Power Supply Rejection Ratio – C<sub>OUT</sub> = 1 μF

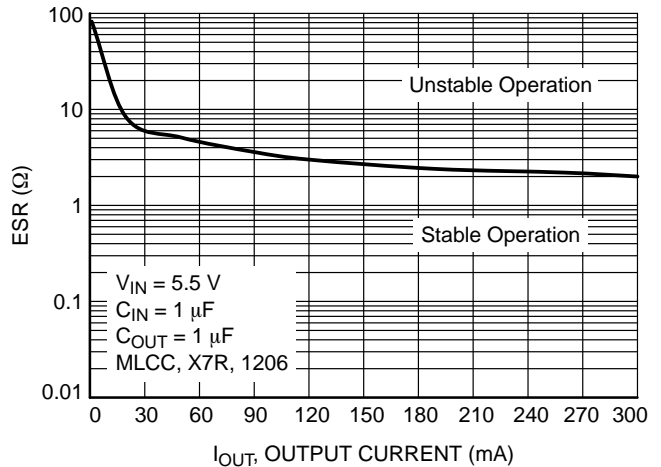

Figure 18. Output Capacitor ESR vs. Output Current

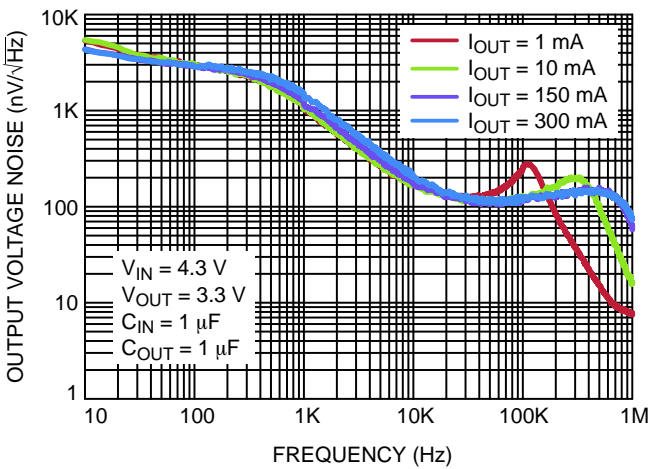

Figure 19. Output Voltage Noise Spectral Density – C<sub>OUT</sub> = 1 μF

I <sub>OUT</sub>	RMS Output Noise (μV)	
	10 Hz – 100 kHz	100 Hz – 100 kHz
1 mA	90.25	83.61
10 mA	84.55	77.23
150 mA	86.57	80.86
300 mA	95.36	90.17

TYPICAL CHARACTERISTICS

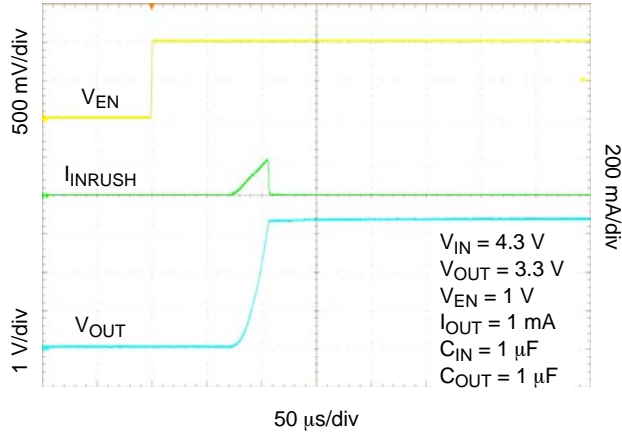

Figure 20. Enable Turn-on Response –  $C_{OUT} = 1 \mu F, I_{OUT} = 1 \text{ mA}$

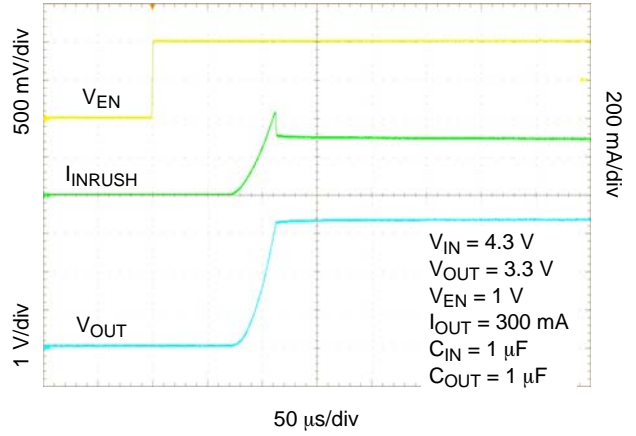

Figure 21. Enable Turn-on Response –  $C_{OUT} = 1 \mu F, I_{OUT} = 300 \text{ mA}$

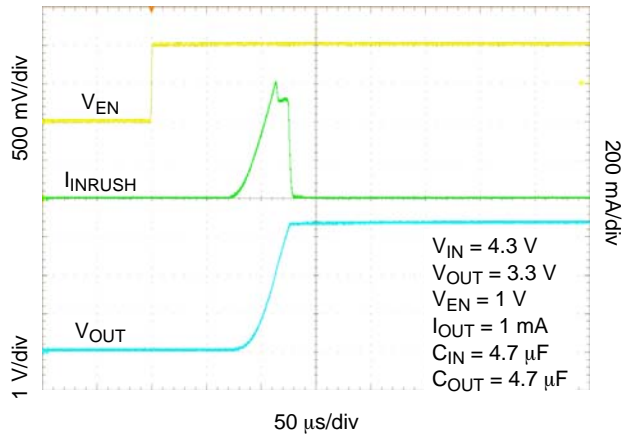

Figure 22. Enable Turn-on Response –  $C_{OUT} = 4.7 \mu F, I_{OUT} = 1 \text{ mA}$

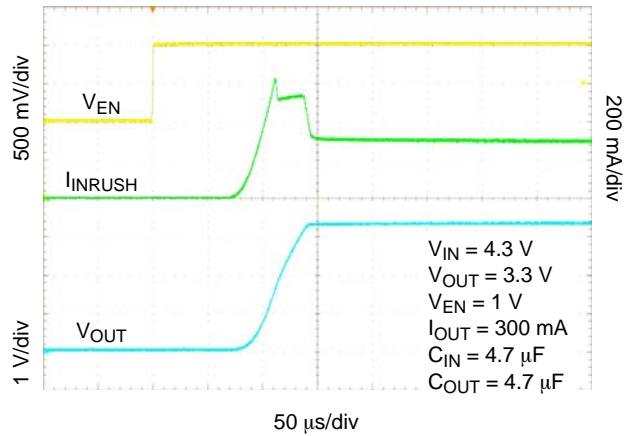

Figure 23. Enable Turn-on Response –  $C_{OUT} = 4.7 \mu F, I_{OUT} = 300 \text{ mA}$

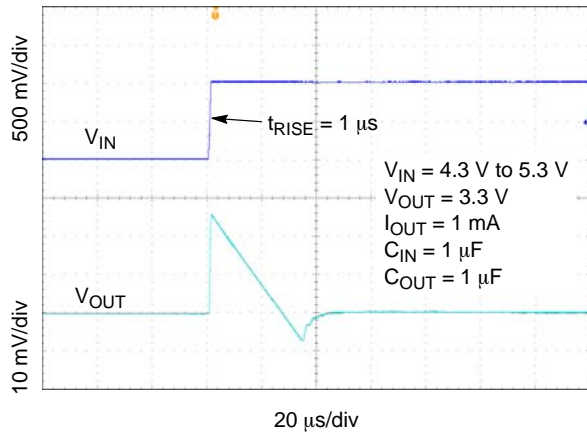

Figure 24. Line Transient Response – Rising Edge,  $I_{OUT} = 1 \text{ mA}$

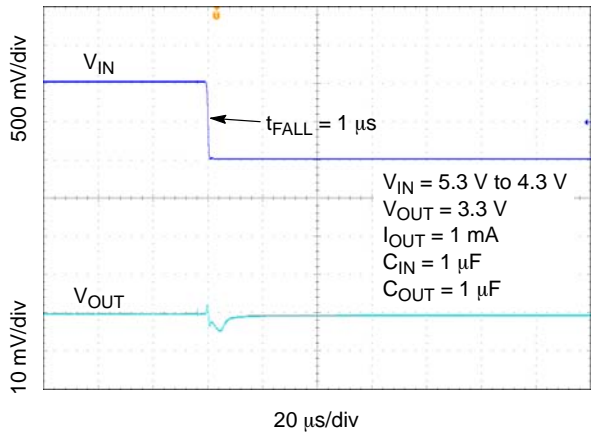

Figure 25. Line Transient Response – Falling Edge,  $I_{OUT} = 1 \text{ mA}$

TYPICAL CHARACTERISTICS

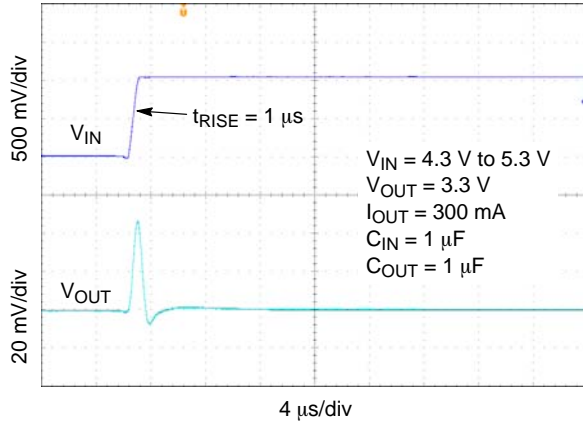

Figure 26. Line Transient Response – Rising Edge,  $I_{OUT} = 300 \text{ mA}$

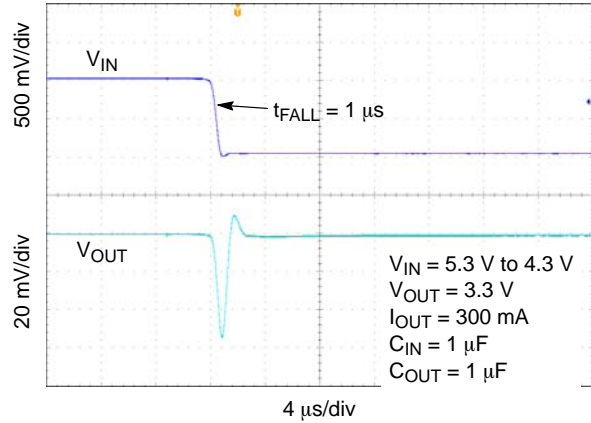

Figure 27. Line Transient Response – Falling Edge,  $I_{OUT} = 300 \text{ mA}$

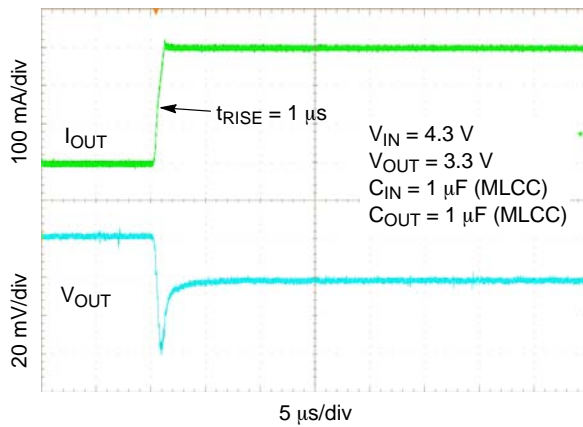

Figure 28. Load Transient Response – Rising Edge,  $V_{OUT} = 3.3 \text{ V}$ ,  $I_{OUT} = 1 \text{ mA}$  to  $300 \text{ mA}$

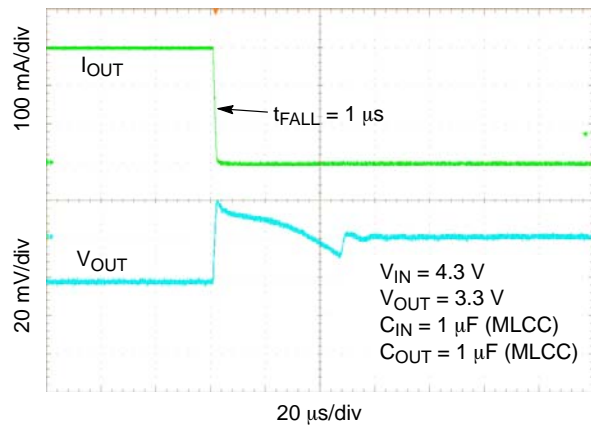

Figure 29. Load Transient Response – Falling Edge,  $V_{OUT} = 3.3 \text{ V}$ ,  $I_{OUT} = 1 \text{ mA}$  to  $300 \text{ mA}$

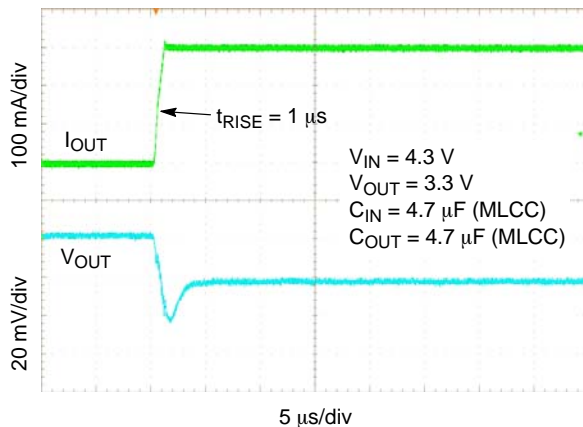

Figure 30. Load Transient Response – Rising Edge,  $V_{OUT} = 3.3 \text{ V}$ ,  $I_{OUT} = 1 \text{ mA}$  to  $300 \text{ mA}$

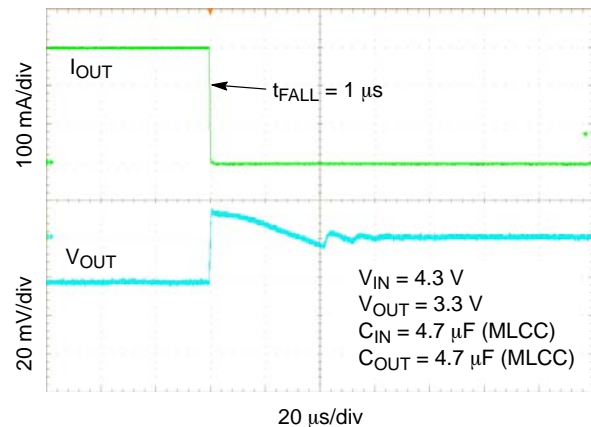

Figure 31. Load Transient Response – Falling Edge,  $V_{OUT} = 3.3 \text{ V}$ ,  $I_{OUT} = 1 \text{ mA}$  to  $300 \text{ mA}$



TYPICAL CHARACTERISTICS

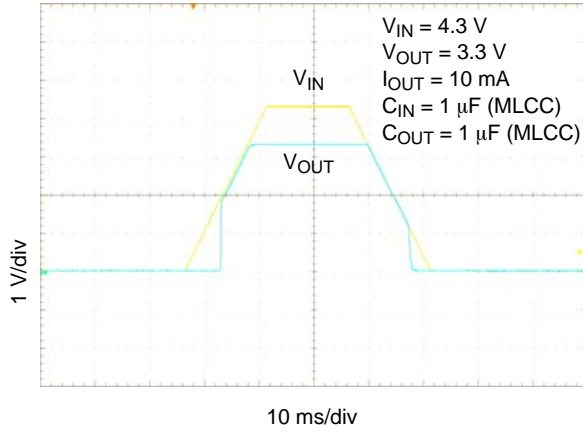

Figure 32. Turn-on/off – Slow Rising  $V_{IN}$

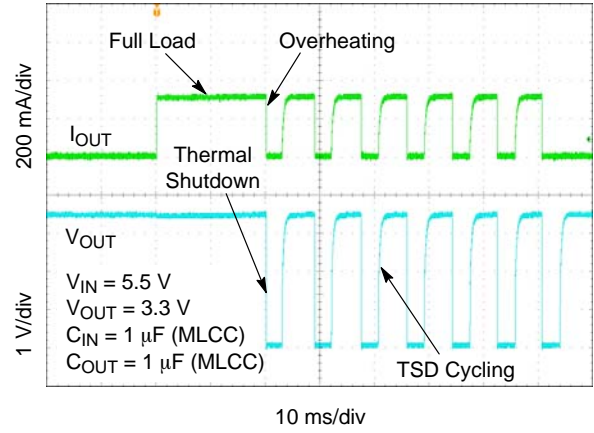

Figure 33. Short Circuit and Thermal Shutdown

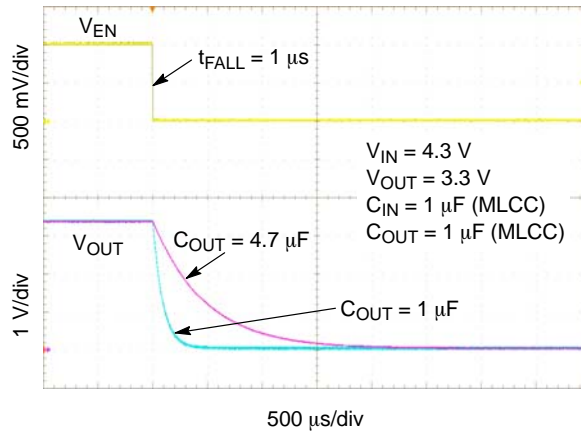

Figure 34. Enable Turn-off

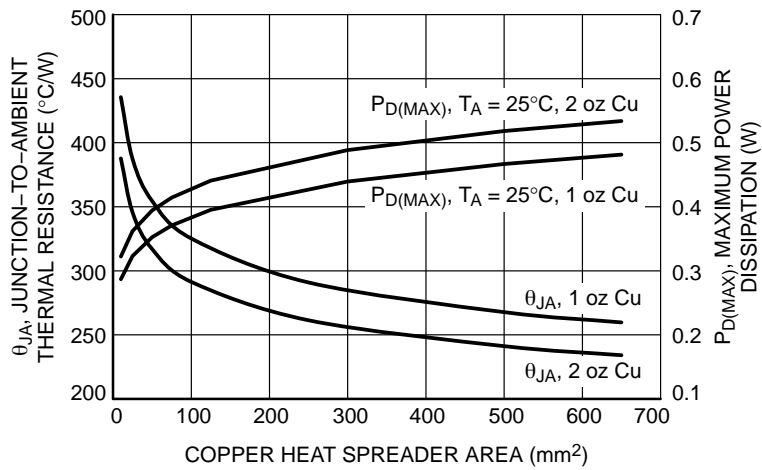

Figure 35.

APPLICATIONS INFORMATION

**General**

The NCV8114 is a high performance 300 mA Low Dropout Linear Regulator. This device delivers very high PSRR (over 75 dB at 1 kHz) and excellent dynamic performance as load/line transients. In connection with very low quiescent current this device is very suitable for various battery powered applications such as tablets, cellular phones, wireless and many others. The device is fully protected in case of output overload, output short circuit condition and overheating, assuring a very robust design.

**Input Capacitor Selection (C<sub>IN</sub>)**

It is recommended to connect at least a 1 µF Ceramic X5R or X7R capacitor as close as possible to the IN pin of the device. This capacitor will provide a low impedance path for unwanted AC signals or noise modulated onto constant input voltage. There is no requirement for the min. /max. ESR of the input capacitor but it is recommended to use ceramic capacitors for their low ESR and ESL. A good input capacitor will limit the influence of input trace inductance and source resistance during sudden load current changes. Larger input capacitor may be necessary if fast and large load transients are encountered in the application.

**Output Decoupling (C<sub>OUT</sub>)**

The NCV8114 requires an output capacitor connected as close as possible to the output pin of the regulator. The recommended capacitor value is 1 µF and X7R or X5R dielectric due to its low capacitance variations over the specified temperature range. The NCV8114 is designed to remain stable with minimum effective capacitance of 0.22µF to account for changes with temperature, DC bias and package size. Especially for small package size capacitors such as 0402 the effective capacitance drops rapidly with the applied DC bias.

There is no requirement for the minimum value of Equivalent Series Resistance (ESR) for the C<sub>OUT</sub> but the maximum value of ESR should be less than 2 Ω. Larger output capacitors and lower ESR could improve the load transient response or high frequency PSRR. It is not recommended to use tantalum capacitors on the output due to their large ESR. The equivalent series resistance of tantalum capacitors is also strongly dependent on the temperature, increasing at low temperature.

**Enable Operation**

The NCV8114 uses the EN pin to enable/disable its device and to deactivate/activate the active discharge function.

If the EN pin voltage is <0.4 V the device is guaranteed to be disabled. The pass transistor is turned-off so that there is virtually no current flow between the IN and OUT. The active discharge transistor is active so that the output voltage V<sub>OUT</sub> is pulled to GND through a 100 Ω resistor. In the

disable state the device consumes as low as typ. 10 nA from the V<sub>IN</sub>.

If the EN pin voltage >0.9 V the device is guaranteed to be enabled. The NCV8114 regulates the output voltage and the active discharge transistor is turned-off.

The EN pin has internal pull-down current source with typ. value of 300 nA which assures that the device is turned-off when the EN pin is not connected. In the case where the EN function isn't required the EN should be tied directly to IN.

**Output Current Limit**

Output Current is internally limited within the IC to a typical 600 mA. The NCV8114 will source this amount of current measured with a voltage drops on the 90% of the nominal V<sub>OUT</sub>. If the Output Voltage is directly shorted to ground (V<sub>OUT</sub> = 0 V), the short circuit protection will limit the output current to 630 mA (typ). The current limit and short circuit protection will work properly over whole temperature range and also input voltage range. There is no limitation for the short circuit duration.

**Thermal Shutdown**

When the die temperature exceeds the Thermal Shutdown threshold (T<sub>SD</sub> – 160°C typical), Thermal Shutdown event is detected and the device is disabled. The IC will remain in this state until the die temperature decreases below the Thermal Shutdown Reset threshold (T<sub>SDU</sub> – 140°C typical). Once the IC temperature falls below the 140°C the LDO is enabled again. The thermal shutdown feature provides the protection from a catastrophic device failure due to accidental overheating. This protection is not intended to be used as a substitute for proper heat sinking.

**Power Dissipation**

As power dissipated in the NCV8114 increases, it might become necessary to provide some thermal relief. The maximum power dissipation supported by the device is dependent upon board design and layout. Mounting pad configuration on the PCB, the board material, and the ambient temperature affect the rate of junction temperature rise for the part. For reliable operation, junction temperature should be limited to +125°C.

The maximum power dissipation the NCV8114 can handle is given by:

$$P_{D(MAX)} = \frac{[125^{\circ}C - T_A]}{\theta_{JA}} \quad (\text{eq. 1})$$

The power dissipated by the NCV8114 for given application conditions can be calculated from the following equations:

$$P_D \approx V_{IN}(I_{GND}@I_{OUT}) + I_{OUT}(V_{IN} - V_{OUT}) \quad (\text{eq. 2})$$

# NCV8114

## Reverse Current

The PMOS pass transistor has an inherent body diode which will be forward biased in the case that  $V_{OUT} > V_{IN}$ . Due to this fact in cases, where the extended reverse current condition can be anticipated the device may require additional external protection.

## Power Supply Rejection Ratio

The NCV8114 features very good Power Supply Rejection ratio. If desired the PSRR at higher frequencies in the range 100 kHz – 10 MHz can be tuned by the selection of  $C_{OUT}$  capacitor and proper PCB layout.

## Turn-On Time

The turn-on time is defined as the time period from EN assertion to the point in which  $V_{OUT}$  will reach 98% of its

nominal value. This time is dependent on various application conditions such as  $V_{OUT(NOM)}$ ,  $C_{OUT}$  and  $T_A$ . For example typical value for  $V_{OUT} = 1.2$  V,  $C_{OUT} = 1$   $\mu$ F,  $I_{OUT} = 1$  mA and  $T_A = 25^\circ$ C is 90  $\mu$ s.

## PCB Layout Recommendations

To obtain good transient performance and good regulation characteristics place  $C_{IN}$  and  $C_{OUT}$  capacitors close to the device pins and make the PCB traces wide. In order to minimize the solution size, use 0402 capacitors. Larger copper area connected to the pins will also improve the device thermal resistance. The actual power dissipation can be calculated from the equation above (Equation 2). Expose pad should be tied the shortest path to the GND pin.

## ORDERING INFORMATION

Device	Voltage Option	Marking	Option	Package	Shipping <sup>†</sup>		
NCV8114ASN120T1G	1.2 V	DEC	With output active discharge function	TSOP-5 (Pb-Free)	3000 / Tape & Reel (Contact sales office for availability)		
NCV8114ASN150T1G	1.5 V	DED					
NCV8114ASN180T1G	1.8 V	DEE					
NCV8114ASN250T1G	2.5 V	DEH					
NCV8114ASN280T1G	2.8 V	DEF					
NCV8114ASN300T1G	3.0 V	DEG					
NCV8114ASN330T1G	3.3 V	DEA					
NCV8114BSN120T1G	1.2 V	DFC	Without output active discharge function			TSOP-5 (Pb-Free)	3000 / Tape & Reel (Contact sales office for availability)
NCV8114BSN150T1G	1.5 V	DFD					
NCV8114BSN180T1G	1.8 V	DFE					
NCV8114BSN280T1G	2.8 V	DFF					
NCV8114BSN300T1G	3.0 V	DFG					
NCV8114BSN330T1G	3.3 V	DFA					

<sup>†</sup>For information on tape and reel specifications, including part orientation and tape sizes, please refer to our Tape and Reel Packaging Specifications Brochure, BRD8011/D.

# NCV8114

## PACKAGE DIMENSIONS

### TSOP-5 CASE 483 ISSUE M

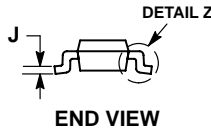
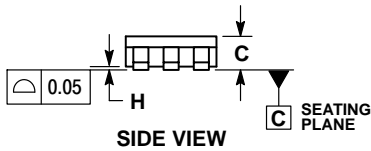
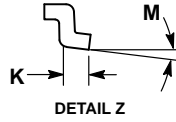
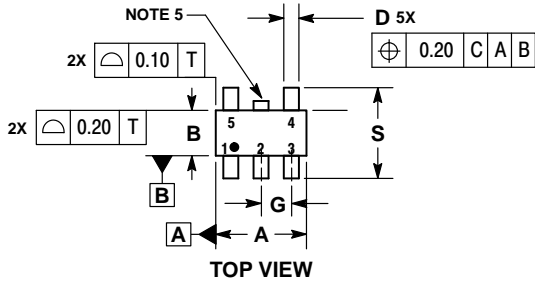

#### NOTES:

1. DIMENSIONING AND TOLERANCING PER ASME Y14.5M, 1994.
2. CONTROLLING DIMENSION: MILLIMETERS.
3. MAXIMUM LEAD THICKNESS INCLUDES LEAD FINISH THICKNESS. MINIMUM LEAD THICKNESS IS THE MINIMUM THICKNESS OF BASE MATERIAL.
4. DIMENSIONS A AND B DO NOT INCLUDE MOLD FLASH, PROTRUSIONS, OR GATE BURRS. MOLD FLASH, PROTRUSIONS, OR GATE BURRS SHALL NOT EXCEED 0.15 PER SIDE. DIMENSION A.
5. OPTIONAL CONSTRUCTION: AN ADDITIONAL TRIMMED LEAD IS ALLOWED IN THIS LOCATION. TRIMMED LEAD NOT TO EXTEND MORE THAN 0.2 FROM BODY.

MILLIMETERS		
DIM	MIN	MAX
A	2.85	3.15
B	1.35	1.65
C	0.90	1.10
D	0.25	0.50
G	0.95 BSC	
H	0.01	0.10
J	0.10	0.26
K	0.20	0.60
M	0° 10°	
S	2.50	3.00

#### SOLDERING FOOTPRINT\*

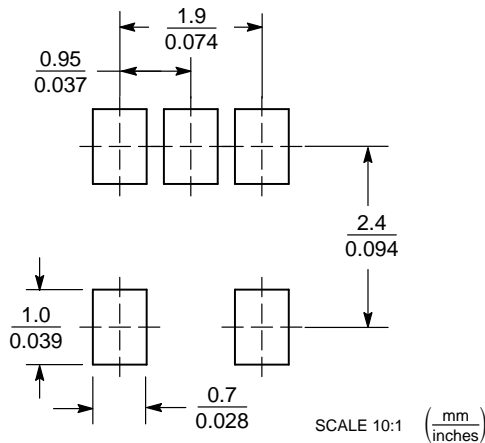

\*For additional information on our Pb-Free strategy and soldering details, please download the ON Semiconductor Soldering and Mounting Techniques Reference Manual, SOLDERRM/D.

Bluetooth is a registered trademark of Bluetooth SIG.

ZigBee is a registered trademark of ZigBee Alliance.

ON Semiconductor and are trademarks of Semiconductor Components Industries, LLC dba ON Semiconductor or its subsidiaries in the United States and/or other countries. ON Semiconductor owns the rights to a number of patents, trademarks, copyrights, trade secrets, and other intellectual property. A listing of ON Semiconductor's product/patent coverage may be accessed at [www.onsemi.com/site/pdf/Patent-Marking.pdf](http://www.onsemi.com/site/pdf/Patent-Marking.pdf). ON Semiconductor reserves the right to make changes without further notice to any products herein. ON Semiconductor makes no warranty, representation or guarantee regarding the suitability of its products for any particular purpose, nor does ON Semiconductor assume any liability arising out of the application or use of any product or circuit, and specifically disclaims any and all liability, including without limitation special, consequential or incidental damages. Buyer is responsible for its products and applications using ON Semiconductor products, including compliance with all laws, regulations and safety requirements or standards, regardless of any support or applications information provided by ON Semiconductor. "Typical" parameters which may be provided in ON Semiconductor data sheets and/or specifications can and do vary in different applications and actual performance may vary over time. All operating parameters, including "Typicals" must be validated for each customer application by customer's technical experts. ON Semiconductor does not convey any license under its patent rights nor the rights of others. ON Semiconductor products are not designed, intended, or authorized for use as a critical component in life support systems or any FDA Class 3 medical devices or medical devices with a same or similar classification in a foreign jurisdiction or any devices intended for implantation in the human body. Should Buyer purchase or use ON Semiconductor products for any such unintended or unauthorized application, Buyer shall indemnify and hold ON Semiconductor and its officers, employees, subsidiaries, affiliates, and distributors harmless against all claims, costs, damages, and expenses, and reasonable attorney fees arising out of, directly or indirectly, any claim of personal injury or death associated with such unintended or unauthorized use, even if such claim alleges that ON Semiconductor was negligent regarding the design or manufacture of the part. ON Semiconductor is an Equal Opportunity/Affirmative Action Employer. This literature is subject to all applicable copyright laws and is not for resale in any manner.

#### PUBLICATION ORDERING INFORMATION

##### LITERATURE FULFILLMENT:

Literature Distribution Center for ON Semiconductor  
19521 E. 32nd Pkwy, Aurora, Colorado 80011 USA  
Phone: 303-675-2175 or 800-344-3860 Toll Free USA/Canada  
Fax: 303-675-2176 or 800-344-3867 Toll Free USA/Canada  
Email: [orderlit@onsemi.com](mailto:orderlit@onsemi.com)

**N. American Technical Support:** 800-282-9855 Toll Free  
USA/Canada  
**Europe, Middle East and Africa Technical Support:**  
Phone: 421 33 790 2910  
**Japan Customer Focus Center**  
Phone: 81-3-5817-1050

**ON Semiconductor Website:** [www.onsemi.com](http://www.onsemi.com)

**Order Literature:** <http://www.onsemi.com/orderlit>

For additional information, please contact your local Sales Representative