

ESD56241DXX
1-Line, Uni-directional, Transient Voltage Suppressor
<http://www.sh-willsemi.com>
Descriptions

The ESD56241DXX is a transient voltage suppressor designed to protect power interfaces. It is suitable to replace multiple discrete components in portable electronics.

The ESD56241DXX is specifically designed to protect USB port. TVS diode with higher surge capability is used to protect USB voltage bus pin.

The ESD56241DXX is available in DFN2×2-3L package. Standard products are Pb-free and Halogen-free.

Features

- Reverse stand-off voltage: 7.5V ~ 22V
- Surge protection according to IEC61000-4-5
8/20μs waveform: I_{PPM} see [Table 4](#)
- Low clamping voltage
- Solid-state silicon technology

Applications

- Power supply protection
- Power management

Order information

Table 1.

Device	Package	Shipping	Device code
ESD56241D07-3/TR	DFN2×2-3L	3000/Tape&Reel	07
ESD56241D10-3/TR	DFN2×2-3L	3000/Tape&Reel	10
ESD56241D12-3/TR	DFN2×2-3L	3000/Tape&Reel	12
ESD56241D15-3/TR	DFN2×2-3L	3000/Tape&Reel	15
ESD56241D18-3/TR	DFN2×2-3L	3000/Tape&Reel	18
ESD56241D20-3/TR	DFN2×2-3L	3000/Tape&Reel	20
ESD56241D22-3/TR	DFN2×2-3L	3000/Tape&Reel	22

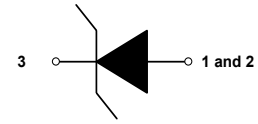
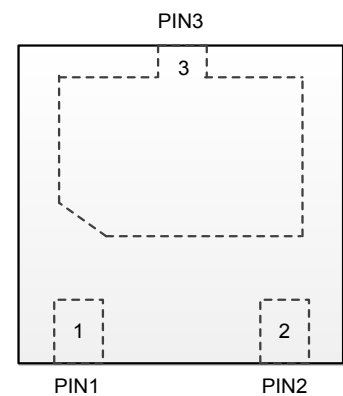
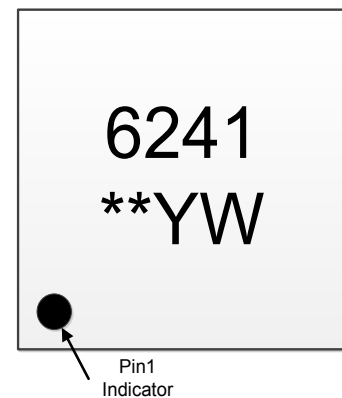
Circuit diagram

Pin configuration (Top View)

6241 = Series code
 ** = Device code
 YW = Date code

Marking

Absolute maximum ratings
Table 2.

Parameter	Symbol	Rating	Unit
Peak pulse power ($t_p=8/20\mu s$) ¹⁾²⁾	P_{PK}	4500	W
ESD according to IEC61000-4-2 air discharge	V_{ESD}	± 30	kV
ESD according to IEC61000-4-2 contact discharge		± 30	
Junction temperature	T_J	125	$^{\circ}C$
Operating temperature	T_{OP}	-40~85	$^{\circ}C$
Lead temperature	T_L	260	$^{\circ}C$
Storage temperature	T_{STG}	-55~150	$^{\circ}C$

Notes:

- 1) Non-repetitive current pulse, according to IEC61000-4-5.(8/20 μs current waveform)
- 2) Measured from pin 3 to pin 1 and pin 2.

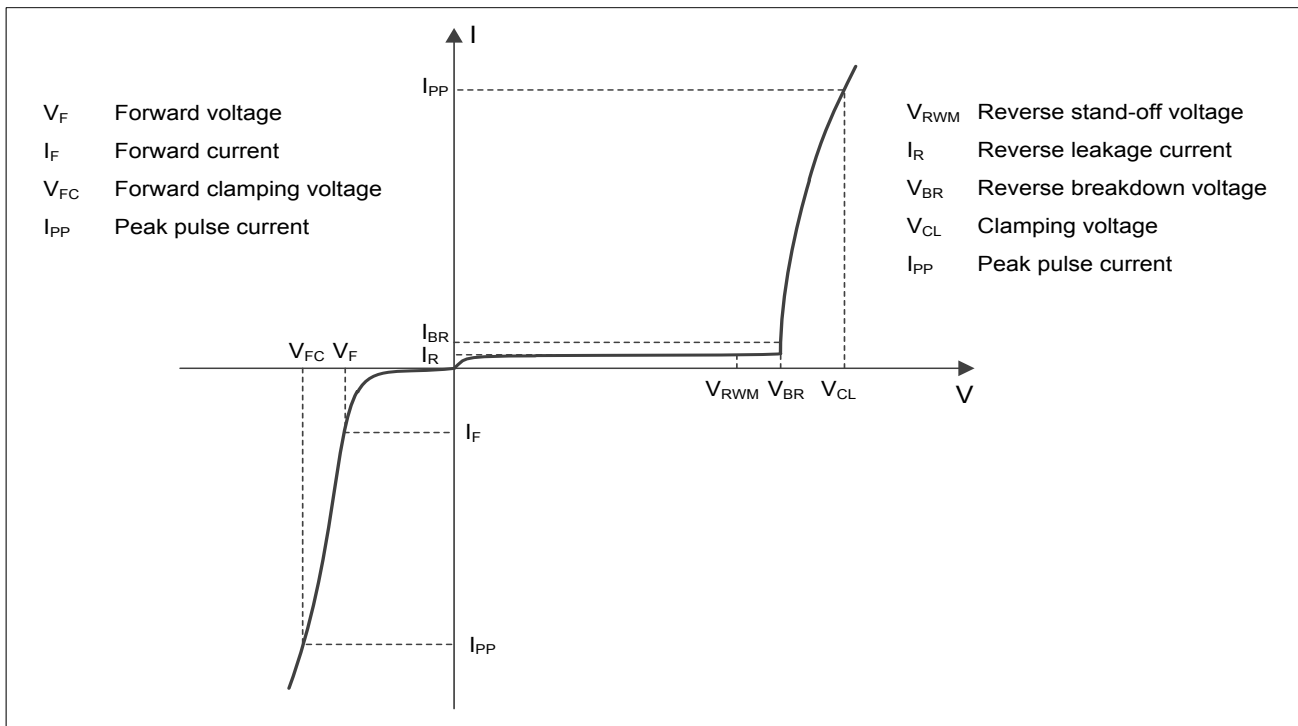
Electrical characteristics ($T_A = 25^{\circ}C$, unless otherwise noted)

Definitions of electrical characteristics

Electrical characteristics ($T_A = 25^\circ\text{C}$, unless otherwise noted)
Table 3.

Type number	Reverse Standoff Voltage V_{RWM} (V)	Breakdown voltage V_{BR} (V) $I_{BR} = 1\text{mA}$			Reverse leakage current I_{RM} (nA) at V_{RWM}		Forward voltage V_F (V) $I_F = 20\text{mA}$		Junction capacitance $F=1\text{MHz}$, $V_R=0\text{V}$ (pF)	
	Max.	Min.	Typ.	Max.	Typ.	Max.	Min.	Max.	Typ.	Max.
ESD56241D07	7.5	8.5	9.3	10.0	-	1000	0.45	1.25	2750	3300
ESD56241D10	10.0	10.7	11.6	12.5	-	1000	0.45	1.25	2150	2600
ESD56241D12	12.0	12.8	13.9	15.0	-	100	0.45	1.25	1650	2000
ESD56241D15	15.0	16.0	17.3	18.6	-	100	0.45	1.25	1250	1500
ESD56241D18	18.0	19.2	21.1	23.0		100	0.45	1.25	1050	1150
ESD56241D20	20.0	21.4	23.2	25.0		100	0.45	1.25	950	1050
ESD56241D22	22.0	23.5	25	26.5	-	100	0.45	1.25	900	1000

Table 4.

Type number	Rated peak pulse current I_{PP} (A) ¹⁾²⁾	Clamping voltage V_{CL} (V) at I_{PP} (A) ¹⁾²⁾	
	Max.	Typ.	Max.
ESD56241D07	240	16	19
ESD56241D10	205	19	22
ESD56241D12	200	22	25
ESD56241D15	160	26	30
ESD56241D18	150	31	34
ESD56241D20	140	33	36
ESD56241D22	130	35	38

Notes:

- 1) Non-repetitive current pulse, according to IEC61000-4-5. (8/20 μs current waveform)
- 2) Measured from pin 3 to pin 1 and pin 2.

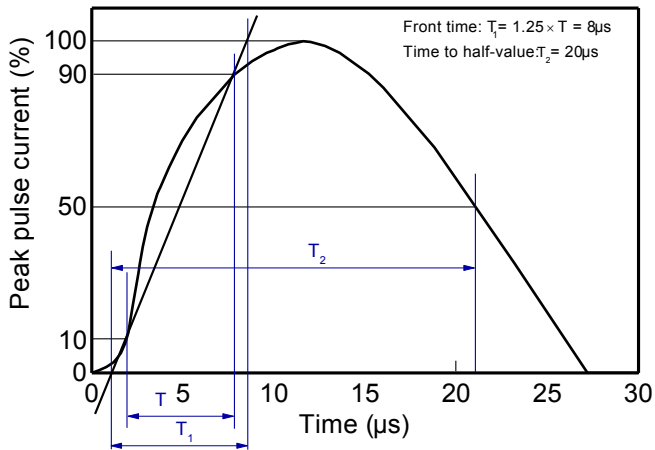
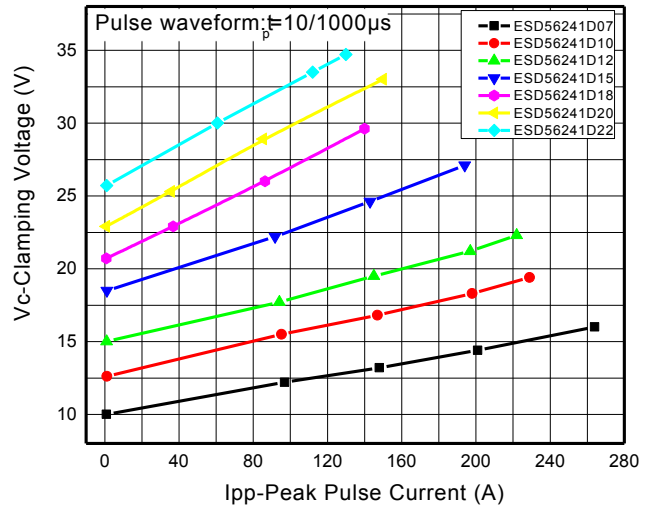
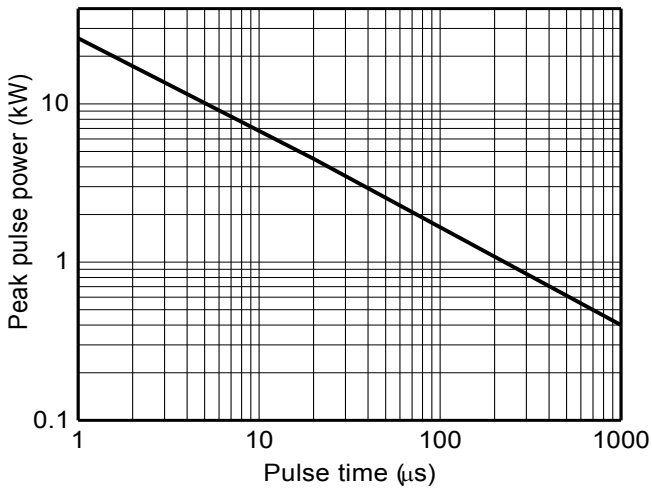
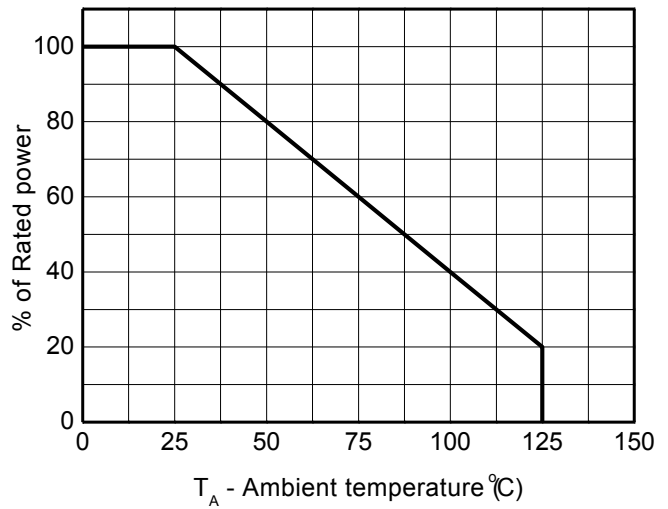
Typical characteristics ($T_A = 25^\circ\text{C}$, unless otherwise noted)

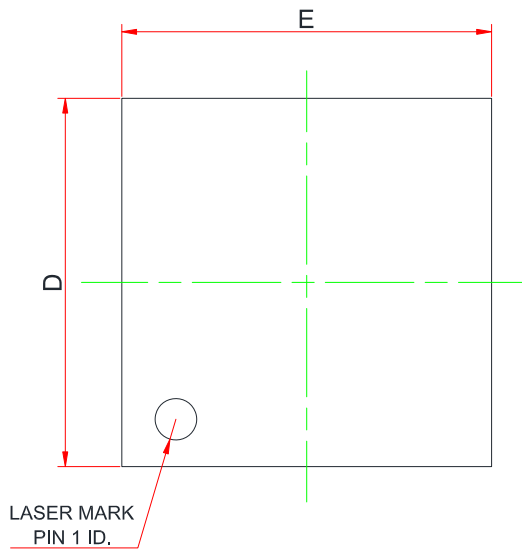
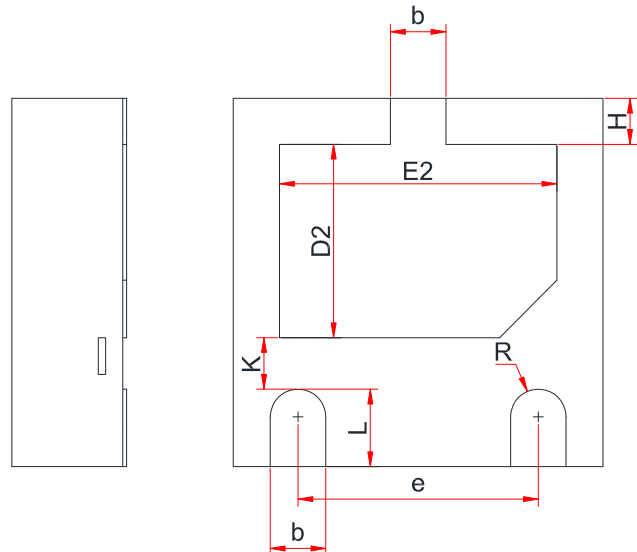
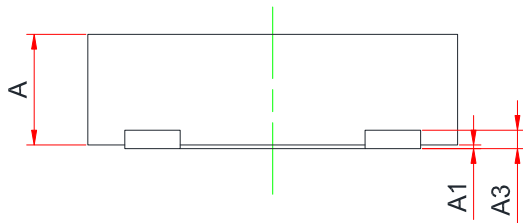
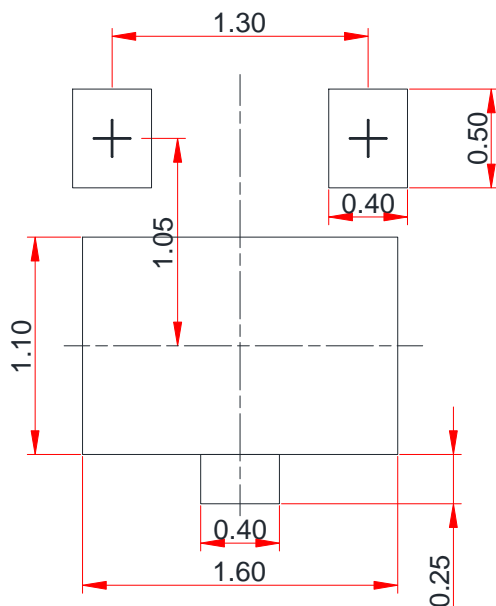
8/20 μs waveform per IEC61000-4-5

Clamping voltage vs. Peak pulse current

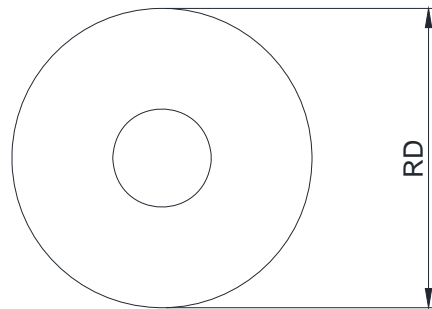
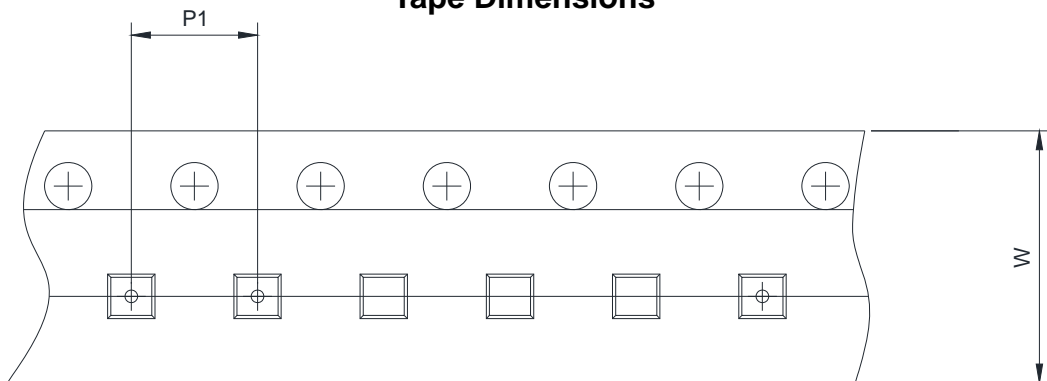
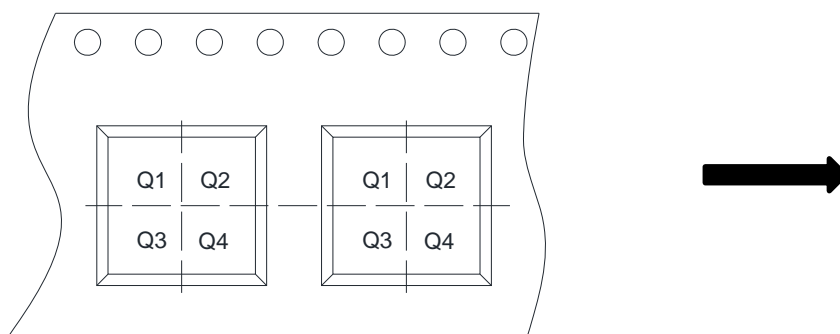
Non-repetitive peak pulse power vs. Pulse time

Power derating vs. Ambient temperature

Package outline dimensions
DFN2x2-3L

Top View

Bottom View

Side View
Recommended land pattern (Unit: mm)

Symbol	Dimensions In Millimeters		
	Min.	Typ.	Max.
A	0.55	0.60	0.65
A1	0.00	0.02	0.05
A3	0.10 REF.		
b	0.25	0.30	0.35
D	1.90	2.00	2.10
E	1.90	2.00	2.10
D2	0.95	1.05	1.15
E2	1.40	1.50	1.60
e	1.20	1.30	1.40
H	0.20	0.25	0.30
K	0.20	0.30	0.40
L	0.35	0.40	0.45
R	0.13	-	-

TAPE AND REEL INFORMATION
Reel Dimensions

Tape Dimensions

Quadrant Assignments For PIN1 Orientation In Tape

RD	Reel Dimension	<input checked="" type="checkbox"/> 7inch	<input type="checkbox"/> 13inch		
W	Overall width of the carrier tape	<input checked="" type="checkbox"/> 8mm	<input type="checkbox"/> 12mm		
P1	Pitch between successive cavity centers	<input type="checkbox"/> 2mm	<input checked="" type="checkbox"/> 4mm	<input type="checkbox"/> 8mm	
Pin1	Pin1 Quadrant	<input type="checkbox"/> Q1	<input checked="" type="checkbox"/> Q2	<input type="checkbox"/> Q3	<input type="checkbox"/> Q4