



# Application Note: SY8751

## High Efficiency, 5-80V Input, 500kHz White LED Driver Preliminary Specification

### General Description

SY8751 is a high efficiency, 5V-80V wide input voltage range DC/DC regulator targeting at LED applications. The device integrates the low  $R_{DS(ON)}$  MOSFET and internal compensation. SY8751 supports analog dimming with PWM signal/Analog signal.

### Features

- Wide input range: 5-80 V
- 500kHz switching frequency
- Integrated low  $R_{DS(ON)}$  FET
- Analog dimming with PWM signal/Analog signal
- Maximum output LED current 1.2A
- Compact package: SO8E

### Ordering Information

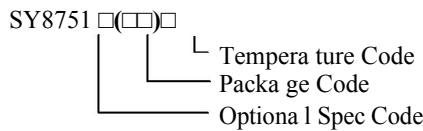

Ordering Number	Package type	Note
SY8751FCC	SO8E	----

### Applications

- LED lighting

### Typical Applications

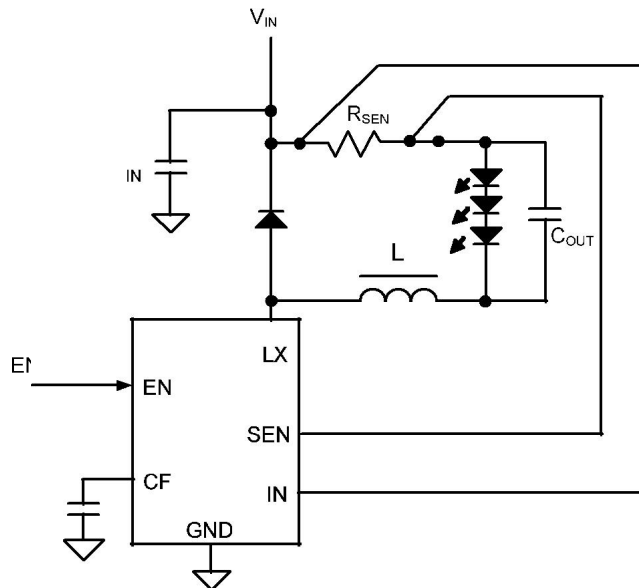
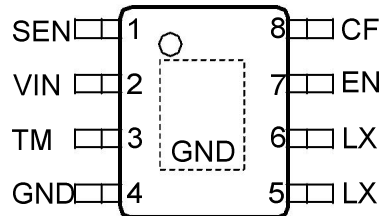

Figure 1. Schematic diagram

## Pinout (top view)



SO8E

Top Mark: BJAxyz (device code: BJA, x=year code, y=week code, z=lot number code)

Pin Name	S08E	Pin Description
SEN	1	Negative Current Sense Pin.
IN	2	Input pin. Decouple this pin to GND pin with 1uF ceramic cap. Also used as the positive current sense pin.
TM	3	Connect to GND
GND	4	Ground pin
LX	5,6	Inductor node.
EN	7	Enable pin and PWM dimming input pin.
CF	8	Connect a capacitor from this pin to ground to filter out the AC ripple on reference voltage. Or add 0~1.1V on this pin directly to realize linear dimming.

## Block Diagram

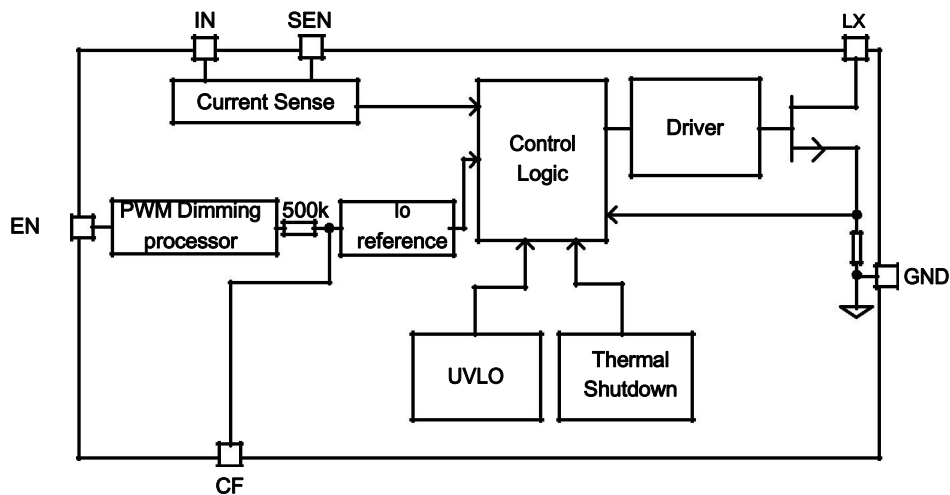



**Absolute Maximum Ratings**

IX, IX, EN	90V
SEN	$V_{IN} \pm 0.6V$
CF	5V
Power Dissipation, PD @ $T_A = 25^\circ C$ SO8E	3.3W
Package Thermal Resistance (Note 2)	30°C/W
	10°C/W
Junction Temperature Range	-40°C to 150°C
Lead Temperature (Soldering, 10 sec.)	260°C
Storage Temperature Range	-65°C to 150°C

**Recommended Operating Conditions**

IX, IX, EN	5V to 80V
SEN	$V_{IN} \pm 0.4V$
CF	0-2.0V
Junction Temperature Range	-40°C to 150°C

**Electrical Characteristics**

( $V_{IN} = 80V$ ,  $V_{OUT} = 70V$ ,  $I_{OUT} = 0.6A$ ,  $T_A = 25^\circ C$  unless otherwise specified)

Parameter	Symbol	Test Conditions	Min	Typ	Max	Unit
Input Voltage Range	$V_{IN}$		5		90	V
Shutdown Current	$I_{SHDN}$	EN=0		10		$\mu A$
Switching Frequency	$F_{SW}$			500		kHz
Current Sense Limit	$V_{IN-SEN}$		196	200	204	mV
Main FET Current Limit	$I_{LIM}$			1.8		A
EN Rising Threshold	$V_{ENH}$			1.25		V
EN Falling Threshold	$V_{ENL}$			1.05		V
IN UVLO Rising Threshold	$V_{IN\_UVLO}$			4.4		V
UVLO Hysteresis	$U_{VLO\_HYS}$			1.25		V
Dimming section:						
Analog dimming range on CF	$V_{CF}$	$I_{LED}$ is 5.7% of full load		62.5		mV
		$I_{LED}$ is 100% of full load		1.1		V
Thermal Shutdown Temperature	$T_{SD}$			150		$^\circ C$
Thermal Hysteresis	Hyst			15		$^\circ C$

**Note 1:** Stresses beyond the “Absolute Maximum Ratings” may cause permanent damage to the device. These are stress ratings only. Functional operation of the device at these or any other conditions beyond those indicated in the operational sections of the specification is not implied. Exposure to absolute maximum rating conditions for extended periods may affect device reliability.

**Note 2:**  $\theta_{JA}$  is measured in the natural convection at  $T_A = 25^\circ C$  on a low effective single layer thermal conductivity test board of JEDEC 51-3 thermal measurement standard.

**Note 3:** The device is not guaranteed to function outside its operating conditions.

## Typical Performance Characteristics

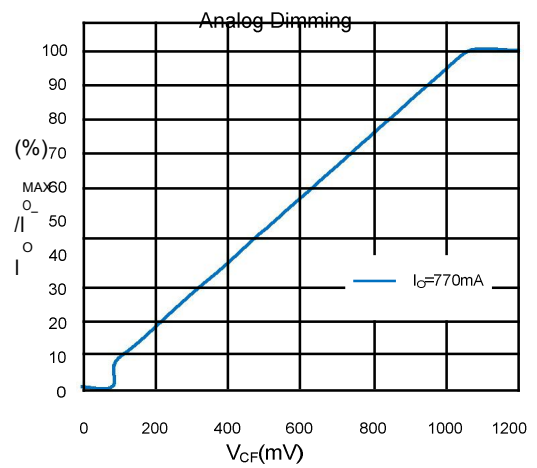
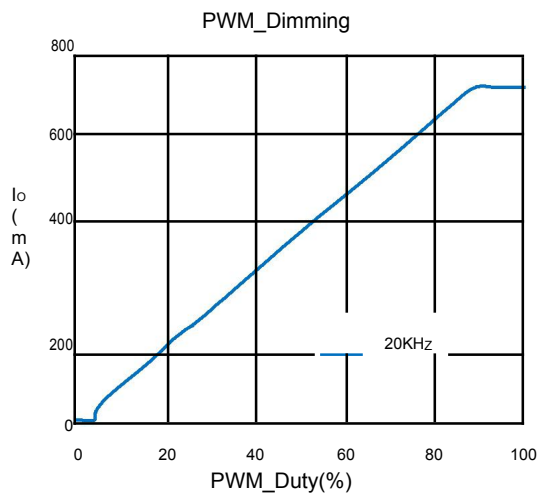
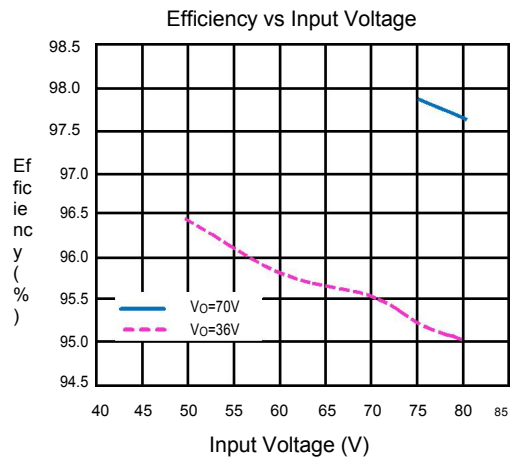

## Operation

SY8751 is a grounded-switch buck regulator that integrates controller, power MOSFET on the same die.

With ultra low RDS(ON) power switches and proprietary PWM control, this regulator can achieve the high efficiency. SY8751 also supports analog dimming function with both PWM and analog dimming signals.

## Applications Information

Because of the high integration in the SY8751, the application circuit based on this regulator is rather simple. The design of external components' parameter as below:

### Schottky diode:

Select according to input voltage and output current.

### Current sense resistor R<sub>SEN</sub>:

Choose R<sub>SEN</sub> to program the proper output Current:

$$I_{LED(A)} = \frac{0.2(V)}{R_{SEN}(\Omega)}$$

### Input capacitor C<sub>IN</sub>:

The ripple current through input capacitor is calculated as:

$$I_{CIN\_RMS} = I_{OUT} \cdot \sqrt{D(1-D)}$$

A typical X7R or better grade ceramic capacitor with suitable capacitance should be chosen to handle this ripple current well. To minimize the potential noise problem, this ceramic capacitor should be placed really close to IN and GND. The loop area, formed by C<sub>IN</sub>, and IN/GND pins, should be minimized to achieve better EMI performance.

### Output capacitor C<sub>OUT</sub>:

The output capacitor is selected to handle the output current ripple. For the best performance, it is recommended to use X7R or better grade ceramic capacitor greater than 1uF capacitance.

### Output inductor L:

There are several considerations in choosing this inductor.

- 1) Choose the inductance to provide the desired ripple current. It is suggested to choose the ripple current to be about 40% of the maximum output current. The inductance is calculated as:

$$L = \frac{V_{OUT} (1 - V_{OUT} / V_{IN,MAX})}{F_{SW} \times I_{OUT,MAX} \times 40\%}$$

where F<sub>sw</sub> is the switching frequency and I<sub>OUT,MAX</sub> is the LED current.

SY8751 is quite tolerant of different ripple current amplitude. Consequently, the final choice of inductance can be slightly off the calculation value without significantly impacting the performance.

- 2) The saturation current rating of the inductor must be selected to be greater than the peak inductor current under full load conditions.

$$I_{SAT, MIN} > I_{OUT, MAX} + \frac{V_{OUT} (1 - V_{OUT} / V_{IN, MAX})}{2 \cdot F_{SW} \cdot L}$$

### Dimming Operation:

It is compatible with two dimming signals: PWM signal and analog signal.

Applied with PWM signal, the PWM is connected to EN pin, the dimming frequency is limited to larger than 20kHz. If the dimming frequency is lower than 20kHz, an external capacitor is needed to bypass CF pin.

Applied with analog dimming, EN pin is pulled up to high, and the analog signal 0-1.1V is connected to CF pin.

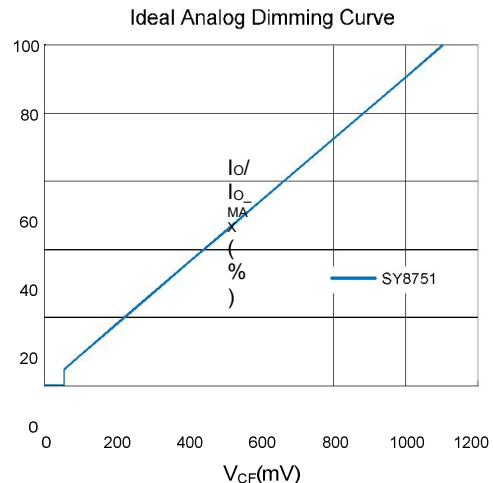

### Soft Start:

Add a ceramic capacitor C<sub>F</sub> on CF to achieve soft start, the soft start time can be adjusted by C<sub>F</sub>.

### SCP:

If V<sub>VIN</sub>-V<sub>SEN</sub> ≥ 0.6V, the output is disabled.

### EN OFF:

If V<sub>EN</sub> is lower than V<sub>ENL</sub>, IC will shut down after 11ms.

**Layout Design:**

The layout design of SY8751 is relatively simple. For the best efficiency and minimum noise problems, we should place the following components close to the IC:  $C_{IN}$ , L,  $C_{OUT}$ ,  $C_F$  and  $R_{SEN}$ .

1) It is desirable to maximize the PCB copper area connecting to GND pin to achieve the best thermal and

noise performance. If the board space allowed, a ground plane is highly desirable.

2)  $C_{IN}$  must be close to Pins IN and GND. The loop area formed by  $C_{IN}$  and GND must be minimized.

3) The PCB copper area associated with LX pin must be minimized to avoid the potential noise problem.

**PCB Layout Suggestion**

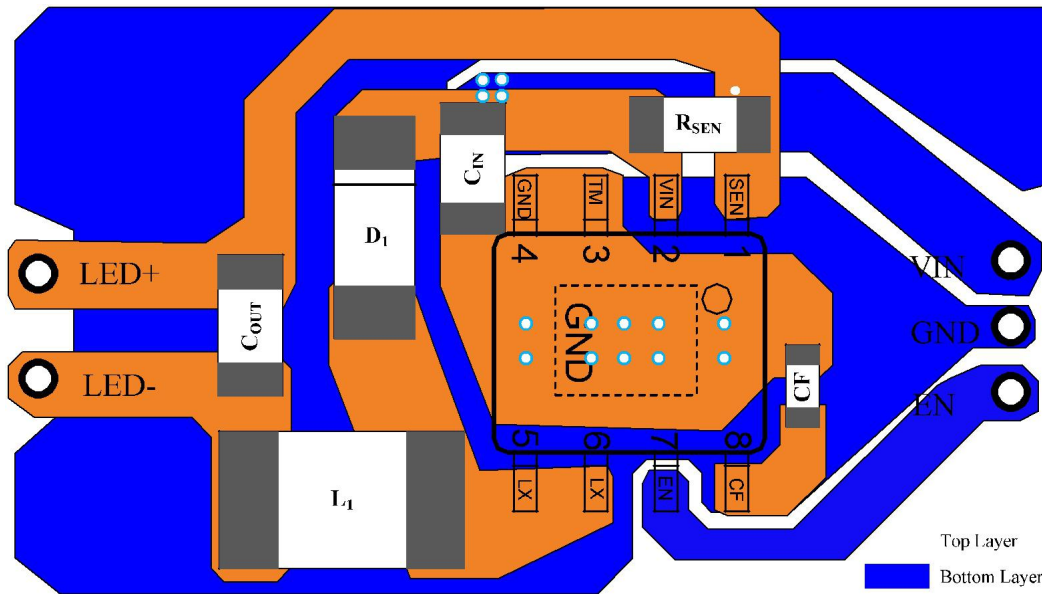

**SO8E Package Outline & PCB layout**

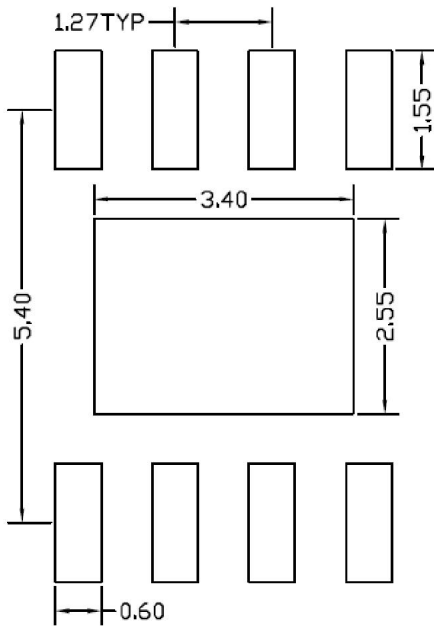

**Recommended Pad Layout**

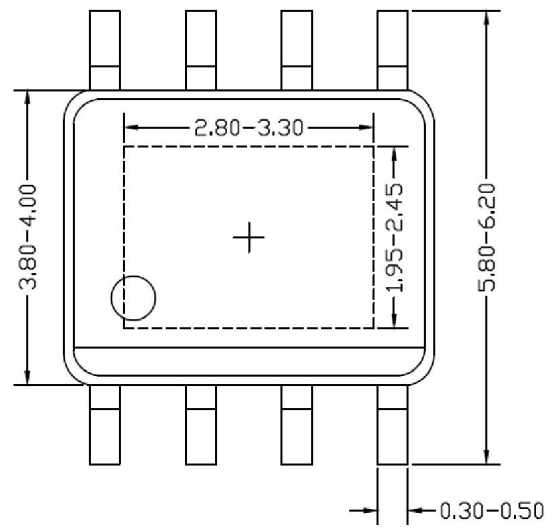

**Top view**

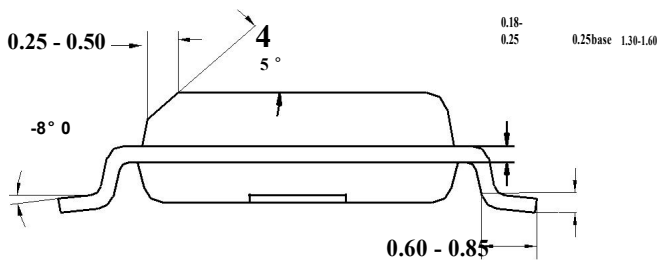

**Side view**

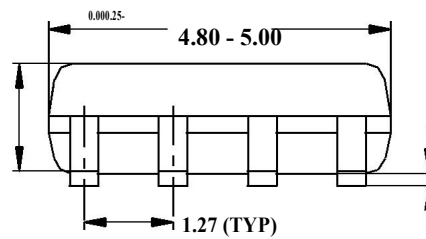

**Notes:** All dimension in millimeter  
All dimension don't include mold flash & metal burr

**Taping & Reel Specification**

**1. SO8E**

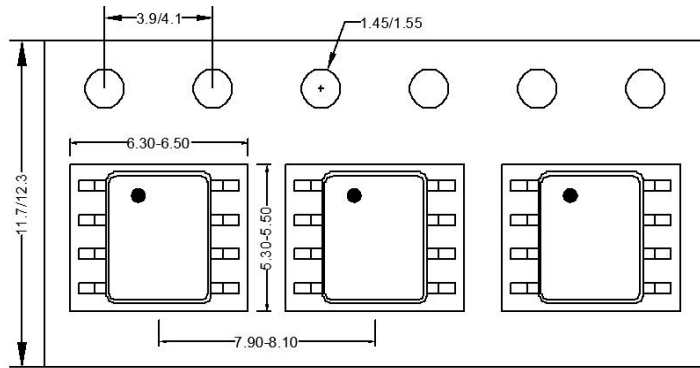

Feeding direction →

**2. Carrier Tape & Reel specification for packages**

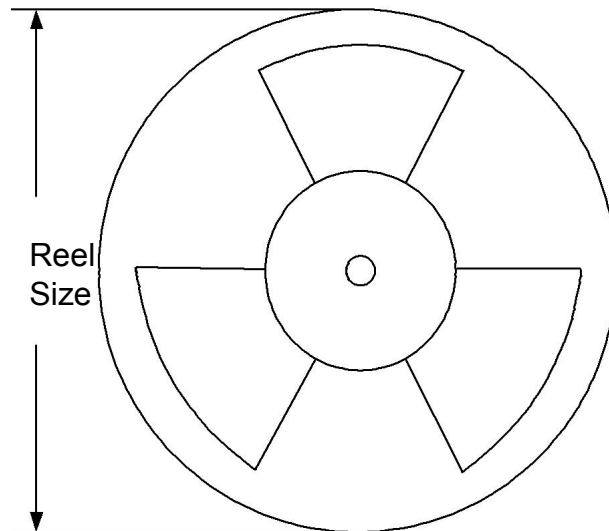

Package type	Tape width (mm)	Pocket pitch(mm)	Reel size (Inch)	Trailer length(mm)	Leader length (mm)	Qty per reel
SO8E	12	8	13"	400	400	2500

**3. Others: NA**