

SSSS9 5(H)mm, 2mm-travel Type

Mid-size general purpose type well established for user friendliness

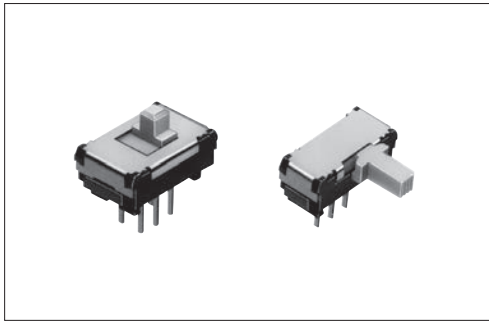

Typical Specifications



Items		Specifications	
Rating (max.)/(min.) (Resistive load)		0.1A 12V DC / 1mA 5V DC	
Contact resistance (Initial performance / After lifetime)		30mΩ max. / 80mΩ max.	
Operating force		2-position	3-position
		3±1.5N	a, c → b 2±1N b → a, c 3±1.5N
Operating life	Without load	10,000 cycles	
	With load	10,000 cycles (0.1A 12V DC)	

Product Line

Travel (mm)	Actuator direction	Actuator length (mm)	Poles	Positions	Mounting method	Changeover timing	Soldering	Minimum order unit (pcs.)		Products No.	Drawing No.					
								Japan	Export							
2	Vertical	2	1	2	Standard	Non shorting	Manual, Dip	1,000	5,000	SSSS912000	1					
					Snap-in (t1.6)					SSSS910400	2					
				3	Standard	Not specified				SSSS919500	3					
			Snap-in (t1.6)		SSSS918500					4						
			2	2	Standard	Non shorting				800	4,000	SSSS922000	5			
					Standard	Not specified						SSSS921800	6			
		4	1	2	Standard	Non shorting		1,000	5,000			SSSS912500	1			
					Snap-in (t1.6)							SSSS910800	2			
				3	Standard							Not specified	SSSS919800	3		
			Snap-in (t1.6)		SSSS918700	4										
			2	2	2	Standard						Non shorting	800	4,000	SSSS922500	5
						Snap-in (t1.6)						Not specified			SSSS923200	6
	Horizontal	2	1	2	Standard	Non shorting	1,000	5,000	SSSS916900			8				
					Snap-in (t1.6)				SSSS915001			9				
				3	Standard	Not specified			SSSS91B900			10				
			Standard		Non shorting				SSSS926400			12				
			2	2	2	Standard			Not specified	800	4,000	SSSS928500			14	
						Snap-in (t1.6)						Non shorting			SSSS916400	8
		4	1	2	Standard	Not specified	1,000	5,000	SSSS914503			9				
					Snap-in (t1.6)				SSSS91B600			10				
				3	Standard				Not specified			SSSS91A601			11	
			Snap-in (t1.6)		SSSS925800	12										
			2	2	2	Standard			Non shorting			800	4,000	SSSS923802	13	
						Snap-in (t1.6)								SSSS928200	14	
3	2	3	Standard	Not specified	800	4,000	SSSS925701	15								
			Snap-in (t1.6)													

Detector

Slide

Push

Rotary

Power

Dual-In-line
Package Type

Small size
General Use Type

Big size
General Use Type

SSSS9 5(H)mm, 2mm-travel Type

Packing Specifications

Bulk

Products No.	Number of packages (pcs.)		Export package measurements (mm)
	1 case / Japan	1 case / export packing	
SSSS921800, SSSS923200, SSSS920600, SSSS928500, SSSS928200, SSSS925701	800	4,000	400×270×290
SSSS912000, SSSS910800, SSSS926400, SSSS910400, SSSS919800, SSSS916400, SSSS919500, SSSS918700, SSSS914503, SSSS918500, SSSS922500, SSSS91B600, SSSS922000, SSSS916900, SSSS91A601, SSSS912500, SSSS915001, SSSS925800, SSSS91B900, SSSS923802	1,000	5,000	

Dimensions

Vertical Actuator Type

Unit:mm

No.	Style	PC board mounting hole dimensions (Viewed from direction A)
1	<p>1-pole, 2-position Standard type</p>	
2	<p>1-pole, 2-position Snap-in type</p>	
3	<p>1-pole, 3-position Standard type</p>	

■ Dimensions

Vertical Actuator Type

Unit:mm

No.	Style	PC board mounting hole dimensions (Viewed from direction A)
4	<p>1-pole, 3-position Snap-in type</p>	
5	<p>2-pole, 2-position Standard type</p>	
6	<p>2-pole, 3-position Standard type</p>	
7	<p>2-pole, 3-position Snap-in type</p>	

Detector

Slide

Push

Rotary

Power

Dual-in-line
Package Type

Small size
General Use Type

Big size
General Use Type

SSSS9 5(H)mm, 2mm-travel Type

■ Dimensions

Horizontal Actuator Type

Unit:mm

No.	Style	PC board mounting hole dimensions (Viewed from direction A)
8	1-pole, 2-position Standard type 	
9	1-pole, 2-position Snap-in type 	
10	1-pole, 3-position Standard type 	
11	1-pole, 3-position Snap-in type 	

■ Dimensions

Horizontal Actuator Type

Unit:mm

No.	Style	PC board mounting hole dimensions (Viewed from direction A)
12	<p>2-pole, 2-position Standard type</p>	
13	<p>2-pole, 2-position Snap-in type</p>	
14	<p>2-pole, 3-position Standard type</p>	
15	<p>2-pole, 3-position Snap-in type</p>	

Detector

Slide

Push

Rotary

Power

Dual-in-line
Package Type

Small size
General Use Type

Big size
General Use Type

SSSS9 5(H)mm, 2mm-travel Type

Detector

Slide

Push

Rotary

Power

Dual-in-line
Package Type

Small size
General Use Type

Big size
General Use Type

Detail of (a) Unit:mm

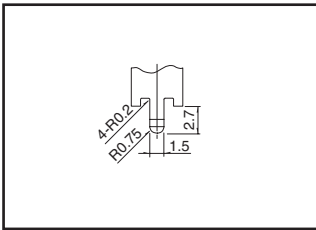



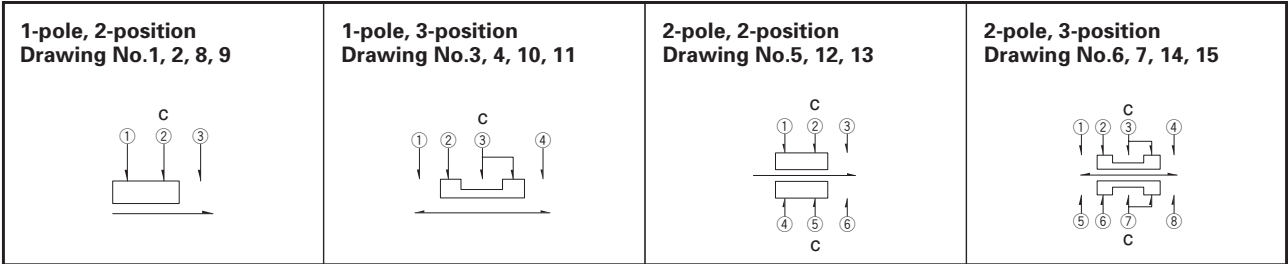





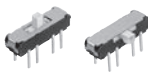

Circuit Diagram (Viewed from Direction A)



Slide Switches

List of Varieties

Series		SSSS2※	SSSS9	SSAC	SSSF	SSSU
Photo						
Actuator direction	Horizontal	●	●	●	●	●
	Vertical	●	●	—	●	●
Poles-positions	1-2	●	●	—	●	●
	1-3	●	●	—	●	●
	1-4	●	—	—	—	—
	2-2	●	●	●	●	●
	2-3	●	●	●	●	●
	2-4	●	—	—	—	—
	4-2	—	—	—	●	●
Travel (mm)		2	2	1.5	2	3
Operating temperature range		-40°C to +85°C		-10°C to +60°C	-40°C to +85°C	
Automotive use		—	—	—	—	—
Life cycle						
Rating (max.) (Resistive load)		0.3A 6V DC	0.1A 12V DC	1mA 5V DC	0.1A 30V DC	
Rating (min.) (Resistive load)		50μA 3V DC	1mA 5V DC	50μA 3V DC	10μA 1V DC	
Durability	Operating life without load	10,000 cycles 100mΩ max.※	10,000 cycles 60mΩ max.	10,000 cycles 200mΩ max.	10,000 cycles 45mΩ max.	
	Operating life with load Load: as rating	10,000 cycles 130mΩ max.※	10,000 cycles 80mΩ max.		10,000 cycles 65mΩ max.	
Electrical performance	Initial contact resistance	70mΩ max.	30mΩ max.	100mΩ max.	25mΩ max.	
	Insulation resistance	100MΩ min. 500V DC		100MΩ min. 100V DC	100MΩ min. 500V DC	
	Voltage proof	500V AC for 1minute		100V AC for 1minute	500V AC for 1minute	
Mechanical performance	Terminal strength		3N for 1minute		5N for 1minute	
	Actuator strength	Operating direction	20N	30N	5N	30N
		Pulling direction	10N			
Environmental performance	Cold	-20°C 500h	-40°C 500h	-20°C 96h	-40°C 500h	
	Dry heat	85°C 500h		85°C 96h	85°C 500h	
	Damp heat	60°C, 90 to 95%RH 500h		40°C, 90 to 95%RH 96h	60°C, 90 to 95%RH 500h	
Page		92	97	103	105	109

Slide Switches Soldering Conditions	113
Slide Switches Cautions	114

Notes

- ※ Operating life for SSSS213202 is 100 cycles.
- Indicates applicability to all products in the series.

Slide Switches Soldering Conditions

Example of Reflow Soldering Condition

1. Heating method: Double heating method with infrared heater.
2. Temperature measurement: Thermocouple ϕ 0.1 to 0.2 CA (K) or CC (T) at soldering portion (copper foil surface).
A heat resisting tape should be used for fixed measurement.
3. Temperature profile

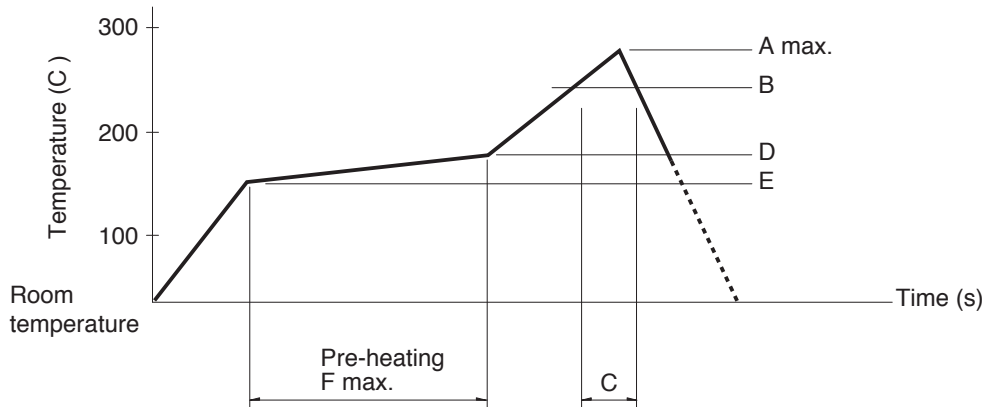

Series (Reflow type)		A (°C) 3s max.	B (°C)	C (s)	D (°C)	E (°C)	F (s)
SSSS2	Vertical 1-pole, 3-position	260	230	40	180	150	120
	Horizontal 1-pole, 2-position 1-pole, 3-position 2-pole, 3-position						
	Vertical 1-pole, 2-position	250					
SSSS7		260					
SSAH, SSAG, SSAJ, SSAL, SSSS8		260					

Notes

1. The condition mentioned above is the temperature on the mounting surface of a PC board. There are cases where the PC board's temperature greatly differs from that of the switch, depending on the PC board's material, size, thickness, etc. The above-stated conditions shall also apply to switch surface temperatures.
2. Soldering conditions differ depending on reflow soldering machines. Prior verification of soldering condition is highly recommended.

Reference for Hand Soldering

Series	Soldering temperature	Soldering time
SSSF, SSSU	350±10°C	3+1/0s
SSSS2	350±10°C	4s max.
SSSS9	350±10°C	3s max.
SSAH, SSAG, SSAJ, SSAL	350±5°C	3s max.
SSSS8	330±5°C	3s max.
SSSS7	320±5°C	3s max.
SSAC	300±10°C	2s max.

Reference for Dip Soldering

(For PC board terminal types)

Series	Items		Dip soldering	
	Preheating temperature	Preheating time	Soldering temperature	Duration of immersion
SSSS2	100°C max.	60s max.	260±5°C	3±1s
SSSS9	120°C max.	60s max.	260±5°C	5+0/-1s (2 times)
SSSF, SSSU	100°C max.	60s max.	260±5°C	10±1s/5±1s
SSAC	100°C max.	60s max.	260±5°C	5±1s