

SMD SHIELDED INDUCTOR

ASPI-0403S



RoHS
Compliant



6.6 x 4.45 x 2.92 mm

FEATURES:

- Low DCR
- High reliability
- Magnetically shielded
- High energy storage capacity
- High heat resistance, ideal for reflow soldering

APPLICATIONS:

- PDAs and Pagers
- Mobile phone
- Notebook
- Battery Charger
- Flash memory programmer
- Entertainment electronic devices

STANDARD SPECIFICATIONS:

PARAMETERS

ABRACON P/N:	ASPI-0403S-xxx Series
Operating temperature:	-40°C to + 85°C
Storage temperature:	-40°C to + 85°C

Part#	Inductance (μH)	Tol. (%)	RDC (Ω)	IDC (A)
ASPI-0403S-1R0M	1.0	M	0.040	3.00
ASPI-0403S-1R5M	1.5	M	0.045	2.80
ASPI-0403S-1R8M	1.8	M	0.048	2.30
ASPI-0403S-2R2M	2.2	M	0.050	1.80
ASPI-0403S-3R3M	3.3	M	0.055	1.60
ASPI-0403S-4R7M	4.7	M	0.060	1.40
ASPI-0403S-5R6M	5.6	M	0.062	1.30
ASPI-0403S-6R8M	6.8	M	0.065	1.20
ASPI-0403S-100M	10	M	0.075	1.00
ASPI-0403S-150M	15	M	0.090	0.80
ASPI-0403S-220M	22	M	0.110	0.70
ASPI-0403S-330M	33	M	0.190	0.60
ASPI-0403S-470M	47	M	0.230	0.50
ASPI-0403S-680M	68	M	0.290	0.40
ASPI-0403S-101M	100	M	0.480	0.30
ASPI-0403S-151M	150	M	0.590	0.26
ASPI-0403S-221M	220	M	0.770	0.22
ASPI-0403S-331M	330	M	1.400	0.20
ASPI-0403S-471M	470	M	1.800	0.19
ASPI-0403S-681M	680	M	2.200	0.18
ASPI-0403S-102M	1000	M	3.400	0.15
ASPI-0403S-152M	1500	M	4.200	0.12
ASPI-0403S-222M	2200	M	8.500	0.10
ASPI-0403S-332M	3300	M	11.000	0.08
ASPI-0403S-472M	4700	M	13.900	0.06
ASPI-0403S-682M	6800	M	25.000	0.04
ASPI-0403S-822M	8200	M	29.810	0.03
ASPI-0403S-103M	10000	M	32.800	0.02

Test Frequency is 100KHz. DCR & IDC listed are all Max. value. Tolerance: M=±20%, M tolerance is standard

PART IDENTIFICATIONS:

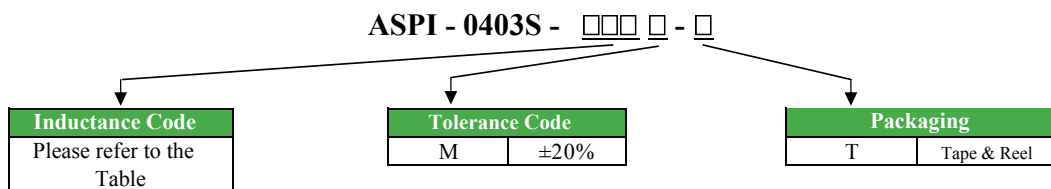

ABRACON IS
ISO 9001:2008
CERTIFIED



ABRACON
CORPORATION

Visit www.abracon.com for Terms & Conditions of Sale

30332 Esperanza, Rancho Santa Margarita, California 92688
tel 949-546-8000 | fax 949-546-8001 | www.abracon.com

Revised: 07.08.14

SMD SHIELDED INDUCTOR

ASPI-0403S



6.6 x 4.45 x 2.92 mm

INDUCTANCE VS CURRENT

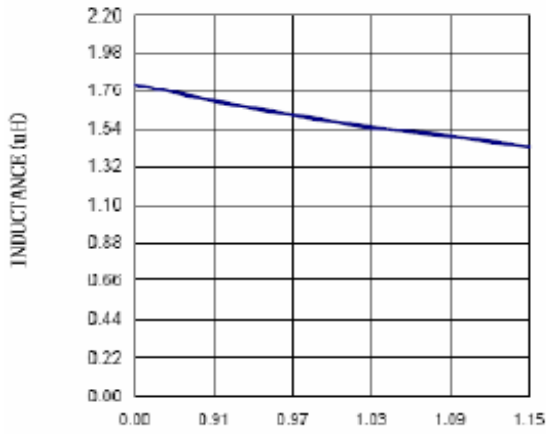

1R8M
CURRENT (A)

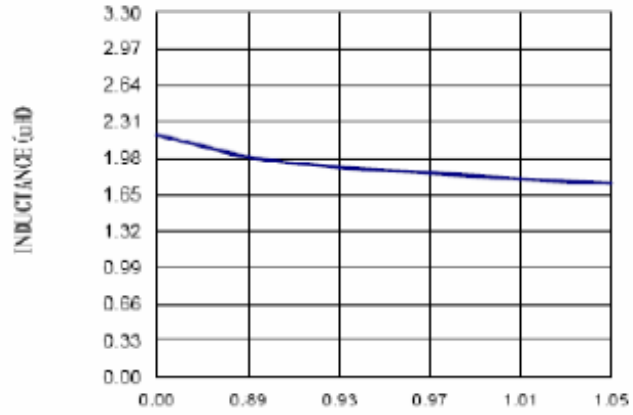

2R2M
CURRENT (A)

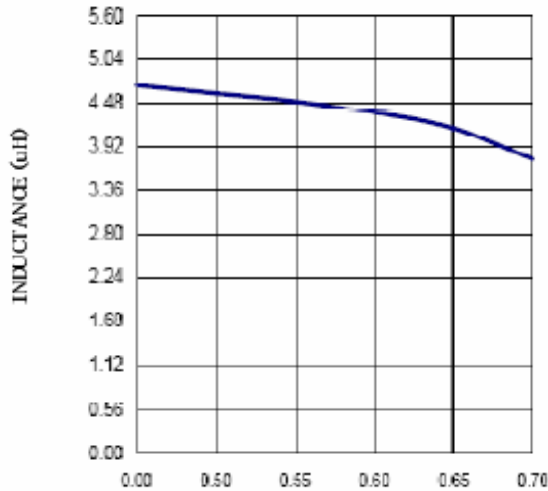

4R7M
CURRENT (A)

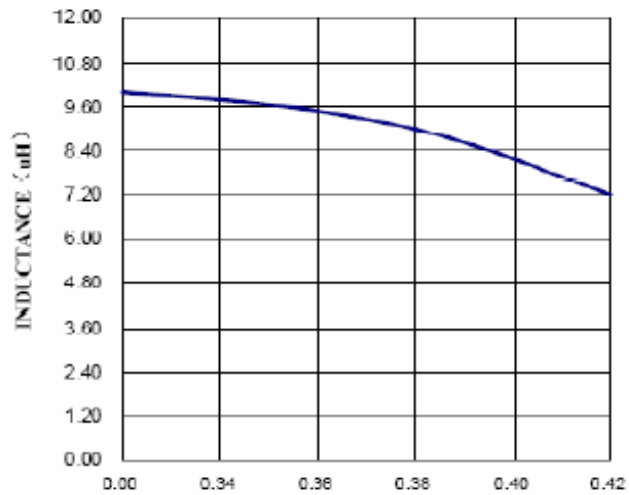

100M
CURRENT (A)

SMD SHIELDED INDUCTOR

ASPI-0403S



6.6 x 4.45 x 2.92 mm

INDUCTANCE VS CURRENT

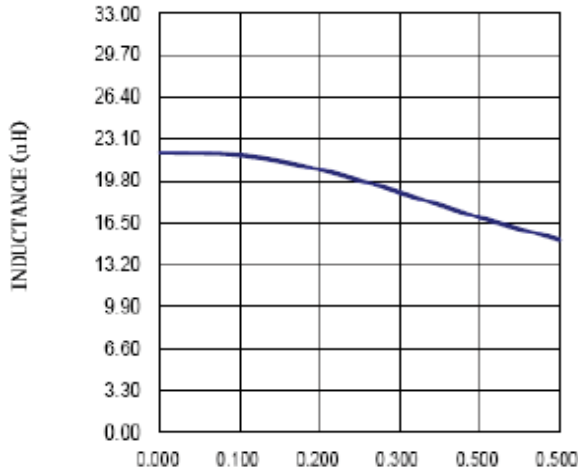

220M
CURRENT (A)

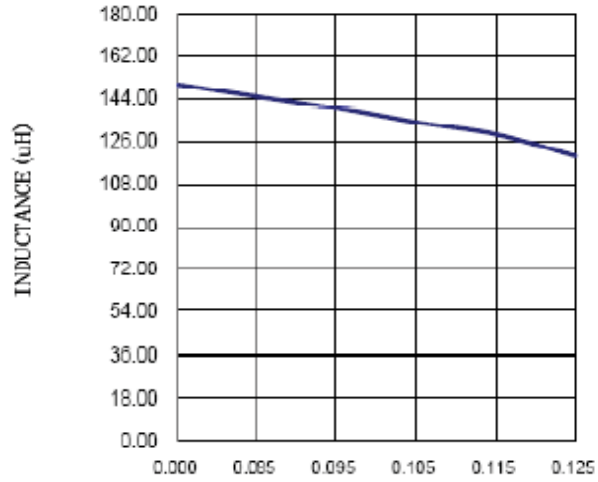

151M
CURRENT (A)

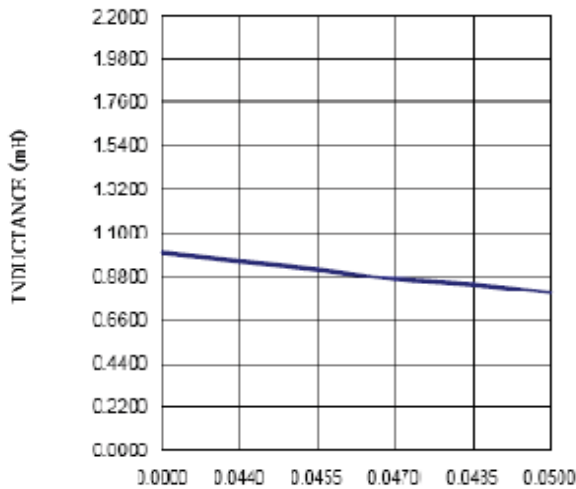

102M
CURRENT (A)

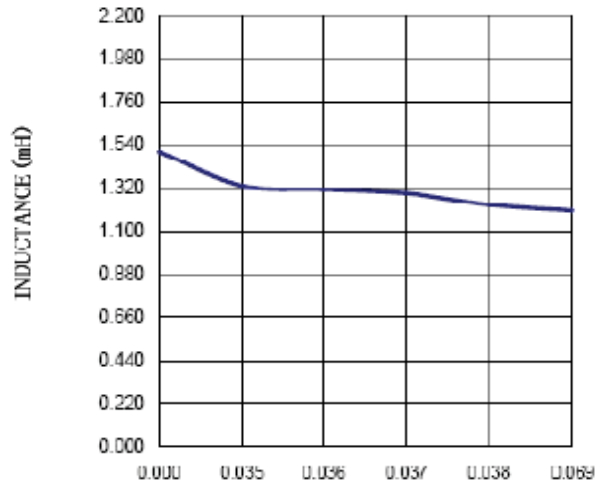

152M
CURRENT (A)

SMD SHIELDED INDUCTOR

ASPI-0403S



6.6 x 4.45 x 2.92 mm

OUTLINE DIMENSION:

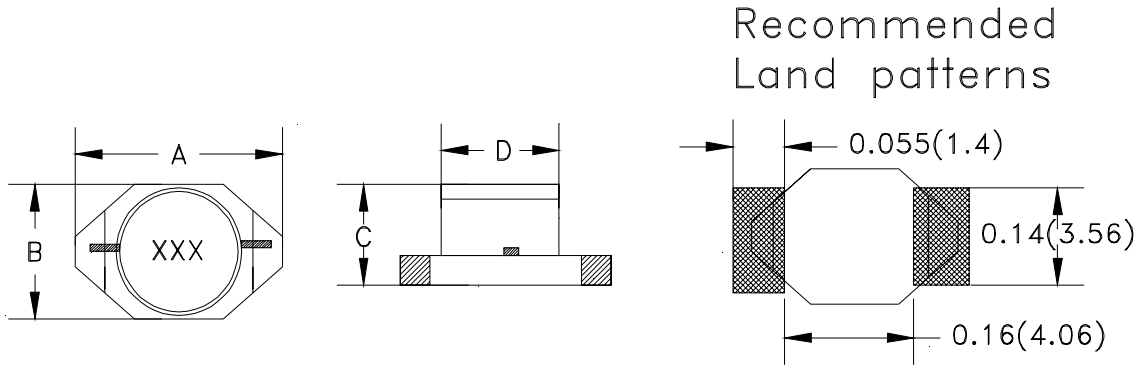

Part	A	B	C	D
ASPI-0403S-xxx	0.260 Max (6.60) Max	0.175 Max (4.45) Max	0.115 Max (2.92) Max	0.157±0.012 (4.0±0.3)

Dimensions: Inches (mm)

REFLOW PROFILE:

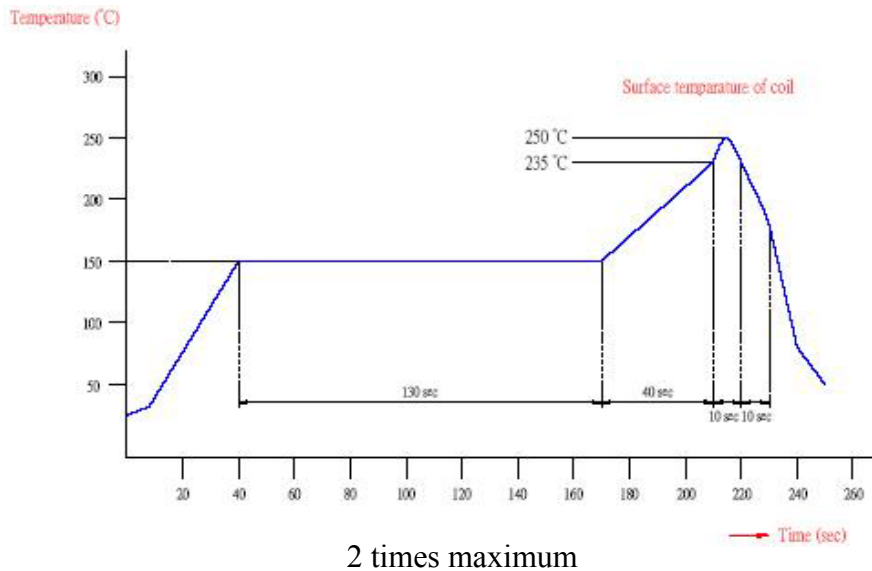

SMD SHIELDED INDUCTOR

ASPI-0403S



RoHS
Compliant



6.6 x 4.45 x 2.92 mm

TAPE & REEL:

T= tape and reel (2,500 pcs per reel)

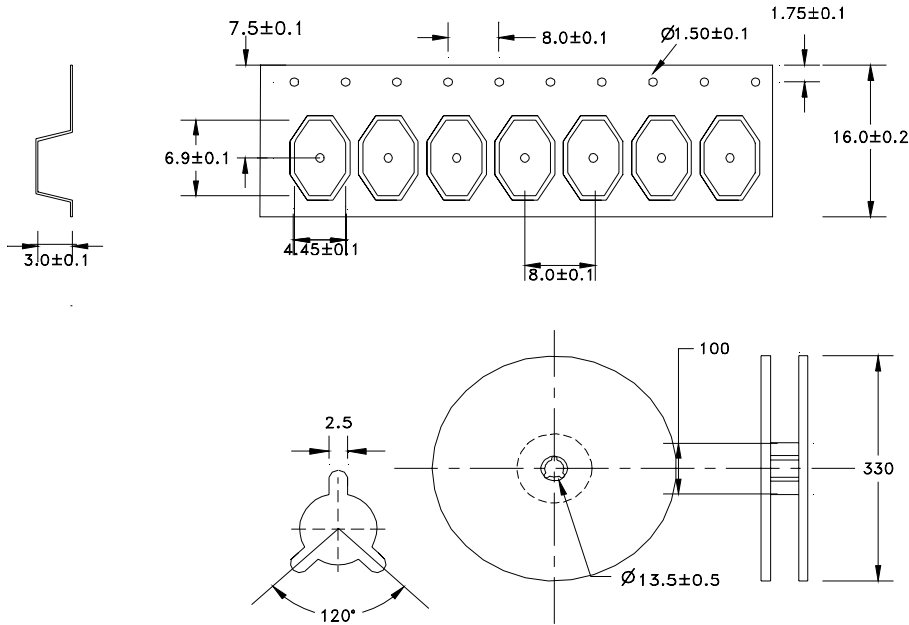

ATTENTION: Abracon Corporation's products are COTS – Commercial-Off-The-Shelf products; suitable for Commercial, Industrial and, where designated, Automotive Applications. Abracon's products are not specifically designed for Military, Aviation, Aerospace, Life-dependant Medical applications or any application requiring high reliability where component failure could result in loss of life and/or property. For applications requiring high reliability and/or presenting an extreme operating environment, written consent and authorization from Abracon Corporation is required. Please contact Abracon Corporation for more information.

ABRACON IS
ISO 9001:2008
CERTIFIED



Visit www.abracon.com for Terms & Conditions of Sale
30332 Esperanza, Rancho Santa Margarita, California 92688
tel 949-546-8000 | fax 949-546-8001 | www.abracon.com

Revised: 07.08.14