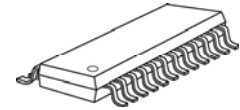

## 16-Channel PWM Constant Current LED Driver for 1:8 Time-Multiplexing Applications

### Features

- 3.0V-5.5V supply voltage
- 16 constant current output channels
- Constant output current range:
  - 2~45mA @ 5V supply voltage
  - 2~30mA @ 3.3V supply voltage
- Excellent output current accuracy:
  - Between channels:  $<\pm 2.5\%$ (Max.)
  - Between ICs:  $<\pm 3\%$ (Max.)
- Built-in 4K-bit SRAM to support time-multiplexing for 1 ~ 8 scans
- 16-bit /14-bit color depth PWM control to improve visual refresh rate
- 6bit current gain, 12.5%~200%
- LED failure isolation
  - LED failure induced cross elimination
- LED open detection
- Integrating ghost elimination circuit
- GCLK multiplier technology
- Maximum DCLK frequency: 30MHz

**Shrink SOP**

GP: SSOP24L-150-0.64

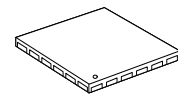
**QFN**

GFN: QFN24L-4x4-0.5

### Product Description

MBI5051 is designed for LED video applications using internal Pulse Width Modulation (PWM) control with selectable 16-bit /14-bit color depth. MBI5051 features a 16-bit shift register which converts serial input data into each pixel's gray scale of the output port. Sixteen regulated current ports are designed to provide uniform and constant current sinks for driving LEDs with a wide range of  $V_F$  variations. The output current can be preset through an external resistor. The innovative architecture with embedded SRAM is designed to support up to 1:8 time-multiplexing applications. Users only need to send the whole frame data once and to store in the embedded SRAM of the LED driver, instead of sending every time when the scan line is changed. It helps to save the data bandwidth and to achieve high grayscale with very low data clock rate. With scan-type Scrambled-PWM (S-PWM) technology, MBI5051 enhances PWM by scrambling the "on" time of each scan line into several "on" periods and sequentially drives each scan line for a short "on" period. The enhancement equivalently increases the visual refresh rate of scan-type LED displays. In addition, the innovative GCLK multiplier technique doubles visual refresh rate.

MBI5051 drives the corresponding LEDs to the brightness specified by image data. With MBI5051, all output channels can be built with 16-bit color depth (65,536 gray scales). When building a 16-bit color depth video, S-PWM technology reduces the flickers and improves the image fidelity.

Through compulsory error detection, MBI5051 detects individual LED for open-circuit errors without extra components. MBI5051 equipped an innovative cross elimination function, and it solves the cross phenomenon induced by failure LEDs. Besides, integrated ghost elimination circuit eases the ghost problems.

Block Diagram

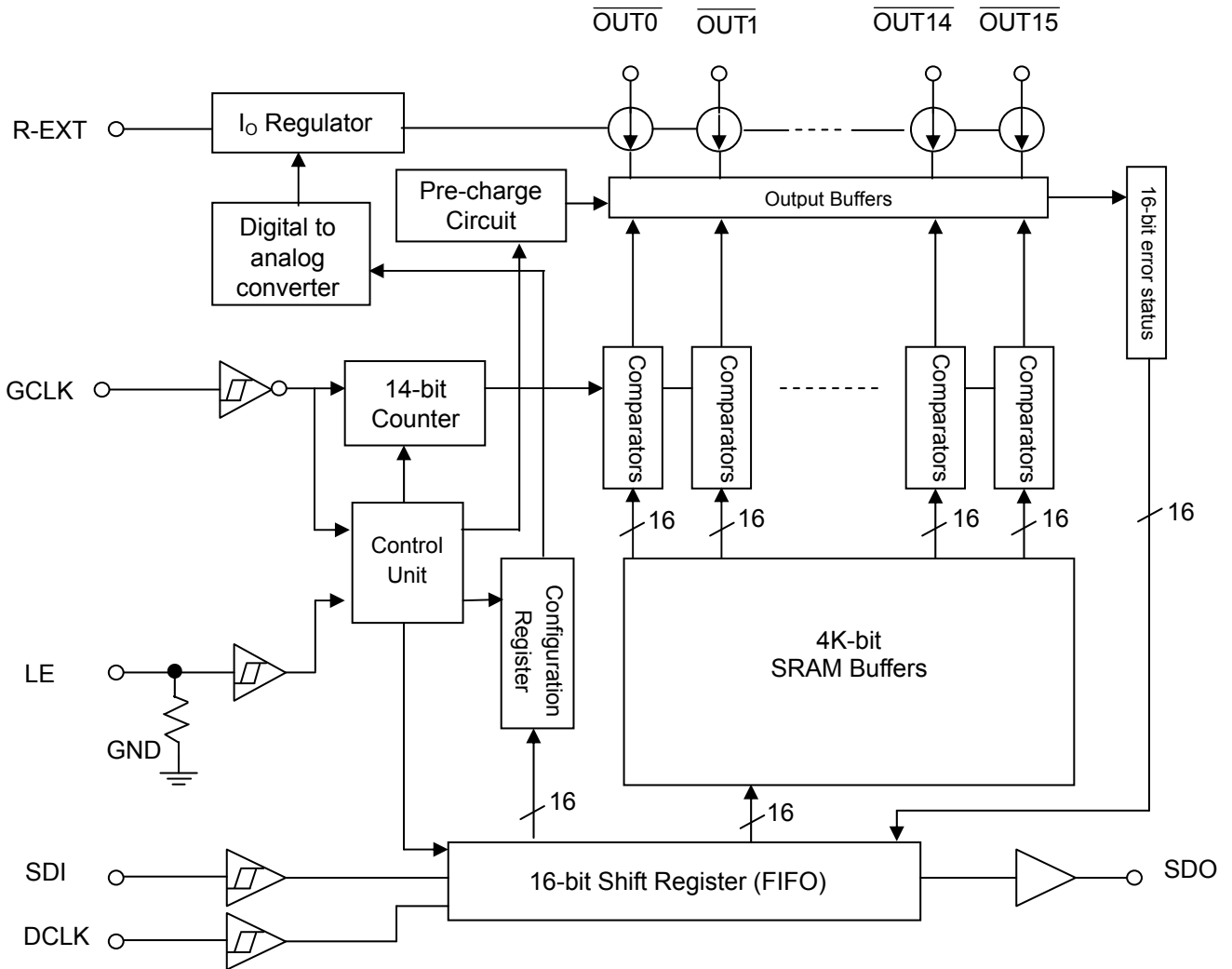
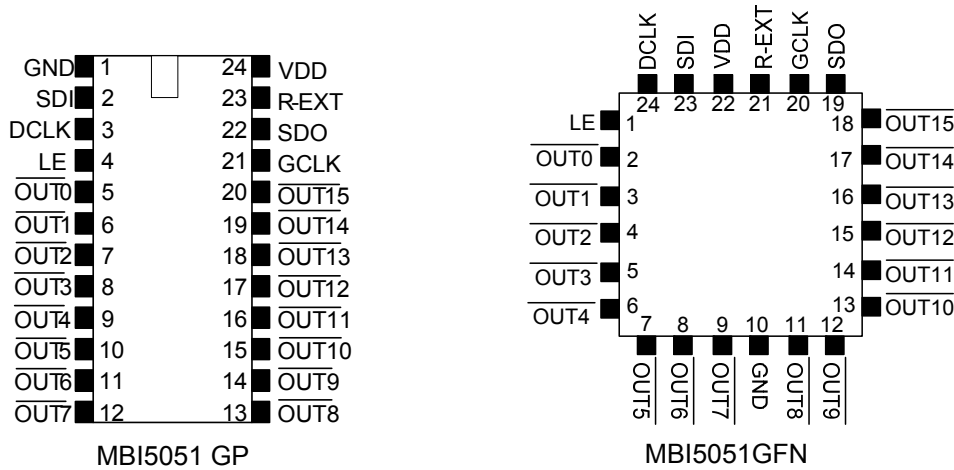

Figure 1

Pin Configuration



Terminal Description

Pin Name	Function
GND	Ground terminal for control logic and current sink
SDI	Serial-data input to the shift register
DCLK	Clock input terminal used to shift data on rising edge and carries command information when LE is asserted.
LE	Data strobe terminal and controlling command with DCLK
OUT0 ~ OUT15	Constant current output terminals
GCLK	Gray scale clock terminal Clock input for gray scale. The gray scale display is counted by gray scale clock compared with input data.
SDO	Serial-data output to the receiver-end SDI of next LED driver
R-EXT	Input terminal used to connect an external resistor for setting up output current for all output channels
VDD	3.3V/5V supply voltage terminal

Equivalent Circuits of Inputs and Outputs

**GCLK, DCLK, SDI terminal**

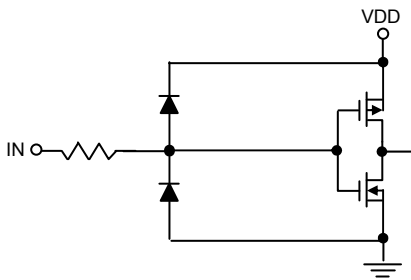

**LE Terminal**

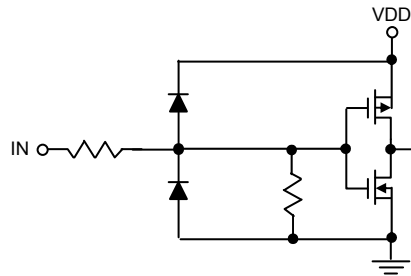

**SDO Terminal**

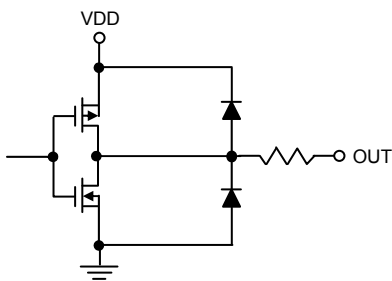

Maximum Rating

Characteristic		Symbol	Rating	Unit
Supply Voltage		$V_{DD}$	0~7	V
Input Pin Voltage (SDI, DCLK, GCLK, LE)		$V_{IN}$	-0.4~ $V_{DD}$ +0.4	V
Sustaining Voltage at OUT Port		$V_{DS}$	-0.5~17	V
Output Current		$I_{OUT}$	+45	mA
GND Terminal Current		$I_{GND}$	750	mA
Power Dissipation (On 4 Layer PCB, $T_a=25^{\circ}C$ )*	GP Type	$P_D$	1.79	W
	GFN Type		3.19	
Thermal Resistance (On 4 Layer PCB, $T_a=25^{\circ}C$ )*	GP Type	$R_{th(j-a)}$	69.5	$^{\circ}C/W$
	GFN Type		39.15	
Junction Temperature		$T_{j,max}$	150**	$^{\circ}C$
Operating Ambient Temperature		$T_{opr}$	-40~+85	$^{\circ}C$
Storage Temperature		$T_{stg}$	-55~+150	$^{\circ}C$
ESD Rating	Human Body Mode (MIL-STD-883H Method 3015.8)	HBM	Class 3A (4KV)	-
	Machine Mode (ANSI/ ESD S5.2-2009)	MM	Class M3 (350V)	-

\*The PCB size is 76.2mm\*114.3mm in simulation. Please refer to JEDEC JESD51.

\*\*Operation at the maximum rating for extended periods may reduce the device reliability; therefore, the suggested junction temperature of the device is under 125 $^{\circ}C$ .

Note: The performance of thermal dissipation is strongly related to the size of thermal pad, thickness and layer numbers of the PCB. The empirical thermal resistance may be different from simulative value. User should plan for expected thermal dissipation performance by selecting package and arranging layout of the PCB to maximize the capability.

for 1:8 Time-multiplexing Applications

Electrical Characteristics ( $V_{DD}=5.0V$ ,  $T_a=25^{\circ}C$ )

Characteristics		Symbol	Condition	Min.	Typ.	Max.	Unit	
Supply Voltage		$V_{DD}$	-	4.5	5.0	5.5	V	
Sustaining Voltage at OUT Ports		$V_{DS}$	$\overline{OUT0} \sim \overline{OUT15}$	-	-	17.0	V	
Output Current		$I_{OUT}$	Refer to "Test Circuit for Electrical Characteristics"	2	-	45	mA	
		$I_{OH}$	SDO	-	-	-1.0	mA	
		$I_{OL}$	SDO	-	-	1.0	mA	
Input Voltage	"H" level	$V_{IH}$	$T_a=-40\sim 85^{\circ}C$	$0.7 \times V_{DD}$	-	$V_{DD}$	V	
	"L" level	$V_{IL}$	$T_a=-40\sim 85^{\circ}C$	GND	-	$0.3 \times V_{DD}$	V	
Output Leakage Current		$I_{OH}$	$V_{DS}=17.0V$	-	-	0.5	$\mu A$	
Output Voltage	SDO	$V_{OH}$	$I_{OH}=-1.0mA$	$V_{DD}-0.4$	-	-	V	
		$V_{OL}$	$I_{OL}=+1.0mA$	-	-	0.4	V	
Current Skew (Channel)		$dI_{OUT1}$	$I_{OUT}=25mA$ $V_{DS}=1.0V$	$R_{ext}=560\Omega$	-	$\pm 1.5$	$\pm 2.5$	%
Current Skew (IC)		$dI_{OUT2}$	$I_{OUT}=25mA$ $V_{DS}=1.0V$	$R_{ext}=560\Omega$	-	$\pm 1.5$	$\pm 3.0$	%
Output Current vs. Output Voltage Regulation*		$\%/dV_{DS}$	$V_{DS}$ within 1.0V and 3.0V $R_{ext}=560\Omega@25mA$		-	$\pm 0.1$	$\pm 0.5$	% / V
Output Current vs. Supply Voltage Regulation*		$\%/dV_{DD}$	$V_{DD}$ within 4.5V and 5.5V $R_{ext}=560\Omega@25mA$		-	$\pm 1.0$	$\pm 2.0$	% / V
LED Open Detection Threshold		$V_{OD,TH}$	-	-	0.5	-	V	
Pull-down Resistor		$R_{IN(down)}$	LE	250	450	800	K $\Omega$	
Supply Current	"Off" (SDI=DCLK=GCLK=0Hz)	$I_{DD(off) 1}$	$R_{ext}=\text{Open}, \overline{OUT0} \sim \overline{OUT15} = \text{Off}$		-	3.4	6.0	mA
		$I_{DD(off) 2}$	$R_{ext}=560\Omega, \overline{OUT0} \sim \overline{OUT15} = \text{Off}$		-	7.7	12	
		$I_{DD(off) 3}$	$R_{ext}=360\Omega, \overline{OUT0} \sim \overline{OUT15} = \text{Off}$		-	9.7	15	
	"On" (SDI= DCLK=5MHz, GCLK=20MHz)	$I_{DD(on) 2}$	$R_{ext}=560\Omega, \overline{OUT0} \sim \overline{OUT15} = \text{On}$		-	7.8	15	
		$I_{DD(on) 3}$	$R_{ext}=360\Omega, \overline{OUT0} \sim \overline{OUT15} = \text{On}$		-	9.8	20	

\*One channel on.

Electrical Characteristics ( $V_{DD}=3.3V$ ,  $T_a=25^{\circ}C$ )

Characteristics		Symbol	Condition	Min.	Typ.	Max.	Unit
Supply Voltage		$V_{DD}$	-	3.0	3.3	3.6	V
Sustaining Voltage at OUT Ports		$V_{DS}$	$\overline{OUT0} \sim \overline{OUT15}$	-	-	17.0	V
Output Current		$I_{OUT}$	Refer to "Test Circuit for Electrical Characteristics"	2	-	30	mA
		$I_{OH}$	SDO	-	-	-1.0	mA
		$I_{OL}$	SDO	-	-	1.0	mA
Input Voltage	"H" level	$V_{IH}$	$T_a=-40\sim85^{\circ}C$	$0.7 \times V_{DD}$	-	$V_{DD}$	V
	"L" level	$V_{IL}$	$T_a=-40\sim85^{\circ}C$	GND	-	$0.3 \times V_{DD}$	V
Output Leakage Current		$I_{OH}$	$V_{DS}=17.0V$	-	-	0.5	$\mu A$
Output Voltage	SDO	$V_{OH}$	$I_{OH}=-1.0mA$	$V_{DD}-0.4$	-	-	V
		$V_{OL}$	$I_{OL}=+1.0mA$	-	-	0.4	V
Current Skew (Channel)		$dI_{OUT1}$	$I_{OUT}=25mA$ $V_{DS}=1.0V$ $R_{ext}=560\Omega$	-	$\pm 1.5$	$\pm 2.5$	%
Current Skew (IC)		$dI_{OUT2}$	$I_{OUT}=25mA$ $V_{DS}=1.0V$ $R_{ext}=560\Omega$	-	$\pm 1.5$	$\pm 3.0$	%
Output Current vs. Output Voltage Regulation*		$\%/dV_{DS}$	$V_{DS}$ within 1.0V and 3.0V $R_{ext}=560\Omega@25mA$	-	$\pm 0.1$	$\pm 0.3$	% / V
Output Current vs. Supply Voltage Regulation*		$\%/dV_{DD}$	$V_{DD}$ within 3.0V and 3.6V $R_{ext}=560\Omega@25mA$	-	$\pm 1.0$	$\pm 2.0$	% / V
LED Open Detection Threshold		$V_{OD,TH}$	-	-	0.3	-	V
Pull-down Resistor		$R_{IN(down)}$	LE	250	450	800	K $\Omega$
Supply Current	"Off" (SDI=DCLK=GCLK=0Hz)	$I_{DD(off) 1}$	$R_{ext}=\text{Open}, \overline{OUT0} \sim \overline{OUT15} = \text{Off}$	-	3.2	6	mA
		$I_{DD(off) 2}$	$R_{ext}=560\Omega, \overline{OUT0} \sim \overline{OUT15} = \text{Off}$	-	7.4	12	
	"On" (SDI= DCLK=5MHz, GCLK=20MHz)	$I_{DD(on) 2}$	$R_{ext}=560\Omega, \overline{OUT0} \sim \overline{OUT15} = \text{On}$	-	7.4	15	

\*One channel on.

**Test Circuit for Electrical Characteristics**

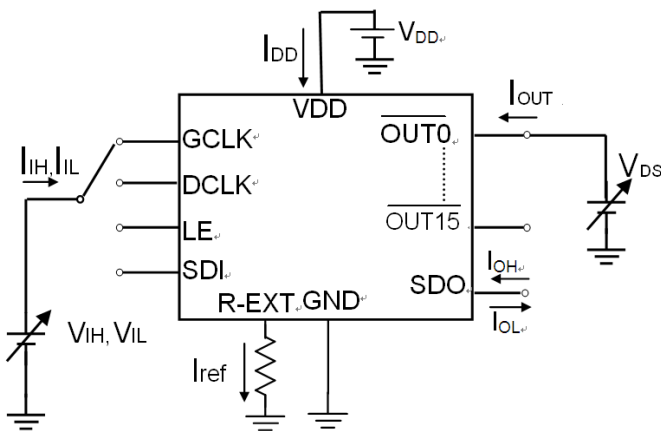

Figure 2

for 1:8 Time-multiplexing Applications

Switching Characteristics ( $V_{DD}=5.0V, T_a=25^{\circ}C$ )

Characteristics		Symbol	Condition	Min.	Typ.	Max.	Unit
Setup Time	SDI - DCLK ↑	$t_{SU0}$	$V_{DD}=5.0V$ $V_{IH}=V_{DD}$ $V_{IL}=GND$ $R_{ext}=1.4K\Omega$ $V_{DS}=1V$ $R_L=300\Omega$ $C_L=10pF$ $C_1=100nF$ $C_2=10\mu F$ $C_{SDO}=10pF$ $V_{LED}=4.0V$	5	-	-	ns
	LE ↑ - DCLK ↑	$t_{SU1}$		8	-	-	ns
	LE ↓ (Vsync) - GCLK	$t_{SU2}$		1200	-	-	ns
	LE ↓ - DCLK ↑	$t_{SU3}$		50	-	-	ns
Hold Time	DCLK ↑ - SDI	$t_{H0}$		6	-	-	ns
	DCLK ↑ - LE	$t_{H1}$		8	-	-	ns
	GCLK - LE ↑ (Vsync)	$t_{H2}$		300	-	-	ns
Propagation Delay Time	DCLK - SDO	$t_{PD0}$		-	22	25	ns
	GCLK - $\overline{OUT2n}$ **	$t_{PD1}$		-	35	-	ns
	LE - SDO	$t_{PD2}$ ***		-	30	40	ns
Staggered Delay of Output	$\overline{OUT2n+1}$ **	$t_{DL1}$		-	5	-	ns
Pulse Width	LE	$t_{w(LE)}$		15	-	-	ns
Command to Command		$T_{CC}$		50	-	-	ns
Data Clock Frequency		$F_{DCLK}$		-	-	30	MHz
Gray Scale Clock Frequency***		$F_{GCLK}$		-	-	33	MHz
GCLK frequency (when GCLK multiplier is enabled )		$F_{GCLK}$		-	-	16.6	MHz
Min Clock(GCLK/ DCLK) Pulse Width****		$t_{w(CLK)}$		12	-	-	ns
Ratio of (GCLK freq)/ (DCLK freq)		$R_{(GCLK/DCLK)}$		20	-	-	%
Compulsory Error Detection Operation time*****		$t_{ERR-C}$		700	-	-	ns
Output Rise Time of Output Ports		$t_{OR}$	-	15	25	ns	
Output Fall Time of Output Ports		$t_{OF}$	-	15	25	ns	
Dead Time		$t_{dth}$	300	-	-	ns	
Dead Time (Low state)		$t_{dtl}$	1200	-	-	ns	

\*Output waveforms have good uniformity among channels.

\*\* Refer to the Timing Waveform, where n=0, 1, 2, 3, 4, 5, 6, 7.

\*\*\*In timing of "configuration read", the next DCLK rising edge should be  $t_{PD2}$  after LE's falling edge.

\*\*\*\*The Gray Scale Clock period must be 50% duty cycle when the function of GCLK multiplier is enabled.

\*\*\*\*\*Users have to leave more time than the maximum error detection time for the error detection.



for 1:8 Time-multiplexing Applications

Switching Characteristics ( $V_{DD}=3.3V, T_a=25^{\circ}C$ )

Characteristics		Symbol	Condition	Min.	Typ.	Max.	Unit
Setup Time	SDI - DCLK ↑	$t_{SU0}$	$V_{DD}=3.3V$ $V_{IH}=V_{DD}$ $V_{IL}=GND$ $R_{ext}=1.4K\Omega$ $V_{DS}=1V$ $R_L=300\Omega$ $C_L=10pF$ $C_1=100nF$ $C_2=10\mu F$ $C_{SDO}=10pF$ $V_{LED}=4.0V$	7	-	-	ns
	LE - DCLK ↑	$t_{SU1}$		10	-	-	ns
	LE ↓ (Vsync) - GCLK	$t_{SU2}$		1200	-	-	ns
	LE ↓ - DCLK ↑	$t_{SU3}$		52	-	-	ns
Hold Time	DCLK ↑ - SDI	$t_{H0}$		8	-	-	ns
	DCLK ↑ - LE	$t_{H1}$		10	-	-	ns
	GCLK - LE ↓ (Vsync)	$t_{H2}$		300	-	-	ns
Propagation Delay Time	DCLK - SDO	$t_{PD0}$		-	30	33	ns
	GCLK - <del>OUT2n</del> *	$t_{PD1}$		-	45	-	ns
	LE - SDO	$t_{PD2}^{***}$		-	40	50	ns
Staggered Delay of Output	<del>OUT2n+1</del> **	$t_{DL1}$		-	8	-	ns
Pulse Width	LE	$t_{w(LE)}$		16	-	-	ns
Command to Command		$t_{cc}$		52	-	-	ns
Data Clock Frequency		$F_{DCLK}$		-	-	25	MHz
Gray Scale Clock Frequency****		$F_{GCLK}$		-	-	20	MHz
GCLK frequency (when GCLK multiplier is enabled)		$F_{GCLK}$		-	-	10	MHz
Min Clock(GCLK/ DCLK) Pulse Width****		$t_{w(CLK)}$		13	-	-	ns
Ratio of (GCLK freq)/ (DCLK freq)		$R_{(GCLK/DCLK)}$		20	-	-	%
Compulsory Error Detection Operation time*****		$t_{ERR-C}$		700	-	-	ns
Output Rise Time of Output Ports		$t_{OR}$	-	20	25	ns	
Output Fall Time of Output Ports		$t_{OF}$	-	20	25	ns	
Dead Time		$t_{dth}$	300	-	-	ns	
Dead Time (Low state)		$t_{dtl}$	1200	-	-	ns	

\*Output waveforms have good uniformity among channels.

\*\* Refer to the Timing Waveform, where n=0, 1, 2, 3, 4, 5, 6, 7.

\*\*\*In timing of “configuration read”, the next DCLK rising edge should be  $t_{PD2}$  after LE’s falling edge.

\*\*\*\*The Gray Scale Clock period must be 50% duty cycle when the function of GCLK multiplier is enabled.

\*\*\*\*\*Users have to leave more time than the maximum error detection time for the error detection.

**Test Circuit for Switching Characteristics**

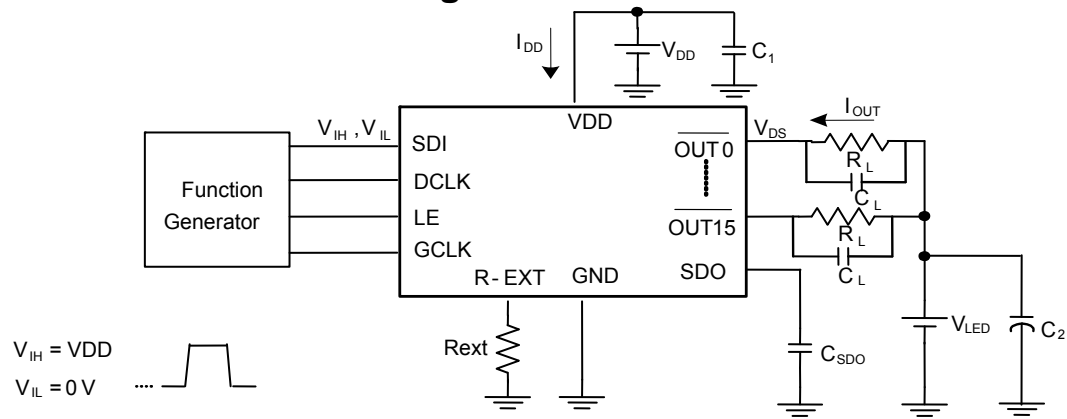
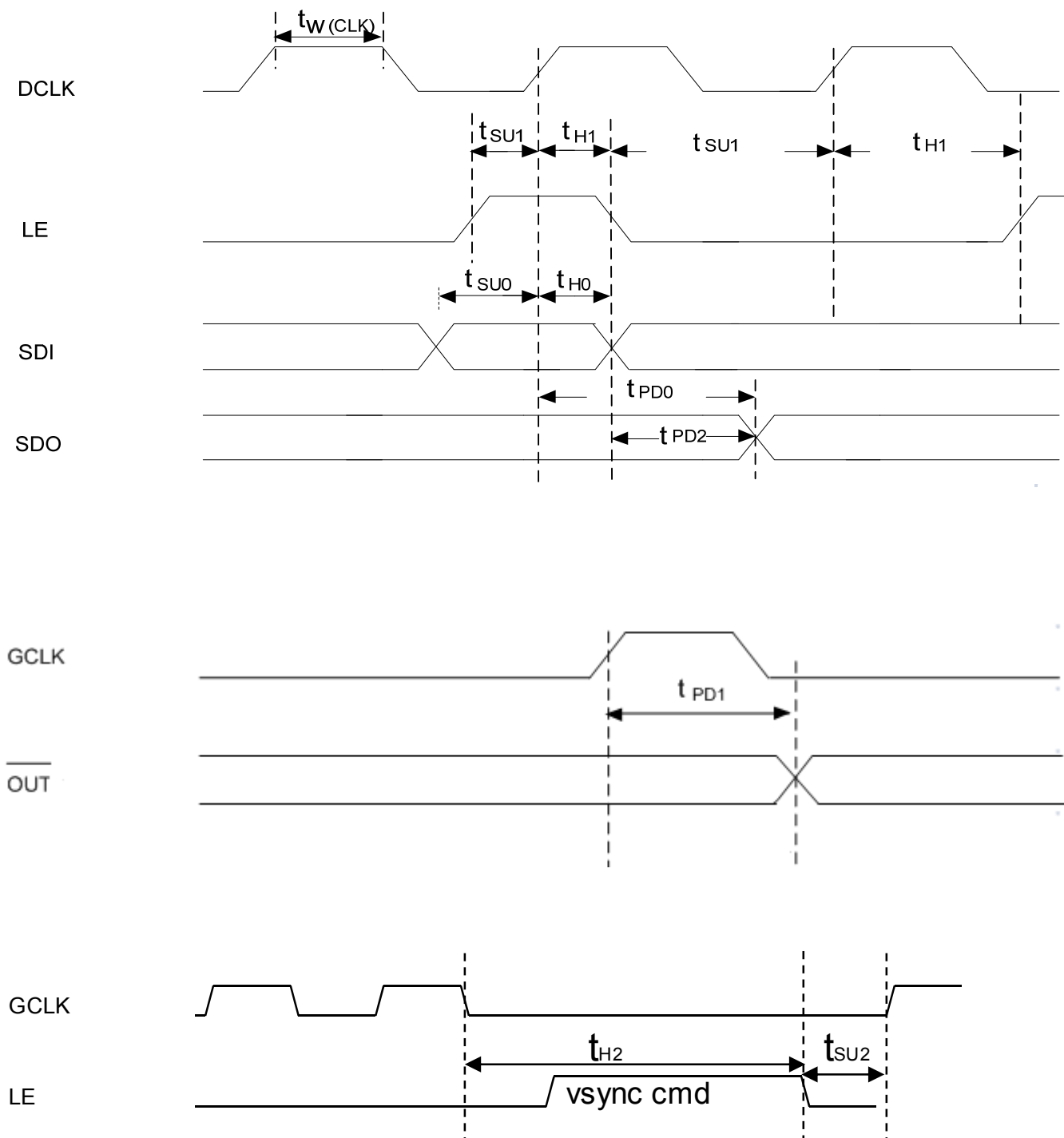
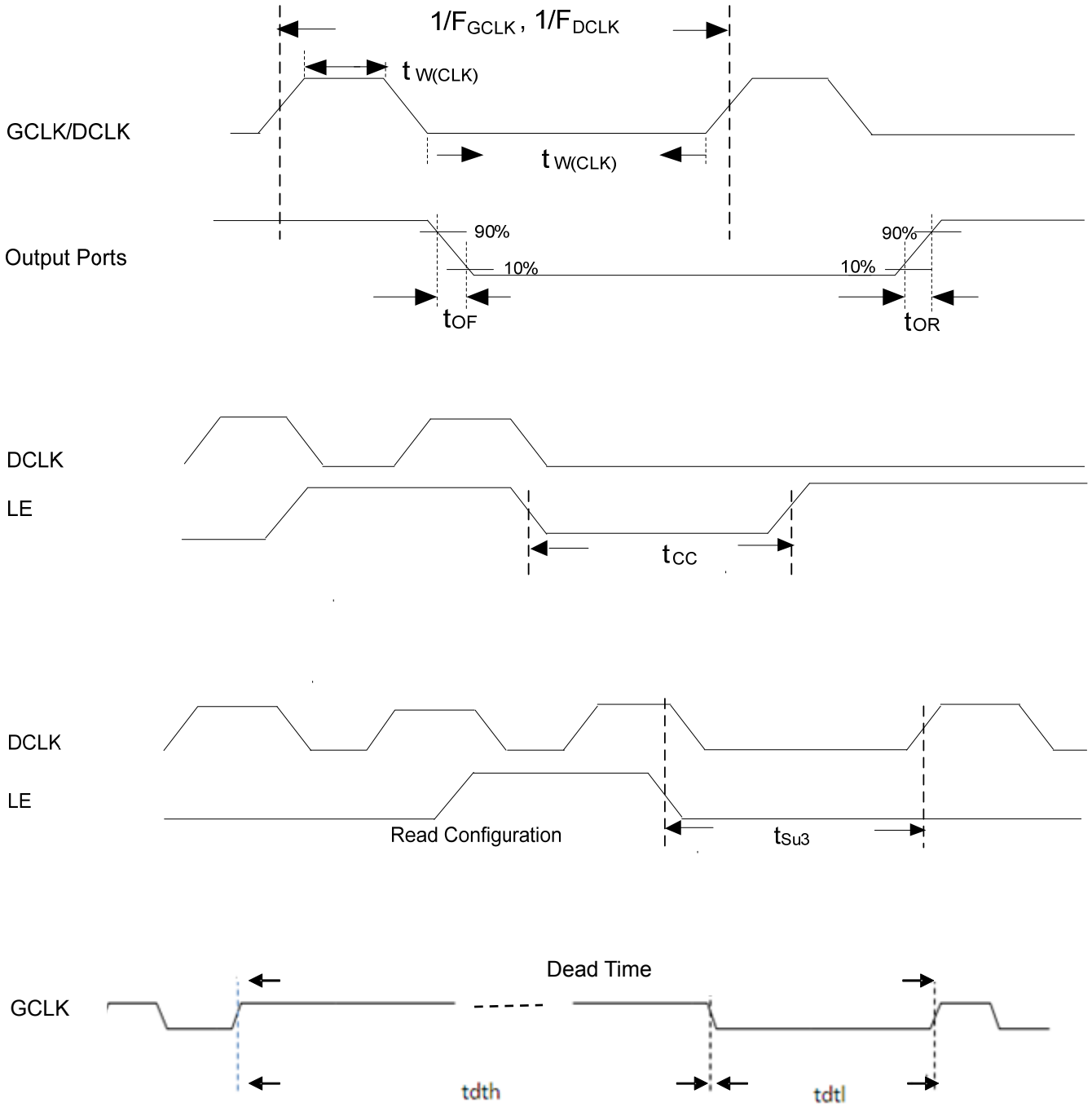

Figure 3

Timing Waveform





Control Command

Command Name	Signals Combination		Description
	LE	Number of DCLK Rising Edge when LE is asserted	Action of Command
Stop Compulsory Error detection	High	1	Stop compulsory LED open detection.
Data Latch	High	1	Serial data are transferred to the input data buffers.
VSYNC	High	2	Vertical Synchronal signal. Displaying frame will be updated to output channel.
Write Configuration 1*	High	4	Serial data are written to the configuration register.1
Read Configuration 1	High	5	Serial data are read from the configuration register.1
Start Compulsory Error detection	High	7	Start compulsory LED open detection
Write Configuration 2*	High	8	Serial data are written to the configuration register.2
Read Configuration 2	High	9	Serial data are read from the configuration register.2
Software Reset	High	10	Reset the behavior of MBI5051 except the value of configuration registers.
Pre-Active	High	14	Pre-Active command needs to be sent before "Write Configuration" command.

\*Those commands can only be activated after Pre-Active command; otherwise, they will be invalid.

**Note:** When the power is on, Vsync command will be valid only after 16 times of "Data Latch" commands that have been sent in advance.

The following figures show the waveforms of commands which require or don't require "Pre-Active" ahead.

Commands which don't require Pre-Active ahead

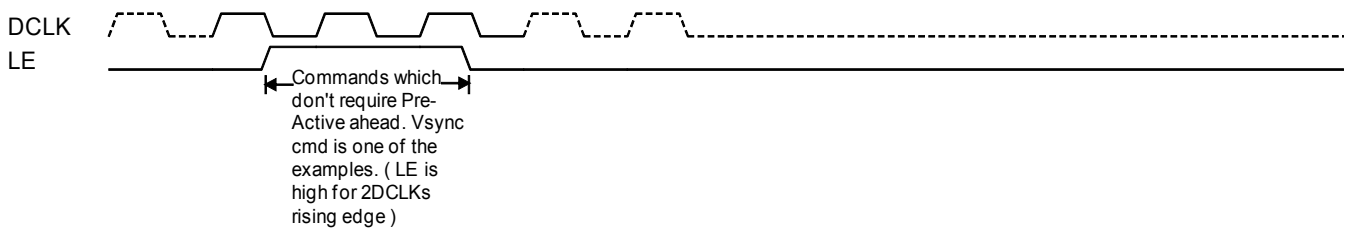

Commands which require Pre-Active ahead

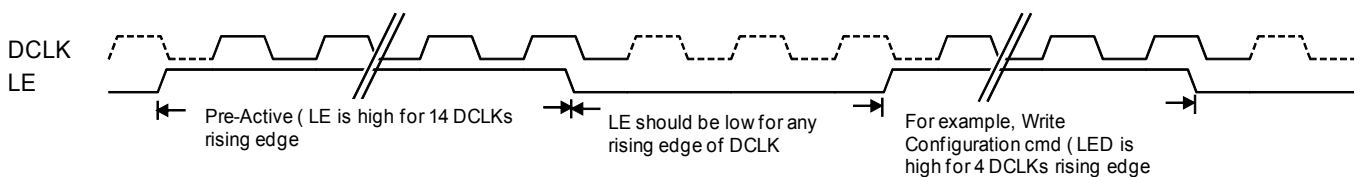

Waveform of Commands

The following figures show the waveforms of each command.

**Data Latch**

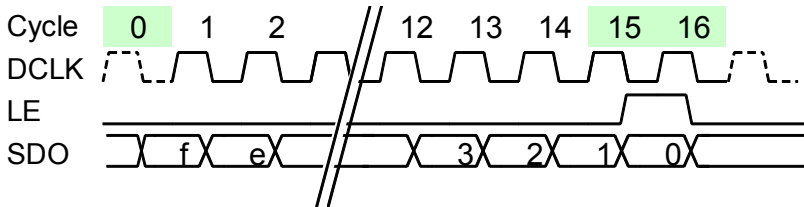

Data Latch command is used to latch the 16-bit shift register from SDI to internal SRAM buffer. When this command is received, the last 16 bits data before the falling edge of LE will be latched into SRAM, as shown in the above waveform, and MSB bit needs to be sent first.

**Vertical Sync (VSYNC)**

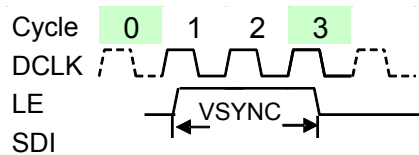

“VSYNC” command is used to update frame data on output channels ( $\overline{OUTC}$ ~ $\overline{OUT15}$ ). There are some timing limitations between signal “LE” and “GCLK”; and please refer to the section of “Vsync Command Operation” for details.

**Write Configuration**

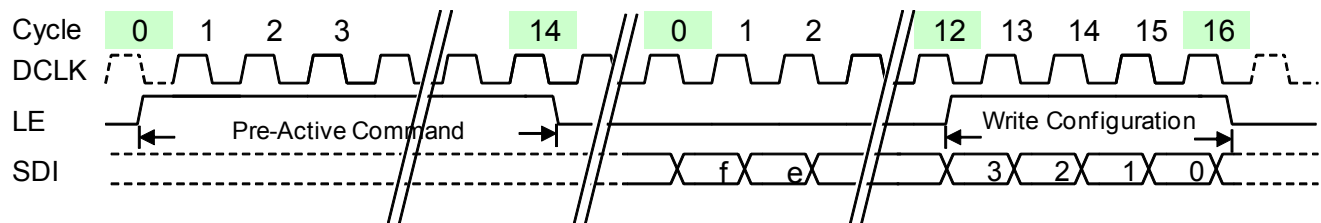

“Write configuration” command is used to program the configuration register of MBI5051. The “Pre-Active” command must be sent in advance. When this command is received, the last 16 bits data before the falling edge of LE will be latched into configuration register, as shown in the above waveform, and MSB bit needs to be sent first.

**Read Configuration**

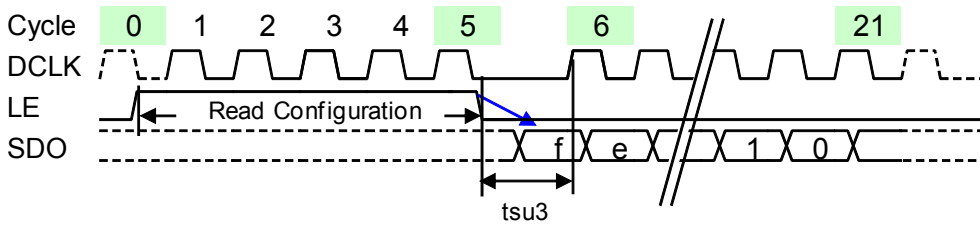

“Read configuration” command is used to read the configuration register of MBI5051. When this command is received, the 16-bit data of configuration register will be shifted out from SDO pin, as shown in the above waveform, and MSB bit will be shifted out first.

**Software Reset**

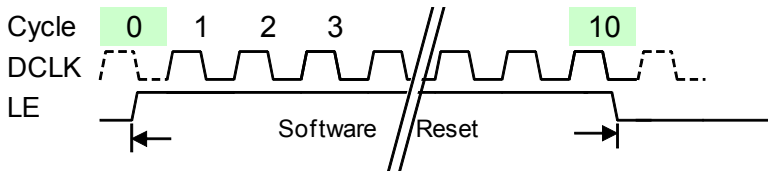

“Software reset” command makes MBI5051 go back to the initial state except configuration register value. After this command is received, the output channels will be turned off and will display again with last gray-scale value after new “Vsync” command is received.

**Definition of Configuration Register 1**

MSB														LSB	
F	E	D	C	B	A	9	8	7	6	5	4	3	2	1	0

e.g. Default Value

F	E	D	C	B	A	9	8	7	6	5	4	3	2	1	0
0	0	0	0	0	0	1	1	0	0	101011					

Default setting of configuration register is 16'h032B

Bit	Attribute	Definition	Value	Function
F	Read/ Write	Lower ghost elimination	0 (Default)	0: Disable 1: Enabled
E~B	Reserved	Reserved	0000 (Default)	Reserved
A-8	Read/ Write	Number of scan lines	000 001 010 011 (Default) ~ 111	000: 1 lines 001: 2 lines 010: 3 lines 011: 4 lines (default) 100: 5 lines 101: 6 lines 110: 7 lines 111: 8 lines
7	Read/ Write	Gray scale mode	0 (Default)	The 65536 GCLKs (16-bit) PWM cycle is divided into 64 sections, each section has 1024 GCLKs.
			1	The 16384 GCLKs (14-bit) PWM cycle is divided into 32 sections, each section has 512 GCLKs. User still send 16bit data with 2 bit 0 in LSB bits. Ex.{14'h1234, 2'h0}.
6	Read/ Write	GCLK multiplier	0 (Default)	GCLK multiplier disable
			1	GCLK multiplier enable
5~0	Read/ Write	Current gain adjustment	000000~111111	6'b101011 (Default) Allow 64-step programmable current gain from 12.5 % to 200%.



**Definition of Configuration Register 2**

MSB														LSB	
F	E	D	C	B	A	9	8	7	6	5	4	3	2	1	0

e.g. Default Value

F	E	D	C	B	A	9	8	7	6	5	4	3	2	1	0
0	0	0	1	0	0	0	0	0	0	0	1	0	0	0	0

Default setting of configuration register is 16'h1010

Bit	Attribute	Definition	Value	Function
F~B	Reserved	Reserved	Reserved	Reserved
A	Read/Write	Double refresh rate	0(Default)	0: Disable 1: Enable
9~4	Reserved	Reserved	Reserved	Reserved
3~1	Read/Write	dim line compensation	000 (Default)	000: 0 ns, 100: 20ns 001: 5 ns, 101: 25ns 010: 10 ns, 110: 30ns 011: 15 ns, 111: 35ns
0	Reserved	Reserved	Reserved	Reserved

**Number of Scan Line**

MBI5051 supports 1 to 8 scan lines. Please set the configuration register1 bit [A:8] according to the application. The default value '011' is 4 scan lines.

**Gray Scale Mode and Scan-type S-PWM**

MBI5051 provides a selectable 16-bit or 14-bit gray scale by setting the configuration register1 bit [7]. The default value is set to '0' for 16-bit color depth. In 14-bit gray scale mode, users should still send 16-bit data with 2-bit '0' in LSB bits. For example, {14'h1234, 2'h0}.

MBI5051 has a smart S-PWM technology for scan type. With S-PWM, the total PWM cycles can be broken into MSB (Most Significant Bits) and LSB (Least Significant Bits) of gray scale cycles. The MSB information can be broken down into many refresh cycles to achieve overall same high bit resolution.

**GCLK Multiplier**

MBI5051 provides a GCLK multiplier function by setting the configuration register1 bit [6]. The default value is set to '0' for GCLK multiplier disable.

GCLK multiplier disabled (configuration register1 bit [6] = 0)

Display sequence of 64 scrambles

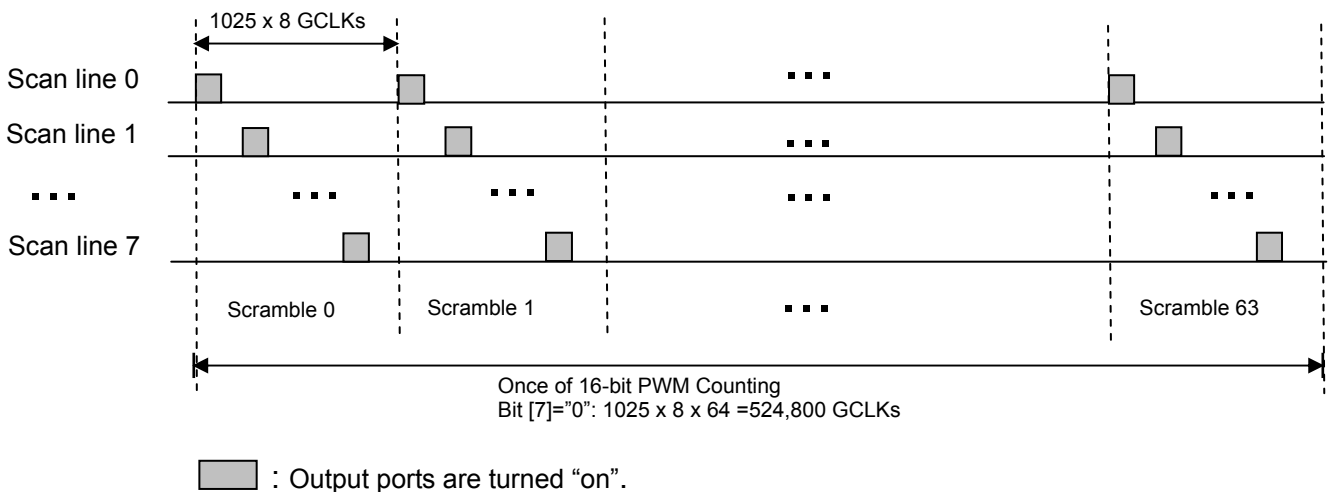

GCLK multiplier enabled (configuration register1 bit [6] = 1)

Display sequence of 64 scrambles

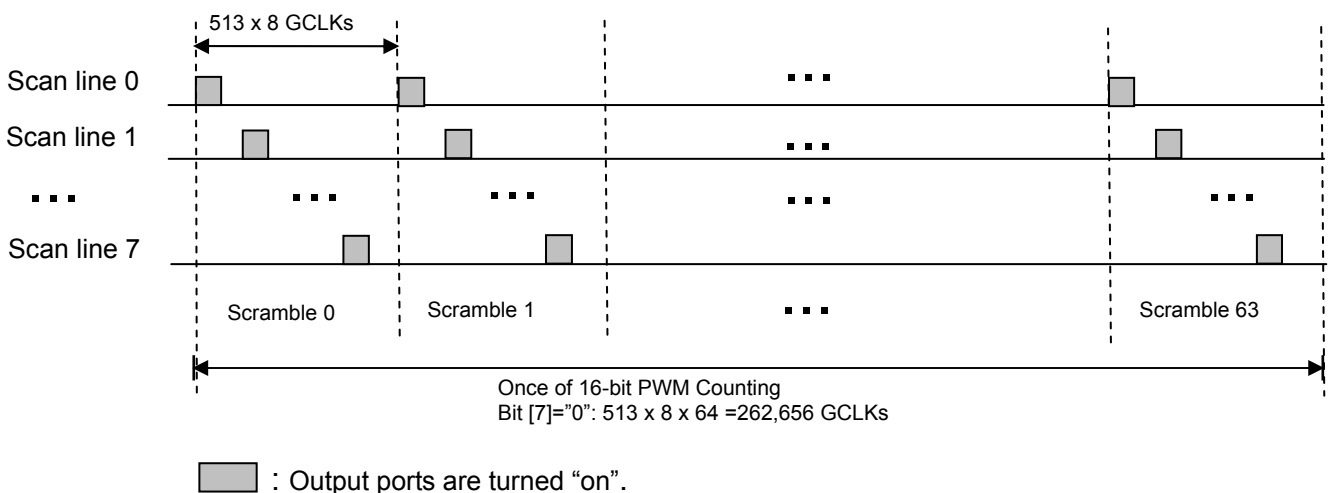

Operation Principles

Scan type application structure

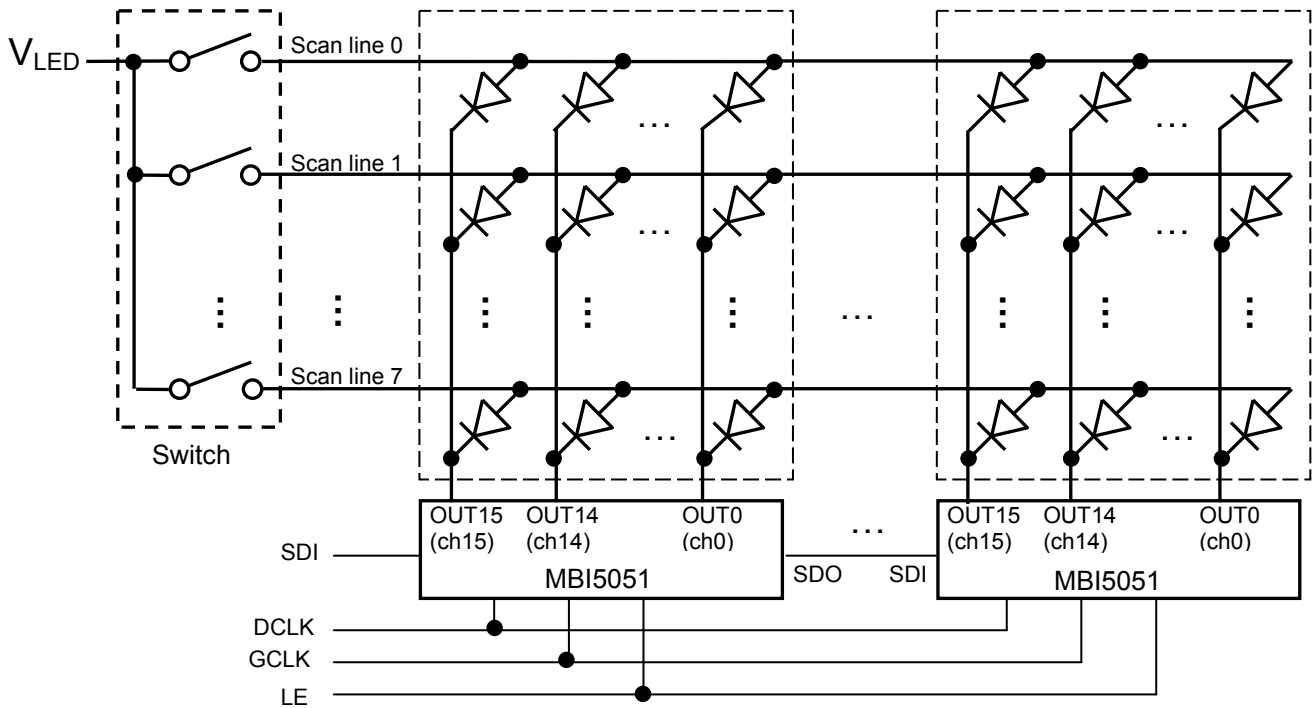

The above figure shows the suggested application structure of scan type scheme with 16 scan lines. The gray-scale data are sent by pin “SDI and SDO” with the commands formed by pin “LE” and “DCLK”. The output ports from 16 channels (OUT0~OUT15) will output the PWM result for each scan line at different time, so there must be one “Switch” to multiplex for each scan line. The switching sequence and method and the command usage will be described in the application note.

Constant Current

In LED display application, MBI5051 provides nearly no variation in current from channel to channel and from IC to IC. This can be achieved by:

- 1) The maximum current variation between channels is less than 2.5%, and that between ICs is less than ±3%
- 2) In addition, the current characteristic of output stage is flat and user can refer to the figure below. The output current can be kept constant regardless of the variations of LED forward voltages ( $V_F$ ). This guarantees LED to be performed on the same brightness as user's specification.

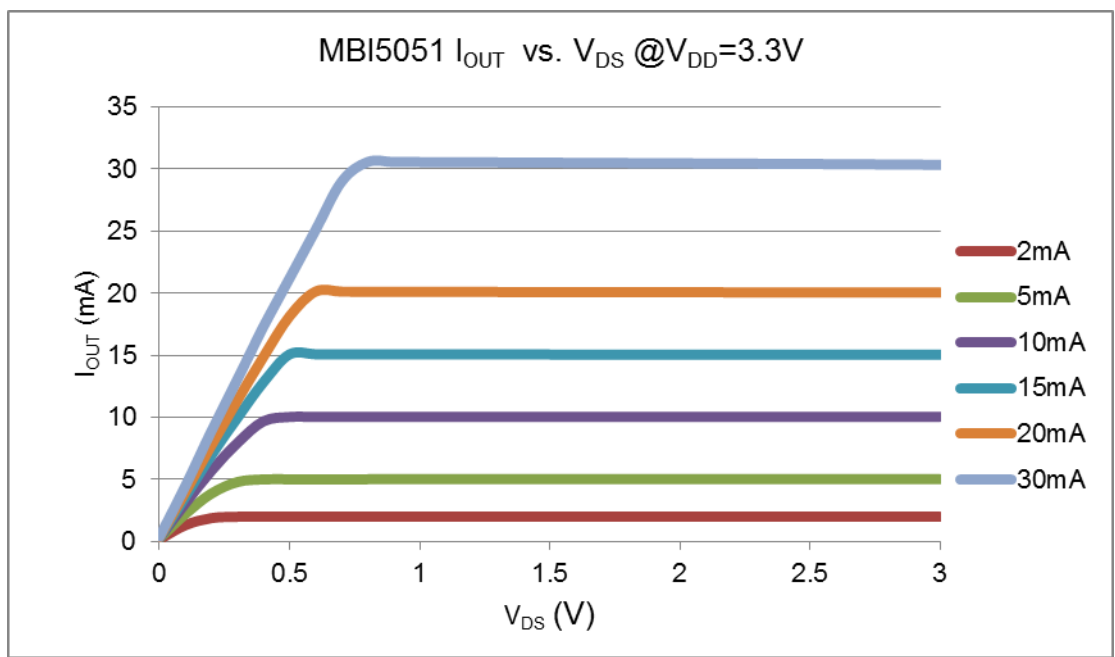
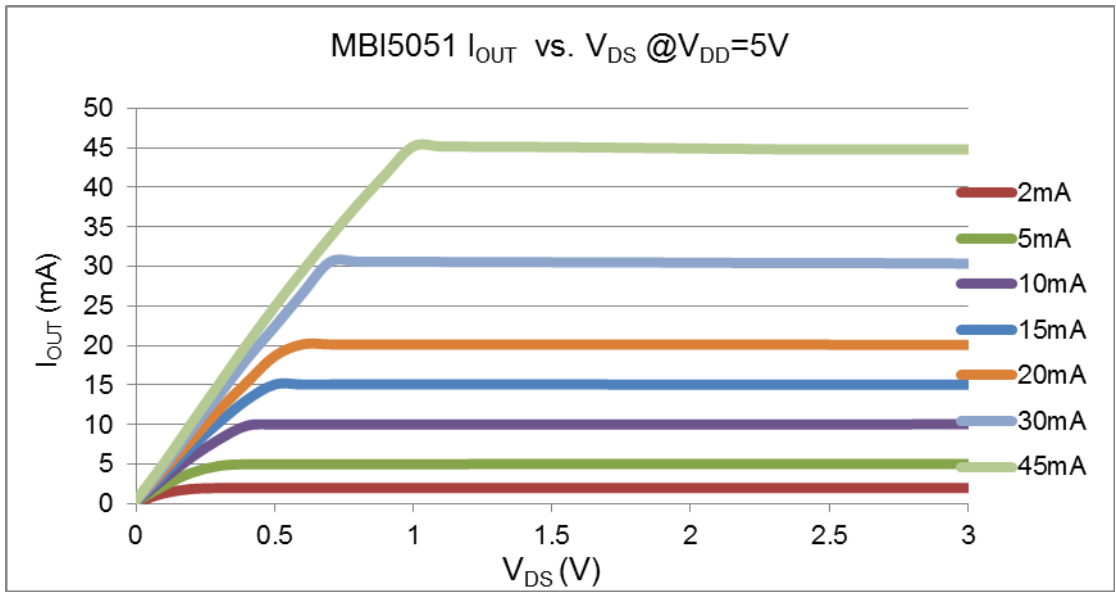

Setting Output Current

The output current ( $I_{OUT}$ ) is set by an external resistor,  $R_{EXT}$ . The default relationship between  $I_{OUT}$  and  $R_{EXT}$  is shown in the following figure.

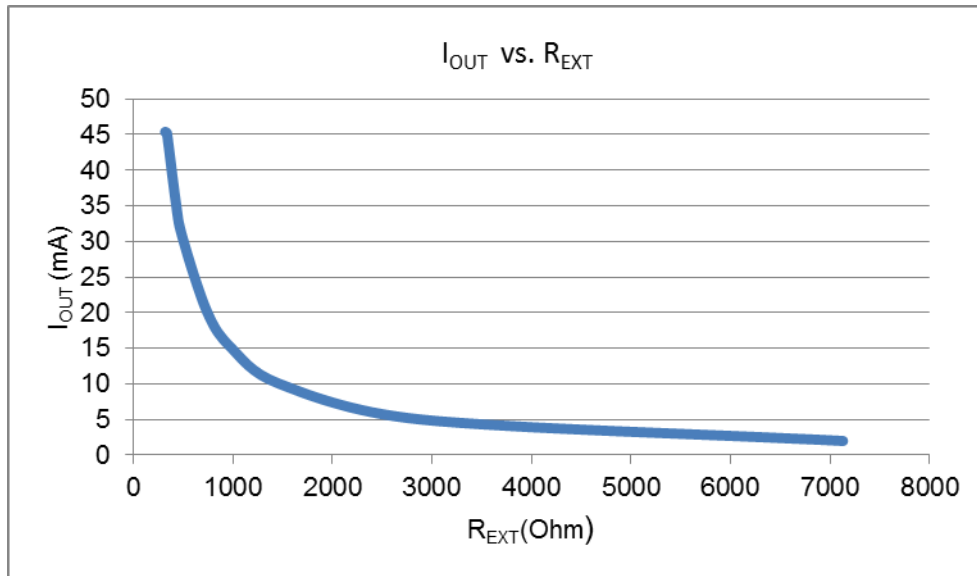

Also, the output current can be calculated from the equation:

$$V_{R-EXT} = 0.6\text{Volt} \times G; I_{OUT} = (V_{R-EXT}/R_{ext}) \times G \times 24$$

Whereas  $R_{ext}$  is the resistance of the external resistor connected to R-EXT terminal and  $V_{R-EXT}$  is its voltage. G is the digital current gain, which is set by the bit5 – bit0 of the configuration register. The default value of G is 1. The formula and setting for G are described in next section.

Current Gain Adjustment

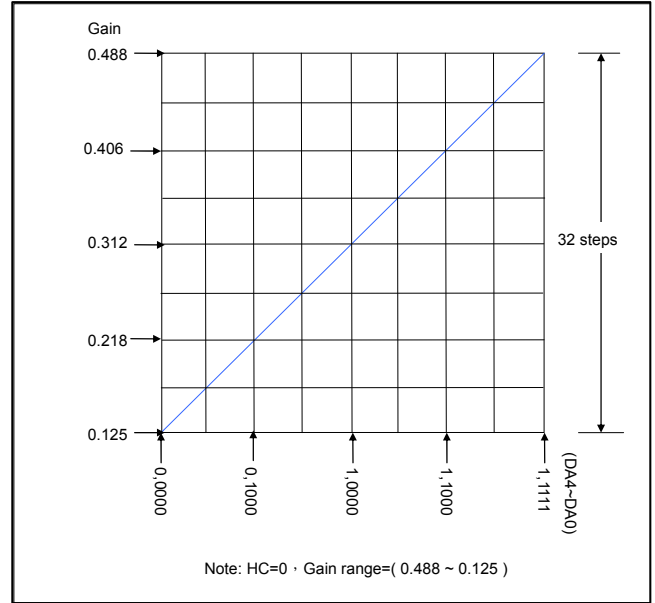
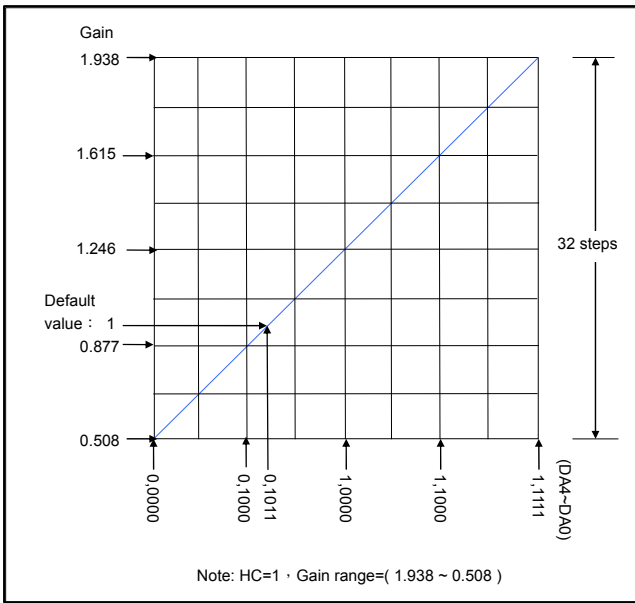

The 6 bits (bit 5~bit 0) of the configuration register set the gain of output current, i.e., G. As total 6-bit in number, i.e., ranging from 6'b000000 to 6'b111111, these bits allow user to set the output current gain up to 64 levels. These bits can be further defined inside configuration register as follows:

F	E	D	C	B	A	9	8	7	6	5	4	3	2	1	0
-	-	-	-	-	-	-	-	-	-	HC	DA4	DA3	DA2	DA1	DA0

1. Bit 5 is HC bit. The setting is in low current band when HC=0, and in high current band when HC=1.
2. Bit 4 to bit 0 are DA4 ~ DA0.

The relationship between these bits and current gain G is:

$$HC=1, D=(65 \times G - 33) / 3$$

$$HC=0, D=(256 \times G - 32) / 3$$

and D in the above decimal numeration can be converted to its equivalent in binary form by the following equation:

$$D = DA4 \times 2^4 + DA3 \times 2^3 + DA2 \times 2^2 + DA1 \times 2^1 + DA0 \times 2^0$$

In other words, these bits can be looked as a floating number with 1-bit exponent HC and 5-bit mantissa DA4~DA0.

For example,

$$HC=1, G=1.246, D=(65 \times 1.246 - 33) / 3 = 16$$

the D in binary form would be:

$$D=16 = 1 \times 2^4 + 0 \times 2^3 + 0 \times 2^2 + 0 \times 2^1 + 0 \times 2^0$$

The 6 bits (bit 5~bit 0) of the configuration register are set to 6'b110000.

Package Power Dissipation (PD)

The maximum allowable package power dissipation is determined as  $P_D(max)=(T_j-T_a)/R_{th(j-a)}$ . When 16 output channels are turned on simultaneously, the actual package power dissipation is

$P_D(act)=(I_{DD} \times V_{DD})+(I_{OUT} \times Duty \times V_{DS} \times 16)$ . Therefore, to keep  $P_D(act) \leq P_D(max)$ , the allowable maximum output current as a function of duty cycle is:

$$I_{OUT} = \{[(T_j - T_a) / R_{th(j-a)}] - (I_{DD} \times V_{DD})\} / V_{DS} / Duty / 16, \text{ where } T_j = 150^\circ\text{C}.$$

Please see the follow table for  $P_D$  and  $R_{th(j-a)}$  for different packages:

Device Type	$R_{th(j-a)}$ ( $^\circ\text{C/W}$ )	$P_D$ (W)
GP	69.50	1.79
GFN	39.15	3.19

The maximum power dissipation,  $P_D(max)=(T_j-T_a)/R_{th(j-a)}$ , decreases as the ambient temperature increases.

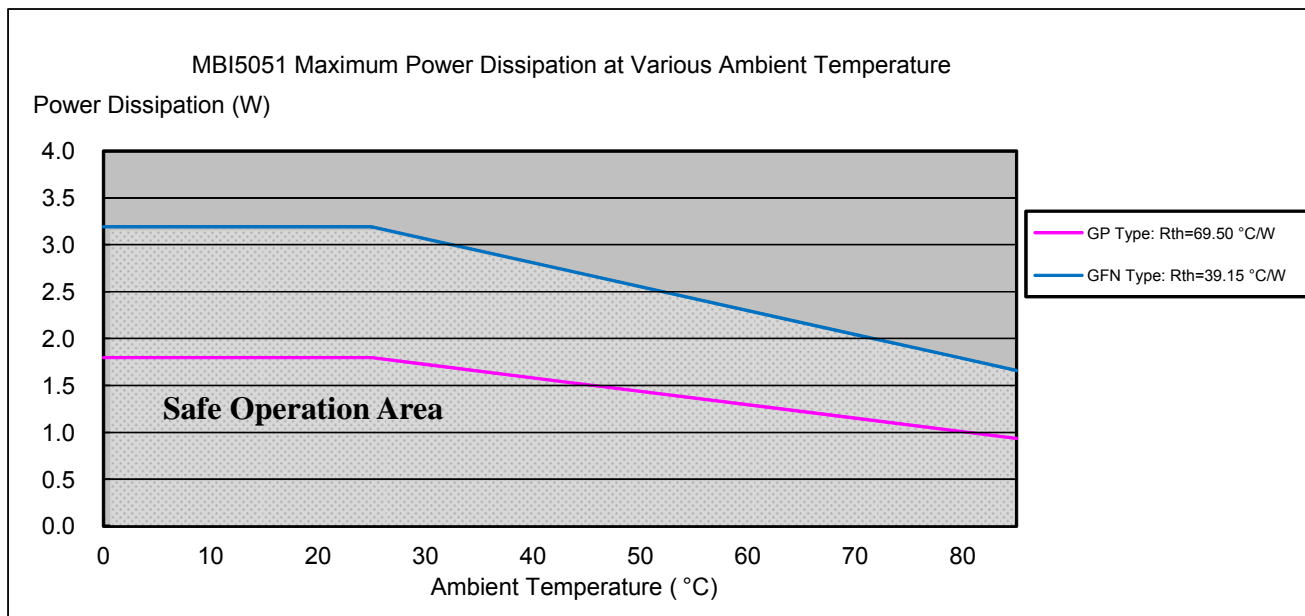

LED Supply Voltage ( $V_{LED}$ )

MBI5051 is designed to operate with  $V_{DS}$  ranging from 0.4V to 1.0V (depending on  $I_{OUT}=0.5\sim 20mA$ ) considering the package power dissipating limits.  $V_{DS}$  may be higher enough to make  $P_{D (act)} > P_{D (max)}$  when  $V_{LED}=5V$  and  $V_{DS}=V_{LED}-V_F$ , in which  $V_{LED}$  is the load supply voltage. In this case, it is recommended to use the lowest possible supply voltage or to set an external voltage reducer,  $V_{DROP}$ .

A voltage reducer lets  $V_{DS}=(V_{LED}-V_F)-V_{DROP}$ .

Resistors or Zener diode can be used in the applications as shown in the following figures.

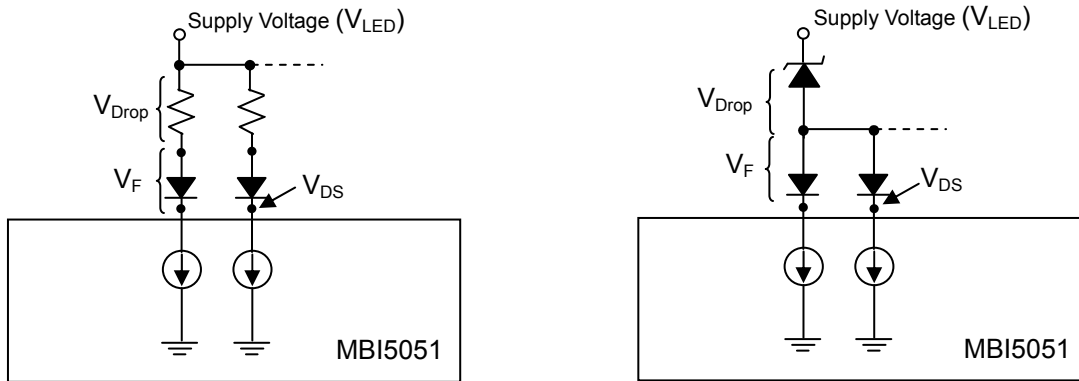

Figure 5

Switching Noise Reduction

LED drivers are frequently used in switch-mode applications which always behave with switching noise due to the parasitic inductance on PCB. To eliminate switching noise, refer to “Application Note for 8-bit and 16-bit LED Drivers-Overshoot”.



Soldering Process of "Pb-free & Green" Package Plating\*

Macroblock has defined "Pb-Free & Green" to mean semiconductor products that are compatible with the current RoHS requirements and selected 100% pure tin (Sn) to provide forward and backward compatibility with both the current industry-standard SnPb-based soldering processes and higher-temperature Pb-free processes. Pure tin is widely accepted by customers and suppliers of electronic devices in Europe, Asia and the US as the lead-free surface finish of choice to replace tin-lead. Also, it adopts tin/lead (SnPb) solder paste, and please refer to the JEDEC J-STD-020C for the temperature of solder bath. However, in the whole Pb-free soldering processes and materials, 100% pure tin (Sn) will all require from 245oC to 260oC for proper soldering on boards, referring to JEDEC J-STD-020C as shown below.

For managing MSL3 Package, it should refer to JEDEC J-STD-020C about floor life management & refer to JEDEC J-STD-033C about re-bake condition while IC's floor life exceeds MSL3 limitation.

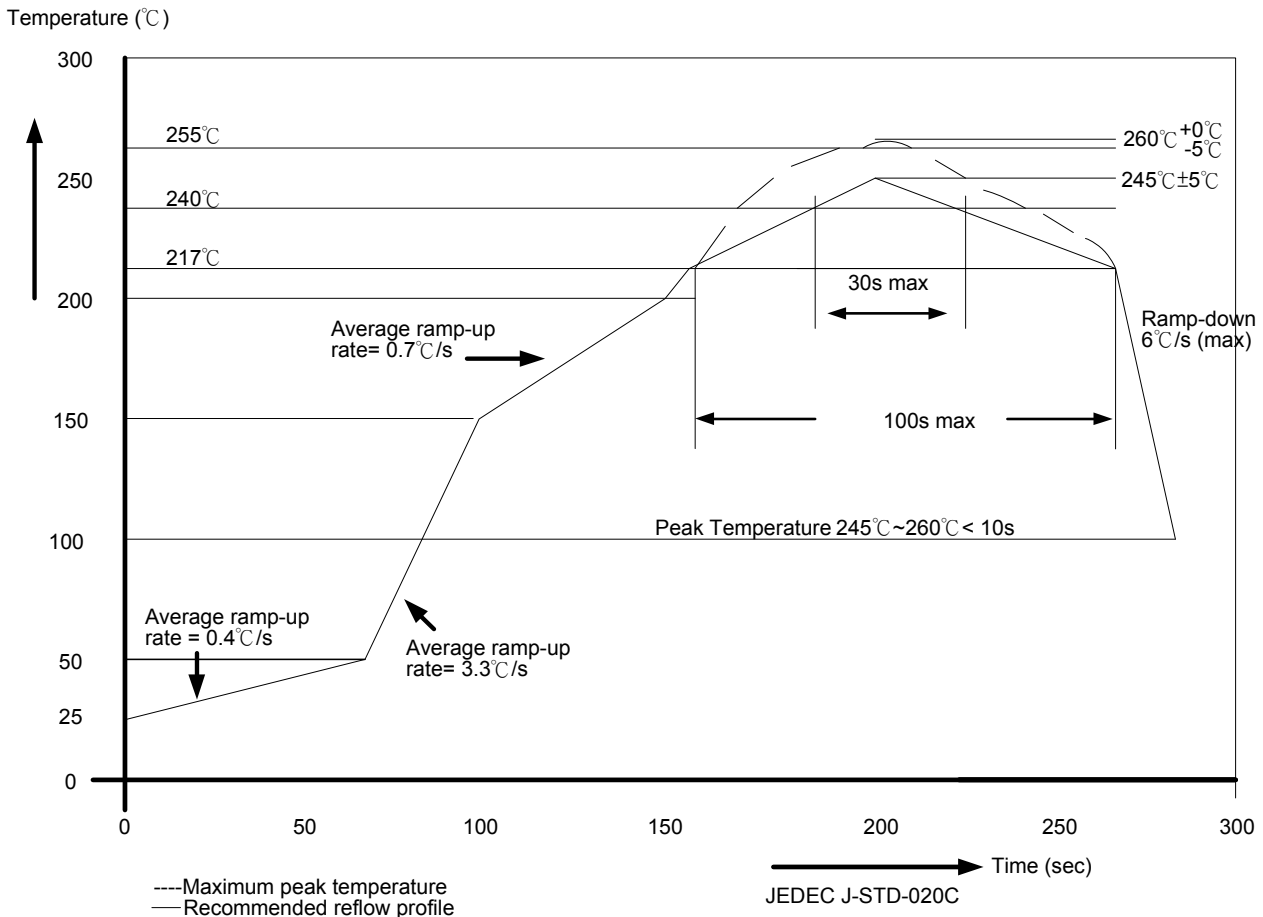

Package Thickness	Volume mm <sup>3</sup> <350	Volume mm <sup>3</sup> 350-2000	Volume mm <sup>3</sup> ≥2000
<1.6mm	260 +0 °C	260 +0 °C	260 +0 °C
1.6mm – 2.5mm	260 +0 °C	250 +0 °C	245 +0 °C
≥2.5mm	250 +0 °C	245 +0 °C	245 +0 °C

\*Note: For details, please refer to Macroblock's "Policy on Pb-free & Green Package".

Package Outline

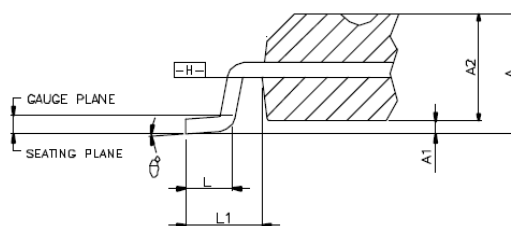
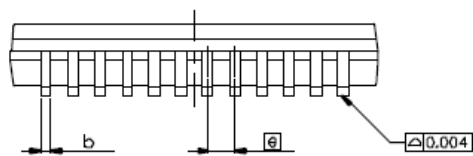
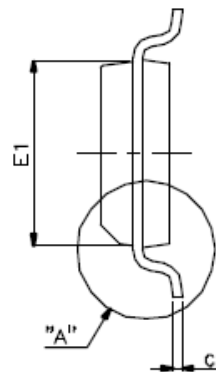
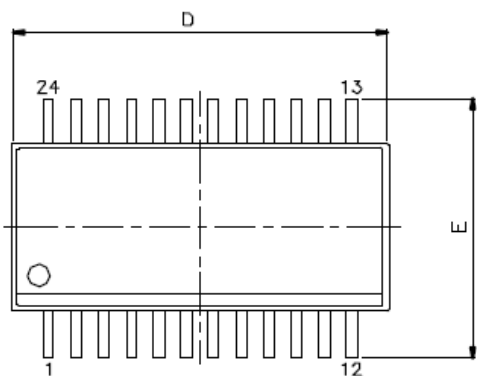

SYMBOLS	Dimensions shown in <b>inches</b>			Dimensions shown in <b>millimeters</b>		
	MIN.	NOM.	MAX	MIN.	NOM.	MAX
A	0.053	0.064	0.069	1.346	1.626	1.753
A1	0.004	0.006	0.010	0.102	0.152	0.254
A2	—	—	0.059	—	—	1.499
D	0.337	0.341	0.344	8.560	8.661	8.738
E	0.228	0.236	0.244	5.791	5.994	6.198
E1	0.150	0.154	0.157	3.810	3.912	3.988
b	0.008	—	0.012	0.203	—	0.305
c	0.007	—	0.010	0.178	—	0.254
L	0.016	0.025	0.050	0.406	0.635	1.270
e	0.025 BASIC			0.635 BASIC		
L1	0.041 BASIC			1.0414 BASIC		
θ°	0	—	8	0	—	8

MBI5051 GP Outline Drawing

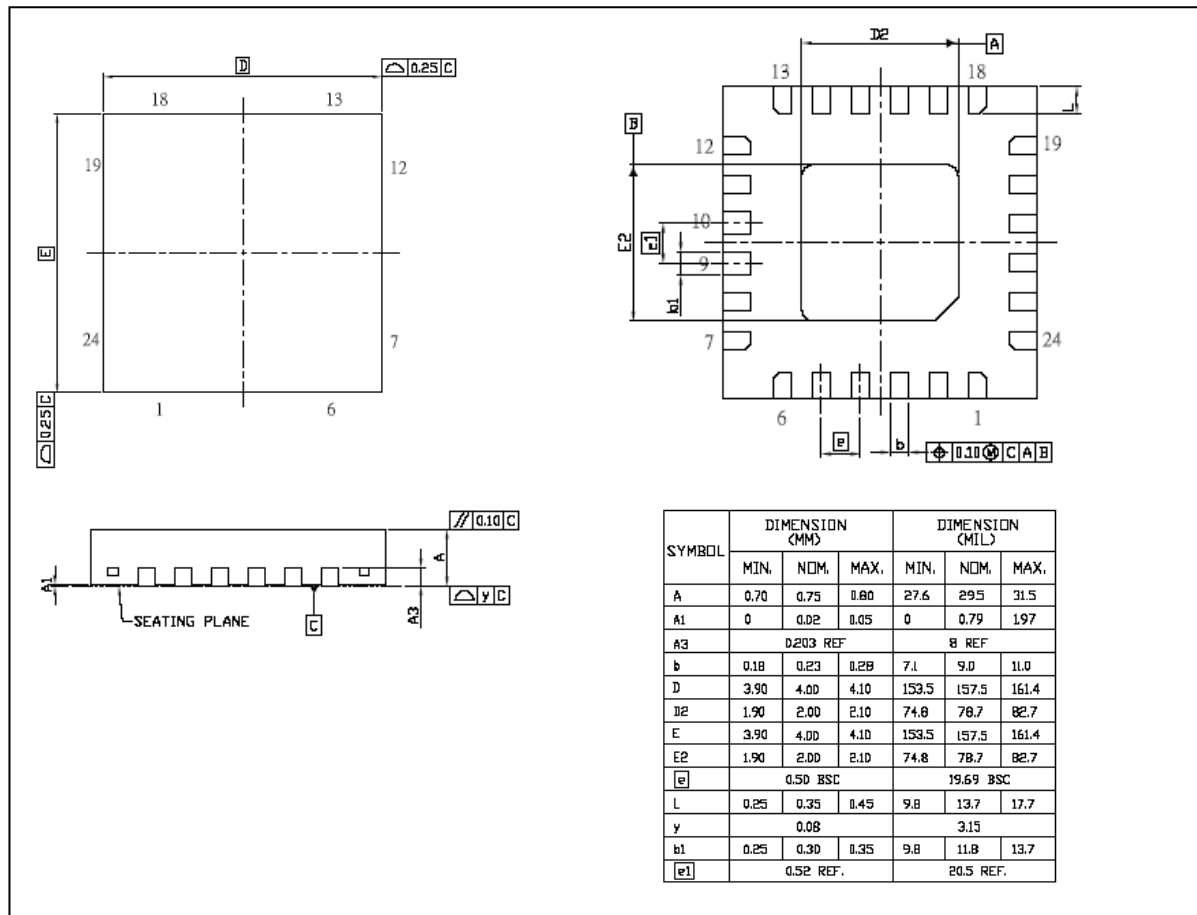

MBI5051GFN Outline Drawing

Product Top Mark Information

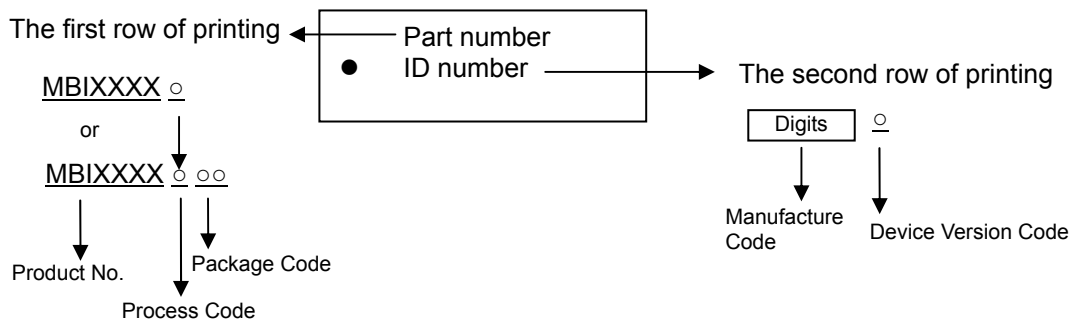

Product Revision History

Datasheet Version	Devisе Version Code
V1.00	A
V1.01	A
V1.02	A
V2.00	B
V2.01	B

Product Ordering Information

Product Ordering Number*	RoHS Compliant Package Type	Weight (g)
MBI5051GP-B	SSOP24L-150-0.64	0.11
MBI5051GFN-B	QFN24L-4*4-0.5	0.0379

\*Please place your order with the “**product ordering number**” information on your purchase order (PO).

# 16-Channel PWM Constant Current LED Driver for 1:8 Time-multiplexing Applications Disclaimer

Macroblock reserves the right to make changes, corrections, modifications, and improvements to their products and documents or discontinue any product or service. Customers are advised to consult their sales representative for the latest product information before ordering. All products are sold subject to the terms and conditions supplied at the time of order acknowledgement, including those pertaining to warranty, patent infringement, and limitation of liability. Macroblock's products are not designed to be used as components in device intended to support or sustain life or in military applications. Use of Macroblock's products in components intended for surgical implant into the body, or other applications in which failure of Macroblock's products could create a situation where personal death or injury may occur, is not authorized without the express written approval of the Managing Director of Macroblock. Macroblock will not be held liable for any damages or claims resulting from the use of its products in medical and military applications.

Related technologies applied to the product are protected by patents. All text, images, logos and information contained on this document is the intellectual property of Macroblock. Unauthorized reproduction, duplication, extraction, use or disclosure of the above mentioned intellectual property will be deemed as infringement.