

**SURFACE MOUNT
SCHOTTKY BARRIER RECTIFIERS**

REVERSE VOLTAGE – 50 to 60 Volts
FORWARD CURRENT – 5.0 Amperes

- FEATURES**
- For surface mounted applications
 - Metal-Semiconductor junction with guard ring
 - Epitaxial construction
 - Very Low forward voltage drop
 - High current capability
 - For use in low voltage, high frequency inverters, free wheeling, and polarity protection application
- MECHANICAL DATA**
- Case: Molded plastic
 - Case Material: Molding compound, UL Flammability classification 94V-0, (No Br. Sb. Cl.) "Halogen-free".
 - Polarity: Color band denotes cathode
 - Weight: 0.007 ounces, 0.21 grams

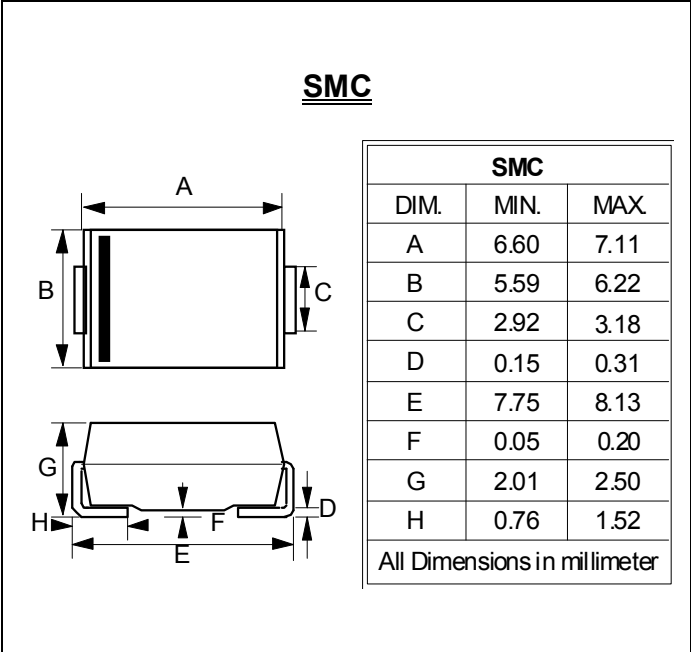

MAXIMUM RATINGS AND ELECTRICAL CHARACTERISTICS
Ratings at 25°C ambient temperature unless otherwise specified.

CHARACTERISTICS	SYMBOL	B550C	B560C	UNIT
Maximum Repetitive Peak Reverse Voltage	V _{RRM}	50	60	V
Maximum RMS Voltage	V _{RMS}	35	42	V
Maximum DC Blocking Voltage	V _{DC}	50	60	V
Maximum Average Forward Rectified Current (Note4) @TL=105°C	I _{AV}	5.0		A
Peak Forward Surge 8.3ms single half sine-wave superimposed on rated load	I _{FSM}	125		A
Maximum Forward Voltage at 5.0A DC	V _F	0.7		V
Maximum DC Reverse Current @Tj=25°C at Rated DC Blocking Voltage @Tj=100°C	I _R	0.25 20		mA
Typical Junction Capacitance (Note 1)	C _j	240		pF
Typical Thermal Resistance (Note 2, 4)	R _{θJL}	15		°C/W
Typical Thermal Resistance (Note 3, 4)	R _{θJA}	50		°C/W
Operating Junction Temperature Range	T _j	-55 to +150		°C
Storage Temperature Range	T _{STG}	-55 to +150		°C

Note: (1) Measured at 1.0MHz and applied reverse voltage of 4.0V DC...
 (2) Thermal Resistance Junction to Lead
 (3) Thermal Resistance Junction to Ambient
 (4) Unit mounted on glass epoxy substrate 1oz/ft² 30x30 mm copper pad.

**RATING AND CHARACTERISTIC CURVES
B550C thru B560C**



FIG. 1- FORWARD CURRENT DERATING CURVE

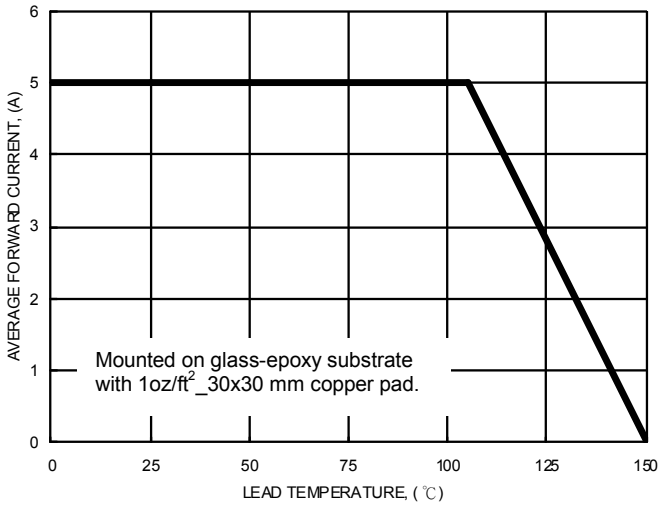

FIG. 2- MAXIMUM NON-REPETITIVE SURGE CURRENT

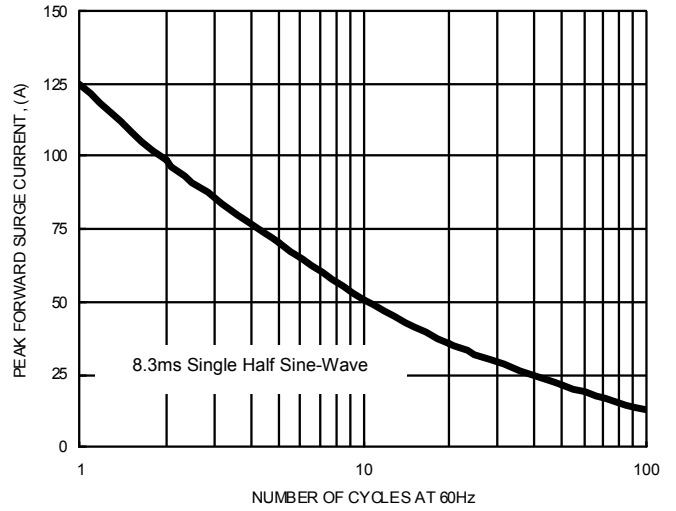

FIG. 3- TYPICAL JUNCTION CAPACITANCE

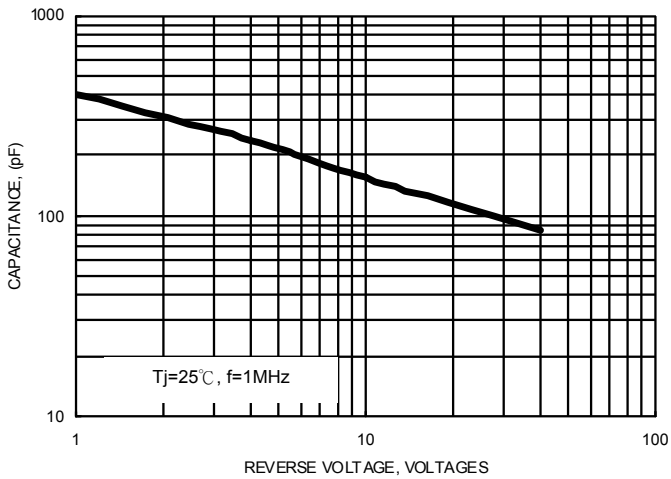

FIG. 4- TYPICAL FORWARD CHARACTERISTICS

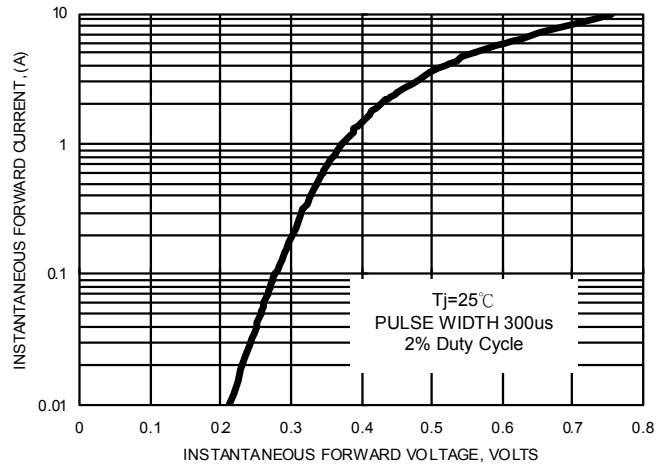

FIG. 5- TYPICAL REVERSE CHARACTERISTICS

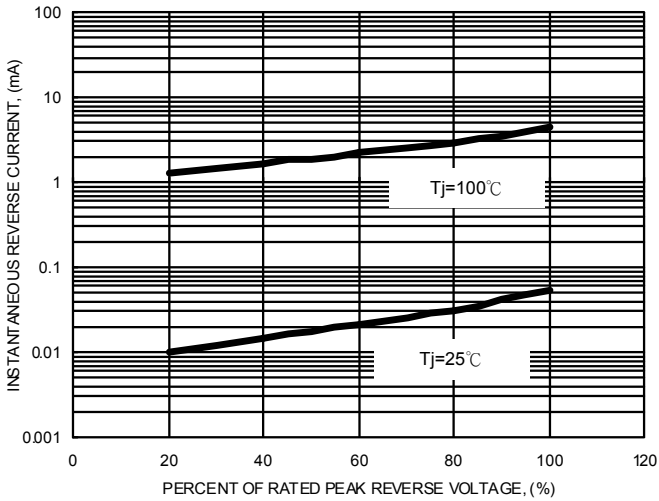
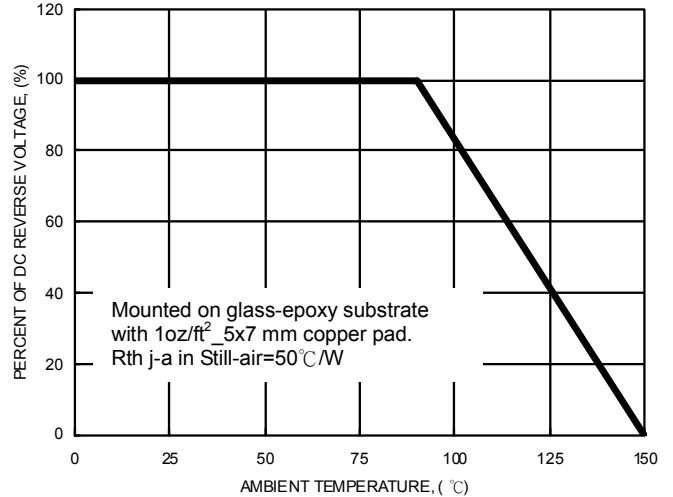

FIG. 6- DC REVERSE VOLTAGE DERATING CURVE



Important Notice and Disclaimer

LSC reserves the right to make changes to this document and its products and specifications at any time without notice. Customers should obtain and confirm the latest product information and specifications before final design, purchase or use.

LSC makes no warranty, representation or guarantee regarding the suitability of its products for any particular purpose, nor does LSC assume any liability for application assistance or customer product design. LSC does not warrant or accept any liability with products which are purchased or used for any unintended or unauthorized application.

No license is granted by implication or otherwise under any intellectual property rights of LSC.

LSC products are not authorized for use as critical components in life support devices or systems without express written approval of LSC.