

Description:

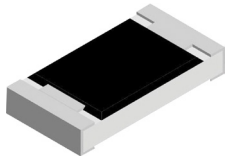

The resistors are constructed in a high grade ceramic body (aluminium oxide). Internal metal electrodes are added at each end and connected by a resistive paste that is applied to the top surface of the substrate. The composition of the paste is adjusted to give the approximate resistance required and the value is trimmed to within tolerance by laser cutting of this resistive layer.

The resistive layer is covered with a protective coat. Finally, the two external end terminations are added. For ease of soldering the outer layer of these end terminations is a Tin (lead free) alloy.

Features:

- Small size and light weight
- High reliability and stability
- Reduced size of final equipment
- High precision

Application:

- High accuracy DC-power supply
- Digital multi-meter
- Telecommunication, Computer and Automotive industry
- Medical and military equipment

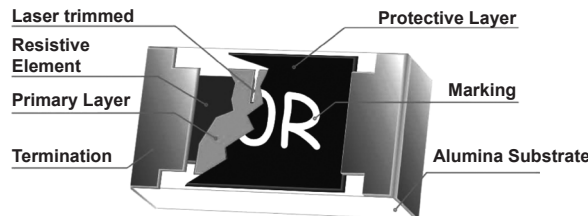

Construction of Chip-R

Quick Reference Data

Item	General Specification	
Series No.	MCWF08P	MCWF06P
Size code	0805 (2012)	0603(1608)
Resistance Tolerance	±1%, ±5%	
Resistance Range	0Ω,1Ω~ 1MΩ (E96+E24 series)	
TCR (ppm/°C) 20°C to +155°C 1Ω to 1MΩ	≤ ±100 ppm/°C	
TCR (ppm/°C) 20°C to -55°C 10Ω to 1MΩ 1Ω to 10Ω	≤ ±100 ppm/°C ≤ ±150 ppm/°C	
Max. dissipation @ T amb = 70°C	1/4 W	1/8 W
Max. Operation Voltage (DC or RMS)	150V	50V
Max. Overload Voltage (DC or RMS)	300V	100V
Climatic category (IEC 60068)	55/155/56	
Basic specification	JIS C 5201-1:1998 / IEC 60068-2-58:2004	

Note:

1. This is the maximum voltage that may be continuously supplied to the resistor element, see "IEC publication 60115-8"
2. Max. Operation Voltage : So called RCWV (Rated Continuous Working Voltage) is determined by

$$RCWV = \sqrt{\text{Rated Power} \times \text{Resistance Value}}$$
 or Max. RCWV listed above, whichever is lower.
3. 0Ω maximum resistance $R_{max} \leq 15m\Omega$ and rated current (0805) $\leq 4Amp$; (0603) $\leq 2Amp$

High Power Chip Resistor



Mechanical Data

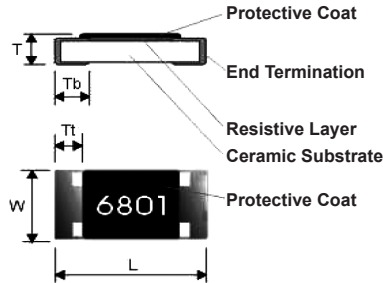

Part Number	MCWF08P	MCWF06P
L	2 ± 0.1	1.6 ± 0.1
W	1.25 ± 0.1	0.8 ± 0.1
T	0.5 ± 0.15	0.45 ± 0.15
Tb	0.4 ± 0.2	0.3 ± 0.15
Tt	0.4 ± 0.2	0.3 ± 0.1

Dimensions : Millimetres

Marking

Each resistor is marked with a three-digit (MCWF06P ±1%; ±5%; MCWF08P ±5%) or four-digit (MCWF08P ±1%) code on the protective coating to designate the nominal resistance value.

Example:

01Y = 1Ω (0603 ±1%); 103 = 10kΩ (0603 ±5%)
 1002 = 10kΩ (0805 ±1%); 102 = 1kΩ (0805 ±5%)

Functional Description:

Product characterization

Standard values of nominal resistance are taken from the E96&E24 series for resistors with a tolerance of ±1%,±5%. The values of the E96/E24 series are in accordance with "IEC publication 60063".

Derating

The power that the resistor can dissipate depends on the operating temperature.

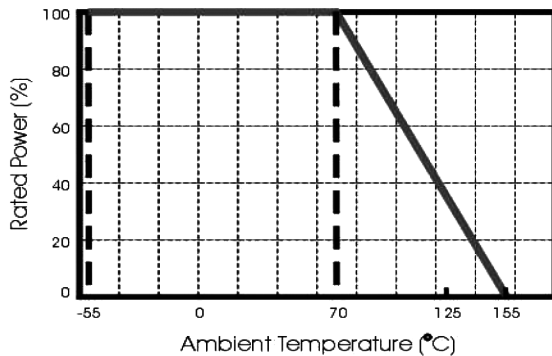

Max. Dissipation in percentage of rated power
 As a function of the ambient temperature

Mounting

Due to their rectangular shapes and small tolerances, Surface Mountable Resistors are suitable for handling by automatic placement systems.

Chip placement can be on ceramic substrates and printed-circuit boards (PCBs).

Electrical connection to the circuit is by individual soldering condition.

The end terminations guarantee a reliable contact.



High Power Chip Resistor



Soldering Condition:

The robust construction of chip resistors allows them to be completely immersed in a solder bath of 260°C for 10 seconds. Therefore, it is possible to mount Surface Mount Resistors on one side of a PCB and other discrete components on the reverse (mixed PCBs).

Surface Mount Resistors are tested for solderability at 235°C during 2 seconds. The test condition for no leaching is 260°C for 30 seconds. Typical examples of soldering processes that provide reliable joints without any damage are given in below figure.

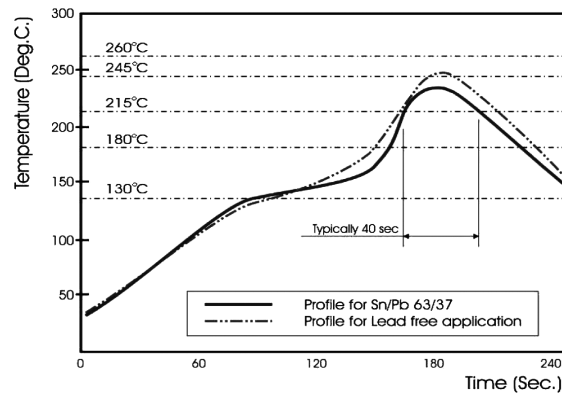

Infrared soldering profile for Chip Resistors

Catalogue Numbers:

The resistors have a catalogue number starting with

MCWFXX	P	1002	F	T	L
Size code MCWF08 : 0805 MCWF06 : 0603	Type code P : Power 0805 size = 0.25W 0603 size = 0.125W	Resistance code 5% E24: 2 significant digits followed by No. of zeros e.g.: 3Ω = 3R0 10Ω = 100 56kΩ = 563 1% E24+E96: 3 significant digits followed by No. of zeros 100Ω = 1000 37.4kΩ = 3742	Tolerance J : ±5% F : ±1% P : Jumper	Packaging code T : 7" Reeled taping paper taping 5Kpcs/reel.	Termination code L = Sn base (lead free)

Reeled tape packaging : 8mm width paper taping 5,000 pcs per 7" reel.



High Power Chip Resistor



Test And Requirements

Basic specification : JIS C 5201-1 : 1998

Test	Procedure	Requirement
Clause 4.8 Temperature Coefficient of Resistance (TCR)	Natural resistance change per change in degree Centigrade. $\frac{R_2 - R_1}{R_1(t_2 - t_1)} \times 10^6 \quad (\text{ppm}/^\circ\text{C})$ R ₁ : Resistance at reference temperature R ₂ : Resistance at test temperature t ₁ : 20°C +5°C -1°C.	Refer to quick reference data for T.C.R specification
Clause 4.13 Short time overload	5 × Rated power or Max. Overload Voltage for 5 sec. Measure resistance after 30 minutes.	ΔR/R max. J : ≤±(2% +0.1Ω) F : ≤±(1% +0.05Ω)
Clause 4.18 Resistance to soldering heat (R.S.H)	Un-mounted chips completely immersed for 10±1second in a SAC solder bath at 260°C ±5°C.	No visible damage ΔR/R max. J : ≤±(1% +0.1Ω) F : ≤±(0.5% +0.05Ω)
Clause 4.17 Solderability	Un-mounted chips completely immersed for 2 ±0.5 second in a SAC solder bath at 235°C ±5°C.	Good tinning (>95% covered) No visible damage
Clause 4.19 Temperature cycling	1. 30 minutes at -55°C ±3°C, 2. 2~3 minutes at 20°C +5°C-1°C, 3. 30 minutes at +155° ±3°C, 4. 2~3 minutes at 20°C +5°C-1°C, Total 5 continuous cycles.	No visible damage ΔR/R max. J ≤±(1%+0.1Ω) F ≤±(0.5%+0.05Ω)
Clause 4.25 Load life (endurance)	1000 +48/-0 hours, loaded with RCWV or Vmax in chamber controller 70±2°C, 1.5 hours on and 0.5 hours off.	No visible damage ΔR/R max. J ≤±(3%+0.1Ω) F ≤±(1%+0.05Ω)
Clause 4.24 Load life in Humidity	1000 +48/-0 hours, loaded with RCWV or Vmax in humidity chamber controller at 40°C±2°C and 90~95% relative humidity, 1.5 hours on and 0.5 hours off.	No visible damage ΔR/R max. J ≤±(3%+0.1Ω) F ≤±(1%+0.05Ω)
Clause 4.33 Bending strength	Resistors mounted on a 90mm glass epoxy resin PCB(FR4); bending : 3mm, once for 10 seconds.	No visible damage ΔR/R max. J ≤±(1%+0.1Ω) F ≤±(0.5%+0.05Ω)
Clause 4.32 Adhesion	Pressurizing force: 5N, Test time: 10±1sec.	No remarkable damage or removal of the terminations
Clause 4.6 Insulation Resistance	Apply the maximum overload voltage (DC) for 1 minute.	R ≥ 10GΩ
Clause 4.7 Dielectric Withstand Voltage	Apply the maximum overload voltage (AC) for 1 minute.	No breakdown or flashover

High Power Chip Resistor



Packaging:

Paper Tape specifications

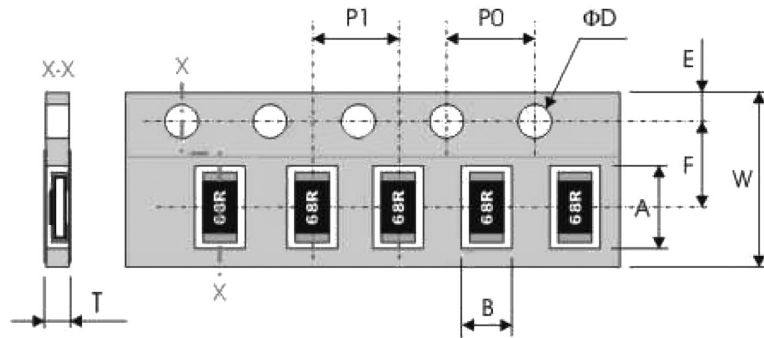

Series No.	A	B	W	F	E
MCWF06P	1.9 ±0.2	1.1 ±0.2	8 ±0.3	3.5 ±0.2	1.75 ±0.1
MCWF08P	2.4 ±0.2	1.65 ±0.2			

Series No.	P1	P0	D	T
MCWF06P	4 ±0.1	4 ±0.1	1.5 ^{+0.1} ₋₀	0.65 ±0.05
MCWF08P				Max. 1

Dimensions : Millimetres

Reel dimensions:

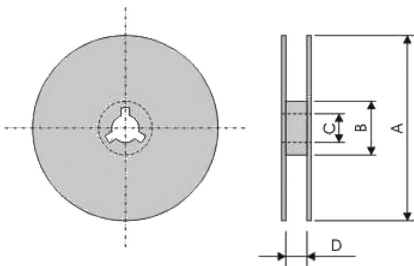

A	B	C	D
Φ178 ±2	Φ60 ±1	13 ±0.2	9 ±0.5

Dimensions : Millimetres

Important Notice : This data sheet and its contents (the "Information") belong to the members of the Premier Farnell group of companies (the "Group") or are licensed to it. No licence is granted for the use of it other than for information purposes in connection with the products to which it relates. No licence of any intellectual property rights is granted. The Information is subject to change without notice and replaces all data sheets previously supplied. The Information supplied is believed to be accurate but the Group assumes no responsibility for its accuracy or completeness, any error in or omission from it or for any use made of it. Users of this data sheet should check for themselves the Information and the suitability of the products for their purpose and not make any assumptions based on information included or omitted. Liability for loss or damage resulting from any reliance on the Information or use of it (including liability resulting from negligence or where the Group was aware of the possibility of such loss or damage arising) is excluded. This will not operate to limit or restrict the Group's liability for death or personal injury resulting from its negligence. Multicomp is the registered trademark of the Group. © Premier Farnell Limited 2016.