

FEATURES

- $V_{DS}=60V$, $I_D=0.3A$
 $R_{DS(ON)} < 3.5\Omega @ V_{GS}=5V$
 $R_{DS(ON)} < 3\Omega @ V_{GS}=10V$
ESD Rating: 1000V HBM
- High Power and Current Handling Capability
- Lead Free
- Surface Mount Package

APPLICATIONS

- Direct Logic-Level Interface: TTL/CMOS
- Drivers: Relays, Solenoids, Lamps
Hammers, Display, Memories, Transistors etc
- Battery Operated Systems
- Solid-State Relays

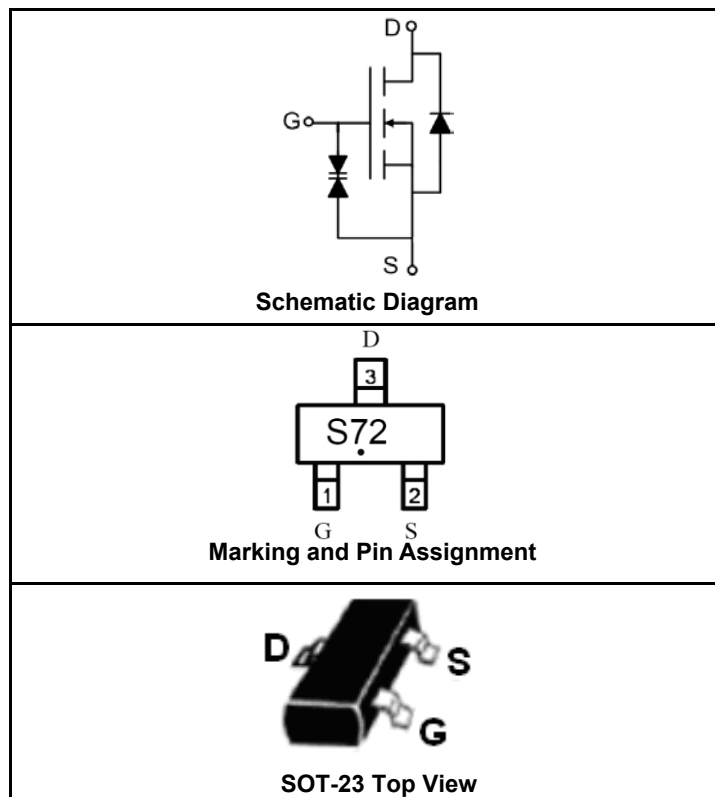

PACKAGE MARKING AND ORDERING INFORMATION

Device Marking	Device	Device Package	Reel Size	Tape width	Quantity
S72	2N7002K	SOT-23	Ø180mm	8 mm	3000 units

ABSOLUTE MAXIMUM RATINGS ($T_A=25^\circ C$ unless otherwise noted)

Parameter	Symbol	Limit	Unit
Drain-Source Voltage	V_{DS}	60	V
Gate-Source Voltage	V_{GS}	± 20	V
Drain Current-Continuous@ Current-Pulsed (Note 1)	I_D	0.3	A
	$I_D(70^\circ C)$	0.26	
		I_{DM}	0.8
Maximum Power Dissipation	P_D	0.43	W
Operating Junction and Storage Temperature Range	T_J, T_{STG}	-55 To 175	$^\circ C$

THERMAL CHARACTERISTICS

Thermal Resistance, Junction-to-Ambient (Note 2)	$R_{\theta JA}$	350	$^\circ C/W$
--	-----------------	-----	--------------

ELECTRICAL CHARACTERISTICS ($T_A=25^\circ C$ unless otherwise noted)

Parameter	Symbol	Condition	Min	Typ	Max	Unit
OFF CHARACTERISTICS						
Drain-Source Breakdown Voltage	BV_{DSS}	$V_{GS}=0V$ $I_D=250\mu A$	60			V

Zero Gate Voltage Drain Current	I_{DSS}	$V_{DS}=60V, V_{GS}=0V$			1	μA
Gate-Body Leakage Current	I_{GSS}	$V_{GS}=\pm 5V, V_{DS}=0V$			100	nA
		$V_{GS}=\pm 10V, V_{DS}=0V$			150	nA
		$V_{GS}=\pm 20V, V_{DS}=0V$			10	μA
Gate-Source Breakdown Voltage	BV_{GSO}	$V_{DS}=0V, I_G=\pm 250\mu A$	± 20			V
ON CHARACTERISTICS (Note 3)						
Gate Threshold Voltage	$V_{GS(th)}$	$V_{DS}=V_{GS}, I_D=250\mu A$	1		2.5	V
Drain-Source On-State Resistance	$R_{DS(ON)}$	$V_{GS}=10V, I_D=0.5A$			3	Ω
		$V_{GS}=5V, I_D=0.05A$			3.5	
Forward Transconductance	g_{FS}	$V_{DS}=10V, I_D=0.2A$	0.08			S
DYNAMIC CHARACTERISTICS (Note4)						
Input Capacitance	C_{iss}	$V_{DS}=25V, V_{GS}=0V,$ $F=1.0MHz$			30	PF
Output Capacitance	C_{oss}				6	PF
Reverse Transfer Capacitance	C_{rss}				3	PF
SWITCHING CHARACTERISTICS (Note 4)						
Turn-on Delay Time	$t_{d(on)}$	$V_{DD}=30V, V_{GS}=10V,$ $R_{GEN}=10\Omega, R_L=150\Omega$ $I_D=0.2A$			25	nS
Turn-Off Delay Time	$t_{d(off)}$				35	nS
Total Gate Charge	Q_g	$V_{DS}=10V, I_D=0.25A, V_{GS}=4.5V$		0.4	0.6	nC
DRAIN-SOURCE DIODE CHARACTERISTICS						
Diode Forward Voltage (Note 3)	V_{SD}	$V_{GS}=0V, I_S=0.2A$			1.3	V

NOTES:

1. Repetitive Rating: Pulse width limited by maximum junction temperature.
2. Surface Mounted on FR4 Board, $t \leq 10$ sec.
3. Pulse Test: Pulse Width $\leq 300\mu s$, Duty Cycle $\leq 2\%$.
4. Guaranteed by design, not subject to production testing.

TYPICAL ELECTRICAL AND THERMAL CHARACTERISTICS

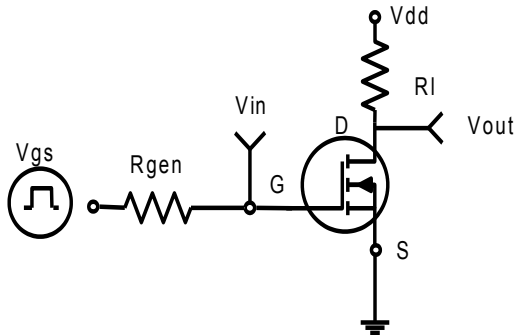

Figure 1. Switching Test Circuit

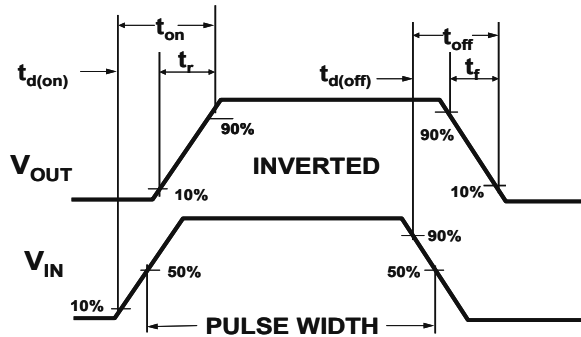

Figure 2. Switching Waveforms

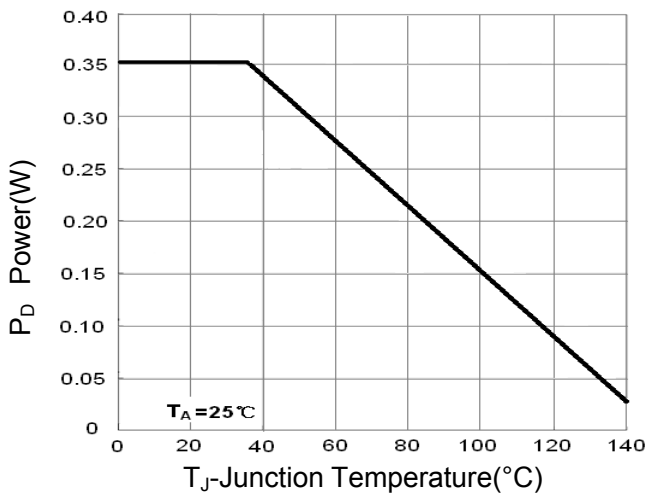

Figure 3. Power Dissipation

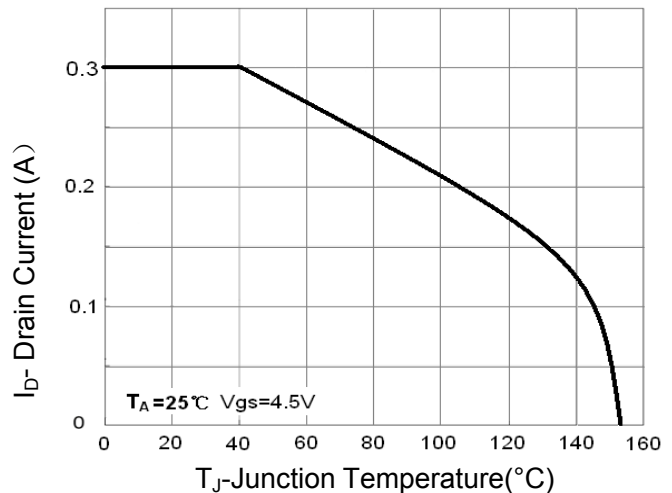

Figure 4. Drain Current

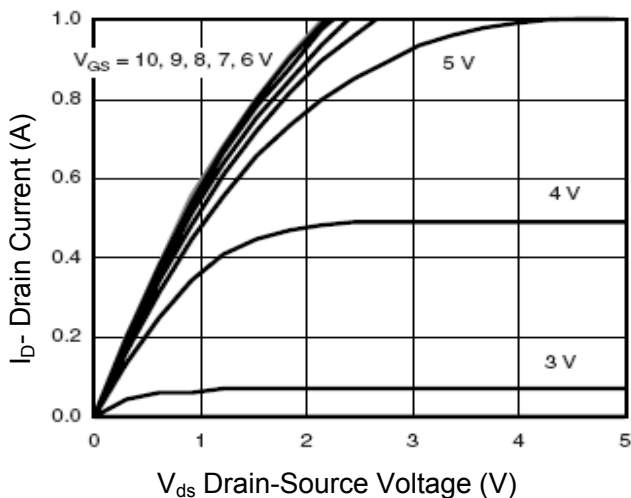

Figure 5. Output Characteristics

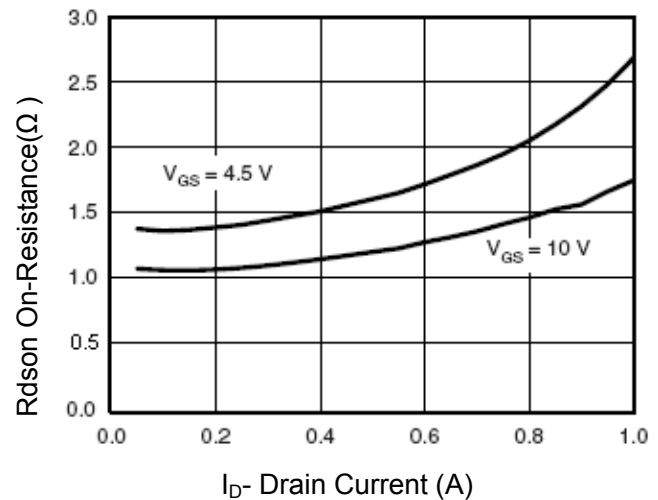

Figure 6. Drain-Source On-Resistance

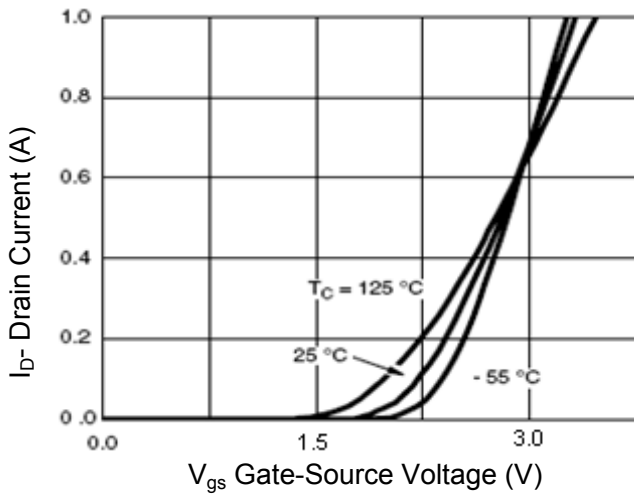

Figure 7. Transfer Characteristics

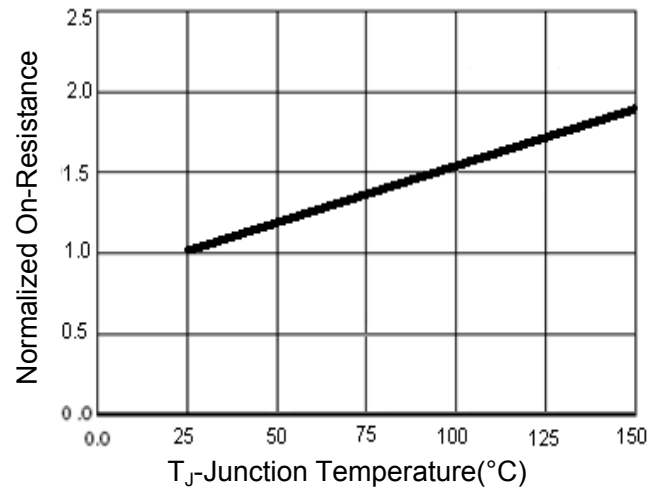

Figure 8. Drain-Source On-Resistance

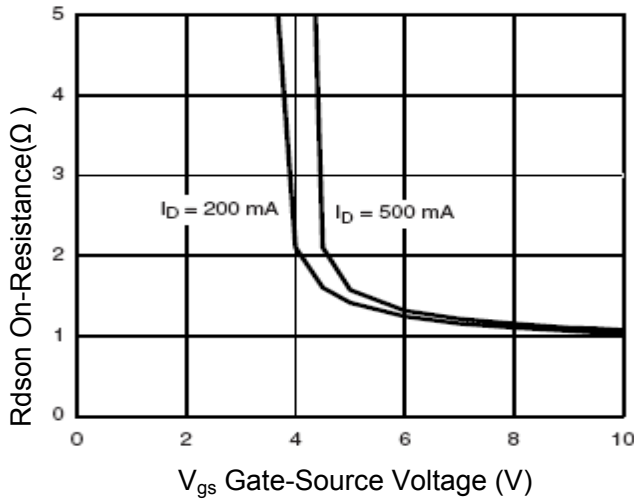

Figure 9. $R_{ds(on)}$ vs V_{gs}

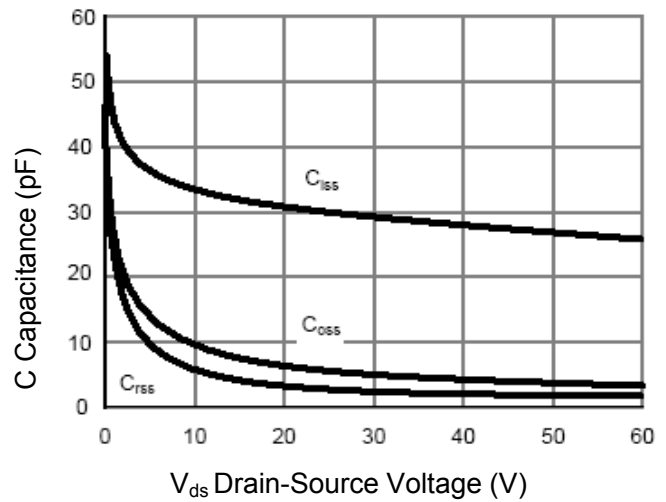

Figure 10. Capacitance vs V_{ds}

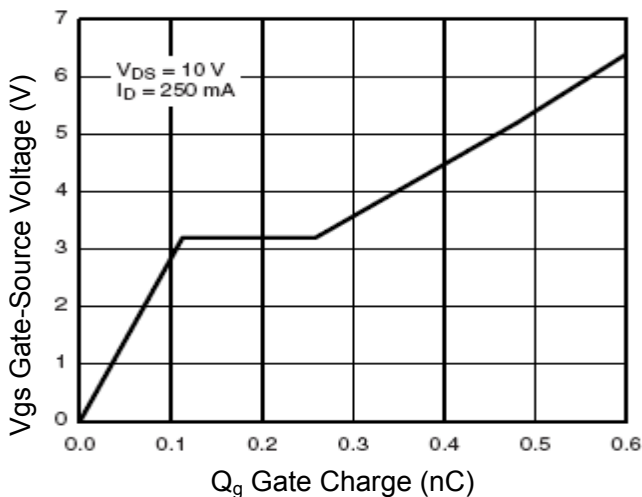

Figure 11. Gate Charge

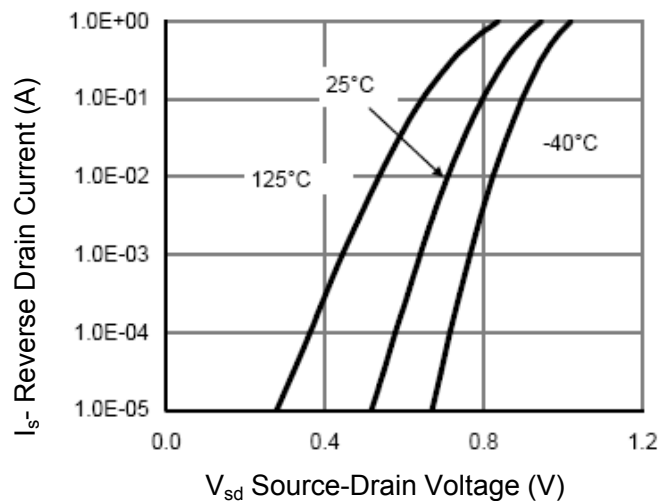

Figure 12. Source- Drain Diode Forward

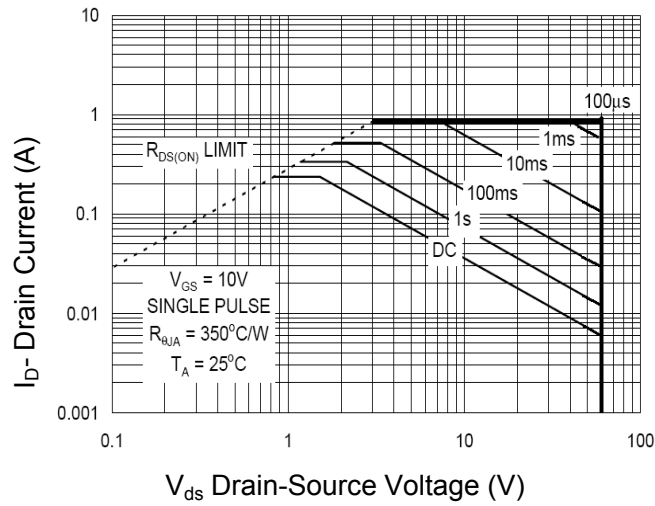

Figure 13. Safe Operation Area

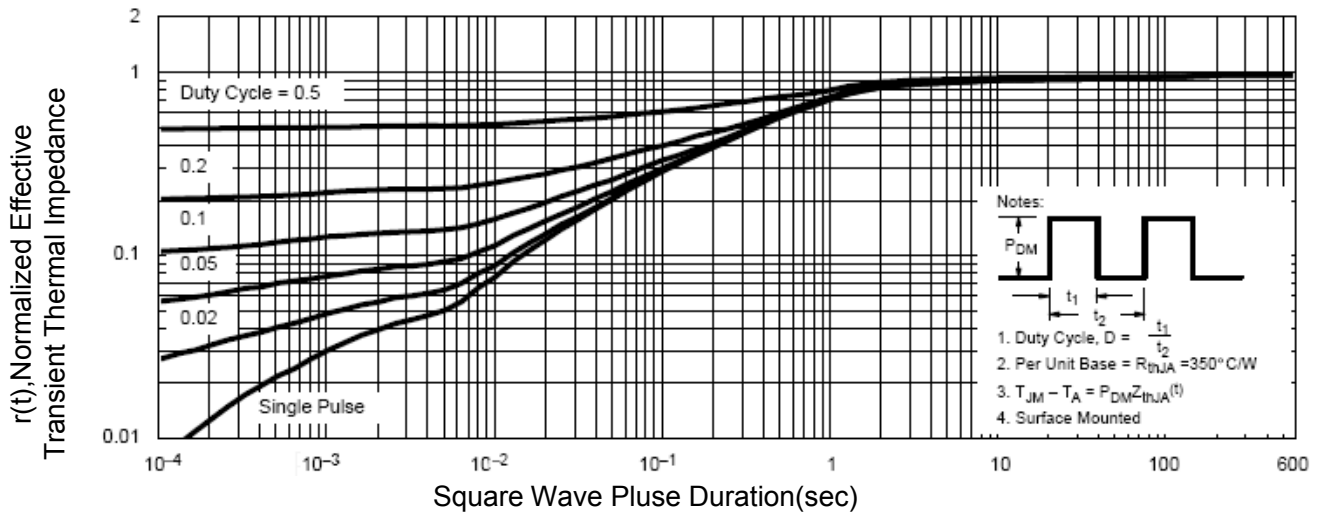
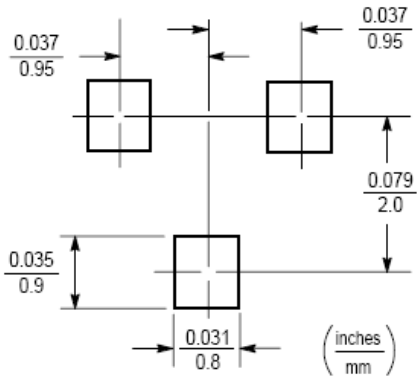
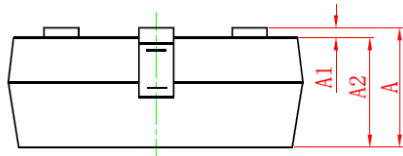
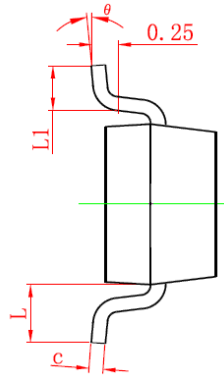
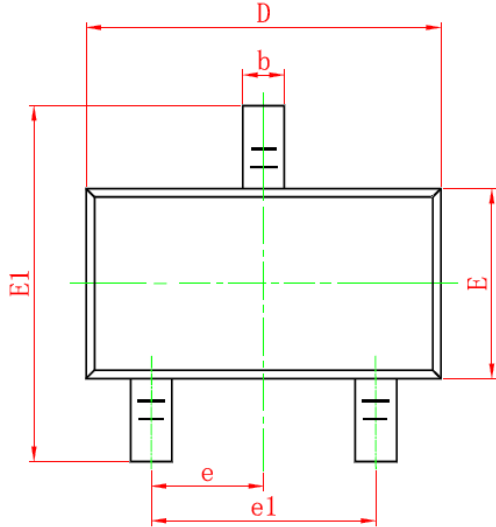

Figure 14. Normalized Maximum Transient Thermal Impedance

SOT-23 PACKAGE INFORMATION

Dimensions in Millimeters (UNIT:mm)



Symbol	Dimensions in Millimeters	
	MIN.	MAX.
A	0.900	1.150
A1	0.000	0.100
A2	0.900	1.050
b	0.300	0.500
c	0.080	0.150
D	2.800	3.000
E	1.200	1.400
E1	2.250	2.550
e	0.950TYP	
e1	1.800	2.000
L	0.550REF	
L1	0.300	0.500
θ	0°	8°

NOTES

1. All dimensions are in millimeters.
2. Tolerance $\pm 0.10\text{mm}$ (4 mil) unless otherwise specified.
3. Package body sizes exclude mold flash and gate burrs. Mold flash at the non-lead sides should be less than 5 mils.
4. Dimension L is measured in gauge plane.
5. Controlling dimension is millimeter, converted inch dimensions are not necessarily exact.