



ISOCOM
COM-

ICPLM600, ICPLM601



DESCRIPTION

The ICPLM600 and ICPLM601 devices each consists of an infrared emitting diode optically coupled to a high speed integrated photo detector logic gate.

These devices belong to Isocom Compact Range of optocouplers.

FEATURES

- High speed 10Mbit/s
- Half Pitch 1.27mm
- Common Mode Transient Immunity 5kV/ μ s min. (ICPLM601)
- High AC Isolation Voltage 3750V_{RMS}
- Guaranteed Performance from -40°C to 85°C
- Pb Free and RoHS Compliant
- Safety Approvals Pending

APPLICATIONS

- Line Receivers, Data Communication
- LSTTL to TTL, LSTTL or 5V CMOS
- Data Multiplexing
- Pulse Transformer Replacement
- Switch Mode Power Supplies
- Ground Loop Elimination
- Computer Peripheral Interface

ORDER INFORMATION

- Available in Tape and Reel with 3000pcs per reel.

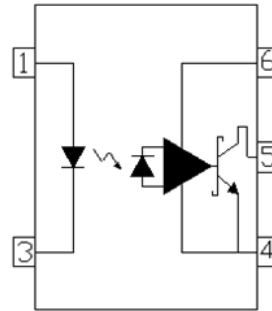

- 1 Anode
- 3 Cathode
- 4 GND
- 5 V_O
- 6 V_{CC}

V_{CC} must be bypassed by a A 0.1 μ F capacitor.

ABSOLUTE MAXIMUM RATINGS (T_A = 25°C)

Stresses exceeding the absolute maximum ratings can cause permanent damage to the device.

Exposure to absolute maximum ratings for long periods of time can adversely affect reliability.

Input

Forward Current	50mA
Reverse Voltage	5V
Power dissipation	100mW

Output

Output Current	50mA
Output Voltage	7V
Supply Voltage	7V
Power Dissipation	85mW

Total Package

Isolation Voltage	3750V _{RMS}
Operating Temperature	-40 to 85 °C
Storage Temperature	-40 to 125 °C
Lead Soldering Temperature (10s)	260°C

ISOCOM COMPONENTS 2004 LTD

Unit 25B, Park View Road West, Park View Industrial Estate
Hartlepool, Cleveland, TS25 1PE, United Kingdom
Tel : +44 (0)1429 863 609 Fax : +44 (0)1429 863 581
e-mail : sales@isocom.co.uk
<http://www.isocom.com>

ISOCOM COMPONENTS ASIA LTD

Hong Kong Office,
Block A, 8/F, Wah Hing Industrial mansion,
36 Tai Yau Street, San Po Kong, Kowloon, Hong Kong.
Tel : +852 2995 9217 Fax : +852 8161 6292
e-mail : sales@isocom.com.hk



ICPLM600, ICPLM601

Truth Table (Positive Logic)

Input	Output
H	L
L	H

ELECTRICAL CHARACTERISTICS ($T_A = -40^\circ\text{C}$ to 85°C unless otherwise specified)

INPUT

Parameter	Symbol	Test Condition	Min	Typ.*	Max	Unit
Forward Voltage	V_F	$I_F = 10\text{mA}$		1.45	1.80	V
Forward Voltage Temperature Coefficient	$\Delta V_F/\Delta T$	$I_F = 10\text{mA}$		-1.9		mV/°C
Reverse Voltage	V_R	$I_R = 10\mu\text{A}$	5.0			V
Input Capacitance	C_{IN}	$V_F = 0\text{V}$, $f = 1\text{MHz}$		70		pF

OUTPUT

Parameter	Symbol	Test Condition	Min	Typ.*	Max	Unit
High Level Supply Current	I_{CCH}	$I_F = 0\text{mA}$, $V_{CC} = 5.5\text{V}$		6.0	9	mA
Low Level Supply Current	I_{CCL}	$I_F = 10\text{mA}$, $V_{CC} = 5.5\text{V}$		7.5	10	mA
High Level Output Current	I_{OH}	$I_F = 250\mu\text{A}$, $V_{CC} = 5.5\text{V}$, $V_O = 5.5\text{V}$		2.1	30	μA
Low Level Output Voltage	V_{OL}	$I_F = 5\text{mA}$, $V_{CC} = 5.5\text{V}$, $I_{OL} = 13\text{mA}$		0.4	0.6	V

COUPLED

Parameter	Symbol	Test Condition	Min	Typ.*	Max	Unit
Input Threshold Current	I_{TH}	$V_{CC} = 5.5\text{V}$, $V_O = 0.6\text{V}$ $I_{OL} = 13\text{mA}$		2.4	5	mA

* Typical values at $T_A = 25^\circ\text{C}$



ICPLM600, ICPLM601

ELECTRICAL CHARACTERISTICS ($T_A = -40^{\circ}\text{C}$ to 85°C unless otherwise specified)

SWITCHING ($T_A = -40^{\circ}\text{C}$ to 85°C , $I_F = 7.5\text{mA}$, $V_{CC} = 5\text{V}$ unless otherwise specified)

Parameter	Symbol	Test Condition	Min	Typ.*	Max	Unit
Propagation Delay Time to Logic Low	T_{PHL}	$R_L = 350\Omega$, $C_L = 15\text{pF}$, $T_A = 25^{\circ}\text{C}$		41	100	ns
Propagation Delay Time to Logic High	T_{PLH}			50	100	
Pulse Width Distortion	$ t_{PHL}-t_{PLH} $	$R_L = 350\Omega$, $C_L = 15\text{pF}$		9	35	
Propagation Delay Skew	t_{PSK}				40	
Output Rise Time	t_r				40	
Output Fall Time	t_f				10	
Common Mode Transient Immunity at Logic High	CM_H	ICPLM600 $I_F = 0\text{mA}$, $V_{OH} = 2.0\text{V}$, $R_L = 350\Omega$, $V_{CM} = 10\text{Vp-p}$, $T_A = 25^{\circ}\text{C}$		1000		$\text{V}/\mu\text{s}$
		ICPLM601 $I_F = 0\text{mA}$, $V_{OH} = 2.0\text{V}$, $R_L = 350\Omega$, $V_{CM} = 50\text{Vp-p}$, $T_A = 25^{\circ}\text{C}$	5000			
Common Mode Transient Immunity at Logic Low	CM_L	ICPLM600 $I_F = 7.5\text{mA}$, $V_{OL} = 0.8\text{V}$, $R_L = 350\Omega$, $V_{CM} = 10\text{Vp-p}$, $T_A = 25^{\circ}\text{C}$		1000		
		ICPLM601 $I_F = 7.5\text{mA}$, $V_{OL} = 0.8\text{V}$, $R_L = 350\Omega$, $V_{CM} = 50\text{Vp-p}$, $T_A = 25^{\circ}\text{C}$	5000			

* Typical values at $T_A = 25^{\circ}\text{C}$



ISOCOM
COM-

ICPLM600, ICPLM601

ELECTRICAL CHARACTERISTICS

Notes :

1. The V_{CC} supply must be bypassed by a $0.1\mu\text{F}$ capacitor or larger with good high frequency characteristic and should be connected as close as possible to the package V_{CC} and GND pins.
2. t_{PLH} – Propagation delay is measured from the 3.75mA level on the HIGH to LOW transition of the input current pulse to the 1.5 V level on the LOW to HIGH transition of the output voltage pulse.
3. t_{PHL} – Propagation delay is measured from the 3.75mA level on the LOW to HIGH transition of the input current pulse to the 1.5 V level on the HIGH to LOW transition of the output voltage pulse.
4. t_{PSK} – The magnitude of the worst case difference in t_{PHL} and/or t_{PLH} that will be seen between devices at any given temperature within the worst case operating condition range.
4. t_r – Rise time is measured from the 10% to the 90% levels on the LOW to HIGH transition of the output pulse.
5. t_f – Fall time is measured from the 90% to the 10% levels on the HIGH to LOW transition of the output pulse.
6. CM_H – The maximum tolerable rate of rise of the common mode voltage to ensure the output will remain in the HIGH state (i.e., $V_{OUT} > 2.0\text{V}$).
7. CM_L – The maximum tolerable rate of rise of the common mode voltage to ensure the output will remain in the LOW output state (i.e., $V_{OUT} < 0.8\text{V}$).



ICPLM600, ICPLM601

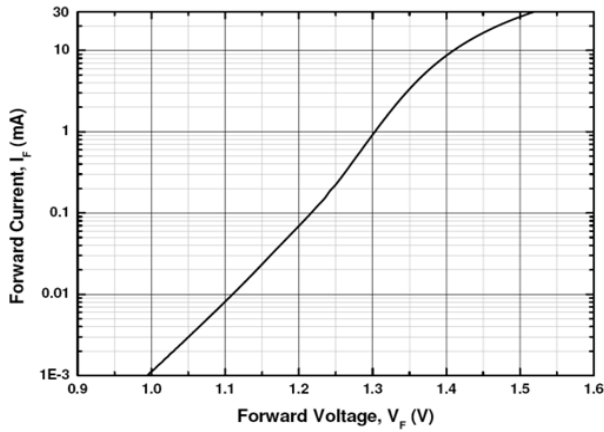

Fig 1 Forward Current vs Forward Voltage

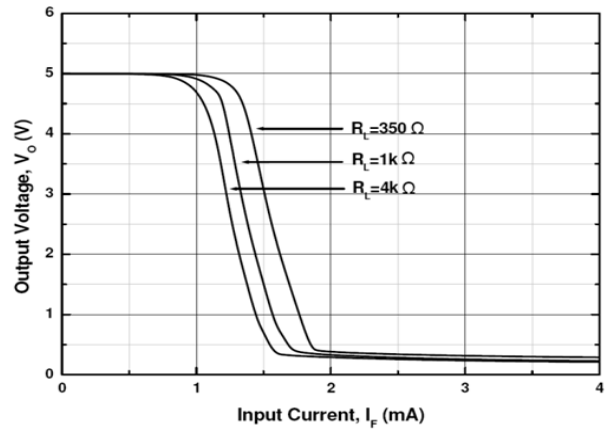

Fig 2 Output Voltage vs Forward Current

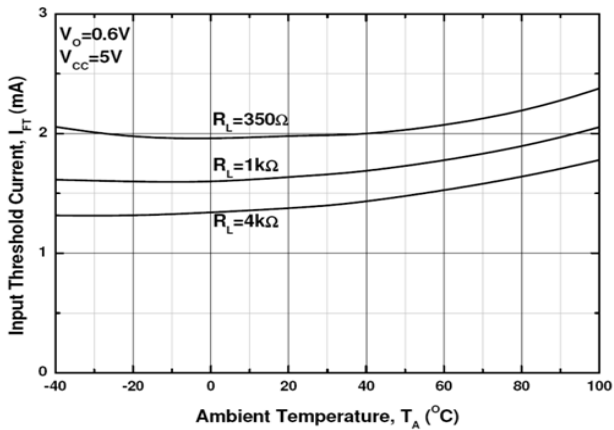

Fig 3 Input Threshold Current vs T_A

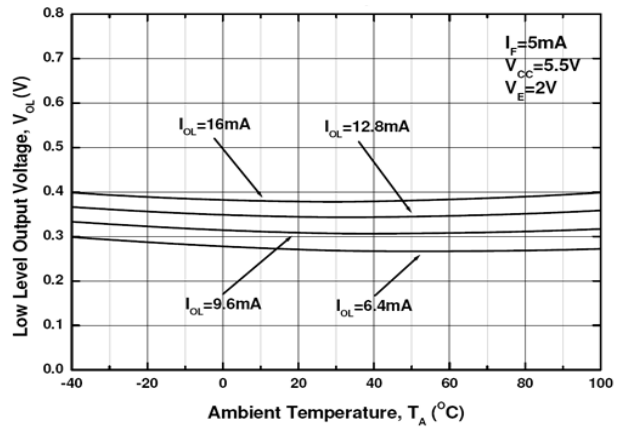

Fig 4 Low Level Output Voltage vs T_A

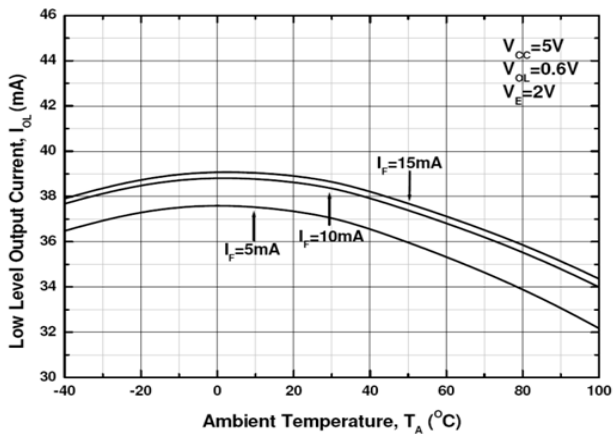

Fig 5 Low Level Output Current vs T_A

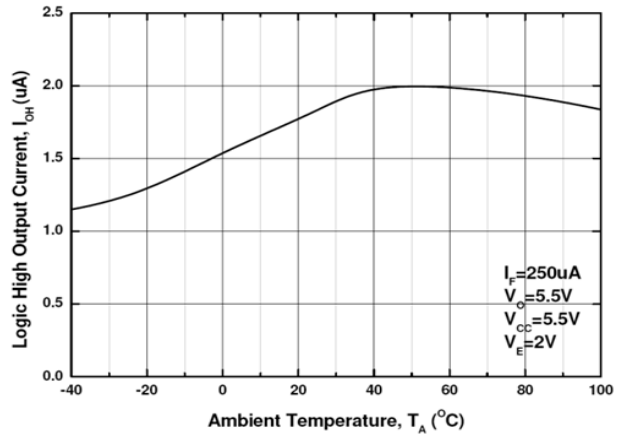

Fig 6 High Level Output Current vs T_A



ICPLM600, ICPLM601

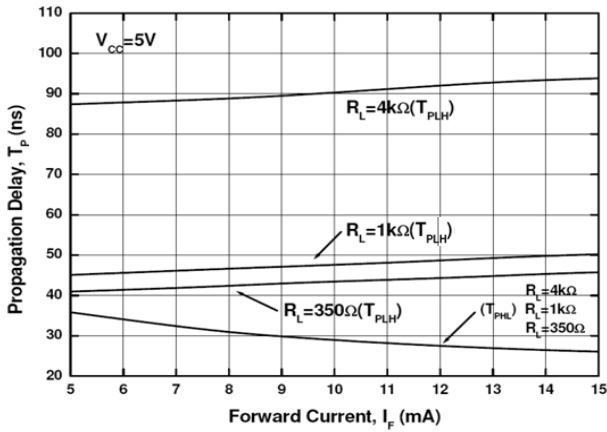

Fig 7 Propagation Delay vs Forward Current

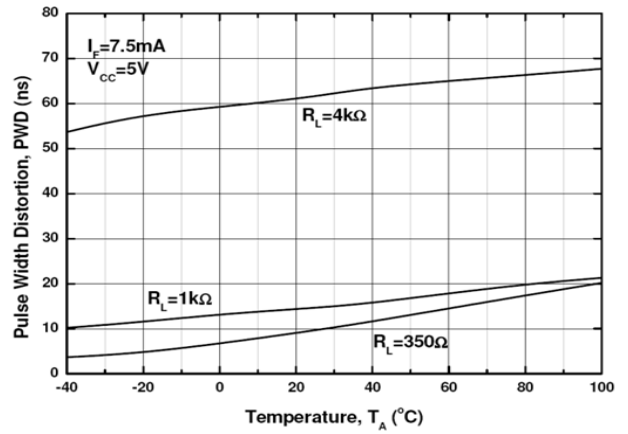

Fig 8 Pulse Width Distortion vs T_A

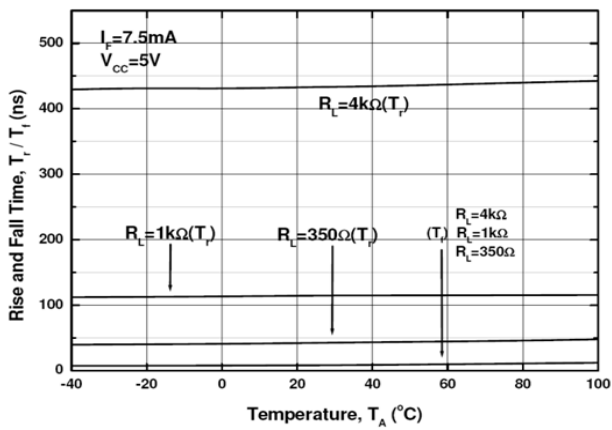
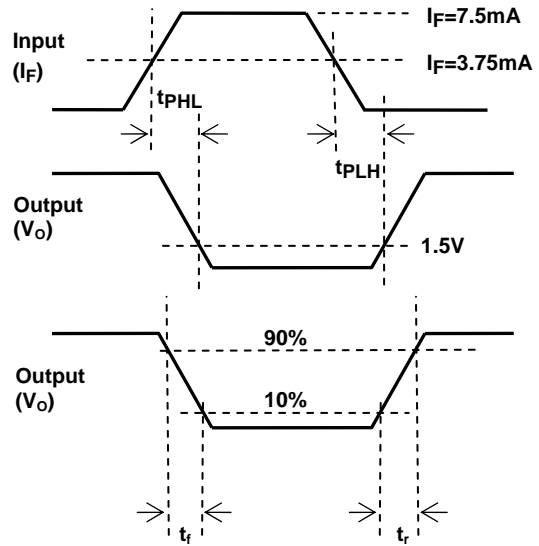
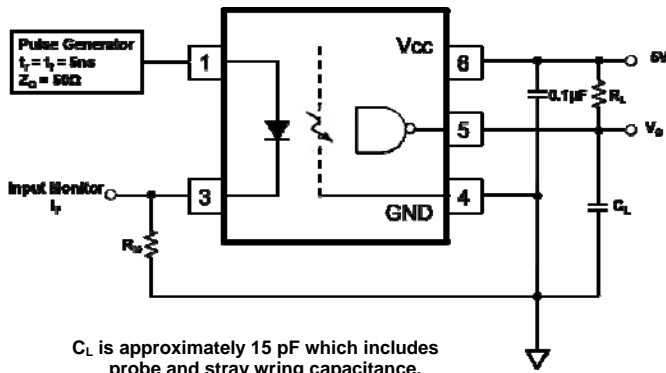

Fig 9 Rise and Fall Time vs T_A



ICPLM600, ICPLM601



Switching Time Test Circuit

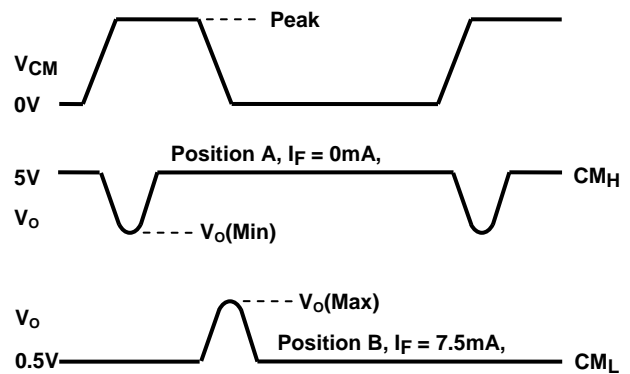
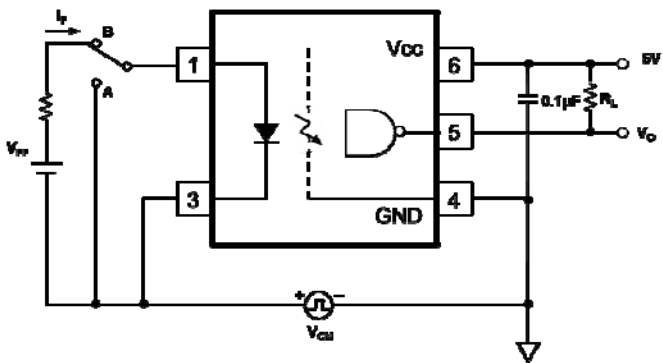

Common Mode Transient Immunity Test Circuit

Common mode transient immunity in logic high level is the maximum tolerable (positive) dV_{CM}/dt on the leading edge of the common mode pulse signal V_{CM} , to assure that the output will remain in a logic high state (i.e., $V_o > 2.0V$).

Common mode transient immunity in logic low level is the maximum tolerable (negative) dV_{CM}/dt on the trailing edge of the common mode pulse signal, V_{CM} , to assure that the output will remain in a logic low state (i.e., $V_o < 0.8V$).



ISOCOM
COM-

ICPLM600, ICPLM601

ORDER INFORMATION

ICPLM600, ICPLM601			
After PN	PN	Description	Packing quantity
None	ICPLM600, ICPLM601	Surface Mount Tape & Reel	3000 pcs per reel

DEVICE MARKING

Example : ICPLM600

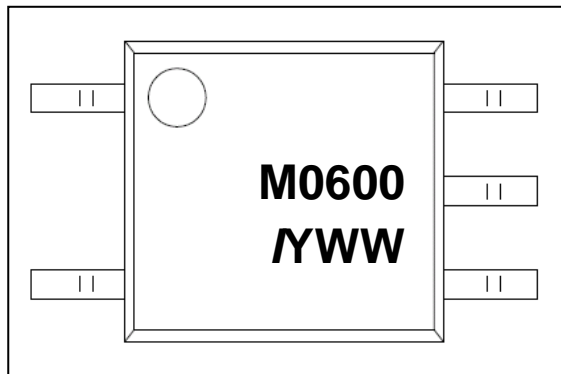

M0600 denotes Device Part Number
/ denotes Isocom
Y denotes 1 digit Year code
WW denotes 2 digit Week code



ISOCOM

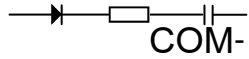

ICPLM600, ICPLM601

PACKAGE DIMENSIONS (mm)

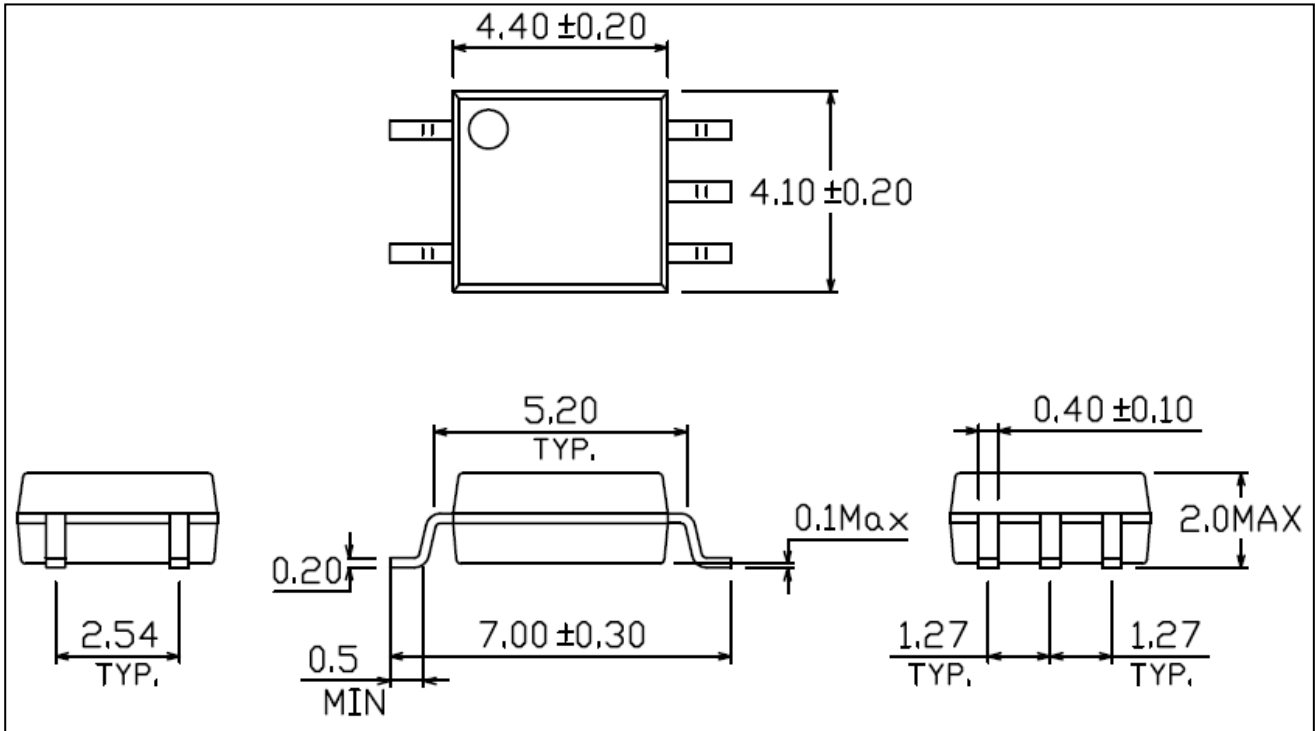

RECOMMENDED PAD LAYOUT (mm)

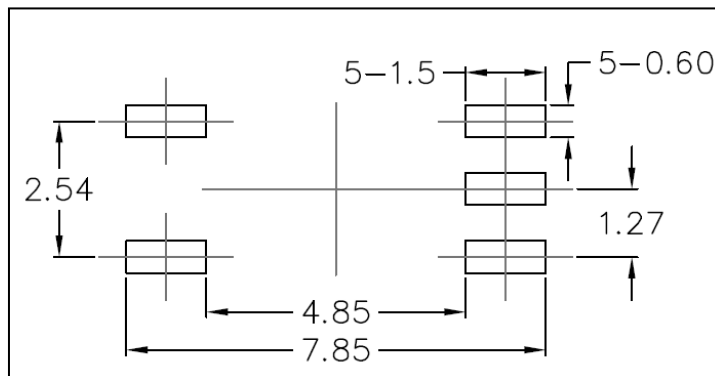



ISOCOM

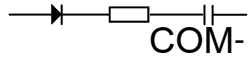

COM-

ICPLM600, ICPLM601

IR REFLOW SOLDERING TEMPERATURE PROFILE
(One Time Reflow Soldering is Recommended)

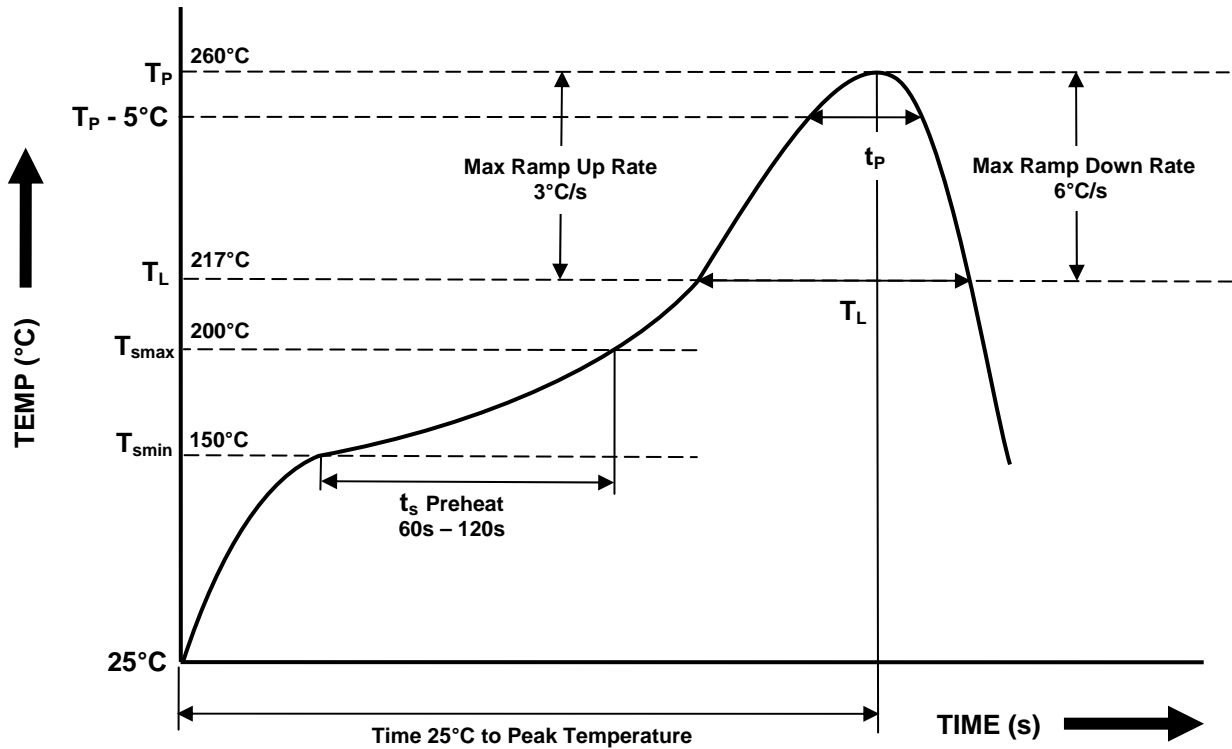

Profile Details	Conditions
Preheat - Min Temperature (T_{SMIN}) - Max Temperature (T_{SMAX}) - Time T_{SMIN} to T_{SMAX} (t_s)	150°C 200°C 60s - 120s
Soldering Zone - Peak Temperature (T_P) - Liquidous Temperature (T_L) - Time within 5°C of Actual Peak Temperature ($T_P - 5^\circ\text{C}$) - Time maintained above T_L (t_L) - Ramp Up Rate (T_L to T_P) - Ramp Down Rate (T_P to T_L)	260°C 217°C 30s 60s - 100s 3°C/s max 6°C/s max
Average Ramp Up Rate (T_{smax} to T_P)	3°C/s max
Time 25°C to Peak Temperature	8 minutes max



ICPLM600, ICPLM601

TAPE AND REEL PACKAGING

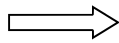
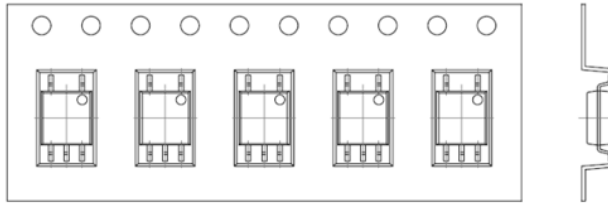

Direction of feed from reel

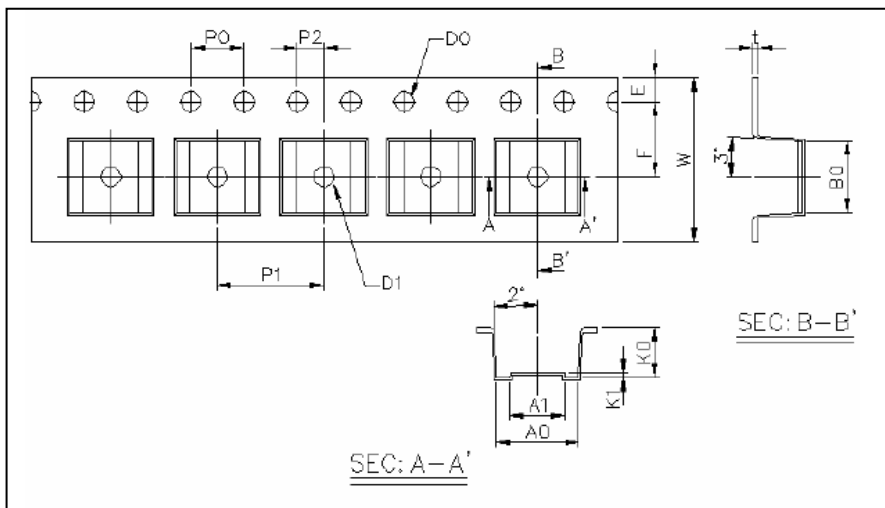

Dimension No.	A0	A1	B0	D0	D1	E	F
Dimension(mm)	6.2±0.1	4.1±0.1	7.4±0.1	1.5±0.1	1.5±0.1	1.75±0.1	5.5±0.1
Dimension No.	P0	P1	P2	t	W	K0	K1
Dimension (mm)	4.0±0.1	8.0±0.1	2.0±0.1	0.4±0.1	12.0 +0.3 / -0.1	3.7±0.1	0.3±0.1



ISOCOM
COM-

ICPLM600, ICPLM601

NOTES :

- Isocom is continually improving the quality, reliability, function or design and Isocom reserves the right to make changes without further notices.
- The products shown in this publication are designed for the general use in electronic applications such as office automation equipment, communications devices, audio/visual equipment, electrical application and instrumentation.
- For equipment/application where high reliability or safety is required, such as space applications, nuclear power control equipment, medical equipment, etc., please contact our sales representatives.
- When requiring a device for any "specific" application, please contact our sales for advice.
- The contents described herein are subject to change without prior notice.
- Do not immerse device body in solder paste.



ISOCOM

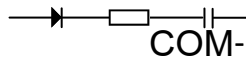

COM-

DISCLAIMER

ISOCOM is continually working to improve the quality and reliability of its products. Nevertheless, semiconductor devices in general can malfunction or fail due to their inherent electrical sensitivity and vulnerability to physical stress. It is the responsibility of the buyer, when utilizing ISOCOM products, to comply with the standards of safety in making a safe design for the entire system, and to avoid situations in which a malfunction or failure of such ISOCOM products could cause loss of human life, bodily injury or damage to property.

In developing your designs, please ensure that ISOCOM products are used within specified operating ranges as set forth in the most recent ISOCOM products specifications.

__ The ISOCOM products listed in this document are intended for usage in general electronics applications (computer, personal equipment, office equipment, measuring equipment, industrial robotics, domestic appliances, etc.). These ISOCOM products are neither intended nor warranted for usage in equipment that requires extraordinarily high quality and/or reliability or a malfunction or failure of which may cause loss of human life or bodily injury ("Unintended Usage"). Unintended Usage include atomic energy control instruments, airplane or spaceship instruments, transportation Instruments, traffic signal instruments, combustion control instruments, medical Instruments, all types of safety devices, etc.. Unintended Usage of ISOCOM products listed in this document shall be made at the customer's own risk.

__ Gallium arsenide (GaAs) is a substance used in the products described in this document. GaAs dust and fumes are toxic. Do not break, cut or pulverize the product, or use chemicals to dissolve them. When disposing of the products, follow the appropriate regulations. Do not dispose of the products with other industrial waste or with domestic garbage.

__ The products described in this document are subject to the foreign exchange and foreign trade laws.

__ The information contained herein is presented only as a guide for the applications of our products. No responsibility is assumed by ISOCOM Components for any infringements of intellectual property or other rights of the third parties which may result from its use. No license is granted by implication or otherwise under any intellectual property or other rights of ISOCOM Components or others.

__ The information contained herein is subject to change without notice.