

1 | 2 | 3 | 4

A

B

C

D

A

B

C

D

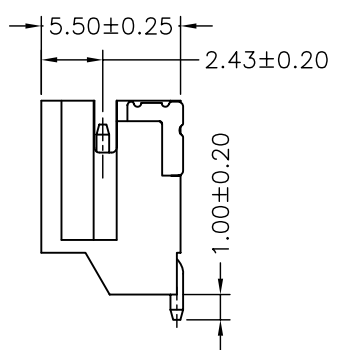
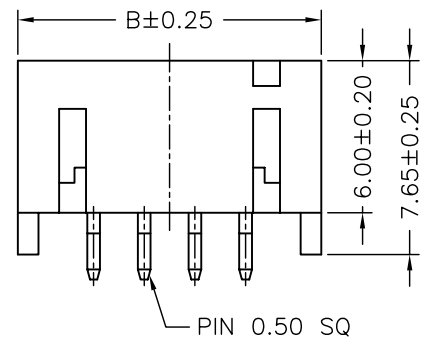
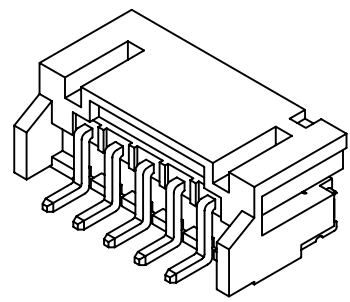
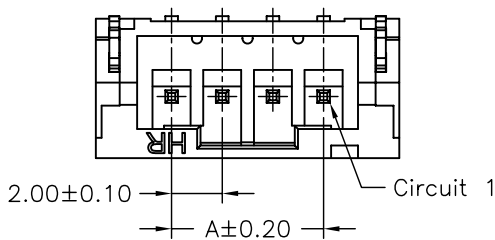

Ordering code



A2001 WR-S-XP D01				
①	②	③	④	⑤
① Series No.	② Connector type: WR=Right angle			
③ Mounting type: S=SMT without boss				
④ No. of circuits				
⑤ Option code: D01=Gold-flash				

SPECIFICATIONS

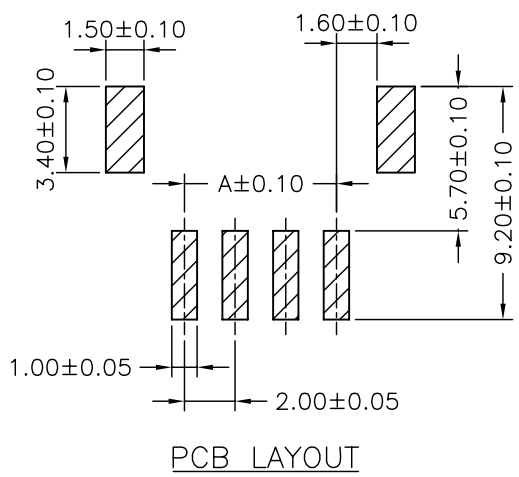
Current Rating: 2A AC,DC
 Voltage Rating: 100V AC,DC
 Temperature Range: -25°C ~ +85°C
 Contact Resistance: 10mΩ Max.
 Insulation Resistance: 1000MΩ Min.
 Withstanding Voltage: 800V AC/minute
 Pin Material: Brass
 Solder Tabs: Brass
 Material: Nylon 6T,UL94V-0
 Color: Natural(Beige)



Circuit No.	Dimensions	
	A	B
02P	2.00	8.00
03P	4.00	10.00
04P	6.00	12.00
05P	8.00	14.00
06P	10.00	16.00
07P	12.00	18.00
08P	14.00	20.00
09P	16.00	22.00
10P	18.00	24.00
11P	20.00	26.00
12P	22.00	28.00
13P	24.00	30.00
14P	26.00	32.00
15P	28.00	34.00
16P	30.00	36.00

 燦達電子工業股份有限公司 JOINT TECH ELECTRONIC IND. CO., LTD.							
UNIT	SCALE	SHEET	TITLE:				
mm		1 of 2					
DRAWN BY	APPROVED BY		2.00mm PITCH 90° WAFER-SMT TYPE				
李勤	董正一						
2006.07.21	2006.07.21						
GENERAL TOLERANCE							
A2	EN1310310376	2013.10.31	郭木思	DRAW NO. : A2001WR-S-XP01			
A1	REVISE	2013.02.26	2006.09.02			X. X±0.25	ANGLE±
A0	NEW RELEASE	2006.07.21	李勤			X. XX±0.15	
REV.	DESCRIPTION	DATE	NAME			X. XXX±0.05	

1 | 2 | 3 | 4