

## ◆ Product Description

The GH1120 is a Hall-effect latch designed in CMOS technology. The IC internally includes a voltage regulator, Hall sensor with dynamic offset cancellation system, Schmitt trigger and an open-drain output driver. With no magnetic field present, the output is in the “on” state(Low). While the magnetic flux density(B) is larger than operate point(Bop),the output will be turned off(High) and the output is latched “off” state until the magnetic flux density (B) is lower than release point(Brp),then turn on(Low). It has wide operating voltage range and extended choice of temperature range, it is quite suitable for use in automotive, industrial and consumer applications.

## ◆ Features

- 3.5V to 24V DC Operation Voltage
- CMOS Technology
- Chopper-stabilized amplifier stage
- 25mA Output Sink Current
- Operating Temperature: -40~ +125°C
- High Magnetic Sensitivity: B<sub>hys</sub>=60Gauss(Typ.)
- Lead Free Package: SIP-3L and SC59  
(Commonly known as TO-92S and SOT-23-3L in Asia)
- Lead Free Finish/RoHS Compliant

## ◆ Application

- Rotor Position Sensing
- Current Switch
- Encoder
- RPM Detection

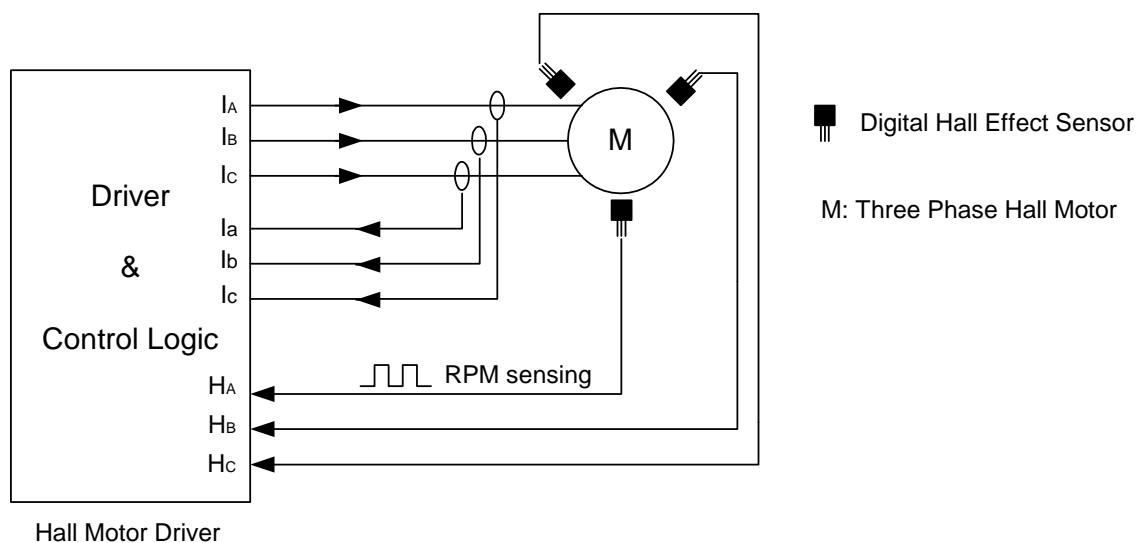

Fig.1 Functional Application Circuit in 3-Phase Hall Motor

## ◆ Pin Description

Table 1-1 Pin definition and description for SIP-3L(TO-92S)

PIN #	NAME	P/I/O	FUNCTION DESCRIPTION
1	VDD	P	Input Power Supply
2	GND	P	Ground
3	OUT	O	Output Stage of Open Drain

Table 1-2 Pin definition and description for SC59(SOT-23-3L)

PIN #	NAME	P/I/O	FUNCTION DESCRIPTION
1	VDD	P	Input Power Supply
2	OUT	O	Output Stage of Open Drain
3	GND	P	Ground

## ◆ Pin Configuration

(Top View)

SIP-3L(TO-92S)

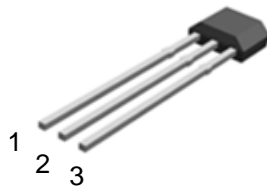

SC59(SOT-23-3L)

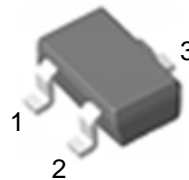

◆ **Absolute Maximum Rating** (Note 1)

SYMBOL	PARAMETER	RATING
VDD	Supply Voltage	+28VDC
Vout (off)	Voltage externally applied to output	+28VDC max, OFF condition only -0.5 V min., OFF or ON condition
Io (sink)	Output "ON" Current	50 mA
PD	Power Dissipation	450mW(SIP-3L);230mW(SC59)
Top	Operation Temperature Range	-40 to +125 °C
Tst	Storage Temperature Range	-65 to +150 °C
B	Magnetic Flux	No limit.

**Note 1:** Absolute Maximum Ratings are those values beyond which the life of a device may be impaired.

◆ **Electrical Characteristics** (TA = 25°C)

SYMBOL	PARAMETER	CONDITIONS	MIN	TYP	MAX	UNIT
VDD	Supply Voltage	Operating	3.5		24	V
VO(SAT)	Output Saturation Voltage	VDD = 12V, OUT "ON", Io = 10mA			300	mV
		VDD = 12V, OUT "ON", Io = 20mA			500	mV
IDD	Supply Current	VDD =3.5~24V, OUT "OFF"		2.0	5.0	mA
ILE	Output Leakage Current (Leakage into sensor output)	Released			10	μA
Tr	Output Switching Time	Rise Time	RL=820Ω, CL=20pF		0.45	μS
		Fall Time	RL=820Ω, CL=20pF		0.45	μS
F <sub>SW</sub>	Maximum Switching Frequency			10		KHz

◆ **Magnetic Characteristics** (TA = 25°C, VDD=12V)

SYMBOL	PARAMETER	MIN.	TYP.	MAX.	UNIT
Bop	Operation Point	5	30	80	Gauss
Brp	Release Point	-80	-30	-5	Gauss
Bhy	Hysteresis	30	60	90	Gauss

◆ Functional Block Diagram

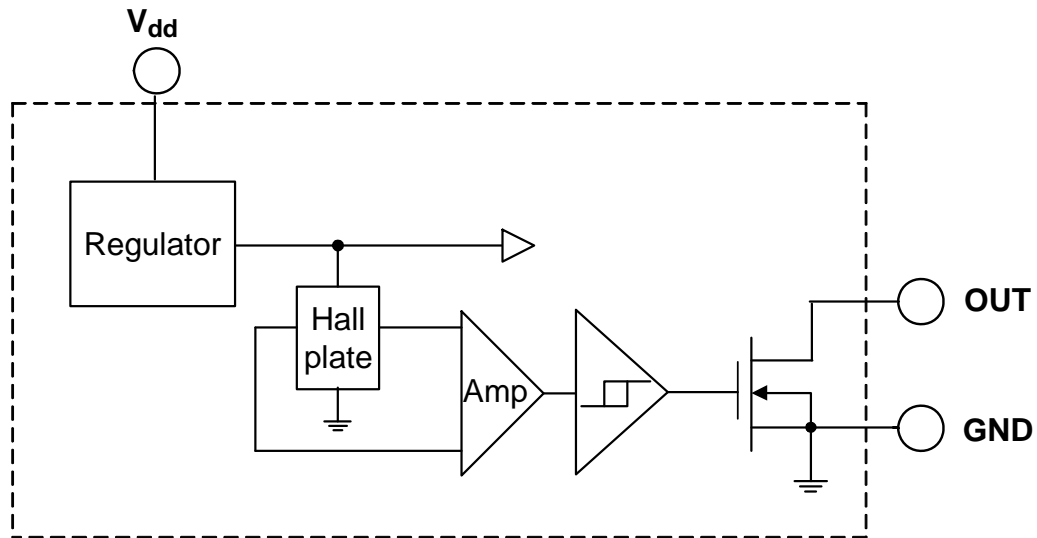

Figure 1. Function Block Diagram of GH1120

◆ Operating Characteristics

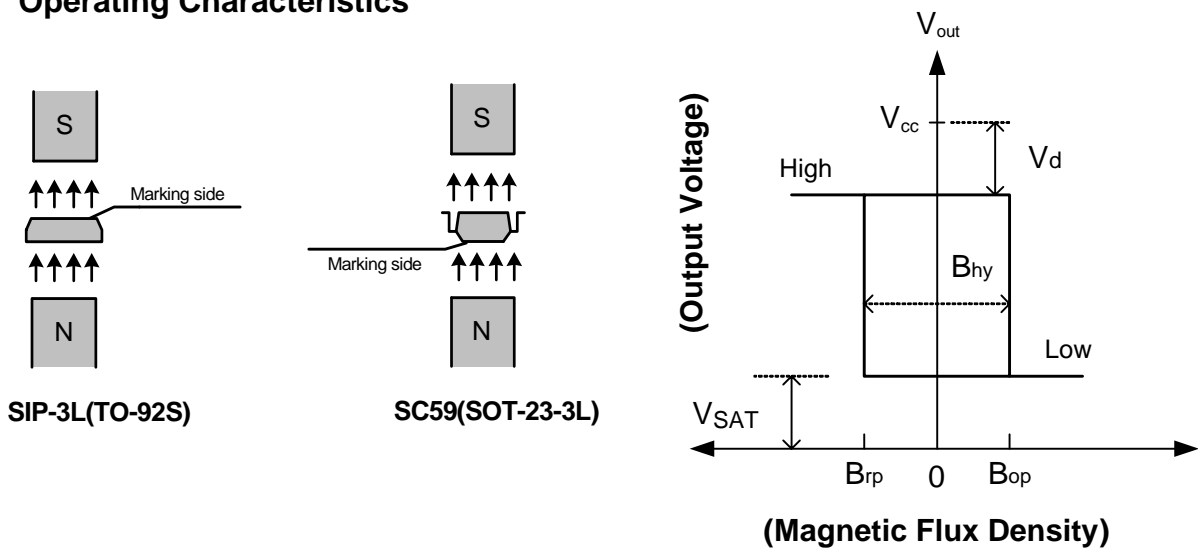

Figure 2. Operating Characteristics of GH1120

Table 2: Switching Function

Parameter	Pole	OUT	Pole	OUT
	(SC59/SOT-23-3L)		(SIP-3L/TO-92S)	
South Pole	$B < B_{RP}$	High	$B > B_{OP}$	Low
North Pole	$B > B_{OP}$	Low	$B < B_{RP}$	High

◆ Typical Characteristics

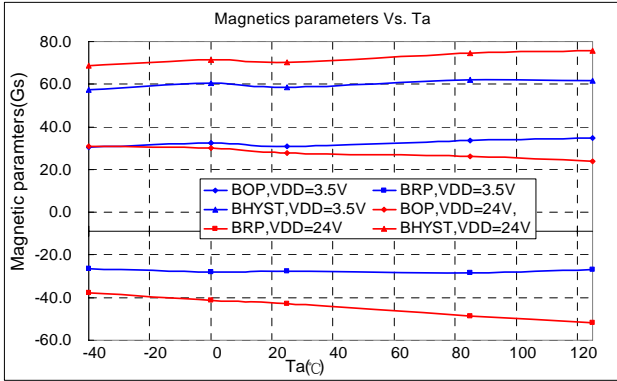

Figure 3-1. Magnetic parameters Vs. Ta

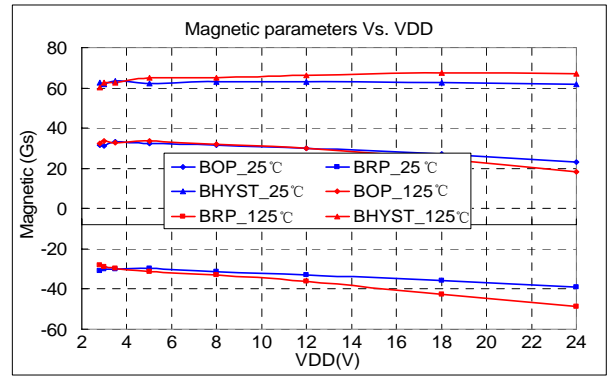

Figure 3-2. Magnetic parameters Vs. VDD

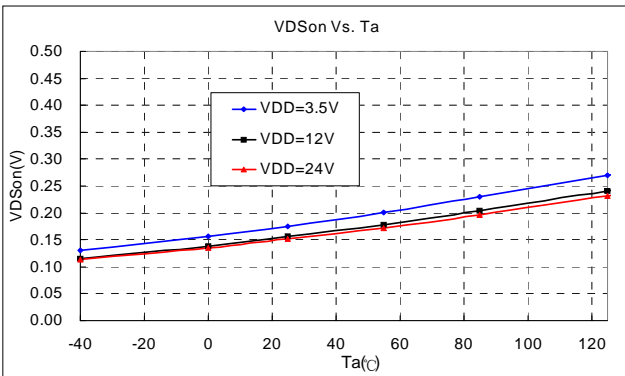

Figure 3-3. VDSon Vs. Ta

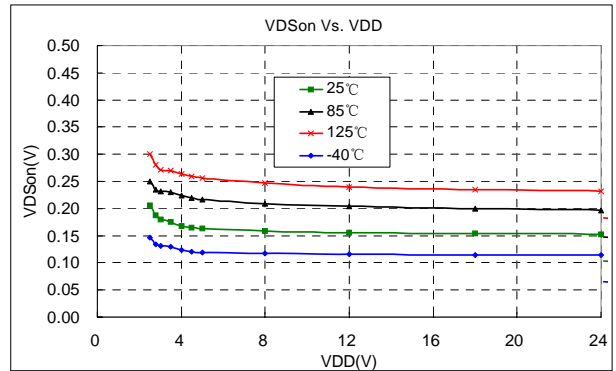

Figure 3-4. VDSon Vs. VDD

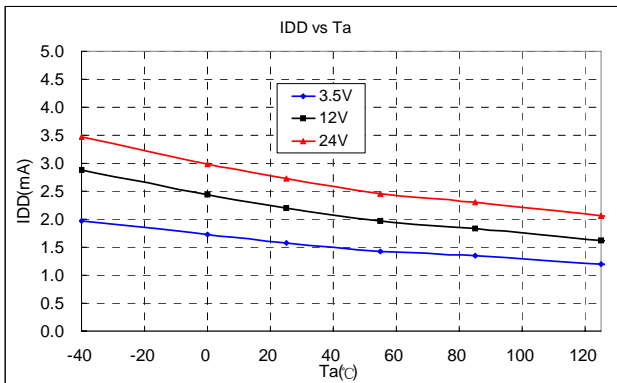

Figure 3-5. IDD Vs. Ta

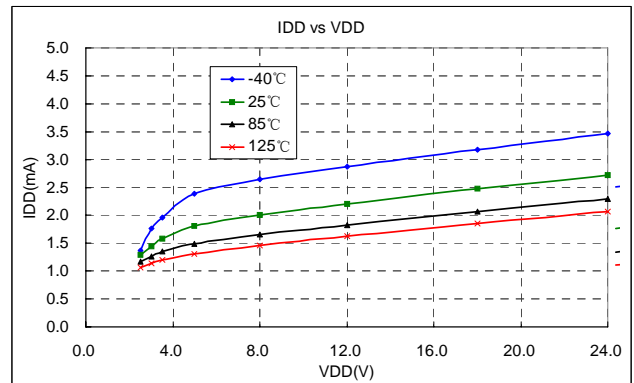

Figure 3-6. IDD Vs. VDD

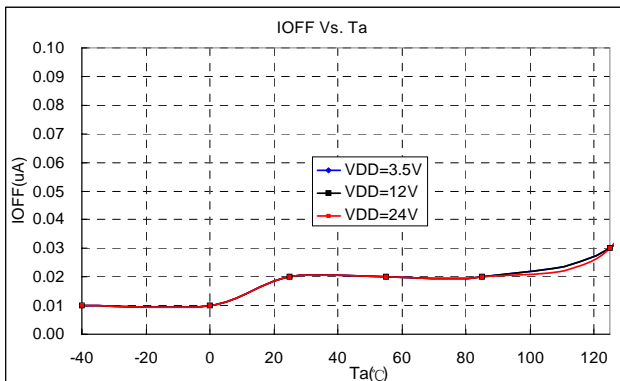

Figure 3-7. IOFF Vs. Ta

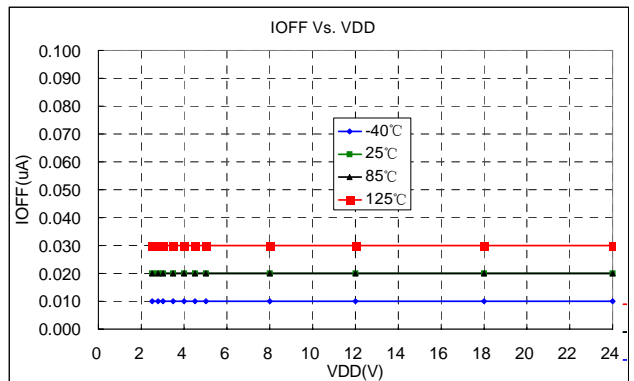
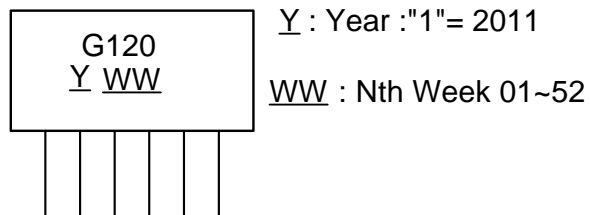

Figure 3-8. IOFF Vs. VDD

◆ Marking Information

(1) SIP-3L(TO-92S)

( Top View )



(2) SC59 (SOT-23-3L)

( Top View )

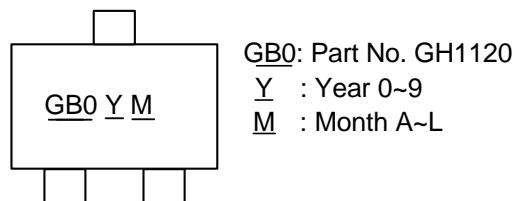

◆ **Package Information** (unit: mm)

**(1) Package Type: SIP-3L(TO-92S) for Bulk only**

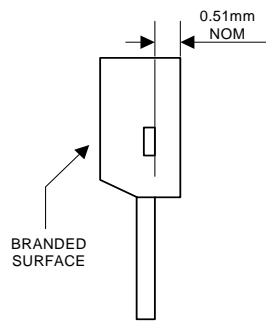

Active Area Depth

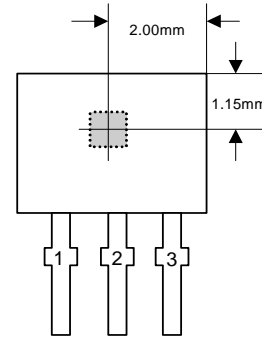

Sensor Location

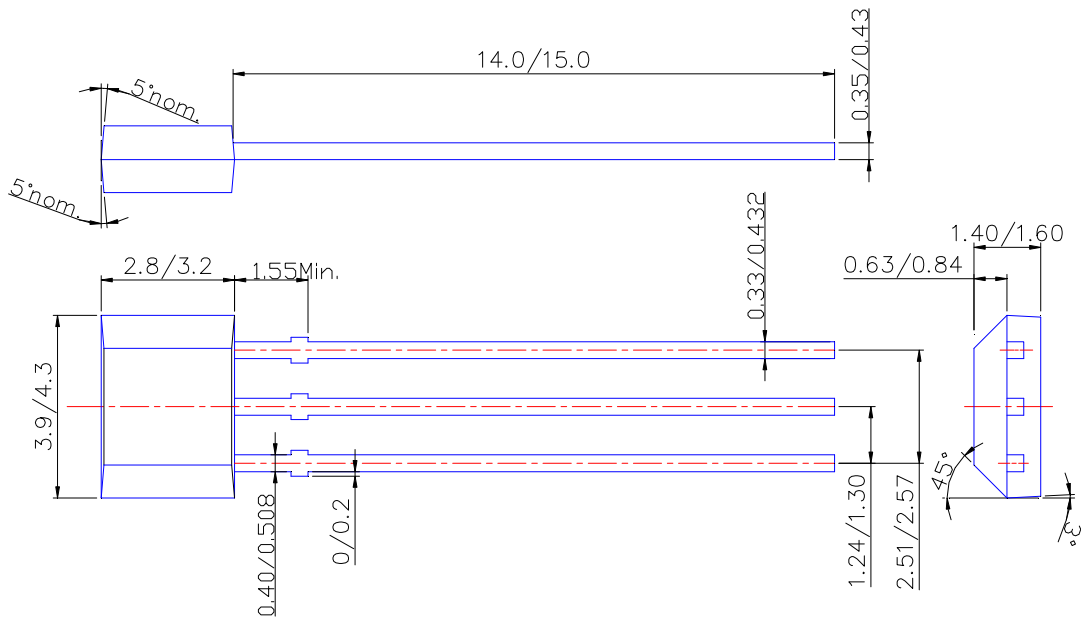

**(2) SC59 (SOT-23-3L)**

