



# 瓷介电容器

# Ceramic Capacitors

## □用途 (Application)

该产品主要用于彩电、计算机显示器、复印机、节能灯等的电源电路，行输出电路等部分。

Using for H-out and supply circuits of colour TV and monitor, copy machine, inverter lighting .

## □产品电压、材质、尺寸对照表(Product voltage, material, size reference table)

产品及尺寸代码 Product and size code	额定直流电压 Rated DC voltage	温度特性 Temperature Characteristic					尺寸 size			
		2B4	2E4	2F4	2R4	HR	Dmax (mm)	Tmax (mm)	F (mm)	d (mm)
		标称电容量 Rated Capacitance								
CT81-06	1KV	101~122	222	222	101~681	101~681	6.5	4.0	5.0/7.5/10	0.56
CT81-08		152~182	332~472	472	821~152	821~152	8.5	4.0	5.0/7.5/10	0.56
CT81-10		222	682	103	182~222	182~222	10.0	4.0	5.0/7.5/10	0.56
CT81-12		272~472	103	203~223	332~392	332~392	12.5	4.0	5.0/7.5/10	0.56
CT81-14		562~682			472	472	14.5	4.0	5.0/7.5/10	0.56
CT81-16		103					16.0	4.0	7.5/10	0.56
CT81-18				473~503			18.0	4.0	7.5/10	0.56
CT81-06	2KV	101~471	102		101~331	101~331	6.5	5.0	5.0/7.5/10	0.56
CT81-08		561~102	152	332~472	391~681	391~681	8.5	5.0	5.0/7.5/10	0.56
CT81-09		122~152	222~332		821~122	821~122	9.5	5.0	5.0/7.5/10	0.56
CT81-10		182			152	152	10	5.0	5.0/7.5/10	0.56
CT81-11		222	472	103	182	182	11.0	5.0	7.5/10	0.56
CT81-12		272~332	682		222	222	12.5	5.0	7.5/10	0.56
CT81-14		392					14.5	5.0	7.5/10	0.56
CT81-16		472	103		332	332	16.0	5.0	7.5/10	0.56
CT81-18				203~223			18.0	5.0	10	0.56
CT81-22				473			22.0	5.0	10	0.56

## □标识方法 (Marking)

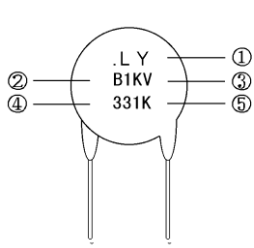
	① 公司代号 Manufacturer's Code
	② 温度特性 Temperature Characteristic
	③ 额定电压 Rated Voltage
	④ 标称容量 Rated Capacitance
	⑤ 容量偏差 Tolerance of Capacitance

# □引线形式 Lead Shape

散件 (bulk): (单位: mm)

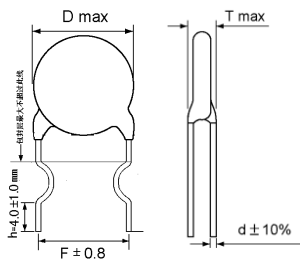

a 式  
Type a

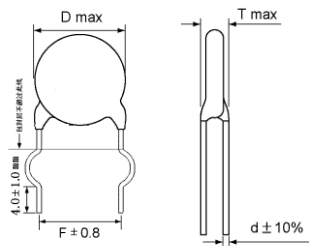

A 式  
Type A

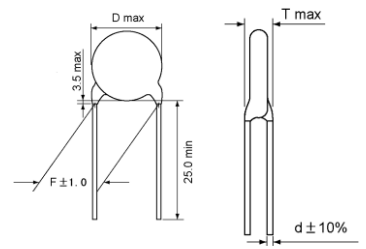

b 式  
Type b

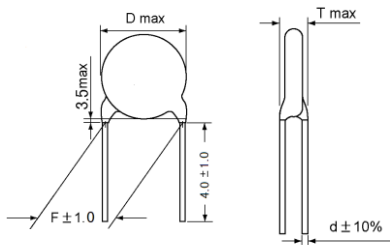

d 式  
Type d

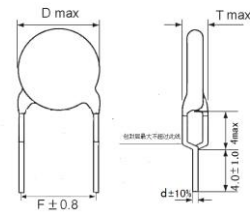

e 式  
Type e

注: 引线长度根据客户要求 (Note: lead length according to customer requirements )

编带(Taping Package):

●A 式 引线间距  $F=5.0\text{mm}$   
Type A (lead spacing  $F=5.0\text{mm}$ )

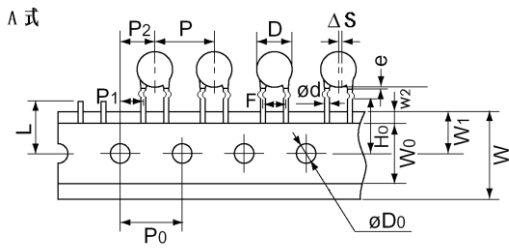
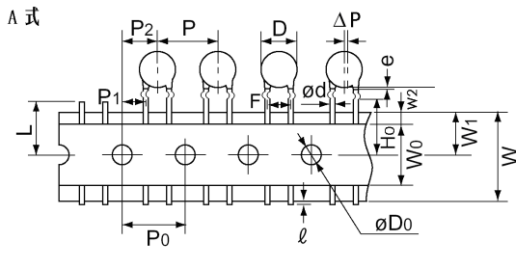

●a 式 引线间距  $F=5.0\text{mm}$   
Type a (lead spacing  $F=5.0\text{mm}$ )

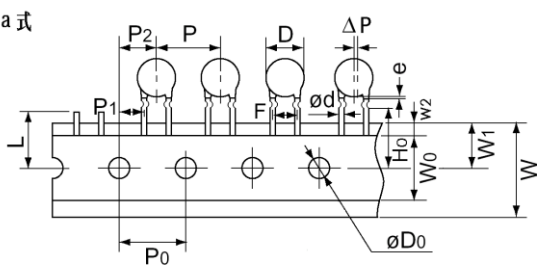
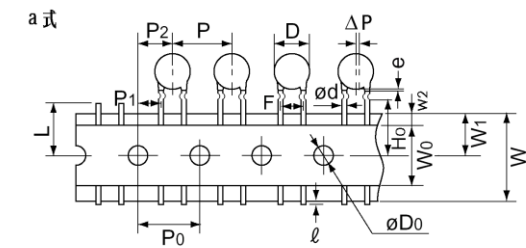

●A 式 引线间距  $F=7.5\text{mm}$   
Type A (lead spacing  $F=7.5\text{mm}$ )

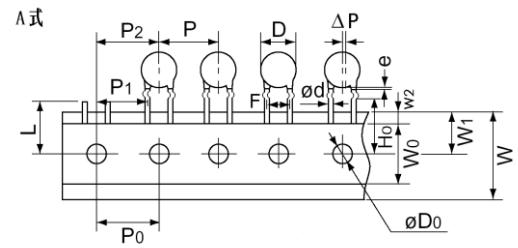
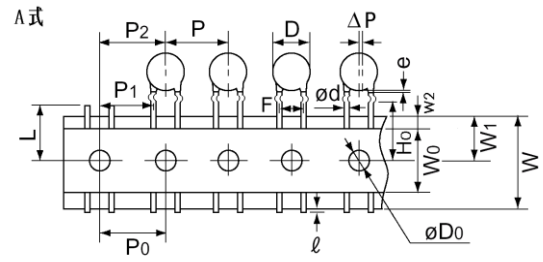

●a 式 引线间距  $F=7.5\text{mm}$   
Type a (lead spacing  $F=7.5\text{mm}$ )

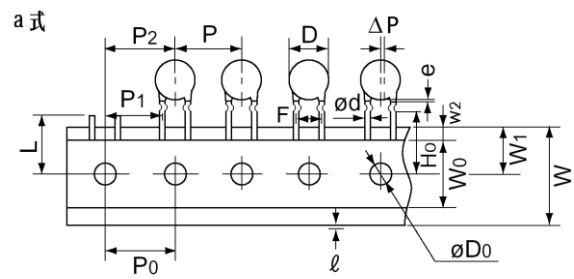
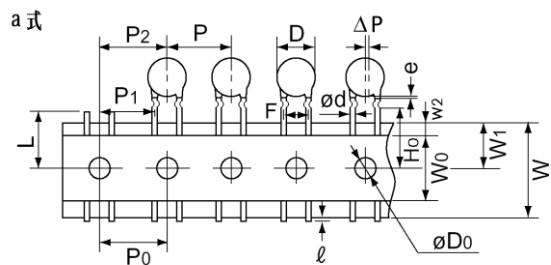

● b 式 引线间距  $F=5.0\text{mm}$

Type b (lead spacing  $F=5.0\text{mm}$ )

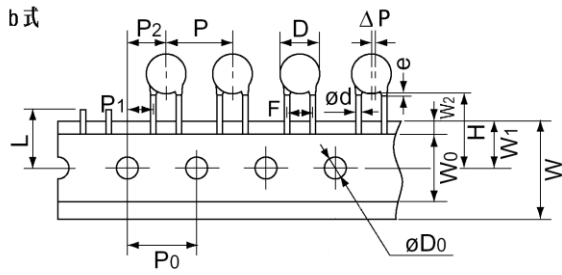
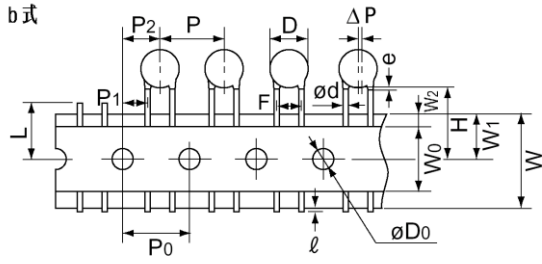

● b 式 引线间距  $F=7.5\text{mm}$

Type b (lead spacing  $F=7.5\text{mm}$ )

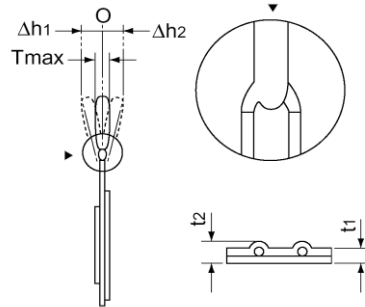
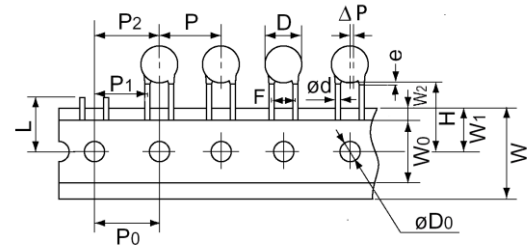
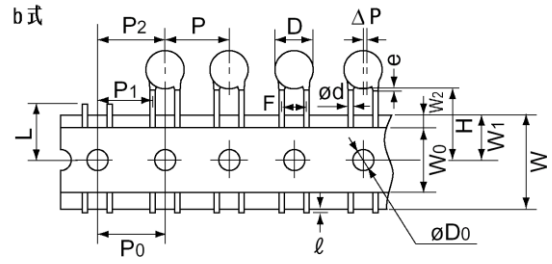

代码 Code	A、a 式 Type A、a		b 式 Type b	
F	$5.0 \pm 0.6$	$7.5 \pm 1.0$	$5.0 \pm 0.6$	$7.5 \pm 1.0$
P	$12.7 \pm 0.5$	$12.7 \pm 0.5$	$12.7 \pm 0.5$	$12.7 \pm 0.5$
P0	$12.7 \pm 0.3$	$12.7 \pm 0.3$	$12.7 \pm 0.3$	$12.7 \pm 0.3$
P1	$3.85 \pm 0.7$	$8.95 \pm 1.0$	$3.85 \pm 0.7$	$8.95 \pm 1.0$
P2	$6.35 \pm 1.3$	$12.7 \pm 1.3$	$6.35 \pm 1.3$	$12.7 \pm 1.3$
$\Delta h$	2.0max			
W	$18.0 \pm 0.5$			
W0	6.0min			
W1	$9.0 \pm 0.5$			
W2	$1.5 \pm 1.5$			
H			$20 \pm 2$	
H0	$16.0 - 0.5 / +1.0$		---	
D0	$4.0 \pm 0.2$			
$\Phi d$	$0.56 \pm 0.056$			
L	11.0 max			
e	不过弯中央 No over the center of crim		3.5max	
t1	$0.6 \pm 0.3$			
t2	1.5max			
$\Delta P$	$0 \pm 2.0$			
$\ell$	1.0max			

## □结构(Structure)

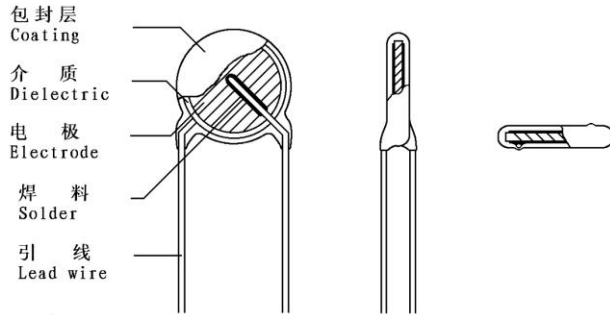

包封层(Coating) : 环氧树脂(Epoxy Resin)

介质(Dielectric): 陶瓷 (Ceramic)

电极(Electrode) : 银 (Silver)

焊料(Solder) : 锡(Alloy Tin)

引线(Lead Wire) : 镀锡引出线(Lead)

## □主要材料(Main Material)

$SrCO_3$   $BaCO_3$   $TiO_2$   $Bi_2O_3$   $CaCO_3$   $Nb_2O_5$   $MgO$

银膏(Silver paste) 环氧树脂(Epoxy Resin)

## □室内条件(Room Condition)

温度(Temp.):  $15\sim 35^\circ C$  湿度(R. H.): 45~75%

气压(Atm pressure):  $86\sim 106kPa$  (860~1060mbar)

## □测试条件(Test Condition)

温度(Temp.):  $20 \pm 2^\circ C$  湿度(R. H.): 50~60%

电压(Vol.):  $1.0 \pm 0.2V_{rms}$  频率(Freq.):  $1 \pm 0.2KHz$

## □容量 温度变化曲线 -Temp. Curve

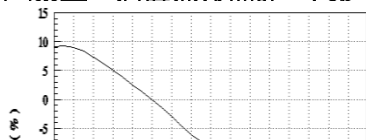

2R4 组

HR 组

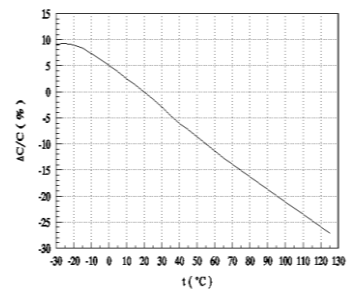
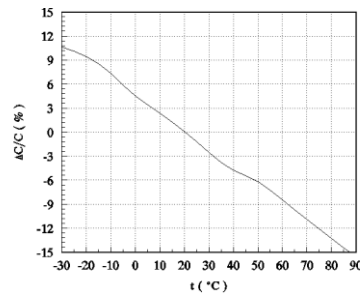
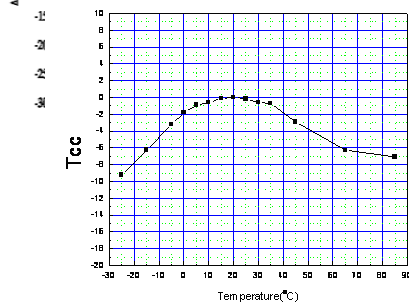

2E4 组

2F4 组

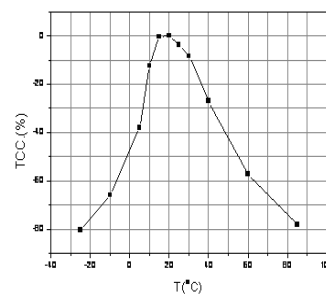
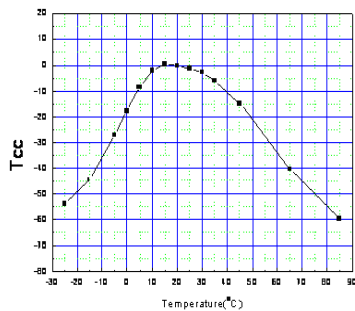

□型号命名方法 Part Code Designation

CT81 — 1KV — 06a — 2B4 — 331 K - T

①                      ②                      ③ ④                      ⑤                      ⑥                      ⑦                      ⑧

①种类 Class

代码 Code	种类 Class
CT81	II类高压 Class II High-Voltage

⑤温度特性 Temperature Characteristic

代码 Code	容量变化 Cap. Change
2B4	-10~+10%
2R4	-15~+15%
HR	-30~+15%
2E4	-56~+22%
2F4	-80~+30%

②额定电压 Rated Voltage

代码 Code	额定电压 Rated Vol.	代码 Code	额定电压 Rated Vol.
1KV	1000V. DC		
2KV	2000V. DC		

⑥标称容量 Rated Capacitance

代码 Code	静电容量 Capacitance	代码 Code	静电容量 Capacitance
101	100pF	152	1500pF
151	150pF	182	1800pF
221	220pF	222	2200pF
331	330pF	103	10000pF
102	1000pF	203	20000pF

③主体外径 Body Diameter

代码 Code	最大外径 Max Diameter of Body	代码 Code	最大外径 Max Diameter of Body
06	6.5mm	12	12.5mm
08	8.5mm	14	14.5mm
09	9.5mm	16	16.0mm
10	10.0mm	18	18.0mm
11	11.0mm	22	22.0mm

⑦容量允差 Tolerance

代码 Code	容量允差 Tolerance
K	± 10%
M	± 20%
Z	-20~+80%

④引线形式 Lead Shape

代码 Code	形式 Shape
a	单内弯 Single inside Crimp
A	单外弯 Single outside Crimp
b	直脚 Straight long
d	短直脚 Straight Short
e	前后弯 Vertical crimp

⑧包装方式 package Shape

代 码 Code	形式 Shape
T	编带 Taping Package
无标识 No Mark	散件 bulk





**□包装 (packing)**

散件包装 (bulk packing)

1、包装数量 (packing quantity):

成型方式 Molding mode	袋装数量(支) Quantity per bag (PCS)	备注 Remark
A、a、d、b、e	1000 ± 1/500 ± 1	塑料袋尺寸: Size of plastic bag 1#: 275×200mm 2#: 215×160mm

2、包装标识 (packing marking):

示例(Example)	项 目 ( Item )	
		公司商标 (Manufacturer's Marking)
	物料编码 Code	客户要求时 When the customer require
	规格型号 Model	详见如上表格, (Please see the detail in the upper sheet)
	生产批号 Product lots	生产批号 Product lots
	生产日期 Productive date	产品生产时间 the produce time of the product
	数 量 Quantity	每袋的包装数量 the packing quantity per plastic bag

3、外包装 (over-wrap packing):

内包装箱 (internal packing boxes) (A1:360×200×140mm、A2:198×177×138mm)

外包装箱 (over-wrap boxes) (B1:460×380×220mm、B2:425×380×170mm)



装箱数量应为 100、500 的整数倍。(The packing quantity should be integral multiple of one-hundred or five-hundred. )

编带包装 (Taping Package packing)

1、包装数量 (packing quantity):

引线间距 Lead spacing	包装盒分类 Kinds of plastic box	成型方式 Molding mode	包装数量 Quantity per bag	备注 Remark
F=5.0mm	1# 2#	A、a、b	2000	包装盒尺寸: Size of plastic box 1 <sup>#</sup> : 336×240×45mm 2 <sup>#</sup> : 336×290×48mm
F=7.5mm	1# 2#	A、a、b	1000~2000	

3、包装标识 (packing marking):

示例 (Example)	项 目 (Item)	
		公司商标 (Manufacturer's Marking)
	物料编码 Code	用户要求时 When the customer require
	规格型号 Model	详见如上表格, (Please see the detail in the upper sheet)
	生产批号 Product lots	生产批号 Product lots
	生产日期 Productive date	产品生产时间 the produce time of the product
	数 量 Quantity	每袋的包装数量 the packing quantity per plastic bag

3、外包装 (over-wrap packing):

内包装箱 (internal packing boxes) (A1:360×200×140mm、A2:198×177×138mm)

外包装箱 (over-wrap boxes) (B1:460×380×220mm、B2:425×380×170mm)

装箱数量应为 1000、2000 的整数倍。(The packing quantity should be integral multiple of 1000 or 2000. )

□规格及试验方法 Specification and Test Method

项 目 ITEM		规 格 SPECIFICATION	试 验 方 法 及 条 件 TEST METHOD AND CONDITION				
1. 存储温度范围 Storage Temp. Range		B、R、E、F: -25℃~+ 85℃ HR: -25℃~+125℃					
2. 使用温度范围 Operating Temp. Range		B、R、E、F: -25℃~+ 85℃ HR: -25℃~+125℃					
3. 外观尺寸 Appearance and Dimension		外观无可见损伤 尺寸在规格内 Appearance has no marked defect. Dimensions shall be within specified tolerance.	外观用目视法观测 尺寸用游标卡尺测量 Appearance be watched on sight Dimension be measured by caliper				
4. 标识 Mark		应清晰可见 Should be discerned easily.	用目视法观测 Be watched on sight				
5. 静电容量 Capacitance		在规格范围内 Within specified tolerance	温度 Temp. 20±2℃ 电压 Vol. 1.0±0.2Vrms 频率 Freq. 1±0.1KHz				
6. 损耗因数 Dissipation Factor		B、E:2.5% max R、HR: :0.2% max F:3.5% max	同上 Same condition as capacitance				
7. 绝缘电阻 Insulation Resistance		大于 10,000MΩ 10,000MΩmin	500±50V. DC 的电压充电一分钟。 The insulation Resistance shall be measured with 500±50V. DC within 60±5 sec of charging.				
8. 耐电压 Dielectric Strength	端子间 Between Lead Wires	无不良 No failure.	端子间施加 200%的额定电压一分钟。(3KV≤UR <6.0KV: 1.5UR+500V; UR>6.0KV : 1.5UR ) (充放电电流<50mA) Apply a DC voltage of 200% of the rated voltage for 1 min. (3KV≤UR <6.0KV: 1.5UR+500V; UR>6.0KV : 1.5UR ) (Charge/discharge current<50mA )				
	端子与外壳间 Body Insulation	无不良 No failure.	如图, 将电容器的引线连在一起, 主体外紧包一层金属箔, 边沿距引线 3-4mm, 在电容器引线和金属箔间施加 200%的额定电压一分钟。(3KV≤UR <6.0KV: 1.5UR+500V; UR>6.0KV : 1.5UR ) (充放电电流<50mA) The terminals of the capacitor shall be connected together, A metal foil shall be closely wrapped around the body of the capacitor to the distance of about 3-4 mm from each terminal, A voltage of 200% of the rated is applied between the capacitor lead wires and the metal balls for 1 min. (3KV≤UR <6.0KV: 1.5UR+500V; UR>6.0KV : 1.5UR ) (Charge/discharge current<50mA )				
9. 温度特性 Temp. Char.	Ct-C3 C3	B:-10~+10% R:-15~+15% HR:-30~+15% E:-56~+22% F:-80~+30%	静电容量测试须依下列顺序测试。 试验前: 电容器应放置在 85±2℃ (HR:125±2℃) 的温度下 1 小时, 然后在常温下恢复 24±2 小时后测试。 The capacitance measurement shall be made at each step specified as following. Capacitance change from the volume of step 1 shall not exceed the limit specified. pre-treatment: The capacitor shall be placed at 85±2℃ (HR:125±2℃) for 1 hour, then placed at room condition for 24±2 hours before initial measurement.				
			步骤(Step)	①	②	③	④
		温度(Temp.)	20±2℃	-25±2℃	20±2℃	85±2℃ (HR:125±2℃)	20±2℃

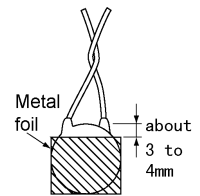

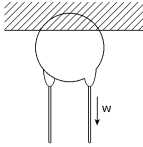
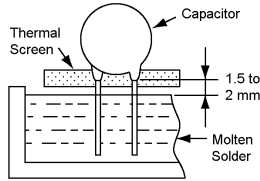
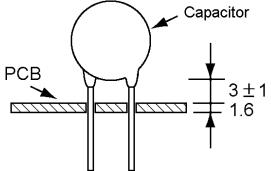
项 目 ITEM	规 格 SPECIFICATION		试 验 方 法 及 条 件 TEST METHOD AND CONDITION																
10. 端子强度 Strength of Lead Wires (c 式不做此 项 Type c none)	抗拉强度 Pull	导线不断裂 电容器不破损 Lead wire shall not cut off and capacitor shall not be damaged	把制品固定, 在端子引出方向施加负荷 10N 保持 10±1 秒。 Fix the body of the capacitor and apply a tensile weight gradually to each lead wire in the radial direction of capacitor up to 10N, and keep it for 10±1sec. 																
	弯曲强度 Bending		在端子间施加 5N 负荷并弯曲 90°, 回复原后反向弯曲 90°, 每次弯曲时间为 2 至 3 秒, 连续 2 次。 Each lead wire shall be subjected to 5N weight and then a 90° bend, at the point of egress, in one direction return to original position, and then a 90° bend in the opposite direction at the rate of one bend in 2-3 s for 2times.																
11. 耐焊接热 Soldering Effect	外观 Appearance	无显著异常 No marked defect	将端子浸入温度为 260±5℃ 的熔锡内, 外保留 1.5-2.0mm 距离主体边缘, 并保持 5.0±0.5 秒。 试验前: 电容器应放置在 85±2℃ (HR:125±2℃) 的温度下 1 小时, 然后在常温下恢复 24±2 小时后测试。 试验后: 室内条件下恢复 24±2 小时。																
	容量变化 Capacitance Change	B: ±10% max R: ±15% max HR: -30~+15%max E、F: ±20% max	The lead wires shall be immersed into the melted solder of 260±5℃ up to about 1.5 to 2.0 mm from the main body for 5.0±0.5 sec. Pre-treatment: The capacitor shall be placed at 85±2℃ (HR:125±2℃) for 1 hour, then placed at room condition for 24±2 hours before initial measurement. Post-treatment: Capacitor shall be stored for 24±2 hours at room condition. 																
12. 温度循环 Temp. Cycling	外观 Appearance	无显著异常 No marked defect	将电容器放入高低温箱, 按下列步骤循环 5 次。 试验前: 电容器应放置在 85±2℃ (HR:125±2℃) 的温度下 1 小时, 然后在常温下恢复 24±2 小时后测试。 试验后: 在室内条件下恢复 24±2 小时测试。																
	容量变化 Capacitance Change	B: ±10% max R: ±15% max HR: -30~+15%max E、F: ±20% max	The capacitor shall be introduced into the test chamber, and shall be exposed to the temperature conditions as shown in table at 5 cycles. pre-treatment: The capacitor shall be placed at 85±2℃ (HR:125±2℃) for 1 hour, then placed at room condition for 24±2 hours before initial measurement. Post-treatment: Capacitor shall be stored for 24±2 hours at room conditions.																
<table border="1"> <thead> <tr> <th>步骤 (STEP)</th> <th>1</th> <th>2</th> <th>3</th> <th>4</th> </tr> </thead> <tbody> <tr> <td>温度 (TEMP.)</td> <td>-25±3℃</td> <td>20±2℃</td> <td>85±3℃ HR:125±3℃</td> <td>20±2℃</td> </tr> <tr> <td>时间 (TIME)</td> <td>30±3min.</td> <td>3min. max</td> <td>30±3min.</td> <td>3min. max</td> </tr> </tbody> </table>					步骤 (STEP)	1	2	3	4	温度 (TEMP.)	-25±3℃	20±2℃	85±3℃ HR:125±3℃	20±2℃	时间 (TIME)	30±3min.	3min. max	30±3min.	3min. max
步骤 (STEP)	1	2	3	4															
温度 (TEMP.)	-25±3℃	20±2℃	85±3℃ HR:125±3℃	20±2℃															
时间 (TIME)	30±3min.	3min. max	30±3min.	3min. max															
13. 耐振性 Vibration Resistance	外观 Appearance	无显著异常 No marked defect	电容器须焊锡固定好, 固定点距电容器主体 3±1.0mm, 并经 10Hz→500Hz 之振动频率, 全振幅 1.5mm, 振动时间为 6 小时, 往 X、Y、Z 轴三个方向 (各 2 小时)。 试验前: 电容器应放置在 85±2℃ (HR:125±2℃) 的温度下 1 小时, 然后在常温下恢复 24±2 小时后测试。 试验后: 在室内条件下恢复 24±2 小时测试。																
	容量变化 Capacitance Change	B: ±10% max R: ±15% max HR: -30~+15%max E、F: ±20% max	The capacitor shall firmly be soldered to the supporting lead wires about 3±1.0 mm from the body of the capacitor and vibration which is 10 to 500Hz in the vibration frequency range, 1.5mm in total amplitude, for a total of 6 hours, 2 hours each in three mutually perpendicular directions. pre-treatment: The capacitor shall be placed at 85±2℃ (HR:125±2℃) for 1 hour, then placed at room condition for 24±2 hours before initial measurement. Post-treatment: Capacitor shall be stored for 24±2 hours at room conditions. 																

项目 ITEM	规格 SPECIFICATION		试验方法及条件 TEST METHOD AND CONDITION
14. 易焊性 Solder ability of lead wires	导线上沾锡面积大于 90%。 Lead wire shall be soldered with uniformly coated on the axial direction over 90% of the circumferential direction.		导线须浸入助焊剂后再浸入 245±5℃的熔锡内，松香浓度 25wt，距离主体 2.0~2.5mm，时间 2±0.5 秒。 The lead wires of the capacitor shall be dipped into a alcohol solution of 25% wt rosin and then into molten solder of 245±5℃ for 2±0.5 sec. In both case the depth of dipping is up to about 2.0 to 2.5 mm from the root of the lead wires.
15. 碰撞试验 Collision Resistance	外观 Appearance	无显著异常 No marked defect	电容器须焊锡固定好，固定点距电容器主体 3±1.0mm，并施加一加速度为 390m/s <sup>2</sup> ，脉冲时间为 6ms 的碰撞，次数为 4000 次。 试验前：电容器应放置在 85±2℃ (HR:125±2℃) 的温度下 1 小时，然后在常温下恢复 24±2 小时后测试。 试验后：在室内条件下恢复 24±2 小时测试。 The capacitor shall firmly be soldered to the supporting lead wire about 3±1.0 mm from the body of the capacitor and a collision which is 390m/s <sup>2</sup> in the acceleration, 6ms in the pulse cycle for 4000 times. pre-treatment: The capacitor shall be placed at 85±2℃ (HR:125±2℃) for 1 hour, then placed at room condition for 24±2 hours before initial measurement. Post-treatment: Capacitor shall be stored for 24±2 hours at room conditions.
	容量变化 Capacitance Change	B: ±10% max R: ±15% max HR: -30~+15% max E、F: ±20% max	
16. 湿热循环 Humidity Cycling	外观 Appearance	无显著异常 No marked defect	电容器在温度 40±2℃，湿度 95±3%RH 下放置 8 小时，室温下放置 16 小时，循环 5 次。 试验后：在室内条件下恢复 1 至 2 小时。 Set the capacitor for 8 hours at 40±2℃ in 95±3% RH, then placed at room condition for 16 hours, circulating for 5 times. Post-treatment: The capacitor shall be stored for 1 to 2 hours at room condition.
	容量变化 Capacitance Change	B: ±10% max R: ±15% max HR: -30~+15% max E: ±20% max F: ±20% max	
	损耗因数 D. F.	B、E: 5.0% max R、HR: 0.4% max F: 7.0% max	
	绝缘电阻 I. R.	大于 2500MΩ 2500MΩmin	
17. 耐湿性 Humidity (Under Steady State)	外观 Appearance	无显著异常 No marked defect	电容器在温度 40±2℃，湿度 95±3%RH 下放置 500±12 小时。 试验前：电容器应放置在 85±2℃ (HR:125±2℃) 的温度下 1 小时，然后在常温下恢复 24±2 小时后测试。 试验后：在室内条件下恢复 24±2 小时。 Set the capacitor for 500±12 hours at 40±2℃ in 95±3% RH. pre-treatment: The capacitor shall be placed at 85±2℃ (HR:125±2℃) for 1 hour, then placed at room condition for 24±2 hours before initial measurement. Post-treatment: The capacitor shall be stored for 24±2 hours at room condition.
	容量变化 Capacitance Change	B: ±10% max R: ±15% max HR: -30~+15% max E: ±20% max F: ±30% max	
	损耗因数 D. F.	B、E: 5.0% max R、HR: 0.4% max F: 7.0% max	
	绝缘电阻 I. R.	大于 2500MΩ 2500MΩmin	

项目 ITEM	规格 SPECIFICATION		试验方法及条件 TEST METHOD AND CONDITION
18. 寿命试验 Life Test	外观 Appearance	无显著异常 No marked defect	施加 150%的额定电压并在 $85 \pm 2^{\circ}\text{C}$ ( $\text{HR}:125 \pm 2^{\circ}\text{C}$ )下放置 1000 小时。(充放电电流限于 50mA 以下) 试验前: 电容器应放置在 $85 \pm 2^{\circ}\text{C}$ ( $\text{HR}:125 \pm 2^{\circ}\text{C}$ )的温度下 1 小时, 然后在常温下恢复 $24 \pm 2$ 小时后测试。 试验后: 在室内条件下恢复 $24 \pm 2$ 小时。 Apply a DC voltage of 150% of the rated voltage for 1000 hours at $85 \pm 2^{\circ}\text{C}$ ( $\text{HR}:125 \pm 2^{\circ}\text{C}$ ). (Charge/discharge current $\leq 50\text{mA}$ ). pre-treatment: The capacitor shall be placed at $85 \pm 2^{\circ}\text{C}$ ( $\text{HR}:125 \pm 2^{\circ}\text{C}$ ) for 1 hour, then placed at room condition for $24 \pm 2$ hours before initial measurement. Post-treatment: Capacitor shall be stored for $24 \pm 2$ hours at room condition
	容量变化 Capacitance Change	B、E: $\pm 20\%$ max R: $\pm 30\%$ max HR: $-40\sim+20\%$ max F: $\pm 30\%$ max	
	损耗因数 D. F.	B、E: $5.0\%$ max R、HR: $0.4\%$ max F: $7.0\%$ max	
	绝缘电阻 I. R.	大于 $4000\text{M}\Omega$ $4000\text{M}\Omega\text{min}$	