

Working Voltage: 11 to 170 V
Peak Pulse Power: 600 W

Surface Mount Transient Voltage Suppressors

Features

- Glass passivated chip
- 600 W peak pulse power capability with a 10/1000 μ s waveform, repetitive rate (duty cycle):0.01 %
- High reliability application and automotive grade
- AEC Q101 qualified
- Low leakage
- Uni and Bidirectional unit
- Excellent clamping capability
- Very fast response time
- RoHS compliant

Mechanical Data

- Case: Molded plastic
- Epoxy: UL 94V-0 rate flame retardant
- Lead: Solderable per MIL-STD-750, method 2026
- Polarity: Color band denotes cathode end except Bipolar
- Mounting position: Any

SMB/ DO-214AA

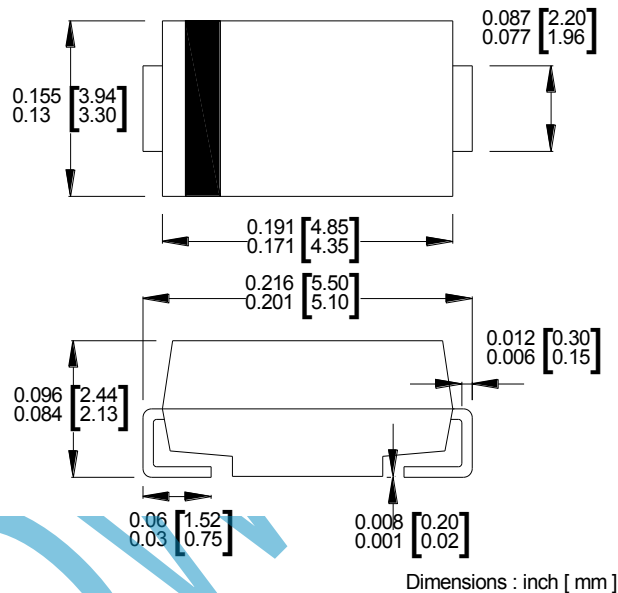

Maximum Ratings($T_A=25^\circ\text{C}$ unless otherwise noted)

Parameter	Symbol	Value	UNIT
Peak power dissipation with a 10/1000 μ s waveform ⁽¹⁾	P_{PP}	600	W
Peak pulse current with a 10/1000 μ s waveform ⁽¹⁾	I_{PP}	See Next Table	A
Power dissipation on infinite heatsink at $T_L = 75^\circ\text{C}$	P_D	5.0	W
Peak forward surge current, 8.3 ms single half sine-wave unidirectional only ⁽²⁾	I_{FSM}	100	A
Maximum instantaneous forward voltage at 50 A for unidirectional only ⁽³⁾	V_F	3.5/5.0	V
Operating junction and storage temperature range	T_J, T_{STG}	-55 to +150	$^\circ\text{C}$

Note:

(1) Non-repetitive current pulse per Fig.5 and derated above $T_A = 25^\circ\text{C}$ per Fig.1

(2) Measured on 8.3 ms single half sine-wave or equivalent square wave, duty cycle = 4 pulses per minute maximum

(3) $V_F < 3.5\text{V}$ for devices of $V_{BR} < 200\text{V}$ and $V_F < 5.0\text{V}$ for devices of $V_{BR} > 201\text{V}$

Ratings and Characteristics Curves ($T_A=25^\circ\text{C}$ unless otherwise noted)

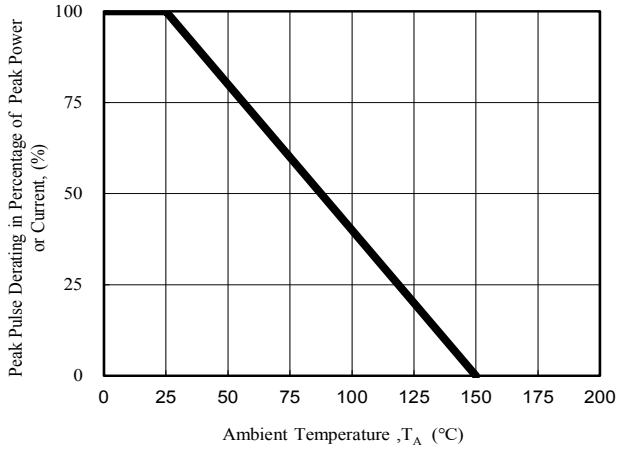

Fig. 1 - Pulse Derating Curve

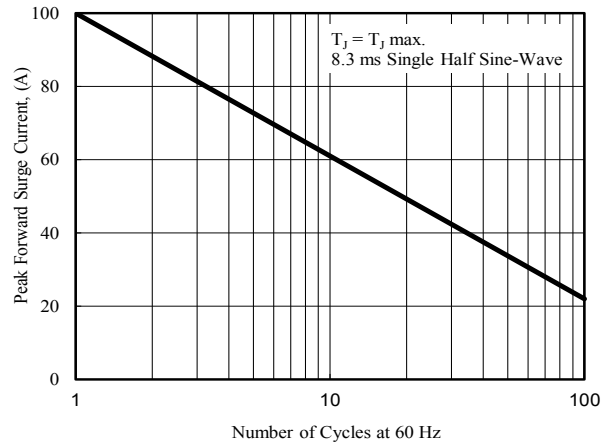

Fig. 2 - Maximum Non-Repetitive Surge Current

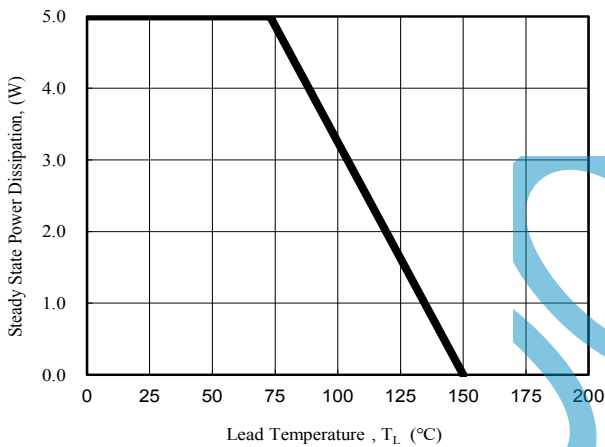

Fig. 3 - Steady State Power Derating Curve

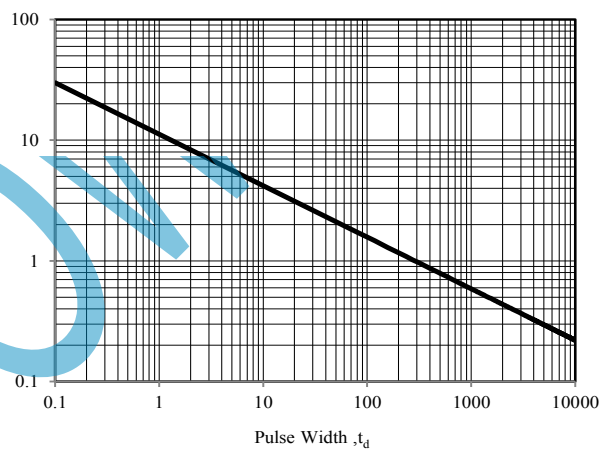

Fig. 4 - Peak Pulse Power Rating Curve

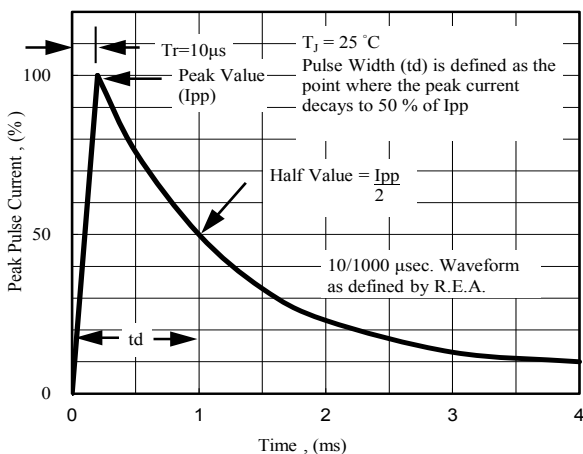

Fig. 5 - Pulse Waveform

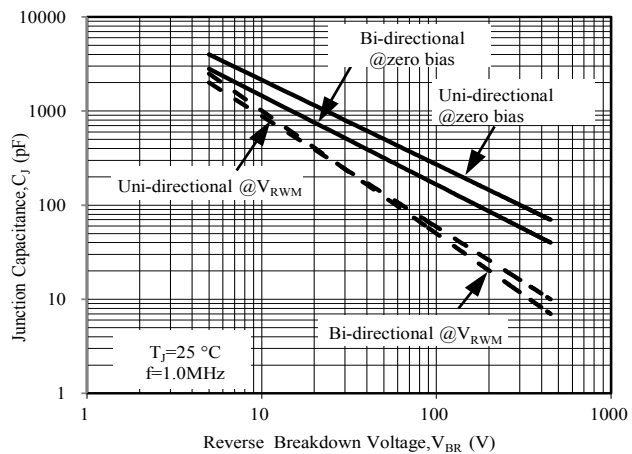

Fig. 6 - Typical Junction Capacitance

Electrical Characteristics($T_A=25^{\circ}\text{C}$ unless otherwise noted)

Part Number (Uni)	Part Number (Bi)	Device Marking Code		Breakdown Voltage V_{BR} @ I_T			Maximum Reverse Leakage I_R @ V_{RWM} (μA)	Working Peak Reverse Voltage V_{RWM} (V)	Maximum Reverse Surge Current I_{PP} (A)	Maximum Clamping Voltage V_C @ I_{PP} (V)
		Uni	Bi	Min (V)	Max (V)	I_T (mA)				
TPSMBJ11A	TPSMBJ11CA	KZA	AZA	12.20	13.50	1	1	11.0	32.97	18.2
TPSMBJ12A	TPSMBJ12CA	LEA	BEA	13.30	14.70	1	1	12.0	30.15	19.9
TPSMBJ13A	TPSMBJ13CA	LGA	BGA	14.40	15.90	1	1	13.0	27.91	21.5
TPSMBJ14A	TPSMBJ14CA	LKA	BKA	15.60	17.20	1	1	14.0	25.86	23.2
TPSMBJ15A	TPSMBJ15CA	LMA	BMA	16.70	18.50	1	1	15.0	24.59	24.4
TPSMBJ16A	TPSMBJ16CA	LPA	BPA	17.80	19.70	1	1	16.0	23.08	26.0
TPSMBJ17A	TPSMBJ17CA	LRA	BRA	18.90	20.90	1	1	17.0	21.74	27.6
TPSMBJ18A	TPSMBJ18CA	LTA	BTA	20.00	22.10	1	1	18.0	20.55	29.2
TPSMBJ19A	TPSMBJ19CA	LBA	BBA	21.10	23.30	1	1	19.0	19.49	30.8
TPSMBJ20A	TPSMBJ20CA	LVA	BVA	22.20	24.50	1	1	20.0	18.52	32.4
TPSMBJ22A	TPSMBJ22CA	LXA	BXA	24.40	26.90	1	1	22.0	16.90	35.5
TPSMBJ24A	TPSMBJ24CA	LZA	BZA	26.70	29.50	1	1	24.0	15.42	38.9
TPSMBJ26A	TPSMBJ26CA	MEA	CEA	28.90	31.90	1	1	26.0	14.25	42.1
TPSMBJ28A	TPSMBJ28CA	MGA	CGA	31.10	34.40	1	1	28.0	13.22	45.4
TPSMBJ30A	TPSMBJ30CA	MKA	CKA	33.30	36.80	1	1	30.0	12.40	48.4
TPSMBJ33A	TPSMBJ33CA	MMA	CMA	36.70	40.60	1	1	33.0	11.26	53.3
TPSMBJ36A	TPSMBJ36CA	MPA	CPA	40.00	44.20	1	1	36.0	10.33	58.1
TPSMBJ40A	TPSMBJ40CA	MRA	CRA	44.40	49.10	1	1	40.0	9.30	64.5
TPSMBJ43A	TPSMBJ43CA	MTA	CTA	47.80	52.80	1	1	43.0	8.65	69.4
TPSMBJ45A	TPSMBJ45CA	MVA	CVA	50.00	55.30	1	1	45.0	8.25	72.7
TPSMBJ48A	TPSMBJ48CA	MXA	CXA	53.30	58.90	1	1	48.0	7.75	77.4
TPSMBJ51A	TPSMBJ51CA	MZA	CZA	56.70	62.70	1	1	51.0	7.28	82.4
TPSMBJ54A	TPSMBJ54CA	NEA	DEA	60.00	66.30	1	1	54.0	6.89	87.1
TPSMBJ58A	TPSMBJ58CA	NGA	DGA	64.40	71.20	1	1	58.0	6.41	93.6
TPSMBJ60A	TPSMBJ60CA	NKA	DKA	66.70	73.70	1	1	60.0	6.20	96.8
TPSMBJ64A	TPSMBJ64CA	NMA	DMA	71.10	78.60	1	1	64.0	5.83	103.0
TPSMBJ70A	TPSMBJ70CA	NPA	DPA	77.80	86.00	1	1	70.0	5.31	113.0
TPSMBJ75A	TPSMBJ75CA	NRA	DRA	83.30	92.10	1	1	75.0	4.96	121.0
TPSMBJ78A	TPSMBJ78CA	NTA	DTA	86.70	95.80	1	1	78.0	4.76	126.0
TPSMBJ85A	TPSMBJ85CA	NVA	DVA	94.40	104.00	1	1	85.0	4.38	137.0
TPSMBJ90A	TPSMBJ90CA	NXA	DXA	100.00	111.00	1	1	90.0	4.11	146.0
TPSMBJ100A	TPSMBJ100CA	NZA	DZA	111.00	123.00	1	1	100.0	3.70	162.0
TPSMBJ110A	TPSMBJ110CA	PEA	EEA	122.00	135.00	1	1	110.0	3.39	177.0
TPSMBJ120A	TPSMBJ120CA	PGA	EGA	133.00	147.00	1	1	120.0	3.11	193.0
TPSMBJ130A	TPSMBJ130CA	PKA	EKA	144.00	159.00	1	1	130.0	2.87	209.0
TPSMBJ140A	TPSMBJ140CA	PBA	EBA	155.00	171.00	1	1	140.0	2.65	226.8
TPSMBJ150A	TPSMBJ150CA	PMA	EMA	167.00	185.00	1	1	150.0	2.47	243.0
TPSMBJ160A	TPSMBJ160CA	PPA	EPA	178.00	197.00	1	1	160.0	2.32	259.0
TPSMBJ170A	TPSMBJ170CA	PRA	ERA	189.00	209.00	1	1	170.0	2.18	275.0

Note:

1. Add suffix 'C' or 'CA' after part number to specify Bi-directional devices
2. For Bi-Directional devices having V_R of 10 volts and under, the I_R limit is double