



SS1020FL~SS10200FL

SURFACE MOUNT SCHOTTKY BARRIER RECTIFIER

VOLTAGE 20 to 200 Volt **CURRENT** 1 Ampere

SOD-123FL Unit : inch(mm)

FEATURES

- Fast switching speed
- Surface mount package ideally suited for automatic insertion
- Low power loss, high efficiency
- Lead free in compliance with EU RoHS 2.0
- Green molding compound as per IEC 61249 standard

MECHANICAL DATA

- Case: SOD-123FL, Plastic
- Terminals: Solderable per MIL-STD-750, Method 2026
- Apporx. Weight: 0.0006 ounces, 0.0173 grams
- Polarity: Color band denotes cathode end

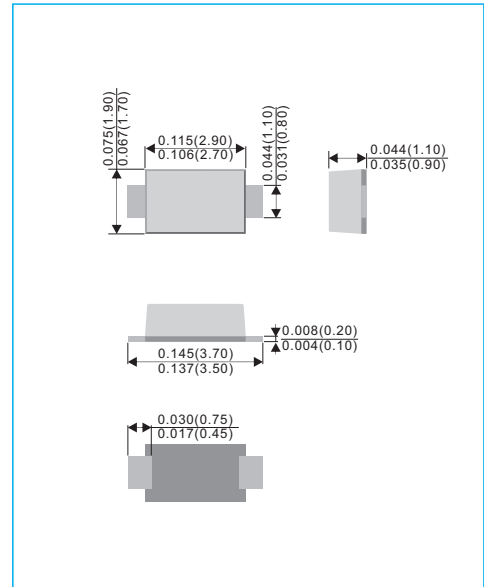
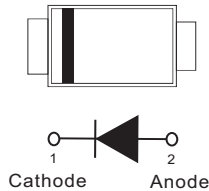

ABSOLUTE RATINGS (T_A=25°C unless otherwise noted)

PARAMETER	SYMBOL	SS1020FL	SS1030FL	SS1040FL	SS1060FL	SS10100FL	SS10150FL	SS10200FL	UNITS
Marking Code	-	G2	G3	G4	G6	G10	G15	G20	-
Reverse Voltage	V _R	20	30	40	60	100	150	200	V
Peak Reversr Voltage	V _{RRM}	20	30	40	60	100	150	200	V
Average Rectified Current	I _{F(AV)}	1							A
Forward Current RMS, D=0.5	I _{F(RMS)}	2							A
Non-repetitive Peak Forward Surge Current at t=8.3ms	I _{FSM}	40					30		A

ELECTRICAL AND THERMAL CHARACTERISTICS (T_A=25°C unless otherwise noted)

PARAMETER	SYMBOL	SS1020FL	SS1030FL	SS1040FL	SS1060FL	SS10100FL	SS10150FL	SS10200FL	UNITS
Minimum Reverse Breakdown Voltage at I _R =500μA	V _R	20	30	40	60	100	150	200	V
Maximum Forward Voltage at I _F =1A	V _F	0.55			0.7	0.8	0.85		V
Reverse Leakage Current at V _{RRM}	I _R	30							μA
Typical Thermal Resistance (Note 1) (Note 2)	R _{θJC} R _{θJA}	32				200			°C/W
Typical Junction Capacitance Rating at V _R =0V	C _J	155			125	100	85		pF
Operating Junction Temperature and Storage Temperature Range	T _J , T _{STG}	-55 to +150							°C

Note:1.Mounted on a FR4 PCB, single-sided copper, with 100cm² copper pad area
2.Mounted on a FR4 PCB, single-sided copper, mini pad.



SS1020FL~SS10200FL

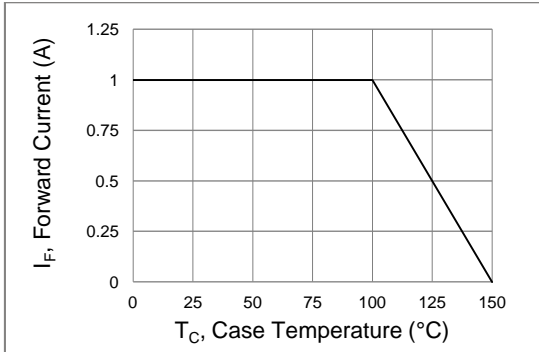

Fig.1 Forward Current Derating Curve

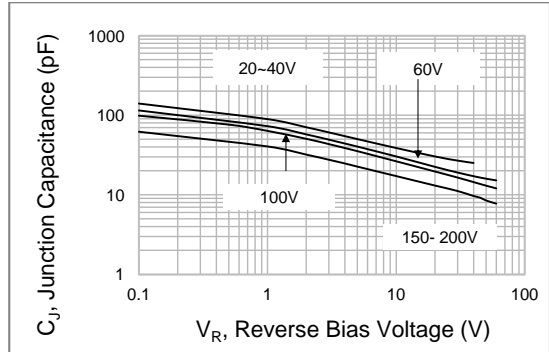

Fig.2 Typical Junction Capacitance

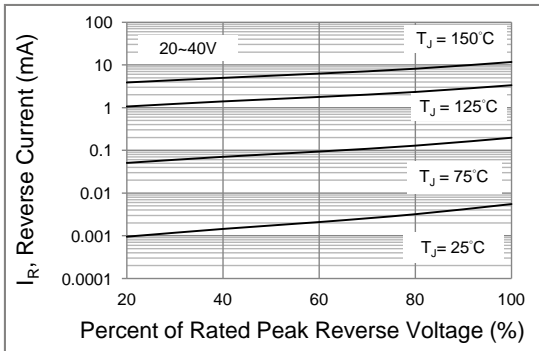

Fig.3 Typical Reverse Characteristics

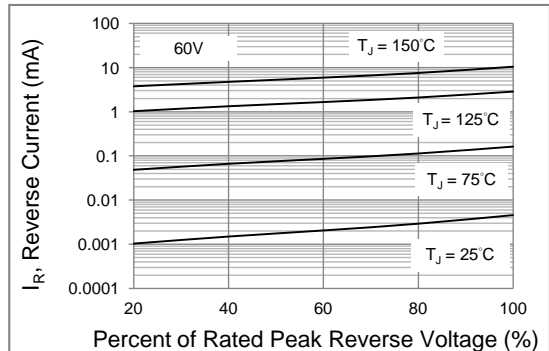

Fig.4 Typical Reverse Characteristics

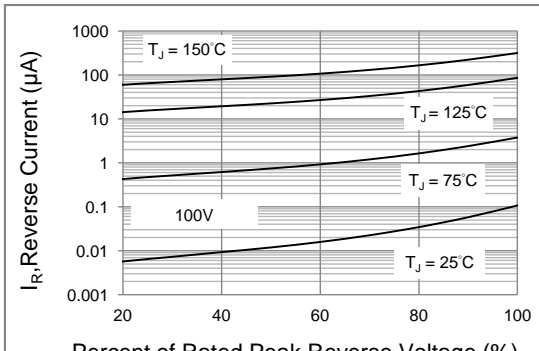

Fig.5 Typical Reverse Characteristics

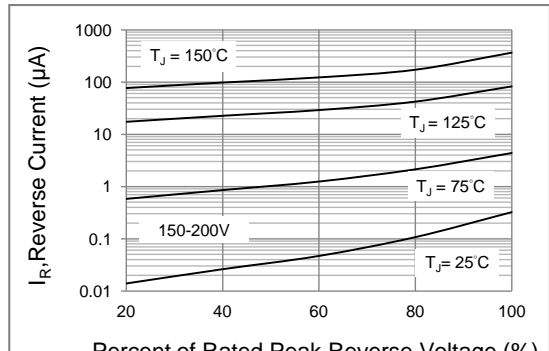

Fig.6 Typical Reverse Characteristics

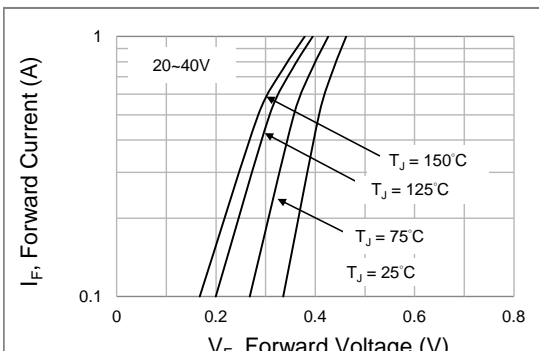

Fig.7 Typical Forward Characteristics

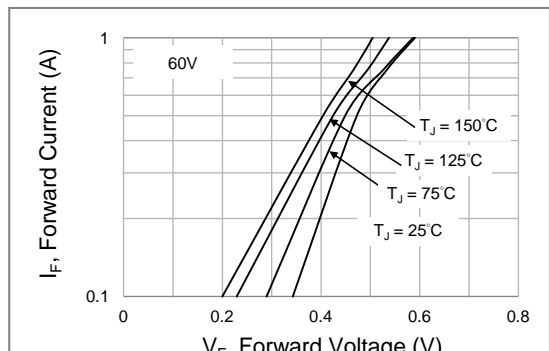

Fig.8 Typical Forward Characteristics



SS1020FL~SS10200FL

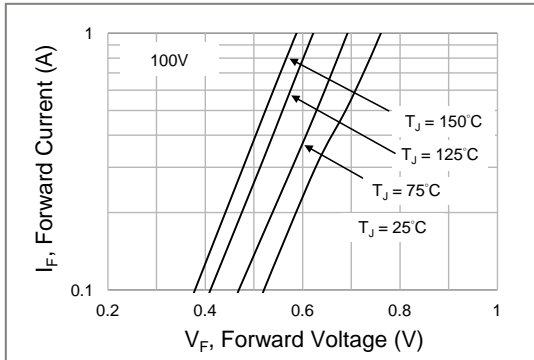

Fig.9 Typical Forward Characteristics

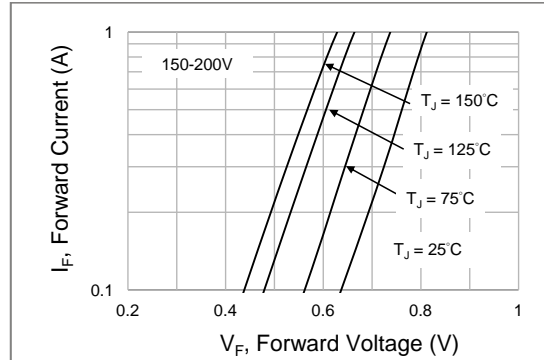

Fig.10 Typical Forward Characteristics

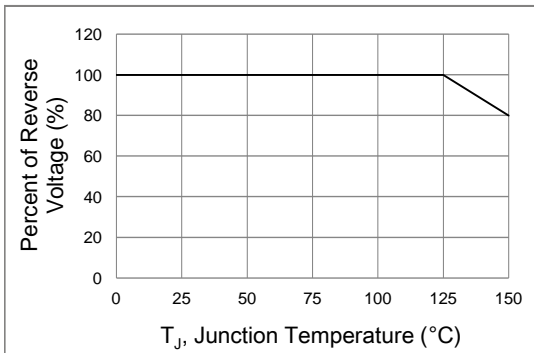
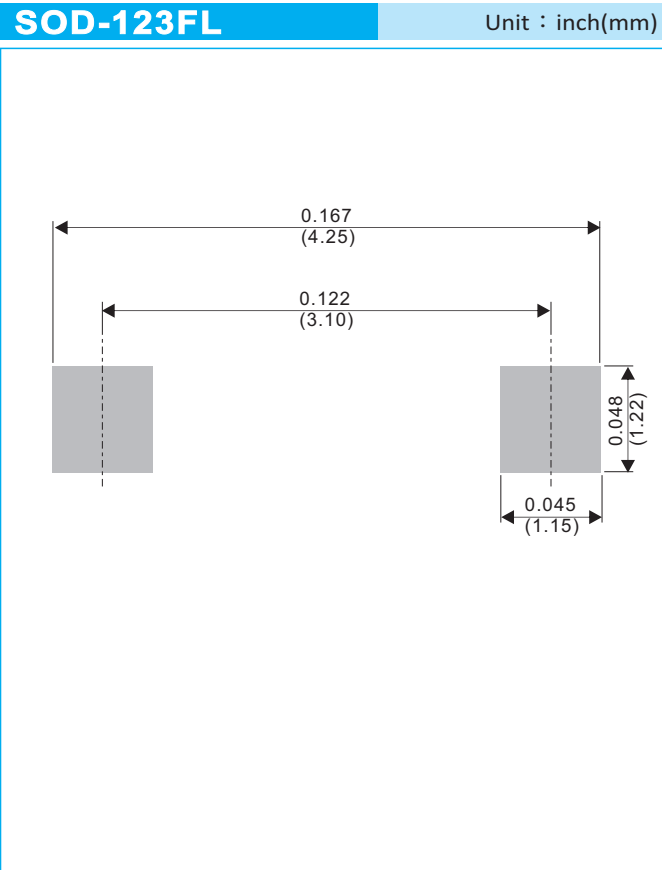

Fig.11 Operating Temperature Derating Curve



SS1020FL~SS10200FL

MOUNTING PAD LAYOUT



ORDER INFORMATION

- Packing information
T/R - 10K per 13" plastic Reel
T/R - 3K per 7" plastic Reel



SS1020FL~SS10200FL

Part No_packing code_Version

SS1020FL_R1_00001

SS1020FL_R2_00001

For example :

RB500V-40 **R2** **00001**



Packing Code XX				Version Code XXXXX		
Packing type	1 st Code	Packing size code	2 nd Code	HF or RoHS	1 st Code	2 nd ~5 th Code
Tape and Ammunition Box (T/B)	A	N/A	0	HF	0	serial number
Tape and Reel (T/R)	R	7"	1	RoHS	1	serial number
Bulk Packing (B/P)	B	13"	2			
Tube Packing (T/P)	T	26mm	X			
Tape and Reel (Right Oriented) (TRR)	S	52mm	Y			
Tape and Reel (Left Oriented) (TRL)	L	PANASERT T/B CATHODE UP (PBCU)	U			
FORMING	F	PANASERT T/B CATHODE DOWN (PBCD)	D			



SS1020FL~SS10200FL

Disclaimer

- Reproducing and modifying information of the document is prohibited without permission from Panjit International Inc..
- Panjit International Inc. reserves the rights to make changes of the content herein the document anytime without notification. Please refer to our website for the latest document.
- Panjit International Inc. disclaims any and all liability arising out of the application or use of any product including damages incidentally and consequentially occurred.
- Panjit International Inc. does not assume any and all implied warranties, including warranties of fitness for particular purpose, non-infringement and merchantability.
- Applications shown on the herein document are examples of standard use and operation. Customers are responsible in comprehending the suitable use in particular applications. Panjit International Inc. makes no representation or warranty that such applications will be suitable for the specified use without further testing or modification.
- The products shown herein are not designed and authorized for equipments requiring high level of reliability or relating to human life and for any applications concerning life-saving or life-sustaining, such as medical instruments, transportation equipment, aerospace machinery et cetera. Customers using or selling these products for use in such applications do so at their own risk and agree to fully indemnify Panjit International Inc. for any damages resulting from such improper use or sale.
- Since Panjit uses lot number as the tracking base, please provide the lot number for tracking when complaining.