

Aluminum Electrolytic Capacitors

Surface mount type



Notices

■ Applicable Laws and Regulations

- This product complies with the RoHS Directive (Restriction of the use of certain Hazardous substances in electrical and electronic equipment (DIRECTIVE 2011/65/EU).
- No Ozone Depleting Chemicals(ODC's), controlled under the Montreal Protocol Agreement, are used in producing this product.
- We do not use PBBs or PBDEs as brominated flame retardants.
- Export procedure which followed export related regulations, such as foreign exchange and a foreign trade method, on the occasion of export of this product.

■ Limited applications

- This capacitor is designed to be used for electronics circuits such as audio/visual equipment, home appliances, computers and other office equipment, optical equipment, measuring equipment.
- High reliability and safety are required [be / a possibility that incorrect operation of this product may do harm to a human life or property] more. When use is considered by the use, the delivery specifications which suited the use separately need to be exchanged.

Items to be observed

- This specification guarantees the quality and performance of the product as individual components. Before use, check and evaluate their compatibility with installed in your products.
- Do not use the products beyond the specifications described in this document.

■ For specifications

- Install the following systems for a failsafe design to ensure safety if these products are to be used in equipment where a defect in these products may cause the loss of human life or other signification damage, such as damage to vehicles (automobile, train, vessel), traffic lights, medical equipment, aerospace equipment, electric heating appliances, combustion/ gas equipment, rotating rotating equipment, and disaster/crime prevention equipment.
 - The system is equipped with a protection circuit and protection device.
 - The system is equipped with a redundant circuit or other system to prevent an unsafe status in the event of a single fault.

■ Conditions of use

- Before using the products, carefully check the effects on their quality and performance, and determined whether or not they can be used. These products are designed and manufactured for general-purpose and standard use in general electronic equipment. These products are not intended for use in the following special conditions.
 - (1) In liquid, such as Water, Oil, Chemicals, or Organic solvent.
 - (2) In direct sunlight, outdoors, or in dust.
 - (3) In vapor, such as dew condensation water of resistive element, or water leakage, salty air, or air with a high concentration corrosive gas, such as Cl₂, H₂S, NH₃, SO₂, or NO_x.
 - (4) In an environment where strong static electricity or electromagnetic waves exist.
 - (5) Mounting or placing heat-generating components or inflammables, such as vinyl-coated wires, near these products.
 - (6) Sealing or coating of these products or a printed circuit board on which these products are mounted, with resin and other material.
 - (7) Using solvent, water or water-soluble cleaner for flux cleaning agent after soldering. (In particular, when using water or a water-soluble cleaning agent, be careful not to leave water residues)
 - (8) Using in the atmosphere which strays Acid or alkaline.
 - (9) Using in the atmosphere which there are excessive vibration and shock.
- Please arrange circuit design for preventing impulse or transitional voltage. Do not apply voltage, which exceeds the full rated voltage when the capacitors receive impulse voltage, instantaneous high voltage, high pulse voltage etc.
- Our products there is a product are using an electrolyte solution. Therefore, misuse can result in rapid deterioration of characteristics and functions of each product. Electrolyte leakage damages printed circuit and affects performance, characteristics, and functions of customer system.

⚠ Application Guidelines (SMD Type)

1. Circuit design

1.1 Operating Temperature and Frequency

Electrical characteristics of the capacitor are likely to change due to variation in temperature and/or frequency. Circuit designers should take these changes into consideration.

- (1) Effects of operating temperature on electrical parameters
 - (a) At higher temperatures, leakage current and capacitance increase while equivalent series resistance (ESR) decreases.
 - (b) At lower temperatures, leakage current and capacitance decrease while equivalent series resistance (ESR) increases.
- (2) Effects of frequency on electrical parameters
 - (a) At higher frequencies, capacitance and impedance decrease while tan d increases.
 - (b) At lower frequencies, heat generated by ripple current will rise due to an increase in equivalent series resistance (ESR).

1.2 Operating Temperature and Life Expectancy

- (1) Expected life is affected by operating temperature. Generally, each 10 °C reduction in temperature will double the expected life.
Use capacitors at the lowest possible temperature below the upper category temperature.
- (2) If operating temperatures exceed the upper category limit, rapid deterioration of electrical parameter will occur and irreversible damage will result.
Check for the maximum capacitor operating temperatures including ambient temperature, internal capacitor temperature rise due to ripple current, and the effects of radiated heat from power transistors, IC's or resistors. Avoid placing components, which could conduct heat to the capacitor from the back side of the circuit board.
- (3) The formula for calculating expected life at lower operating temperatures is as follows ;

$$L_2 = L_1 \times 2^{\left(\frac{T_1 - T_2}{10}\right)}$$

L_1 : Guaranteed life (h) at temperature, T_1 °C

L_2 : Expected life (h) at temperature, T_2 °C

T_1 : Upper category temperature (°C)

T_2 : Actual operating temperature, ambient temperature + temperature rise due to ripple current (°C)

- (4) Please use according to the lifetime as noted in this specification. Using products beyond end of the lifetime may change characteristics rapidly, short-circuit, operate pressure relief vent, or leak electrolyte.

1.3 Common Application Conditions to Avoid

The following misapplication load conditions will cause rapid deterioration of a capacitor's electrical parameters. In addition, rapid heating and gas generation within the capacitor can occur, causing the pressure relief vent to operate and resultant leakage of electrolyte. Under extreme conditions, explosion and fire ignition could result. The leaked electrolyte is combustible and electrically conductive.

- (1) Reverse Voltage
DC capacitors have polarity. Therefore, please do not apply the reverse voltage. Verify correct polarity before insertion.
For circuits with changing or uncertain polarity, use DC bipolar capacitors. DC bipolar capacitors are not suitable for use in AC circuits.
- (2) Charge / Discharge Applications
Standard capacitors are not suitable for use in repeating charge/discharge applications. For charge/discharge applications, consult us with your actual application condition.
For rush current, please do not exceed 100 A.
- (3) ON-OFF circuit
Do not use capacitors in circuit where ON-OFF switching is repeated more than 10000 times/per day.
In case of applying to theses ON-OFF circuit, consult with us about circuit condition and so on.
- (4) Over voltage
Do not apply voltages exceeding the maximum specified rated voltage. Voltages up to the surge voltage rating are acceptable for short periods of time.
Ensure that the sum of the DC voltage and the superimposed AC ripple voltage does not exceed the rated voltage.

(5) Ripple Current

Do not apply ripple currents exceeding the maximum specified value. For high ripple current applications, use a capacitor designed for high ripple currents. In addition, consult us if the applied ripple current is to be higher than the maximum specified value.

Ensure that rated ripple currents that superimposed on low DC bias voltages do not cause reverse voltage conditions.

Even if it is within a rated ripple current, in case the practical use is over the pre described endurance life time, it causes the increase of deterioration of ESR characteristic and the internal generation heat by ripple current.

Due to this, there is some possibility of vent open, bulging of sleeve and rubber, electrolyte leakage, and shot circuit, explosion and ignition in the worst case.

1.4 Using Two or More Capacitors in Series or Parallel

(1) Capacitors Connected in Parallel

The circuit resistance can closely approximate the series resistance of the capacitor, causing an imbalance of ripple current loads within the capacitors. Careful wiring methods can minimize the possible application of an excessive ripple current to a capacitor.

(2) Capacitors Connected in Series

Differences in normal DC leakage current among capacitors can cause voltage imbalances.

The use of voltage divider shunt resistors with consideration to leakage currents can prevent capacitor voltage imbalances.

NOTE : Please do not use in the series in the case of conductive polymer hybrid aluminum electrolytic capacitor.

1.5 Capacitor Mounting Considerations

(1) Double-Sided Circuit Boards

Avoid wiring pattern runs, which pass between the mounted capacitor and the circuit board.

(2) Clearance for Case Mounted Pressure Relief ($\geq \phi 10$ mm)

Capacitors with case mounted pressure relief require sufficient clearance to allow for proper pressure relief operation.

The minimum clearance are dependent on capacitor diameters as follows.

(Dia 10 mm to Dia 16 mm : 2 mm minimum, Dia 18 mm : 3 mm minimum)

(3) Wiring Near the Pressure Relief ($\geq \phi 10$ mm)

Avoid locating high voltage or high current wiring or circuit board paths above the pressure relief. Flammable, high temperature gas that exceeds 100 °C may be released which could dissolve the wire insulation and ignite.

(4) Circuit Board Patterns Under the Capacitor

Avoid circuit board runs under the capacitor, as an electrical short can occur due to an electrolyte leakage.

1.6 Electrical Isolation of the Capacitor

Completely isolate the capacitor as follows.

Between the cathode and the case and between the anode terminal and other circuit paths.

1.7 Capacitor Coating

The laminate coating is intended for marking and identification purposes and is not meant to electrically insulate the capacitor.

2. Capacitor Handling Techniques

2.1 Considerations Before Using

(1) Capacitors have a finite life. Do not reuse or recycle capacitors from used equipment.

(2) Transient recovery voltage may be generated in the capacitor due to dielectric absorption.

If required, this voltage can be discharged with a resistor with a value of about 1 k Ω .

(3) Capacitors stored for a long period of time may exhibit an increase in leakage current.

This can be corrected by gradually applying rated voltage in series with a resistor of approximately 1 k Ω .

(4) If capacitors are dropped, they can be damaged mechanically or electrically. Avoid using dropped capacitors.

(5) Dented or crushed capacitors should not be used. The seal integrity can be damaged and loss of electrolyte/ shortened life can result.

2.2 Capacitor Insertion

(1) Verify the correct capacitance and rated voltage of the capacitor.

(2) Verify the correct polarity of the capacitor before insertion.

(3) Verify the correct hole spacing and land pattern size before insertion to avoid stress on the terminals.

(4) Excessive mounting pressure can cause high leakage current, short circuit, or disconnection.

2.3 Reflow Soldering

- (1) Surface-mount type capacitor are exclusively for reflow soldering.
When reflow solder is used an ambient heat condition system such as the simultaneous use of infrared and hot-air is recommended.
- (2) Observe proper soldering conditions (temperature, time, time of reflow, etc.). Do not exceed the specified limits.
* The Temperature on Capacitor top shall be measured by using thermal couple that is fixed firmly by epoxy glue.
- (3) In case of use in 2 times reflow, 2nd reflow must be done when the capacitor's temperature return back to normal level.
- (4) In our recommended reflow condition, the case discoloration and the case swelling might be slightly generated.
But please acknowledge that these two phenomena do not influence the reliability of the product.
- (5) The crack on top marking might be occurred by reflow heat stress.
But please acknowledge that it does not influence the reliability of the product.
- (6) VPS (Vapor Phase Soldering) reflow can cause significant characteristics change and/ or mounting failure due to deformation by acute temperature rise.
VPS is acceptable provided that the process does not exceed recommended reflow profile and temperature rise is less than 3 degC/ sec.
Please contact Panasonic for detailed conditions.

2.4 Manual Soldering

- (1) Observe temperature and time soldering specifications or do not exceed temperature of 350 °C for 3 seconds or less.
- (2) If a soldered capacitor must be removed and reinserted, avoid excessive stress on the capacitor leads.
- (3) Avoid physical contacts between the tip of the soldering iron and capacitors to prevent or capacitor failure.

2.5 Capacitor Handling after Soldering

- (1) Avoid moving the capacitor after soldering to prevent excessive stress on the lead wires where they enter the seal.
The capacitor may break from element portion due to a torque at outer rim, causing a large stress to terminals.
- (2) Do not use the capacitor as a handle when moving the circuit board assembly. The total weight of the board would apply to element portion through terminals, and the capacitor may break.
- (3) Avoid striking the capacitor after assembly to prevent failure due to excessive shock. The capacitor may break due to excessive shock or load above specified range.

2.6 Circuit Board Cleaning

- (1) Circuit boards can be immersed or ultrasonically cleaned using suitable cleaning solvents for up to 5 minutes and up to 60 °C maximum temperatures. The boards should be thoroughly rinsed and dried.
The use of ozone depleting cleaning agents is not recommended for the purpose of protecting our environment.
- (2) Avoid using the following solvent groups unless specifically allowed in the specification ;
 - (a) Halogenated cleaning solvents: except for solvent resistant capacitor types, halogenated solvents can permeate the seal and cause internal capacitor corrosion and failure.
For solvent resistant capacitors, carefully follow the temperature and time requirements based on the specification.
1,1,1-trichloroethane should never be used on any aluminum electrolytic capacitor.
 - (b) Alkaline solvents : could react and dissolve the aluminum case.
 - (c) Petroleum based solvents : deterioration of the rubber seal could result.
 - (d) Xylene : deterioration of the rubber seal could result.
 - (e) Acetone : removal of the ink markings on the vinyl sleeve could result.
- (3) A thorough drying after cleaning is required to remove residual cleaning solvents that may be trapped between the capacitor and the circuit board. Avoid drying temperatures, which exceed the Upper category temperature of the capacitor.
- (4) Monitor the contamination levels of the cleaning solvents during use in terms of electrical conductivity, pH, specific gravity, or water content. Chlorine levels can rise with contamination and adversely affect the performance of the capacitor. Control the flux density in the cleaning agent to be less than 2 mass%.
- (5) Depending on the cleaning method, the marking on a capacitor may be erased or blurred.
Please consult us if you are not certain about acceptable cleaning solvents or cleaning methods.

2.7 Mounting Adhesives and Coating Agents

When using mounting adhesives or coating agents to control humidity, avoid using materials containing halogenated solvents.

Also, avoid the use of chloroprene based polymers.

Hardening on dry adhesive or coating agents well lest the solvent should be left.

After applying adhesives or coatings, dry thoroughly to prevent residual solvents from being trapped between the capacitor and the circuit board.

2.8 Fumigation

In exporting electronic appliances with aluminum electrolytic capacitors, in some cases fumigation treatment using such halogen compound as methyl bromide is conducted for wooden boxes.

If such boxes are not dried well, the halogen left in the box is dispersed while transported and enters in the capacitors inside. This possibly causes electrical corrosion of the capacitors. Therefore, after performing fumigation and drying make sure that no halogen is left.

Don't perform fumigation treatment to the whole electronic appliances packed in a box.

Leave more than 1/3 of the sealing portion open, and do not cover that portion with any adhesives or coating.

3. Precautions for using capacitors

3.1 Environmental Conditions

Capacitors should not be used in the following environments.

- (1) Exposure to temperatures above the upper category or below the lower category temperature of the capacitor.
- (2) Direct contact with water, salt water, or oil.
- (3) High humidity conditions where water could condense on the capacitor.
- (4) Exposure to toxic gases such as hydrogen sulfide, sulfuric acid, nitric acid, chlorine, Chlorine compound, Bromine, Bromine compound or ammonia.
- (5) Exposure to ozone, radiation, or ultraviolet rays.
- (6) Vibration and shock conditions exceeding specified requirements.

3.2 Electrical Precautions

- (1) Avoid touching the terminals of a capacitor as a possible electric shock could result. The exposed aluminum case is not insulated and could also cause electric shock if touched.
- (2) Avoid short circuiting the area between the capacitor terminals with conductive materials including liquids such as acids or alkaline solutions.
- (3) A low-molecular-weight-shiroxane which is included in a silicon material shall causes abnormal electrical characteristics.

4. Emergency Procedures

- (1) If the pressure relief of the capacitor operates, immediately turn off the equipment and disconnect from the power source.
This will minimize an additional damage caused by the vaporizing electrolyte.
- (2) Avoid contact with the escaping electrolyte gas, which can exceed 100 °C temperatures.
If electrolyte or gas enters the eye, immediately flush the eye with large amounts of water.
If electrolyte or gas is ingested by mouth, gargle with water.
If electrolyte contacts the skin, wash with soap and water.

5. Long Term Storage

Leakage current of a capacitor increases with long storage times. The aluminum oxide film deteriorates as a function of temperature and time.

If used without reconditioning, an abnormally high current will be required to restore the oxide film.

This surge current could cause the circuit or the capacitor to fail.

Expiration date is 42 months from outgoing inspection date.

However, expiration date for series which are not listed below is 12 months from outgoing inspection date.

Series	Expiration date
S (only High temperature reflow) HA (only High temperature reflow) HB (only High temperature reflow and 5.4 mm height) HC, HD, FCA, FC, FKA, FK, FKS, FP, FT, TG, TK, TP, TC, TCU, TQ	42 months from outgoing inspection date

For storage condition, keep room temperature (5 °C to 35 °C) and humidity (45 % to 85 %) where direct sunshine doesn't reach.

5.1 Environmental Conditions

Do not store under condition outside the area described in the specification, and also under conditions listed below.

- (1) Exposure to temperatures above the upper category or below the lower category temperature of the capacitor.
- (2) Direct contact with water, salt water, or oil.
- (3) High humidity conditions where water could condense on the capacitor.
- (4) Exposure to toxic gases such as hydrogen sulfide, sulfuric acid, nitric acid, chlorine, Chlorine compound, Bromine, Bromine compound or ammonia.
- (5) Exposure to ozone, radiation, or ultraviolet rays.
- (6) Vibration and shock conditions exceeding specified requirements.

6. Capacitor Disposal

When disposing capacitors, use one of the following methods.

- (1) Incinerate after crushing the capacitor or puncturing the can wall (to prevent explosion due to internal pressure rise).
- (2) Dispose as solid waste.

NOTE : Local laws may have specific disposal requirements which must be followed.

Diagram

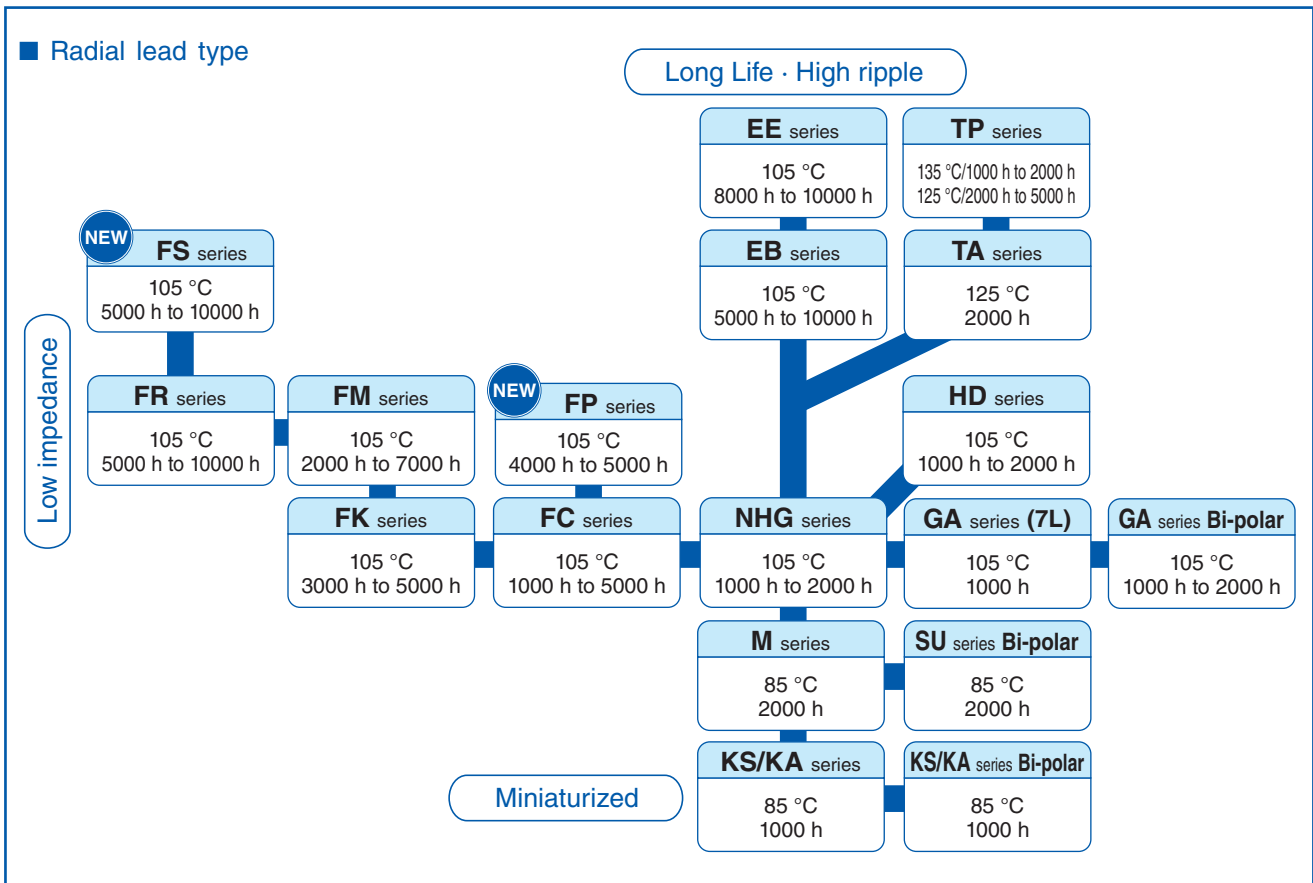
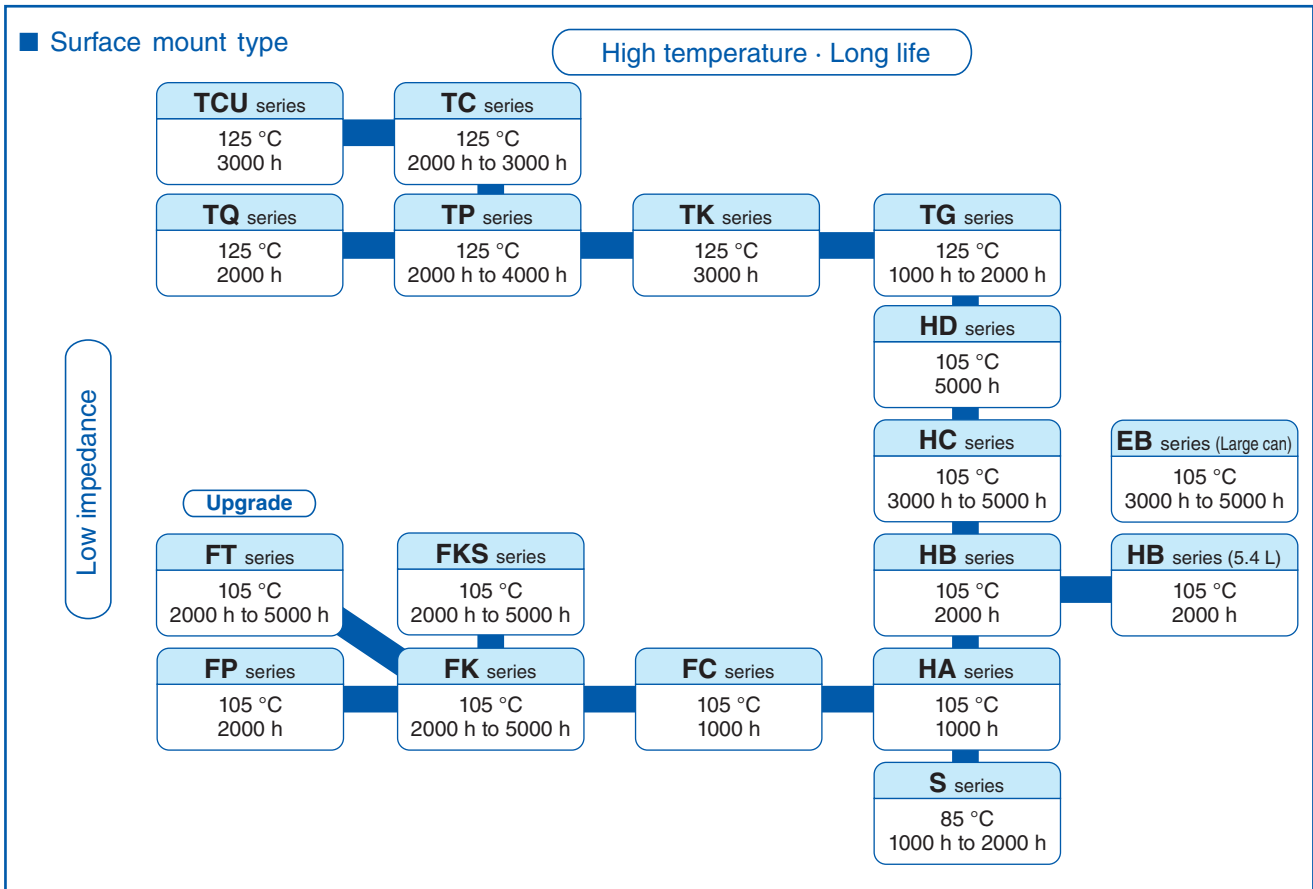

Explanation of part numbers

Part number system

◇ Hybrid

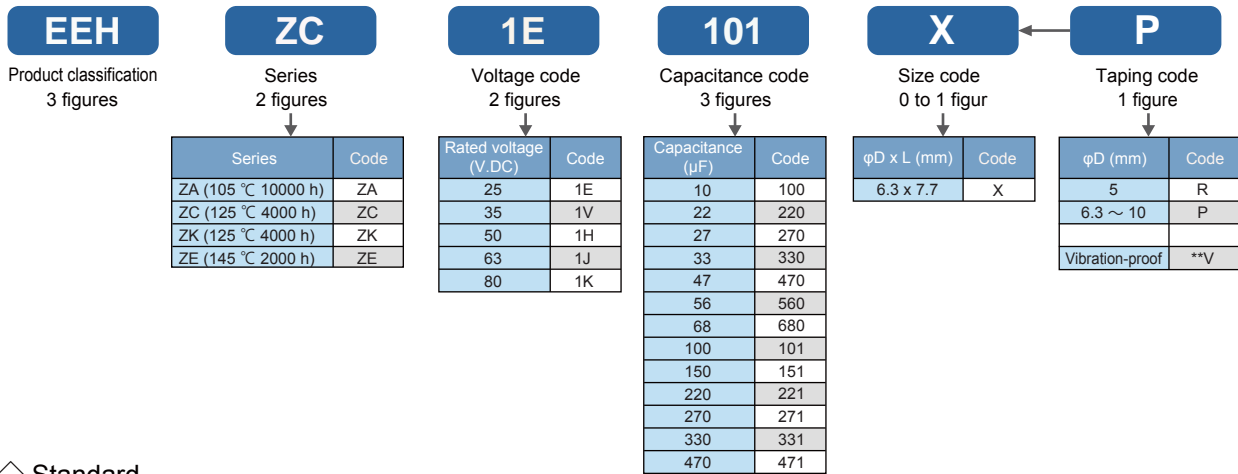

◇ Standard

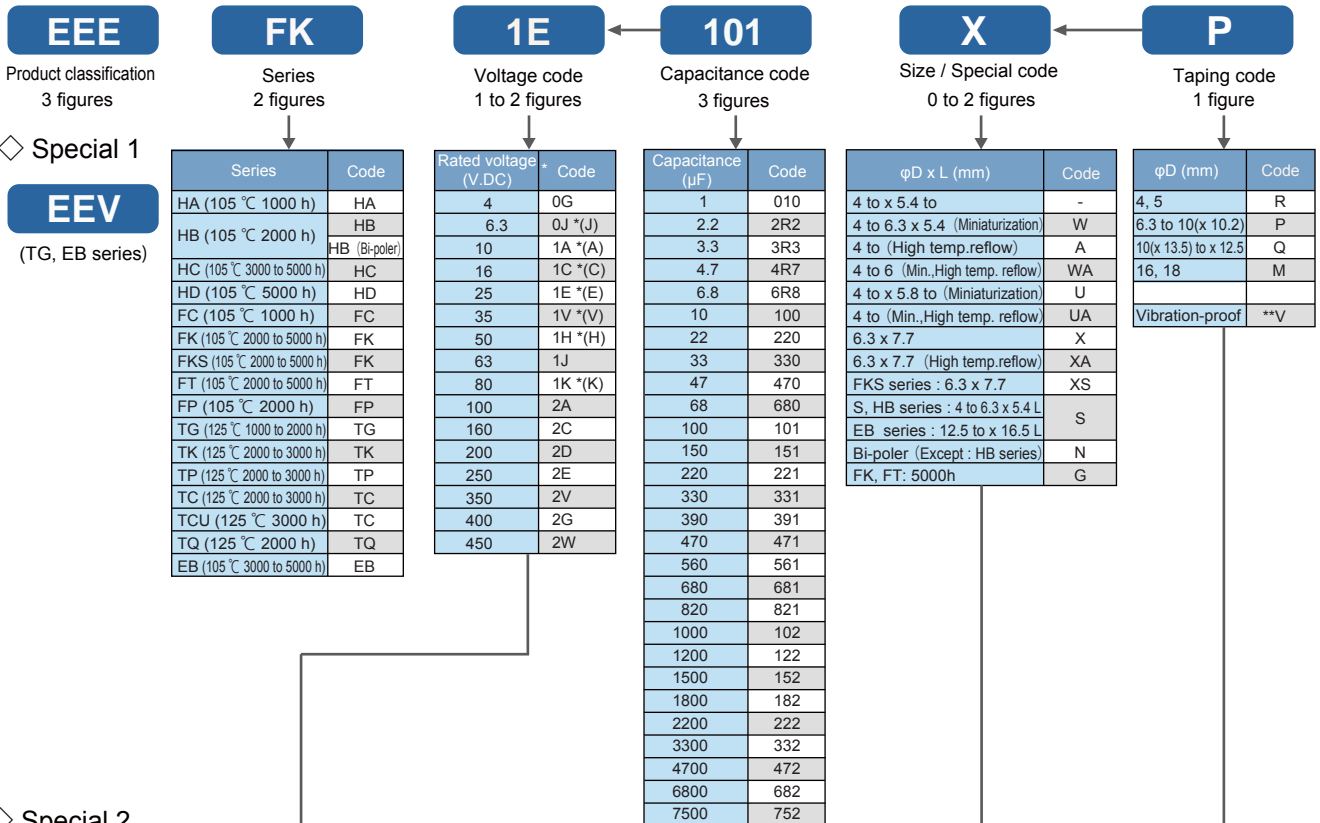

◇ Special 2

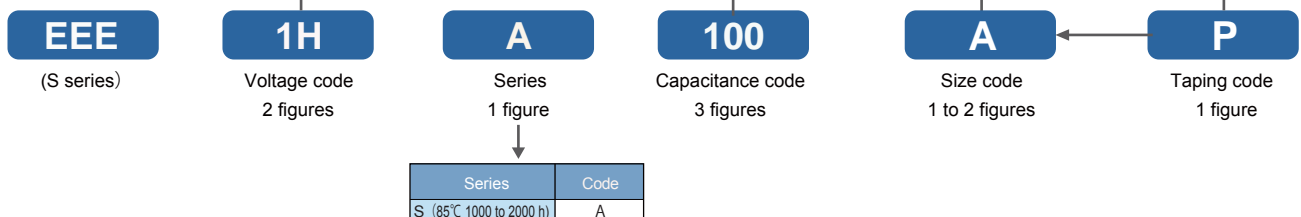

Note) * If part number exceeds 12 figures, voltage code is abbreviated as follows, 0J → J, 1A → A, 1C → C, 1E → E, 1V → V, 1H → H

** Vibration-proof product is available upon request. (Dia.8 mm and larger) When requesting vibration-proof product, please put the last "V" instead of "P, Q, or M".

Recommendable reflow soldering

- RoHS compliant

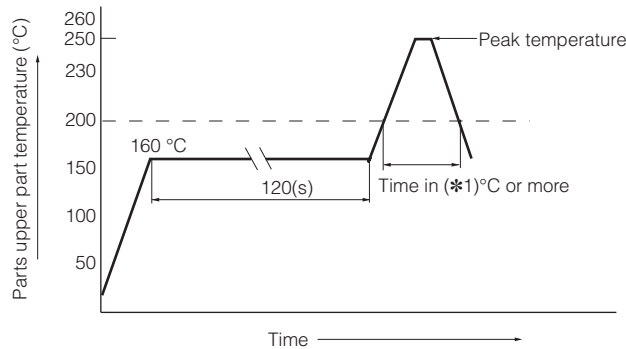

Lead-Free reflow

Reflow No.	Fig. (1)	Fig. (2)	Fig. (3)	Fig. (4)
Category	φ4 to φ6.3	φ8 to φ10	φ12.5 to φ18	EB series (φ10 to φ18)
Peak temperature	250 °C	235 °C	230 °C (220 °C)	230 °C
Time in peak temperature	5 s	5 s	5 s (5 s)	5 s
Time in (*1) °C or more	≥200 °C 60 s	≥200 °C 60 s	≥200 °C 20 s (30 s)	≥200 °C 20 s
Time of reflow	1 time	1 time	1 time	1 time

High temperature Lead-Free reflow

Reflow No.	Fig. (5)	Fig. (6)		Fig. (7)		Fig. (8)	
Category	φ4 to φ6.3	φ8 to φ10		φ8 to φ10		φ6.3 to φ10 (TK · TP series)	
Peak temperature	260 °C (255 °C)	245 °C	260 °C	250 °C	260 °C	255 °C	260 °C
Time in peak temperature	≥250 °C 5 s (10 s)	≥240 °C 10 s	≥250 °C 5 s	≥240 °C 10 s	≥250 °C 5 s	≥250 °C 30 s	≥250 °C 20 s
Time in (*1) °C or more	≥230 °C 30 s	≥230 °C 30 s	≥230 °C 30 s	≥230 °C 30 s	≥230 °C 30 s	≥230 °C 40 s	≥230 °C 30 s
	≥217 °C 40 s	≥217 °C 40 s	≥217 °C 40 s	≥217 °C 40 s	≥217 °C 40 s	≥217 °C 65 s	≥217 °C 65 s
	≥200 °C 70 s	≥200 °C 70 s	≥200 °C 70 s	≥200 °C 70 s	≥200 °C 70 s	≥200 °C 90 s	≥200 °C 70 s
Time of reflow	2 times	2 times	1 time	2 times	1 time	2 times	2 times

Reflow No.	Fig. (9)	Fig. (10)	Fig. (11)
Category	φ12.5 to φ18 (FK, TK, HD series) 6.3 V.DC to 35 V.DC	φ12.5 to φ18 (FK series) 50 V.DC to 63 V.DC (TK series) 50 V.DC	φ12.5 to φ18 (FK series) 80 V.DC to 100 V.DC (TK series) 63 V.DC to 100 V.DC
Peak temperature	245 °C	245 °C	245 °C
Time in peak temperature	≥240 °C 30 s	≥240 °C 5 s	≥240 °C 5 s
Time in (*1) °C or more	≥217 °C 90 s	≥217 °C 30 s	≥217 °C 30 s
Time of reflow	2 times	2 times	1 time

* For reflow, use a thermal condition system such as infrared radiation (IR) or hot blast.

* Panasonic have several series available for pure Tin terminal and ZVEI reflow based on J-STD-020D (JEDEC). (Please contact sales for details.)

Dimensions (Vibration-proof products)

* The size and shape are different from standard products. Please inquire details of our company.

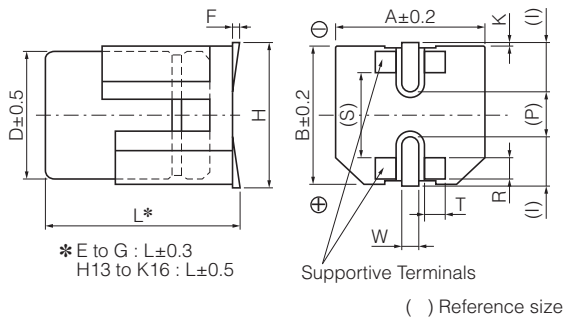

(Unit : mm)

Size code	φD	L	A, B	H max.	F	I	W	P	K	R	S	T
E	8.0	6.5	8.3	9.5	0 to +0.15	3.4	0.7±0.1	2.2	0.35 ^{+0.15} _{-0.20}	0.70±0.2	5.3±0.2	1.7±0.2
F	8.0	10.5	8.3	10.0	0 to +0.15	3.4	1.2±0.2	3.1	0.70±0.2	0.70±0.2	5.3±0.2	1.3±0.2
G	10.0	10.5	10.3	12.0	0 to +0.15	3.5	1.2±0.2	4.6	0.70±0.2	0.70±0.2	6.9±0.2	1.3±0.2
H13	12.5	13.8	13.5	15.0	-0.1 to +0.15	4.7	1.2±0.2	4.4	0.70±0.3	2.2±0.2	7.1±0.2	2.4±0.2
J16	16.0	16.8	17.0	19.0	-0.1 to +0.15	5.5	1.4±0.2	6.7	0.70±0.3	3.0±0.2	9.0±0.2	1.9±0.2
K16	18.0	16.8	19.0	21.0	-0.1 to +0.15	6.7	1.4±0.2	6.7	0.70±0.3	3.0±0.2	11.0±0.2	1.9±0.2

Land/Pad pattern

The circuit board land/pad pattern size for chip capacitors is specified in the following table. The land pitch influences installation strength and consider it.

Standard products

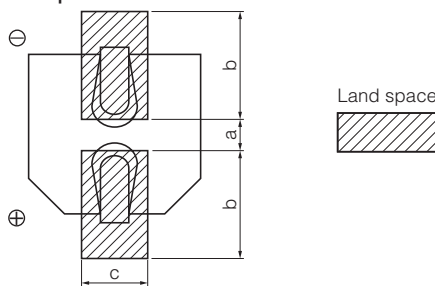

[Table of board land size vs. capacitor size]

(Unit : mm)

Size code (Dimensions)	a	b	c
B (φ4)	1.0	2.5	1.6
C (φ5)	1.5	2.8	1.6
D (φ6.3)	1.8	3.2	1.6
E (φ8 × 6.2L)	2.2	4.0	1.6
F (φ8 × 10.2L)	3.1	4.0	2.0
G (φ10 × 10.2L)	4.6	4.1	2.0
H (φ12.5)	4.0	5.7	2.0
J (φ16)	6.0	6.5	2.5
K (φ18)	6.0	7.5	2.5

* When size "a" is wide, back fillet can be made, decreasing fitting strength.

Vibration-proof products

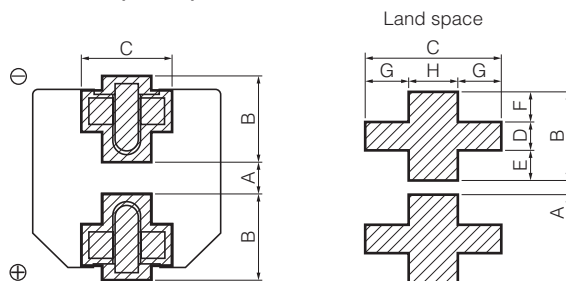

[Table of board land size vs. capacitor size]

(Unit : mm)

Size code (Dimensions)	A	B	C	D	E	F	G	H
E (φ8 × 6.5L)	1.8	4.2	5.0	1.3	1.5	1.4	1.5	2.0
F (φ8 × 10.5L)	2.7	4.0	4.7	1.3	1.0	1.7	1.1	2.5
G (φ10)	3.9	4.4	4.7	1.3	1.2	1.9	1.1	2.5
H (φ12.5)	3.9	6.0	6.9	2.8	1.3	1.9	2.2	2.5
J (φ16)	5.8	6.8	6.2	3.6	1.3	1.9	1.7	2.8
K (φ18)	5.8	7.3	6.2	3.6	1.8	1.9	1.7	2.8

* When size "A" is wide, back fillet can be made, decreasing fitting strength.

* Take mounting conditions, solderability and fitting strength into consideration when selecting parts for your company's design.

Expected life estimate quick reference guide

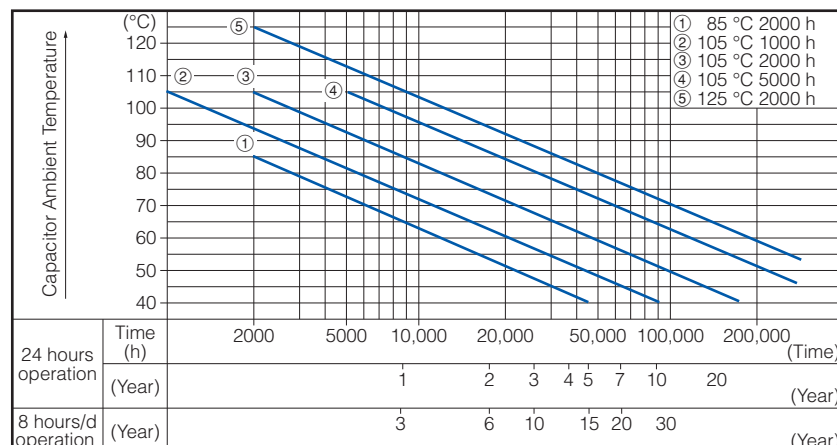

Packaging specifications

● Reel dimensions

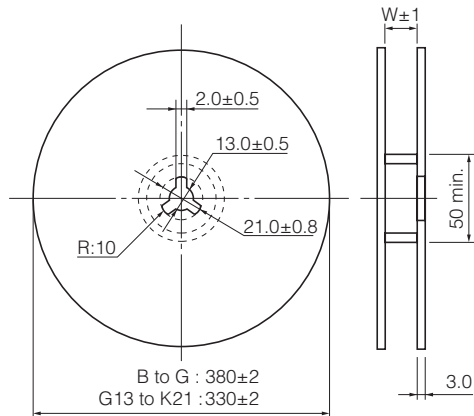

Size code	W	Size code	W
B, C	14	G13, G17	34
D, E, D8	18	H13, H16	34
F, G	26	J16, J21	46
		K16, K21	46

● Dimensions of outer carton box

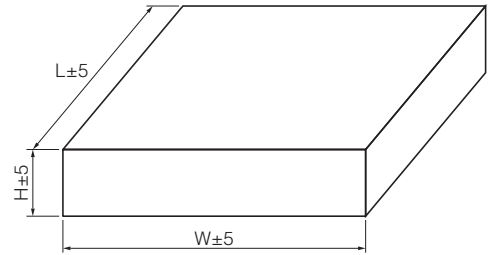

Unit : mm

Size code	H	W, L
B, C	220	395
D, D8, E	250	395
F, G	220	395
G13, G17	210	350
H13, H16		
J16, J21	230	350
K16, K21		

● Taping dimensions (size B to G)

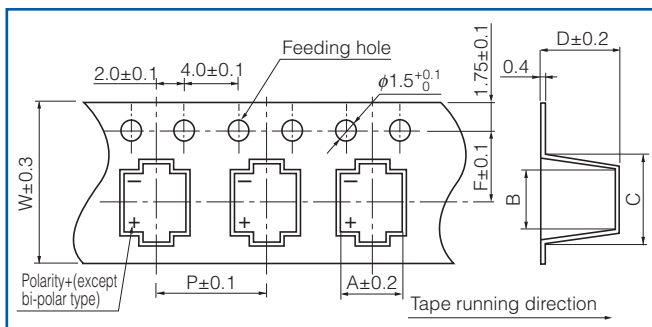

Ask factory for technical specifications.

● Min.packing quantity

Size code	Height	Min.packing quantity pcs.
		380 mm reel
B	L=5.4 mm	2000
	L=5.8 mm	2000
C, D	L=5.4 mm	1000
	L=5.8 mm	1000
E	-	1000
D8	-	900
F, G	-	500

Size code	Min.packing quantity pcs.
	330 mm reel
G13	250
G17, H13	200
H16	150
J16, K16	125
J21, K21	75

Size code	W	A	B	C	P	F	D	
							Height	
							L=5.4 mm	L=5.8 mm
B	12.0	4.7	4.6 ^{+0.2} _{-0.1}	6.5±0.3	8.0	5.5	5.8	6.2
C	12.0	5.7	5.7 ^{+0.3} _{-0.2}	8.0±0.5	12.0	5.5	5.8	6.4
D	16.0	7.0	7.0 ^{+0.3} _{-0.2}	9.0±0.5	12.0	7.5	5.8	6.4
D8	16.0	7.0	7.0 ^{+0.3} _{-0.2}	9.0±0.5	12.0	7.5	8.4	
E	16.0	8.7	8.7 ^{+0.3} _{-0.2}	11.4±0.5	12.0	7.5	6.8	
F	24.0	8.7	8.7 ^{+0.3} _{-0.2}	12.5±0.5	16.0	11.5	11.0	
G	24.0	10.7	10.7 ^{+0.3} _{-0.2}	14.5±0.5	16.0	11.5	11.0	

● Taping dimensions (size G13 to K21)

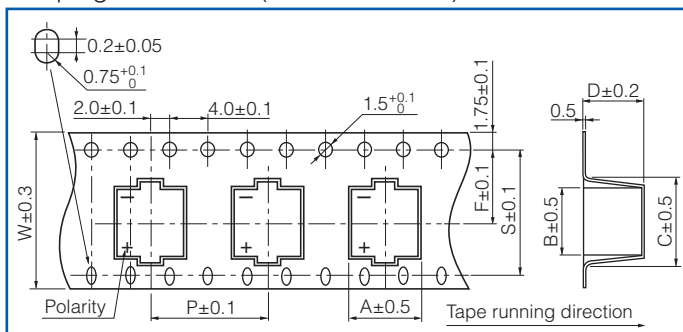

Ask factory for technical specifications.

Size code	Taping size							
	A	B	C	D	F	P	S	W
G13	10.7	10.7	14.5	14.5	14.2	20.0	28.4	32.0
G17	10.7	10.7	14.5	17.5	14.2	20.0	28.4	32.0
H13	14.0	14.0	18.0	14.5	14.2	24.0	28.4	32.0
H16	14.0	14.0	18.0	17.5	14.2	24.0	28.4	32.0
J16	17.5	17.5	23.0	17.5	20.2	28.0	40.4	44.0
J21	17.5	17.5	23.0	22.5	20.2	28.0	40.4	44.0
K16	19.5	19.5	26.0	17.5	20.2	32.0	40.4	44.0
K21	19.5	19.5	26.0	22.5	20.2	32.0	40.4	44.0

Surface Mount Type

Series : **S** Type : **V**

High temperature Lead-Free reflow (suffix : A*)



Features

- Endurance : 85 °C 2000 h
- Vibration-proof product is available upon request. ($\phi 8$ mm and larger)
- RoHS compliant

Specifications

Category temperature range	-40 °C to +85 °C							
Rated voltage range	6.3 V.DC to 50 V.DC							
Capacitance range	1 μ F to 1500 μ F							
Capacitance tolerance	± 20 % (120 Hz/+20 °C)							
Leakage current	$I \leq 0.01$ CV or 3 (μ A) After 2 minutes (Whichever is greater)							
Dissipation factor ($\tan \delta$)	Please see the attached characteristics list							
Characteristics at low temperature	V.DC	6.3	10	16	25	35	50	(Impedance ratio at 120 Hz)
	Z(-25 °C)/Z(+20 °C)	4	3	2	2	2	2	
	Z(-40 °C)/Z(+20 °C)	8	6	4	4	3	3	
Endurance	After applying rated working voltage for 2000 hours (Miniaturization product type 1000 hours) at +85 °C ± 2 °C and then being stabilized at +20 °C, Capacitors shall meet the following limits.							
	Capacitance change	Within ± 20 % of the initial value						
		Size code		Cap. change				
		D8 ($\phi 6.3 \times 7.7$)		2000 hours ± 25 %				
\leq D ($\phi 6.3$) Miniature		1000 hours ± 30 %						
$\tan \delta$	≤ 200 % of the initial limit							
DC leakage current	Within the initial limit							
Shelf life	After storage for 1000 hours at +85 °C ± 2 °C with no voltage applied and then being stabilized at +20 °C, capacitors shall meet the limits specified in Endurance. (With voltage treatment)							
Resistance to soldering heat	After reflow soldering and then being stabilized at +20 °C, capacitors shall meet the following limits.							
	Capacitance change	Within ± 10 % of the initial value						
	$\tan \delta$	Within the initial limit						
DC leakage current	Within the initial limit							
AEC-Q200	AEC-Q200 compliant							

Frequency correction factor for ripple current

Frequency (Hz)	50, 60	120	1 k	10 k to
Correction factor	0.70	1.00	1.30	1.70

Marking

Example : 6.3 V.DC 22 μ F
Marking color : BLACK

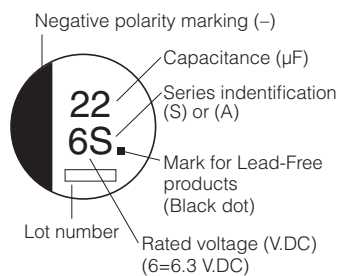

Dimensions

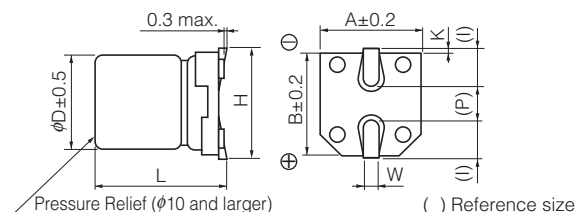

Size code	ϕD	L	A, B	H.	I	W	P	K
B	4.0	$5.4^{+0.1}_{-0.2}$	4.3	5.5 max	1.8	0.65 ± 0.1	1.0	$0.35^{+0.15}_{-0.20}$
C	5.0	$5.4^{+0.1}_{-0.2}$	5.3	6.5 max	2.2	0.65 ± 0.1	1.5	$0.35^{+0.15}_{-0.20}$
D	6.3	$5.4^{+0.1}_{-0.2}$	6.6	7.8 max	2.6	0.65 ± 0.1	1.8	$0.35^{+0.15}_{-0.20}$
D8	6.3	7.7 ± 0.3	6.6	7.8 max	2.6	0.65 ± 0.1	1.8	$0.35^{+0.15}_{-0.20}$
E	8.0	6.2 ± 0.3	8.3	9.5 max	3.4	0.65 ± 0.1	2.2	$0.35^{+0.15}_{-0.20}$
F	8.0	10.2 ± 0.3	8.3	10.0 max	3.4	0.90 ± 0.2	3.1	0.70 ± 0.20
G	10.0	10.2 ± 0.3	10.3	12.0 max	3.5	0.90 ± 0.2	4.6	0.70 ± 0.20

Characteristics list

Rated voltage (V.DC)	Cap. (±20 %) (μF)	Case size (mm)		Size* code	Specification			Part No.	Reflow	Min. Packaging Qty
		φD	L		Ripple current (120 Hz) (+85 °C) (mA r.m.s.)	tan δ (120 Hz) (+20 °C)	Endurance (hours)			Taping (pcs)
6.3	22	4	5.4	B	29	0.30	2000	EEE0JA220AR	(5)	2000
	33	4	5.4	(B)	22	0.35	1000	EEE0JA330WAR	(5)	2000
	47	5	5.4	C	46	0.30	2000	EEE0JA470AR	(5)	1000
	100	5	5.4	(C)	47	0.40	1000	EEE0JA101WAR	(5)	1000
		6.3	5.4	D	71	0.30	2000	EEE0JA101AP	(5)	1000
	330	6.3	7.7	D8	188	0.30	2000	EEE0JA331XAP	(5)	900
		8	6.2	E	300	0.35	2000	EEE0JA331AP	(7)	1000
	470	8	10.2	(F)	380	0.35	1000	EEE0JA471UAP	(7)	500
1000	10	10.2	G	700	0.35	2000	EEE0JA102AP	(7)	500	
1500	10	10.2	(G)	750	0.50	1000	EEE0JA152UAP	(7)	500	
10	22	4	5.4	(B)	28	0.30	1000	EEE1AA220WAR	(5)	2000
	33	4	5.4	(B)	29	0.30	1000	EEE1AA330WAR	(5)	2000
		5	5.4	C	43	0.22	2000	EEE1AA330AR	(5)	1000
	47	5	5.4	(C)	47	0.30	1000	EEE1AA470WAR	(5)	1000
	100	5	5.4	(C)	50	0.30	1000	EEE1AA101WAR	(5)	1000
		6.3	5.4	D	70	0.26	2000	EEE1AA101AP	(5)	1000
	220	6.3	7.7	D8	173	0.22	2000	EEE1AA221XAP	(5)	900
		8	6.2	E	250	0.26	2000	EEE1AA221AP	(7)	1000
	330	8	10.2	F	390	0.26	2000	EEE1AA331AP	(7)	500
	470	8	10.2	(F)	390	0.26	1000	EEE1AA471UAP	(7)	500
10		10.2	G	400	0.26	2000	EEE1AA471AP	(7)	500	
1000	10	10.2	(G)	580	0.35	1000	EEE1AA102UAP	(7)	500	
16	10	4	5.4	B	28	0.16	2000	EEE1CA100AR	(5)	2000
	22	4	5.4	(B)	28	0.26	1000	EEE1CA220WAR	(5)	2000
		5	5.4	C	39	0.16	2000	EEE1CA220AR	(5)	1000
	33	5	5.4	(C)	35	0.26	1000	EEE1CA330WAR	(5)	1000
	47	5	5.4	(C)	39	0.26	1000	EEE1CA470WAR	(5)	1000
		6.3	5.4	D	70	0.16	2000	EEE1CA470AP	(5)	1000
	100	6.3	5.4	(D)	70	0.26	1000	EEE1CA101WAP	(5)	1000
		8	6.2	E	200	0.20	2000	EEE1CA101AP	(7)	1000
	220	6.3	7.7	D8	162	0.20	2000	EEE1CA221XAP	(5)	900
		8	10.2	(F)	280	0.20	1000	EEE1CA221UAP	(7)	500
	330	8	10.2	(F)	320	0.20	1000	EEE1CA331UAP	(7)	500
		10	10.2	G	380	0.20	2000	EEE1CA331AP	(7)	500
	470	8	10.2	(F)	350	0.26	1000	EEE1CA471UAP	(7)	500
		10	10.2	G	420	0.20	2000	EEE1CA471AP	(7)	500
25	4.7	4	5.4	B	22	0.14	2000	EEE1EA4R7AR	(5)	2000
	10	4	5.4	(B)	22	0.20	1000	EEE1EA100WAR	(5)	2000
		5	5.4	C	28	0.14	2000	EEE1EA100AR	(5)	1000
	22	5	5.4	(C)	35	0.20	1000	EEE1EA220WAR	(5)	1000
		6.3	5.4	D	55	0.14	2000	EEE1EA220AP	(5)	1000
	33	5	5.4	(C)	42	0.20	1000	EEE1EA330WAR	(5)	1000
		6.3	5.4	D	65	0.14	2000	EEE1EA330AP	(5)	1000
	47	6.3	5.4	(D)	70	0.20	1000	EEE1EA470WAP	(5)	1000
		8	6.2	(E)	91	0.16	1000	EEE1EA101UAP	(7)	1000
	100	6.3	7.7	D8	143	0.16	2000	EEE1EA101XAP	(5)	900
		8	10.2	F	180	0.16	2000	EEE1EA101AP	(7)	500
	220	8	10.2	(F)	230	0.20	1000	EEE1EA221UAP	(7)	500
		10	10.2	G	310	0.16	2000	EEE1EA221AP	(7)	500
	330	8	10.2	(F)	270	0.20	1000	EEE1EA331UAP	(7)	500
10		10.2	G	340	0.16	2000	EEE1EA331AP	(7)	500	
470	10	10.2	(G)	380	0.25	1000	EEE1EA471UAP	(7)	500	

* Size code() : Miniaturization product

· Please refer to the page of "Reflow Profile" and "The Taping Dimensions".

· When requesting vibration-proof product, please put the last "V" instead to "P"

Characteristics list

Rated voltage (V.DC)	Cap. (±20 %) (μF)	Case size (mm)		Size* code	Specification			Part No.	Reflow	Min. Packaging Qty
		φD	L		Ripple current (120 Hz) (+85 °C) (mA r.m.s.)	tan δ (120 Hz) (+20 °C)	Endurance (hours)			Taping (pcs)
35	4.7	4	5.4	B	22	0.12	2000	EEE1VA4R7AR	(5)	2000
	10	4	5.4	(B)	22	0.16	1000	EEE1VA100WAR	(5)	2000
		5	5.4	C	30	0.12	2000	EEE1VA100AR	(5)	1000
	22	5	5.4	(C)	36	0.16	1000	EEE1VA220WAR	(5)	1000
		6.3	5.4	D	60	0.12	2000	EEE1VA220AP	(5)	1000
	33	6.3	5.4	(D)	60	0.16	1000	EEE1VA330WAP	(5)	1000
		8	6.2	E	130	0.14	2000	EEE1VA330AP	(7)	1000
	47	6.3	5.4	(D)	70	0.16	1000	EEE1VA470WAP	(5)	1000
		8	6.2	E	165	0.14	2000	EEE1VA470AP	(7)	1000
	100	6.3	7.7	D8	132	0.14	2000	EEE1VA101XAP	(5)	900
		8	10.2	(F)	140	0.14	1000	EEE1VA101UAP	(7)	500
		10	10.2	G	210	0.14	2000	EEE1VA101AP	(7)	500
	220	8	10.2	(F)	200	0.14	1000	EEE1VA221UAP	(7)	500
		10	10.2	G	310	0.14	2000	EEE1VA221AP	(7)	500
330	10	10.2	(G)	350	0.30	1000	EEE1VA331UAP	(7)	500	
50	1	4	5.4	B	10	0.12	2000	EEE1HA1R0AR	(5)	2000
	2.2	4	5.4	B	16	0.12	2000	EEE1HA2R2AR	(5)	2000
	3.3	4	5.4	B	16	0.12	2000	EEE1HA3R3AR	(5)	2000
	4.7	4	5.4	(B)	18	0.14	1000	EEE1HA4R7WAR	(5)	2000
		5	5.4	C	23	0.12	2000	EEE1HA4R7AR	(5)	1000
	10	5	5.4	(C)	27	0.14	1000	EEE1HA100WAR	(5)	1000
		6.3	5.4	D	35	0.12	2000	EEE1HA100AP	(5)	1000
	22	6.3	5.4	(D)	40	0.14	1000	EEE1HA220WAP	(5)	1000
		8	6.2	E	120	0.12	2000	EEE1HA220AP	(7)	1000
	33	8	6.2	(E)	65	0.12	1000	EEE1HA330UAP	(7)	1000
		6.3	7.7	D8	65	0.14	2000	EEE1HA330XAP	(5)	900
		8	10.2	F	110	0.12	2000	EEE1HA330AP	(7)	500
	47	6.3	7.7	D8	105	0.14	2000	EEE1HA470XAP	(5)	900
		8	10.2	(F)	110	0.12	1000	EEE1HA470UAP	(7)	500
		10	10.2	G	130	0.12	2000	EEE1HA470AP	(7)	500
	100	8	10.2	(F)	200	0.18	1000	EEE1HA101UAP	(7)	500
		10	10.2	G	250	0.12	2000	EEE1HA101AP	(7)	500
220	10	10.2	(G)	300	0.18	1000	EEE1HA221UAP	(7)	500	

* Size code() : Miniaturization product

· Please refer to the page of "Reflow Profile" and "The Taping Dimensions".

· When requesting vibration-proof product, please put the last "V" instead to "P"



Surface Mount Type

Series: **S** Type: **V**

Features

- Endurance : 85 °C 2000 h
- Vibration-proof product is available upon request. (φ8 mm and larger)
- RoHS compliant

Specifications

Category temp. range	-40 °C to +85 °C										
Rated voltage range	4 V.DC to 100 V.DC										
Capacitance range	1 μF to 1500 μF										
Capacitance tolerance	±20 % (120 Hz/+20°C)										
Leakage cur rent	I ≤ 0.01 CV or 3 (μA) (Bi-Polar I ≤ 0.02 CV or 6 (μA)) After 2 minutes (Whichever is greater)										
Dissipation factor (tan δ)	Please see the attached characteristics list										
Characteristics at low temperature	V.DC	4	6.3	10	16	25	35	50	63	100	(Impedance ratio at 120 Hz)
	Z(-25 °C)/Z(+20 °C)	7	4	3	2	2	2	2	3	3	
	Z(-40 °C)/Z(+20 °C)	15	8	6	4	4	3	3	4	4	
Endurance	After applying rated working voltage for 2000 h (Bi-polar:1000 h for each polarity) at +85 °C±2 °C and then being stabilized at +20 °C, Capacitors shall meet the following limits.										
	Capacitance change	Within ±20 % of the initial value									1000 hours ±30 % 1000 hours ±20 %
		Size code	B(φ4) to D, D8(φ6.3)		Rated voltage		4 V.DC				
		≤ D(φ6.3) Miniature			6.3 V.DC		≥ 10 V.DC				
tan δ	≤200 % of the initial limit										
DC leakage current	Within the initial limit										
Shelf life	After storage for 1000 h at +85 °C±2 °C with no voltage applied and then being stabilized at +20 °C, capacitors shall meet the limits specified in Endurance. (With voltage treatment)										
Resistance to soldering heat	After reflow soldering and then being stabilized at +20 °C, capacitors shall meet the following limits.										
	Capacitance change	Within ±10 % of the initial value									
	tan δ	Within the initial limit									
	DC leakage current	Within the initial limit									
AEC-Q200	AEC-Q200 compliant										

Frequency correction factor for ripple current

Frequency (Hz)	50, 60	120	1 k	10 k to
Correction factor	0.70	1.00	1.30	1.70

Marking

Example : 4 V.DC 33 μF
Marking color : BLACK

Negative polarity marking (-)
(No marking for the bi-polar)

Capacitance (μF)
Series identification (S) or (A)
Mark for Lead-Free products (Black dot)
Lot number
Rated voltage (V.DC)
(6=6.3 V.DC)

Dimensions

() Reference size

Unit : mm

Size code	D	L	A,B	H	I	W	P	K
B	4.0	5.4 ^{+0.1} _{-0.2}	4.3	5.5 max.	1.8	0.65±0.1	1.0	0.35 ^{+0.15} _{-0.20}
C	5.0	5.4 ^{+0.1} _{-0.2}	5.3	6.5 max.	2.2	0.65±0.1	1.5	0.35 ^{+0.15} _{-0.20}
D	6.3	5.4 ^{+0.1} _{-0.2}	6.6	7.8 max.	2.6	0.65±0.1	1.8	0.35 ^{+0.15} _{-0.20}
D8	6.3	7.7±0.3	6.6	7.8 max.	2.6	0.65±0.1	1.8	0.35 ^{+0.15} _{-0.20}
E	8.0	6.2±0.3	8.3	9.5 max.	3.4	0.65±0.1	2.2	0.35 ^{+0.15} _{-0.20}
F	8.0	10.2±0.3	8.3	10.0 max.	3.4	0.90±0.2	3.1	0.70±0.2
G	10.0	10.2±0.3	10.3	12.0 max.	3.5	0.90±0.2	4.6	0.70±0.2

Characteristics list

Rated voltage (V.DC)	Capacitance (±20 %) (μF)	Case size (mm)		Size code *1	Specification			Part number	Reflow	min. Packing Qty
		φD	L		Ripple current *2 (mA r.m.s.)	tan δ *3	Endurance (hours)			Taping (pcs)
4	33	4.0	5.4	B	26	0.35	1000	EEE0GA330SR	(1)	2000
	47	4.0	5.4	B	34	0.35	1000	EEE0GA470SR	(1)	2000
	100	5.0	5.4	C	61	0.35	1000	EEE0GA101SR	(1)	1000
	220	6.3	5.4	D	82	0.35	1000	EEE0GA221SP	(1)	1000
	330	6.3	5.4	(D)	80	0.50	1000	EEE0GA331WP	(1)	1000
	470	6.3	7.7	D8	200	0.35	1000	EEE0GA471XP	(1)	900
6.3	22	4.0	5.4	B	29	0.26	2000	EEE0JA220SR	(1)	2000
	33	4.0	5.4	(B)	22	0.35	1000	EEE0JA330WR	(1)	2000
		4.0	5.4	(B)	36	0.35	1000	EEE0JA470WR	(1)	2000
	47	5.0	5.4	C	46	0.26	2000	EEE0JA470SR	(1)	1000
		5.0	5.4	(C)	47	0.35	1000	EEE0JA101WR	(1)	1000
	100	6.3	5.4	D	71	0.26	2000	EEE0JA101SP	(1)	1000
		6.3	5.4	(D)	74	0.35	1000	EEE0JA221WP	(1)	1000
	330	6.3	7.7	D8	188	0.26	2000	EEE0JA331XP	(1)	900
		8.0	6.2	E	300	0.35	2000	EEE0JA331P	(2)	1000
	470	8.0	10.2	F	380	0.35	2000	EEE0JA471P	(2)	500
	1000	8.0	10.2	(F)	500	0.35	2000	EEE0JA102UP	(2)	500
		10.0	10.2	G	700	0.35	2000	EEE0JA102P	(2)	500
1500	10.0	10.2	G	750	0.35	2000	EEE0JA152P	(2)	500	
10	22	4.0	5.4	(B)	28	0.30	1000	EEE1AA220WR	(1)	2000
	33	4.0	5.4	(B)	29	0.30	1000	EEE1AA330WR	(1)	2000
		5.0	5.4	C	43	0.20	2000	EEE1AA330SR	(1)	1000
	47	5.0	5.4	(C)	43	0.30	1000	EEE1AA470WR	(1)	1000
	100	5.0	5.4	(C)	50	0.30	1000	EEE1AA101WR	(1)	1000
		6.3	5.4	D	70	0.26	2000	EEE1AA101SP	(1)	1000
	220	6.3	7.7	D8	173	0.20	2000	EEE1AA221XP	(1)	900
		8.0	6.2	E	250	0.26	2000	EEE1AA221P	(2)	1000
	330	8.0	10.2	F	390	0.26	2000	EEE1AA331P	(2)	500
	470	8.0	10.2	(F)	390	0.26	2000	EEE1AA471UP	(2)	500
		10.0	10.2	G	400	0.26	2000	EEE1AA471P	(2)	500
	1000	10.0	10.2	G	580	0.26	2000	EEE1AA102P	(2)	500
16	10	4.0	5.4	B	28	0.16	2000	EEE1CA100SR	(1)	2000
	22	4.0	5.4	(B)	28	0.26	1000	EEE1CA220WR	(1)	2000
		5.0	5.4	C	39	0.16	2000	EEE1CA220SR	(1)	1000
	33	5.0	5.4	(C)	35	0.26	1000	EEE1CA330WR	(1)	1000
		5.0	5.4	(C)	39	0.26	1000	EEE1CA470WR	(1)	1000
	47	6.3	5.4	D	70	0.16	2000	EEE1CA470SP	(1)	1000
		6.3	5.4	(D)	70	0.26	1000	EEE1CA101WP	(1)	1000
	100	8.0	6.2	E	200	0.20	2000	EEE1CA101P	(2)	1000
		6.3	7.7	D8	162	0.16	2000	EEE1CA221XP	(1)	900
	220	8.0	6.2	E	200	0.20	2000	EEE1CA221UP	(2)	1000
		8.0	10.2	F	280	0.20	2000	EEE1CA221P	(2)	500
	330	8.0	10.2	(F)	320	0.20	2000	EEE1CA331UP	(2)	500
		10.0	10.2	G	380	0.20	2000	EEE1CA331P	(2)	500
	470	8.0	10.2	(F)	350	0.20	2000	EEE1CA471UP	(2)	500
		10.0	10.2	G	420	0.20	2000	EEE1CA471P	(2)	500

*1: Size code () : Miniaturization product

*2: Ripple current (120 Hz / +85 °C)

*3: tan δ (120 Hz / +20 °C)

• Please refer to the page of "Reflow Profile" and "The Taping Dimensions".

• When requesting vibration-proof product, please put the last "V" instead to "P"

Characteristics list

Rated voltage (V.DC)	Capacitance (±20 %) (μF)	Case size (mm)		Size code *1	Specification			Part number	Reflow	min. Packing Qty
		φD	L		Ripple current *2 (mA r.m.s.)	tan δ *3	Endurance (hours)			Taping (pcs)
25	4.7	4.0	5.4	B	22	0.14	2000	EEE1EA4R7SR	(1)	2000
	10	4.0	5.4	(B)	22	0.20	1000	EEE1EA100WR	(1)	2000
		5.0	5.4	C	28	0.14	2000	EEE1EA100SR	(1)	1000
	22	5.0	5.4	(C)	35	0.20	1000	EEE1EA220WR	(1)	1000
		6.3	5.4	D	55	0.14	2000	EEE1EA220SP	(1)	1000
	33	5.0	5.4	(C)	42	0.20	1000	EEE1EA330WR	(1)	1000
		6.3	5.4	D	65	0.14	2000	EEE1EA330SP	(1)	1000
	47	6.3	5.4	(D)	70	0.20	1000	EEE1EA470WP	(1)	1000
	100	6.3	7.7	D8	143	0.14	2000	EEE1EA101XP	(1)	900
		8.0	6.2	(E)	91	0.16	2000	EEE1EA101UP	(2)	1000
		8.0	10.2	F	180	0.16	2000	EEE1EA101P	(2)	500
	220	8.0	10.2	(F)	230	0.16	2000	EEE1EA221UP	(2)	500
		10.0	10.2	G	310	0.16	2000	EEE1EA221P	(2)	500
	330	8.0	10.2	(F)	270	0.16	2000	EEE1EA331UP	(2)	500
		10.0	10.2	G	340	0.16	2000	EEE1EA331P	(2)	500
470	10.0	10.2	G	380	0.16	2000	EEE1EA471P	(2)	500	
35	4.7	4.0	5.4	B	22	0.12	2000	EEE1VA4R7SR	(1)	2000
	10	4.0	5.4	(B)	22	0.16	1000	EEE1VA100WR	(1)	2000
		5.0	5.4	C	30	0.12	2000	EEE1VA100SR	(1)	1000
	22	5.0	5.4	(C)	36	0.16	1000	EEE1VA220WR	(1)	1000
		6.3	5.4	D	60	0.12	2000	EEE1VA220SP	(1)	1000
	33	6.3	5.4	(D)	60	0.16	1000	EEE1VA330WP	(1)	1000
		8.0	6.2	E	130	0.14	2000	EEE1VA330P	(2)	1000
	47	6.3	5.4	(D)	70	0.16	1000	EEE1VA470WP	(1)	1000
		8.0	6.2	E	165	0.14	2000	EEE1VA470P	(2)	1000
	100	6.3	7.7	D8	132	0.12	2000	EEE1VA101XP	(1)	900
		8.0	10.2	(F)	140	0.14	2000	EEE1VA101UP	(2)	500
		10.0	10.2	G	210	0.14	2000	EEE1VA101P	(2)	500
	220	8.0	10.2	(F)	200	0.14	2000	EEE1VA221UP	(2)	500
		10.0	10.2	G	310	0.14	2000	EEE1VA221P	(2)	500
	330	10.0	10.2	G	350	0.14	2000	EEE1VA331P	(2)	500

*1: Size code () : Miniaturization product

*2: Ripple current (120 Hz / +85 °C)

*3: tanδ (120 Hz / +20 °C)

• Please refer to the page of "Reflow Profile" and "The Taping Dimensions".

• When requesting vibration-proof product, please put the last "V" instead to "P"

Characteristics list

Rated voltage (V.DC)	Capacitance (±20 %) (μF)	Case size (mm)		Size code *1	Specification			Part number	Reflow	min. Packing Qty
		φD	L		Ripple current *2 (mA r.m.s.)	tan δ *3	Endurance (hours)			Taping (pcs)
50	1.0	4.0	5.4	B	10	0.12	2000	EEE1HA010SR	(1)	2000
	2.2	4.0	5.4	B	16	0.12	2000	EEE1HA2R2SR	(1)	2000
	3.3	4.0	5.4	B	16	0.12	2000	EEE1HA3R3SR	(1)	2000
	4.7	4.0	5.4	(B)	18	0.14	1000	EEE1HA4R7WR	(1)	2000
		5.0	5.4	C	23	0.12	2000	EEE1HA4R7SR	(1)	1000
	10	5.0	5.4	(C)	27	0.14	1000	EEE1HA100WR	(1)	1000
		6.3	5.4	D	35	0.12	2000	EEE1HA100SP	(1)	1000
	22	6.3	5.4	(D)	40	0.14	1000	EEE1HA220WP	(1)	1000
		8.0	6.2	E	120	0.12	2000	EEE1HA220P	(2)	1000
	33	6.3	7.7	D8	85	0.12	2000	EEE1HA330XP	(1)	900
		8.0	6.2	(E)	65	0.12	2000	EEE1HA330UP	(2)	1000
		8.0	10.2	F	110	0.12	2000	EEE1HA330P	(2)	500
	47	6.3	7.7	D8	105	0.12	2000	EEE1HA470XP	(1)	900
		8.0	10.2	(F)	110	0.12	2000	EEE1HA470UP	(2)	500
		10.0	10.2	G	130	0.12	2000	EEE1HA470P	(2)	500
100	8.0	10.2	(F)	200	0.12	2000	EEE1HA101UP	(2)	500	
	10.0	10.2	G	250	0.12	2000	EEE1HA101P	(2)	500	
220	10.0	10.2	G	300	0.12	2000	EEE1HA221P	(2)	500	
63	22	8.0	6.2	(E)	40	0.18	2000	EEE1JA220UP	(2)	1000
		8.0	10.2	F	40	0.18	2000	EEE1JA220P	(2)	500
	33	8.0	10.2	F	45	0.18	2000	EEE1JA330P	(2)	500
	47	8.0	10.2	(F)	45	0.18	2000	EEE1JA470UP	(2)	500
		10.0	10.2	G	45	0.18	2000	EEE1JA470P	(2)	500
100	10.0	10.2	G	60	0.18	2000	EEE1JA101P	(2)	500	
100	4.7	8.0	6.2	(E)	50	0.18	2000	EEE2AA4R7UP	(2)	1000
	10	8.0	6.2	(E)	50	0.18	2000	EEE2AA100UP	(2)	1000
		8.0	10.2	F	85	0.18	2000	EEE2AA100P	(2)	500
	22	8.0	10.2	(F)	55	0.18	2000	EEE2AA220UP	(2)	500
		10.0	10.2	G	85	0.18	2000	EEE2AA220P	(2)	500
33	10.0	10.2	G	90	0.18	2000	EEE2AA330P	(2)	500	

*1: Size code () : Miniaturization product

*2: Ripple current (120 Hz / +85 °C)

*3: tanδ (120 Hz / +20 °C)

- Please refer to the page of "Reflow Profile" and "The Taping Dimensions".
- When requesting vibration-proof product, please put the last "V" instead to "P"

Characteristics list

Rated voltage (V.DC)	Capacitance ($\pm 20\%$) (μF)	Case size (mm)		Size code	Specification		Part number	Reflow	Min. Packing Qty
		ϕD	L		Ripple current *1 (mA r.m.s.)	$\tan \delta$ *2			Taping (pcs)
6.3	22	5.0	5.4	C	29	0.52	EEE0JA220NR	(1)	1000
	47	6.3	5.4	D	46	0.52	EEE0JA470NP	(1)	1000
10	10	4.0	5.4	B	25	0.40	EEE1AA100NR	(1)	2000
	33	6.3	5.4	D	43	0.40	EEE1AA330NP	(1)	1000
16	4.7	4.0	5.4	B	20	0.32	EEE1CA4R7NR	(1)	2000
	10	5.0	5.4	C	25	0.32	EEE1CA100NR	(1)	1000
	22	6.3	5.4	D	39	0.32	EEE1CA220NP	(1)	1000
25	3.3	4.0	5.4	B	12	0.28	EEE1EA3R3NR	(1)	2000
	4.7	5.0	5.4	C	21	0.28	EEE1EA4R7NR	(1)	1000
	10	6.3	5.4	D	28	0.28	EEE1EA100NP	(1)	1000
35	2.2	4.0	5.4	B	12	0.24	EEE1VA2R2NR	(1)	2000
	4.7	5.0	5.4	C	22	0.24	EEE1VA4R7NR	(1)	1000
	10	6.3	5.4	D	30	0.24	EEE1VA100NP	(1)	1000
50	1.0	4.0	5.4	B	10	0.24	EEE1HA010NR	(1)	2000
	2.2	5.0	5.4	C	16	0.24	EEE1HA2R2NR	(1)	1000
	3.3	5.0	5.4	C	21	0.24	EEENZ1H3R3R	(1)	1000
	4.7	6.3	5.4	D	31	0.24	EEE1HA4R7NP	(1)	1000

*1: Ripple current (120 Hz / +85 °C)

*2: $\tan \delta$ (120 Hz / +20 °C)

- Please refer to the page of "Reflow Profile" and "The Taping Dimensions".
- When requesting vibration-proof product, please put the last "V" instead to "P"

Surface Mount Type

Series : **HA** Type : **V**
High temperature
Lead-Free reflow (suffix : A*)

High-temperature assurance size

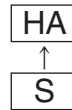

Features

- Endurance : 105 °C 1000 h
- Vibration-proof product is available upon request. (φ8 mm and larger)
- RoHS compliant

Specifications

Category temperature range	-40 °C to +105 °C							
Rated voltage range	6.3 V.DC to 50 V.DC							
Capacitance range	1 μF to 1500 μF							
Capacitance tolerance	±20 % (120 Hz/+20 °C)							
Leakage current	I ≤ 0.01 CV or 3 (μA) After 2 minutes (Whichever is greater)							
Dissipation factor (tan δ)	Please see the attached characteristics list							
Characteristics at low temperature	V.DC	6.3	10	16	25	35	50	(Impedance ratio at 120 Hz)
	Z(-25 °C)/Z(+20 °C)	4	3	2	2	2	2	
	Z(-40 °C)/Z(+20 °C)	8	6	4	4	3	3	
Endurance	After applying rated working voltage for 1000 hours at +105 °C±2 °C and then being stabilized at +20 °C, capacitors shall meet the following limits.							
	Capacitance change	Within ±30 % of the initial value						
	tan δ	≤200 % of the initial limit						
	DC leakage current	Within the initial limit						
Shelf life	After storage for 1000 hours at +105 °C±2 °C with no voltage applied and then being stabilized at +20 °C, capacitors shall meet the limits specified in Endurance. (With voltage treatment)							
Resistance to soldering heat	After reflow soldering and then being stabilized at +20 °C, capacitors shall meet the following limits.							
	Capacitance change	Within ±10 % of the initial value						
	tan δ	Within the initial limit						
	DC leakage current	Within the initial limit						
AEC-Q200	AEC-Q200 compliant							

Frequency correction factor for ripple current

Frequency (Hz)	50, 60	120	1 k	10 k to
Correction factor	0.70	1.00	1.30	1.70

Marking

Example : 6.3 V.DC 22 μF
 Marking color : BLACK

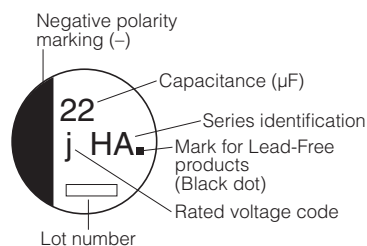

R. Voltage (V.DC)	6.3	10	16	25	35	50
Code	j	A	C	E	V	H

Dimensions

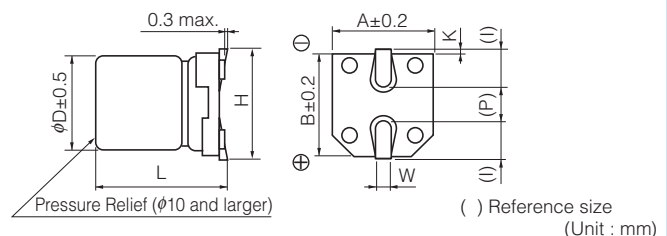

Size code	φD	L	A, B	H	I	W	P	K
B	4.0	5.4 ^{+0.1} _{-0.2}	4.3	5.5 max.	1.8	0.65±0.1	1.0	0.35 ^{+0.15} _{-0.20}
C	5.0	5.4 ^{+0.1} _{-0.2}	5.3	6.5 max.	2.2	0.65±0.1	1.5	0.35 ^{+0.15} _{-0.20}
D	6.3	5.4 ^{+0.1} _{-0.2}	6.6	7.8 max.	2.6	0.65±0.1	1.8	0.35 ^{+0.15} _{-0.20}
D8	6.3	7.7±0.3	6.6	7.8 max.	2.6	0.65±0.1	1.8	0.35 ^{+0.15} _{-0.20}
E	8.0	6.2±0.3	8.3	9.5 max.	3.4	0.65±0.1	2.2	0.35 ^{+0.15} _{-0.20}
F	8.0	10.2±0.3	8.3	10.0 max.	3.4	0.90±0.2	3.1	0.70±0.20
G	10.0	10.2±0.3	10.3	12.0 max.	3.5	0.90±0.2	4.6	0.70±0.20

Characteristics list

Endurance : 105 °C 1000 h

Rated voltage (V.DC)	Cap. (±20 %) (μF)	Case size (mm)		Size* code	Specification		Part No.	Reflow	Min. Packaging Q'ty
		φD	L		Ripple current (120 Hz) (+105 °C) (mA r.m.s.)	tan δ (120 Hz) (+20 °C)			Taping (pcs)
6.3	22	4	5.4	B	29	0.30	EEEHA0J220AR	(5)	2000
	33	4	5.4	(B)	29	0.35	EEEHAJ330WAR	(5)	2000
	47	5	5.4	C	46	0.30	EEEHA0J470AR	(5)	1000
	100	5	5.4	(C)	47	0.40	EEEHAJ101WAR	(5)	1000
		6.3	5.4	D	71	0.30	EEEHA0J101AP	(5)	1000
	330	6.3	7.7	D8	105	0.30	EEEHAJ331XAP	(5)	900
		8	6.2	(E)	180	0.35	EEEHAJ331UAP	(7)	500
		8	10.2	F	230	0.35	EEEHA0J331AP	(7)	500
	470	8	10.2	(F)	300	0.35	EEEHAJ471UAP	(7)	500
1000	10	10.2	G	400	0.35	EEEHA0J102AP	(7)	500	
1500	10	10.2	(G)	480	0.50	EEEHAJ152UAP	(7)	500	
10	22	4	5.4	(B)	28	0.30	EEEHAA220WAR	(5)	2000
	33	4	5.4	(B)	29	0.30	EEEHAA330WAR	(5)	2000
		5	5.4	C	43	0.22	EEEHA1A330AR	(5)	1000
	47	5	5.4	(C)	43	0.30	EEEHAA470WAR	(5)	1000
	100	6.3	5.4	(D)	71	0.30	EEEHAA101WAP	(5)	1000
		8	6.2	E	110	0.26	EEEHA1A101AP	(7)	1000
	220	6.3	7.7	D8	105	0.22	EEEHAA221XAP	(5)	900
		8	10.2	F	160	0.26	EEEHA1A221AP	(7)	500
	470	8	10.2	(F)	200	0.26	EEEHAA471UAP	(7)	500
10		10.2	G	270	0.26	EEEHA1A471AP	(7)	500	
1000	10	10.2	(G)	400	0.35	EEEHAA102UAP	(7)	500	
16	10	4	5.4	B	28	0.16	EEEHA1C100AR	(5)	2000
	22	4	5.4	(B)	28	0.26	EEEHAC220WAR	(5)	2000
		5	5.4	C	39	0.16	EEEHA1C220AR	(5)	1000
	33	5	5.4	(C)	35	0.26	EEEHAC330WAR	(5)	1000
	47	5	5.4	(C)	39	0.26	EEEHAC470WAR	(5)	1000
		6.3	5.4	D	70	0.16	EEEHA1C470AP	(5)	1000
	100	6.3	5.4	(D)	70	0.26	EEEHAC101WAP	(5)	1000
	220	6.3	7.7	D8	105	0.20	EEEHAC221XAP	(5)	900
		8	10.2	(F)	150	0.20	EEEHAC221UAP	(7)	500
		10	10.2	G	210	0.20	EEEHA1C221AP	(7)	500
	330	8	10.2	(F)	170	0.20	EEEHAC331UAP	(7)	500
		10	10.2	G	230	0.20	EEEHA1C331AP	(7)	500
	470	8	10.2	(F)	340	0.26	EEEHAC471UAP	(7)	500
10		10.2	G	340	0.20	EEEHA1C471AP	(7)	500	
680	10	10.2	(G)	380	0.26	EEEHAC681UAP	(7)	500	

* Size code() : Miniaturization product

If Part number exceeds 12 digits, voltage code is abbreviated as follows; 0J → J, 1A → A, 1C → C, 1E → E, 1V → V, 1H → H

· Please refer to the page of "Reflow Profile" and "The Taping Dimensions".

· When requesting vibration-proof product, please put the last "V" instead to "P"

Characteristics list

Endurance : 105 °C 1000 h

Rated voltage (V.DC)	Cap. (±20 %) (μF)	Case size (mm)		Size* code	Specification		Part No.	Reflow	Min. Packaging Q'ty
		φD	L		Ripple current (120 Hz) (+105 °C) (mA r.m.s.)	tan δ (120 Hz) (+20 °C)			Taping (pcs)
25	4.7	4	5.4	B	22	0.14	EEEHA1E4R7AR	(5)	2000
	10	4	5.4	(B)	22	0.20	EEEHAE100WAR	(5)	2000
		5	5.4	C	28	0.14	EEEHA1E100AR	(5)	1000
	22	5	5.4	(C)	35	0.20	EEEHAE220WAR	(5)	1000
		6.3	5.4	D	55	0.14	EEEHA1E220AP	(5)	1000
	33	5	5.4	(C)	45	0.20	EEEHAE330WAR	(5)	1000
		6.3	5.4	D	65	0.14	EEEHA1E330AP	(5)	1000
	47	6.3	5.4	(D)	70	0.20	EEEHAE470WAP	(5)	1000
		8	6.2	E	91	0.16	EEEHA1E470AP	(7)	1000
	100	8	6.2	(E)	91	0.16	EEEHAE101UAP	(7)	1000
		6.3	7.7	D8	91	0.16	EEEHAE101XAP	(5)	900
	220	8	10.2	F	130	0.16	EEEHA1E101AP	(7)	500
		10	10.2	G	160	0.20	EEEHAE221UAP	(7)	500
	330	8	10.2	(F)	180	0.20	EEEHAE331UAP	(7)	500
10		10.2	G	340	0.16	EEEHA1E331AP	(7)	500	
470	10	10.2	(G)	360	0.25	EEEHAE471UAP	(7)	500	
35	4.7	4	5.4	B	22	0.12	EEEHA1V4R7AR	(5)	2000
	10	4	5.4	(B)	22	0.16	EEEHAV100WAR	(5)	2000
		5	5.4	C	30	0.12	EEEHA1V100AR	(5)	1000
	22	5	5.4	(C)	35	0.16	EEEHAV220WAR	(5)	1000
		6.3	5.4	D	60	0.12	EEEHA1V220AP	(5)	1000
	33	6.3	5.4	(D)	42	0.16	EEEHAV330WAP	(5)	1000
		8	6.2	E	84	0.14	EEEHA1V330AP	(7)	1000
	47	8	6.2	(E)	84	0.14	EEEHAV470UAP	(7)	1000
		8	10.2	F	98	0.14	EEEHA1V470AP	(7)	500
	100	6.3	7.7	D8	84	0.14	EEEHAV101XAP	(5)	900
		8	10.2	(F)	120	0.14	EEEHAV101UAP	(7)	500
	220	10	10.2	G	160	0.14	EEEHA1V101AP	(7)	500
		8	10.2	(F)	170	0.14	EEEHAV221UAP	(7)	500
	330	10	10.2	G	210	0.14	EEEHA1V221AP	(7)	500
10		10.2	(G)	250	0.30	EEEHAV331UAP	(7)	500	
50	1	4	5.4	B	10	0.12	EEEHA1H1R0AR	(5)	2000
	2.2	4	5.4	B	16	0.12	EEEHA1H2R2AR	(5)	2000
	3.3	4	5.4	B	16	0.12	EEEHA1H3R3AR	(5)	2000
	4.7	5	5.4	C	23	0.12	EEEHA1H4R7AR	(5)	1000
	10	6.3	5.4	D	35	0.12	EEEHA1H100AP	(5)	1000
	22	8	6.2	E	70	0.12	EEEHA1H220AP	(7)	1000
		6.3	7.7	D8	70	0.14	EEEHAH330XAP	(5)	900
	33	8	6.2	(E)	70	0.12	EEEHAH330UAP	(7)	1000
		8	10.2	F	91	0.12	EEEHA1H330AP	(7)	500
	47	6.3	7.7	D8	63	0.14	EEEHAH470XAP	(5)	900
		8	10.2	(F)	95	0.12	EEEHAH470UAP	(7)	500
	100	10	10.2	G	100	0.12	EEEHA1H470AP	(7)	500
		8	10.2	(F)	110	0.18	EEEHAH101UAP	(7)	500
	220	10	10.2	G	120	0.12	EEEHA1H101AP	(7)	500
10		10.2	(G)	150	0.18	EEEHAH221UAP	(7)	500	

* Size code() : Miniaturization product

If Part number exceeds 12 digits, voltage code is abbreviated as follows; 0J → J, 1A → A, 1C → C, 1E → E, 1V → V, 1H → H

· Please refer to the page of "Reflow Profile" and "The Taping Dimensions".

· When requesting vibration-proof product, please put the last "V" instead to "P"

Surface Mount Type

Series: **HA** Type: **V**

High-temperature assurance



Features

- Endurance : 105 °C 1000 h
- Vibration-proof product is available upon request. (φ8 mm and larger)
- RoHS compliant

Specifications

Category temp. range	-40 °C to +105 °C									
Rated voltage range	6.3 V.DC to 100 V.DC									
Capacitance range	1 μF to 1500 μF									
Capacitance tolerance	±20 % (120 Hz/+20°C)									
Leakage current	$I \leq 0.01 CV$ or 3 (μA) After 2 minutes (Whichever is greater)									
Dissipation factor (tan δ)	Please see the attached characteristics list									
Characteristics at low temperature	V.DC	6.3	10	16	25	35	50	63	100	(Impedance ratio at 120 Hz)
	Z(-25 °C)/Z(+20 °C)	4	3	2	2	2	2	3	3	
	Z(-40 °C)/Z(+20 °C)	8	6	4	4	3	3	4	4	
Endurance	After applying rated working voltage for 1000 hours at +105 °C±2 °C and then being stabilized at +20 °C, Capacitors shall meet the following limits.									
	Capacitance change	Within ±20 % of the initial value (6.3 V.DC of miniature : ±30 %)								
	tan δ	≤ 200 % of the initial limit								
Shelf life	After storage for 1000 hours at +85 °C±2 °C with no voltage applied and then being stabilized at +20 °C, capacitors shall meet the limits specified in Endurance. (With voltage treatment)									
	After reflow soldering and then being stabilized at +20 °C, capacitors shall meet the following limits.									
	DC leakage current	Within the initial limit								
Resistance to soldering heat	After reflow soldering and then being stabilized at +20 °C, capacitors shall meet the following limits.									
	Capacitance change	Within ±10 % of the initial value								
	tan δ	Within the initial limit								
	DC leakage current	Within the initial limit								

Frequency correction factor for ripple current

Frequency (Hz)	50, 60	120	1 k	10 k to
Correction factor	0.70	1.00	1.30	1.70

Marking

Example : 6.3 V.DC 22 μF
Marking color : BLACK

Negative polarity marking (-)

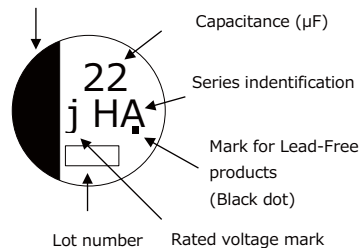

Rated voltage mark		Unit : V.DC	
j	6.3	V	35
A	10	H	50
C	16	J	63
E	25	2A	100

Dimensions

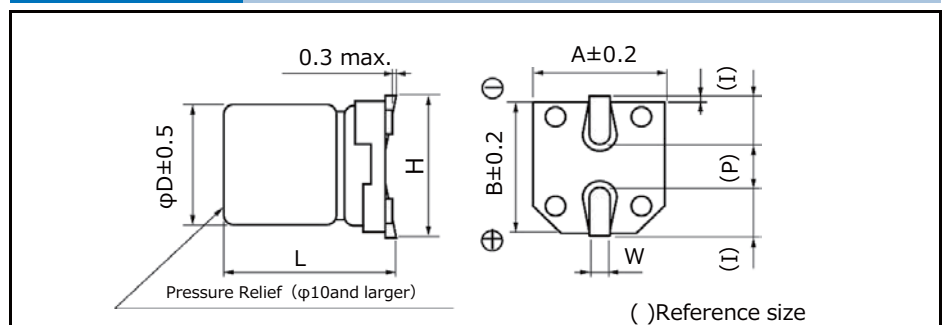

Size code	D	L	A,B	H	I	W	P	K
B	4.0	5.4 ^{+0.1} _{-0.2}	4.3	5.5 max.	1.8	0.65±0.1	1.0	0.35 ^{+0.15} _{-0.20}
C	5.0	5.4 ^{+0.1} _{-0.2}	5.3	6.5 max.	2.2	0.65±0.1	1.5	0.35 ^{+0.15} _{-0.20}
D	6.3	5.4 ^{+0.1} _{-0.2}	6.6	7.8 max.	2.6	0.65±0.1	1.8	0.35 ^{+0.15} _{-0.20}
D8	6.3	7.7±0.3	6.6	7.8 max.	2.6	0.65±0.1	1.8	0.35 ^{+0.15} _{-0.20}
E	8.0	6.2±0.3	8.3	9.5 max.	3.4	0.65±0.1	2.2	0.35 ^{+0.15} _{-0.20}
F	8.0	10.2±0.3	8.3	10.0 max.	3.4	0.90±0.2	3.1	0.70±0.2
G	10.0	10.2±0.3	10.3	12.0 max.	3.5	0.90±0.2	4.6	0.70±0.2

Characteristics list

Endurance : 105 °C 1000 h

Rated voltage (V.DC)	Capacitance (±20 %) (μF)	Case size(mm)		Size code *1	Specification		Part number	Reflow	Packaging Qty Taping (pcs)
		φD	L		Ripple current *2 (mA r.m.s.)	tan δ *3			
6.3	22	4	5.4	B	29	0.30	EEEHA0J220R	(1)	2000
	33	4	5.4	(B)	29	0.35	EEEHA0J330WR	(1)	2000
	47	4	5.4	(B)	36	0.35	EEEHA0J470WR	(1)	2000
			5	C	46	0.30	EEEHA0J470R	(1)	1000
	100	5	5.4	(C)	47	0.35	EEEHA0J101WR	(1)	1000
			6.3	D	71	0.30	EEEHA0J101P	(1)	1000
	220	6.3	5.4	(D)	74	0.35	EEEHA0J221WP	(1)	1000
	330	6.3	7.7	D8	105	0.30	EEEHA0J331XP	(1)	900
			8	F	230	0.35	EEEHA0J331P	(2)	500
	470	8	10.2	(F)	300	0.35	EEEHA0J471UP	(2)	500
1000	8	10.2	(F)	300	0.35	EEEHA0J102UP	(2)	500	
		10	G	400	0.35	EEEHA0J102P	(2)	500	
1500	10	10.2	G	480	0.35	EEEHA0J152P	(2)	500	
10	22	4	5.4	(B)	28	0.30	EEEHA1A220WR	(1)	2000
	33	4	5.4	(B)	29	0.30	EEEHA1A330WR	(1)	2000
			5	C	43	0.22	EEEHA1A330R	(1)	1000
	47	5	5.4	(C)	43	0.30	EEEHA1A470WR	(1)	1000
	100	6.3	5.4	(D)	71	0.30	EEEHA1A101WP	(1)	1000
			8	E	110	0.26	EEEHA1A101P	(2)	1000
	220	6.3	7.7	D8	105	0.22	EEEHA1A221XP	(1)	900
			8	F	160	0.26	EEEHA1A221P	(2)	500
	470	8	10.2	(F)	200	0.26	EEEHA1A471UP	(2)	500
			10	G	270	0.26	EEEHA1A471P	(2)	500
1000	10	10.2	G	400	0.26	EEEHA1A102P	(2)	500	
16	10	4	5.4	B	28	0.16	EEEHA1C100R	(1)	2000
	22	4	5.4	(B)	28	0.26	EEEHA1C220WR	(1)	2000
			5	C	39	0.16	EEEHA1C220R	(1)	1000
	33	5	5.4	(C)	35	0.26	EEEHA1C330WR	(1)	1000
	47	5	5.4	(C)	39	0.26	EEEHA1C470WR	(1)	1000
			6.3	D	70	0.16	EEEHA1C470P	(1)	1000
	100	6.3	5.4	(D)	70	0.26	EEEHA1C101WP	(1)	1000
			8.0	E	91	0.20	EEEHA1C101UP	(2)	1000
	220	6.3	7.7	D8	105	0.16	EEEHA1C221XP	(1)	900
			8	(F)	150	0.20	EEEHA1C221UP	(2)	500
			10	G	210	0.20	EEEHA1C221P	(2)	500
	330	8	10.2	(F)	170	0.20	EEEHA1C331UP	(2)	500
			10	G	230	0.20	EEEHA1C331P	(2)	500
	470	8	10.2	(F)	340	0.20	EEEHA1C471UP	(2)	500
			10	G	340	0.20	EEEHA1C471P	(2)	500
	680	10	10.2	G	380	0.20	EEEHA1C681P	(2)	500

*1: Size code () : Miniaturization product

*2: Ripple current (120 Hz / +105 °C)

*3: tanδ (120 Hz / +20 °C)

- Please refer to the page of "Reflow Profile" and "The Taping Dimensions".
- When requesting vibration-proof product, please put the last "V" instead to "P"

Characteristics list

Endurance : 105 °C 1000 h

Rated voltage (V.DC)	Capacitance (±20 %) (μF)	Case size(mm)		Size code *1	Specification		Part number	Reflow	Taping (pcs)
		φD	L		Ripple current *2 (mA r.m.s.)	tan δ *3			
25	4.7	4	5.4	B	22	0.14	EEEHA1E4R7R	(1)	2000
	10	4	5.4	(B)	22	0.20	EEEHA1E100WR	(1)	2000
		5	5.4	C	28	0.14	EEEHA1E100R	(1)	1000
	22	5	5.4	(C)	35	0.20	EEEHA1E220WR	(1)	1000
		6.3	5.4	D	55	0.14	EEEHA1E220P	(1)	1000
	33	5	5.4	(C)	45	0.20	EEEHA1E330WR	(1)	1000
		6.3	5.4	D	65	0.14	EEEHA1E330P	(1)	1000
	47	6.3	5.4	(D)	70	0.20	EEEHA1E470WP	(1)	1000
		8	6.2	E	91	0.16	EEEHA1E470P	(2)	1000
	100	6.3	7.7	D8	91	0.14	EEEHA1E101XP	(1)	900
		8	6.2	(E)	91	0.16	EEEHA1E101UP	(2)	1000
		8	10.2	F	130	0.16	EEEHA1E101P	(2)	500
220	8	10.2	(F)	160	0.16	EEEHA1E221UP	(2)	500	
	10	10.2	G	190	0.16	EEEHA1E221P	(2)	500	
330	8	10.2	(F)	180	0.16	EEEHA1E331UP	(2)	500	
	10	10.2	G	340	0.16	EEEHA1E331P	(2)	500	
470	10	10.2	G	360	0.16	EEEHA1E471P	(2)	500	
35	4.7	4	5.4	B	22	0.12	EEEHA1V4R7R	(1)	2000
	10	4	5.4	(B)	22	0.16	EEEHA1V100WR	(1)	2000
		5	5.4	C	30	0.12	EEEHA1V100R	(1)	1000
	22	5	5.4	(C)	35	0.16	EEEHA1V220WR	(1)	1000
		6.3	5.4	D	60	0.12	EEEHA1V220P	(1)	1000
	33	6.3	5.4	(D)	42	0.16	EEEHA1V330WP	(1)	1000
		8	6.2	E	84	0.14	EEEHA1V330P	(2)	1000
	47	8	6.2	(E)	84	0.14	EEEHA1V470UP	(2)	1000
		8	10.2	F	98	0.14	EEEHA1V470P	(2)	500
	100	6.3	7.7	D8	84	0.12	EEEHA1V101XP	(1)	900
		8	10.2	(F)	120	0.14	EEEHA1V101UP	(2)	500
		10	10.2	G	160	0.14	EEEHA1V101P	(2)	500
220	8	10.2	(F)	170	0.14	EEEHA1V221UP	(2)	500	
	10	10.2	G	210	0.14	EEEHA1V221P	(2)	500	
330	10	10.2	G	250	0.14	EEEHA1V331P	(2)	500	
50	1.0	4	5.4	B	10	0.12	EEEHA1H1R0R	(1)	2000
	2.2	4	5.4	B	16	0.12	EEEHA1H2R2R	(1)	2000
	3.3	4	5.4	B	16	0.12	EEEHA1H3R3R	(1)	2000
	4.7	5	5.4	C	23	0.12	EEEHA1H4R7R	(1)	1000
	10	6.3	5.4	D	35	0.12	EEEHA1H100P	(1)	1000
	22	8	6.2	E	70	0.12	EEEHA1H220P	(2)	1000
		6.3	7.7	D8	70	0.12	EEEHA1H330XP	(1)	900
	33	8	6.2	(E)	70	0.12	EEEHA1H330UP	(2)	1000
		8	10.2	F	91	0.12	EEEHA1H330P	(2)	500
	47	6.3	7.7	D8	63	0.12	EEEHA1H470XP	(1)	900
		8	10.2	(F)	95	0.12	EEEHA1H470UP	(2)	500
		10	10.2	G	100	0.12	EEEHA1H470P	(2)	500
100	8	10.2	(F)	110	0.12	EEEHA1H101UP	(2)	500	
	10	10.2	G	120	0.12	EEEHA1H101P	(2)	500	
220	10	10.2	G	150	0.12	EEEHA1H221P	(2)	500	

*1: Size code () : Miniaturization product

*2: Ripple current (120 Hz / +105 °C)

*3: tanδ (120 Hz / +20 °C)

- Please refer to the page of "Reflow Profile" and "The Taping Dimensions".
- When requesting vibration-proof product, please put the last "V" instead to "P"

Characteristics list

Endurance : 105 °C 1000 h

Rated voltage (V.DC)	Capacitance (±20 %) (μF)	Case size(mm)		Size code *1	Specification		Part number	Reflow	Packaging Qty
		φD	L		Ripple current *2 (mA r.m.s.)	tan δ *3			
63	10	8	6.2	E	25	0.18	EEEHA1J100P	(2)	1000
	22	8	6.2	(E)	25	0.18	EEEHA1J220UP	(2)	1000
		8	10.2	F	30	0.18	EEEHA1J220P	(2)	500
	33	10	10.2	G	45	0.18	EEEHA1J330P	(2)	500
	47	8	10.2	(F)	45	0.18	EEEHA1J470UP	(2)	500
		10	10.2	G	50	0.18	EEEHA1J470P	(2)	500
100	4.7	8	6.2	(E)	30	0.18	EEEHA2A4R7UP	(2)	1000
	10	8	10.2	F	55	0.18	EEEHA2A100P	(2)	500
	22	8	10.2	(F)	55	0.18	EEEHA2A220UP	(2)	500
		10	10.2	G	60	0.18	EEEHA2A220P	(2)	500
	33	10	10.2	G	65	0.18	EEEHA2A330P	(2)	500
	47	10	10.2	(G)	65	0.18	EEEHA2A470UP	(2)	500

*1: Size code () : Miniaturization product

*2: Ripple current (120 Hz / +105 °C)

*3: tanδ (120 Hz / +20 °C)

• Please refer to the page of "Reflow Profile" and "The Taping Dimensions".

• When requesting vibration-proof product, please put the last "V" instead to "P"

Surface Mount Type

Series : **HB** Type : **V**
High temperature
Lead-Free reflow (suffix : A*)



Features

- Endurance : 105 °C 2000 h
- Vibration-proof product is available upon request. (φ8 mm and larger)
- RoHS compliant

Specifications

Category temperature range	-40 °C to +105 °C								
Rated voltage range	6.3 V.DC to 50 V.DC								
Capacitance range	1 µF to 1500 µF								
Capacitance tolerance	±20 % (120 Hz/ +20 °C)								
Leakage current	I ≤ 0.01 CV or 3 (µA) After 2 minutes (Whichever is greater)								
Dissipation factor (tan δ)	Please see the attached characteristics list								
Characteristics at low temperature	Standard	V.DC	6.3	10	16	25	35	50	(Impedance ratio at 120 Hz)
		Z(-25 °C)/Z(+20 °C)	4	3	2	2	2	2	
	Z(-40 °C)/Z(+20 °C)	8	6	4	4	3	3		
	Miniaturization product	Z(-25 °C)/Z(+20 °C)	4	3	2	2	2	2	
		Z(-40 °C)/Z(+20 °C)	10	8	6	6	4	4	
Endurance	After applying rated working voltage for 2000 hours at +105 °C±2 °C and then being stabilized at +20 °C, capacitors shall meet the following limits.								
	Capacitance change	Within ±20 % of the initial value (16 V.DC or less : Within ±25 %, Miniaturization product : Within ±35 %)							
	tan δ	≤200 % of the initial limit							
	DC leakage current	Within the initial limit							
Shelf life	After storage for 1000 hours at +105 °C±2 °C with no voltage applied and then being stabilized at +20 °C, capacitors shall meet the limits specified in Endurance. (With voltage treatment)								
Resistance to soldering heat	After reflow soldering and then being stabilized at +20 °C, capacitors shall meet the following limits.								
	Capacitance change	Within ±10 % of the initial value							
	tan δ	Within the initial limit							
	DC leakage current	Within the initial limit							
AEC-Q200	AEC-Q200 compliant								

Frequency correction factor for ripple current

Frequency (Hz)	50, 60	120	1 k	10 k to
Correction factor	0.70	1.00	1.30	1.70

Marking

Example : 6.3 V.DC 22 µF
 Marking color : BLACK

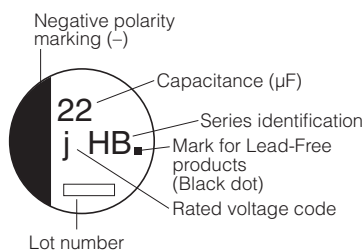

R. Voltage (V.DC)	6.3	10	16	25	35	50
Code	j	A	C	E	V	H

Dimensions

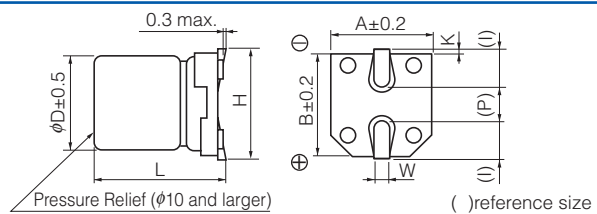

Size code	φD	L	A, B	H	I	W	P	K
B	4.0	5.8±0.3	4.3	5.5 max.	1.8	0.65±0.1	1.0	0.35 ^{+0.15} _{-0.20}
C	5.0	5.8±0.3	5.3	6.5 max.	2.2	0.65±0.1	1.5	0.35 ^{+0.15} _{-0.20}
D	6.3	5.8±0.3	6.6	7.8 max.	2.6	0.65±0.1	1.8	0.35 ^{+0.15} _{-0.20}
D8	6.3	7.7±0.3	6.6	7.8 max.	2.6	0.65±0.1	1.8	0.35 ^{+0.15} _{-0.20}
E	8.0	6.2±0.3	8.3	9.5 max.	3.4	0.65±0.1	2.2	0.35 ^{+0.15} _{-0.20}
F	8.0	10.2±0.3	8.3	10.0 max.	3.4	0.90±0.2	3.1	0.70±0.20
G	10.0	10.2±0.3	10.3	12.0 max.	3.5	0.90±0.2	4.6	0.70±0.20

Characteristics list

Endurance : 105 °C 2000 h

Rated voltage (V.DC)	Cap. (±20 %) (μF)	Case size (mm)		Size* code	Specification		Part No.	Reflow	Min. Packaging Q'ty
		φD	L		Ripple current (120 Hz) (+105 °C) (mA r.m.s.)	tan δ (120 Hz) (+20 °C)			Taping (pcs)
6.3	22	4	5.8	B	26	0.30	EEEHBOJ220AR	(5)	2000
	33	4	5.8	B	29	0.30	EEEHBOJ330AR	(5)	2000
	47	4	5.8	(B)	26	0.50	EEEHBJ470UAR	(5)	2000
		5	5.8	C	46	0.30	EEEHBOJ470AR	(5)	1000
	100	5	5.8	(C)	42	0.50	EEEHBJ101UAR	(5)	1000
		6.3	5.8	D	71	0.30	EEEHBOJ101AP	(5)	1000
	220	6.3	5.8	(D)	80	0.50	EEEHBJ221UAP	(5)	1000
		8	10.2	F	150	0.35	EEEHBOJ221AP	(7)	500
	330	8	6.2	(E)	180	0.50	EEEHBJ331UAP	(7)	1000
		8	10.2	F	230	0.35	EEEHBOJ331AP	(7)	500
470	8	10.2	(F)	230	0.50	EEEHBJ471UAP	(7)	500	
1500	10	10.2	(G)	290	0.50	EEEHBJ152UAP	(7)	500	
10	33	4	5.8	(B)	23	0.30	EEEHBA330UAR	(5)	2000
		5	5.8	C	43	0.26	EEEHBA1A330AR	(5)	1000
	68	6.3	5.8	D	70	0.22	EEEHBA1A680AP	(5)	1000
	100	6.3	5.8	(D)	71	0.30	EEEHBA101UAP	(5)	1000
		8	6.2	E	110	0.26	EEEHBA1A101AP	(7)	1000
	150	6.3	5.8	(D)	64	0.50	EEEHBA151UAP	(5)	1000
	220	8	6.2	(E)	110	0.30	EEEHBA221UAP	(7)	1000
		8	10.2	F	160	0.26	EEEHBA1A221AP	(7)	500
	470	8	10.2	(F)	220	0.35	EEEHBA471UAP	(7)	500
		10	10.2	G	270	0.26	EEEHBA1A471AP	(7)	500
16	10	4	5.8	B	28	0.16	EEEHB1C100AR	(5)	2000
	22	4	5.8	(B)	29.5	0.26	EEEHBC220UAR	(5)	2000
		5	5.8	C	39	0.16	EEEHB1C220AR	(5)	1000
	33	6.3	5.8	D	65	0.16	EEEHB1C330AP	(5)	1000
	47	5	5.8	(C)	39	0.26	EEEHBC470UAR	(5)	1000
		6.3	5.8	D	70	0.16	EEEHB1C470AP	(5)	1000
	6.3	7.7	D8	84	0.16	EEEHBC470XAP	(5)	900	
		6.3	5.8	(D)	70	0.26	EEEHBC101UAP	(5)	1000
	100	8	10.2	F	120	0.20	EEEHB1C101AP	(7)	500
		8	10.2	(F)	150	0.20	EEEHBC221UAP	(7)	500
	220	10	10.2	G	210	0.20	EEEHB1C221AP	(7)	500
		10	10.2	G	230	0.20	EEEHB1C331AP	(7)	500
	470	8	10.2	(F)	240	0.40	EEEHBC471UAP	(7)	500
		10	10.2	G	340	0.20	EEEHB1C471AP	(7)	500
25	4.7	4	5.8	B	22	0.14	EEEHB1E4R7AR	(5)	2000
	6.8	4	5.8	B	25	0.14	EEEHB1E6R8AR	(5)	2000
	10	4	5.8	(B)	28	0.16	EEEHBE100UAR	(5)	2000
		5	5.8	C	28	0.14	EEEHB1E100AR	(5)	1000
	22	6.3	5.8	D	55	0.14	EEEHB1E220AP	(5)	1000
	33	5	5.8	(C)	50	0.20	EEEHBE330UAR	(5)	1000
		6.3	5.8	D	65	0.14	EEEHB1E330AP	(5)	1000
	47	6.3	5.8	(D)	65	0.20	EEEHBE470UAR	(5)	1000
		8	6.2	E	91	0.16	EEEHB1E470AP	(7)	1000
	100	8	6.2	(E)	100	0.16	EEEHBE101UAP	(7)	1000
		8	10.2	F	130	0.16	EEEHB1E101AP	(7)	500
	220	8	10.2	(F)	130	0.30	EEEHBE221UAP	(7)	500
		10	10.2	G	190	0.16	EEEHB1E221AP	(7)	500
	330	8	10.2	(F)	130	0.30	EEEHBE331UAP	(7)	500
		10	10.2	G	220	0.16	EEEHB1E331AP	(7)	500
	470	10	10.2	(G)	230	0.30	EEEHBE471UAP	(7)	500

* Size code() : Miniaturization product

If Part number exceeds 12 digits, voltage code is abbreviated as follows; 0J → J, 1A → A, 1C → C, 1E → E, 1V → V

· Please refer to the page of "Reflow Profile" and "The Taping Dimensions".

· When requesting vibration-proof product, please put the last "V" instead to "P"

Characteristics list

Endurance : 105 °C 2000 h

Rated voltage (V.DC)	Cap. (±20 %) (μF)	Case size (mm)		Size* code	Specification		Part No.	Reflow	Min. Packaging Q'ty
		φD	L		Ripple current (120 Hz) (+105 °C) (mA r.m.s.)	tan δ (120 Hz) (+20 °C)			Taping (pcs)
35	4.7	4	5.8	B	21	0.12	EEEHB1V4R7AR	(5)	2000
	6.8	4	5.8	(B)	25	0.12	EEEHBV6R8UAR	(5)	2000
	10	5	5.8	C	28	0.12	EEEHB1V100AR	(5)	1000
	22	6.3	5.8	D	55	0.12	EEEHB1V220AP	(5)	1000
	33	8	6.2	E	84	0.14	EEEHB1V330AP	(7)	1000
	47	6.3	7.7	D8	98	0.20	EEEHBV470YAP	(5)	900
		8	6.2	(E)	91	0.18	EEEHBV470UAP	(7)	1000
		8	10.2	F	98	0.14	EEEHB1V470AP	(7)	500
	100	8	10.2	(F)	98	0.20	EEEHBV101UAP	(7)	500
		10	10.2	G	160	0.14	EEEHB1V101AP	(7)	500
220	10	10.2	(G)	180	0.14	EEEHBV221UAP	(7)	500	
50	1	4	5.8	B	10	0.12	EEEHB1H1R0AR	(5)	2000
	2.2	4	5.8	B	16	0.12	EEEHB1H2R2AR	(5)	2000
	3.3	4	5.8	B	16	0.12	EEEHB1H3R3AR	(5)	2000
	4.7	5	5.8	C	23	0.12	EEEHB1H4R7AR	(5)	1000
	6.8	5	5.8	C	23	0.12	EEEHB1H6R8AR	(5)	1000
	10	6.3	5.8	D	35	0.12	EEEHB1H100AP	(5)	1000
	22	6.3	5.8	(D)	35	0.14	EEEHBH220UAP	(5)	1000
		8	6.2	E	70	0.12	EEEHB1H220AP	(7)	1000
	33	8	10.2	F	91	0.12	EEEHB1H330AP	(7)	500
	47	6.3	7.7	D8	63	0.12	EEEHBH470YAP	(5)	900
		8	10.2	(F)	95	0.12	EEEHBH470UAP	(7)	500
		10	10.2	G	100	0.12	EEEHB1H470AP	(7)	500
	100	10	10.2	(G)	250	0.12	EEEHBH101UAP	(7)	500
	220	10	10.2	(G)	270	0.18	EEEHBH221UAP	(7)	500

* Size code() : Miniaturization product

If Part number exceeds 12 digits, voltage code is abbreviated as follows; 0J → J, 1A → A, 1C → C, 1E → E, 1V → V

· Please refer to the page of "Reflow Profile" and "The Taping Dimensions".

· When requesting vibration-proof product, please put the last "V" instead to "P"

Surface Mount Type

Series : **HB** Type : **V**

Long life

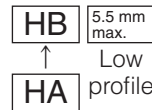

Features

- Endurance: 105 °C 2000 h
- 5.8 mm height (≤ φ6.3), 5.5 mm height max.
- Vibration-proof product is available upon request. (φ8 mm and larger)
- RoHS compliant

Specifications

Category temperature range	-40 °C to +105 °C								
Rated voltage range	4 V.DC to 50 V.DC								
Capacitance range	1 μF to 470 μF								
Capacitance tolerance	±20 % (120 Hz/+20 °C)								
Leakage current	I ≤ 0.01 CV or 3 (μA) After 2 minutes (Bi-polar I ≤ 0.02 CV or 6 (μA) after 2 minutes) (Whichever is greater)								
Dissipation factor (tan δ)	Please see the attached characteristics list								
Characteristics at low temperature	V.DC	4	6.3	10	16	25	35	50	(Impedance ratio at 120 Hz)
	Z(-25 °C)/Z(+20 °C)	7	4	3	2	2	2	2	
	Z(-40 °C)/Z(+20 °C)	15	8	6	4	4	3	3	
Endurance	After applying rated working voltage for 2000 hours (Bi-polar : 1000 hours for each polarity) at +105 °C±2 °C and then being stabilized at +20 °C, Capacitors shall meet the following limits.								
	Capacitance change	Within ±20 % of the initial value (4 V.DC : ±35 % 6.3 V.DC : ±25 % φ4 to φ6.3), 5.5 mm max. : ±25 %							
	tan δ	≤ 200 % of the initial limit							
Shelf life	DC leakage current								
	Within the initial limit								
Resistance to soldering heat	After storage for 1000 hours at +105 °C±2 °C with no voltage applied and then being stabilized at +20 °C, capacitors shall meet the limits specified in Endurance. (With voltage treatment)								
	After reflow soldering and then being stabilized at +20 °C, capacitors shall meet the following limits.								
	Capacitance change	Within ±10 % of the initial value							
AEC-Q200	tan δ	Within the initial limit							
	DC leakage current	Within the initial limit							
AEC-Q200	AEC-Q200 compliant								

Frequency correction factor for ripple current

Frequency (Hz)	50, 60	120	1 k	10 k to
Correction factor	0.70	1.00	1.30	1.70

Marking

Example : 4 V.DC 47 μF
Marking color : BLACK

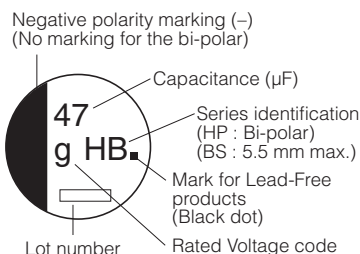

R. Voltage (V.DC)	4	6.3	10	16	25	35	50
Code	g	j	A	C	E	V	H

Dimensions

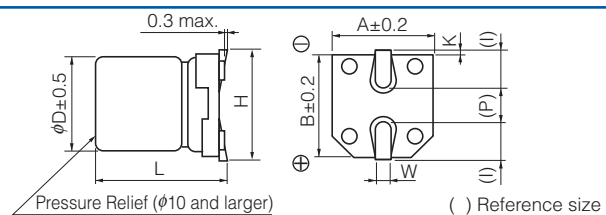

Size code	φD	L	A, B	H	I	W	P	K
B	4.0	5.8±0.3	4.3	5.5 max.	1.8	0.65±0.1	1.0	0.35 ^{+0.15} _{-0.20}
C	5.0	5.8±0.3	5.3	6.5 max.	2.2	0.65±0.1	1.5	0.35 ^{+0.15} _{-0.20}
D	6.3	5.8±0.3	6.6	7.8 max.	2.6	0.65±0.1	1.8	0.35 ^{+0.15} _{-0.20}
E	8.0	6.2±0.3	8.3	9.5 max.	3.4	0.65±0.1	2.2	0.35 ^{+0.15} _{-0.20}
F	8.0	10.2±0.3	8.3	10.0 max.	3.4	0.90±0.2	3.1	0.70±0.20
G	10.0	10.2±0.3	10.3	12.0 max.	3.5	0.90±0.2	4.6	0.70±0.20

● 5.5 mm height max.

Size code	φD	L	A, B	H	I	W	P	K
B	4.0	5.4 ^{+0.1} _{-0.2}	4.3	5.5 max.	1.8	0.65±0.1	1.0	0.35 ^{+0.15} _{-0.20}
C	5.0	5.4 ^{+0.1} _{-0.2}	5.3	6.5 max.	2.2	0.65±0.1	1.5	0.35 ^{+0.15} _{-0.20}
D	6.3	5.4 ^{+0.1} _{-0.2}	6.6	7.8 max.	2.6	0.65±0.1	1.8	0.35 ^{+0.15} _{-0.20}

Characteristics list

Endurance : 105 °C 2000 h

Rated voltage (V.DC)	Cap. (±20 %) (μF)	Case size (mm)		Size code	Specification		Part No.	Reflow	Min. Packaging Q'ty
		φD	L		Ripple current (120 Hz) (+105 °C) (mA r.m.s.)	tan δ (120 Hz) (+20 °C)			Taping (pcs)
4	47	4	5.8	B	34	0.50	EEEHB0G470R	(1)	2000
	100	5	5.8	C	61	0.50	EEEHB0G101R	(1)	1000
	150	6.3	5.8	D	82	0.50	EEEHB0G151P	(1)	1000
	220	6.3	5.8	D	82	0.50	EEEHB0G221P	(1)	1000
6.3	22	4	5.8	B	26	0.30	EEEHB0J220R	(1)	2000
	33	4	5.8	B	29	0.30	EEEHB0J330R	(1)	2000
	47	5	5.8	C	46	0.30	EEEHB0J470R	(1)	1000
	100	6.3	5.8	D	71	0.30	EEEHB0J101P	(1)	1000
	220	8	10.2	F	150	0.35	EEEHB0J221P	(2)	500
	330	8	10.2	F	230	0.35	EEEHB0J331P	(2)	500
10	33	5	5.8	C	43	0.22	EEEHB1A330R	(1)	1000
	100	8	6.2	E	110	0.26	EEEHB1A101P	(2)	1000
	220	8	10.2	F	160	0.26	EEEHB1A221P	(2)	500
	470	10	10.2	G	270	0.26	EEEHB1A471P	(2)	500
16	10	4	5.8	B	28	0.16	EEEHB1C100R	(1)	2000
	22	5	5.8	C	39	0.16	EEEHB1C220R	(1)	1000
	47	6.3	5.8	D	70	0.16	EEEHB1C470P	(1)	1000
	100	8	10.2	F	120	0.20	EEEHB1C101P	(2)	500
	220	10	10.2	G	210	0.20	EEEHB1C221P	(2)	500
	330	10	10.2	G	230	0.20	EEEHB1C331P	(2)	500
25	4.7	4	5.8	B	22	0.14	EEEHB1E4R7R	(1)	2000
	6.8	4	5.8	B	25	0.14	EEEHB1E6R8R	(1)	2000
	33	6.3	5.8	D	65	0.14	EEEHB1E330P	(1)	1000
	47	8	6.2	E	91	0.16	EEEHB1E470P	(2)	1000
	100	8	10.2	F	130	0.16	EEEHB1E101P	(2)	500
	220	10	10.2	G	190	0.16	EEEHB1E221P	(2)	500
35	10	5	5.8	C	28	0.12	EEEHB1V100R	(1)	1000
	22	6.3	5.8	D	55	0.12	EEEHB1V220P	(1)	1000
	33	8	6.2	E	84	0.14	EEEHB1V330P	(2)	1000
	47	8	10.2	F	98	0.14	EEEHB1V470P	(2)	500
	100	10	10.2	G	160	0.14	EEEHB1V101P	(2)	500
50	1	4	5.8	B	10	0.12	EEEHB1H1R0R	(1)	2000
	2.2	4	5.8	B	16	0.12	EEEHB1H2R2R	(1)	2000
	3.3	4	5.8	B	16	0.12	EEEHB1H3R3R	(1)	2000
	4.7	5	5.8	C	23	0.12	EEEHB1H4R7R	(1)	1000
	6.8	5	5.8	C	23	0.12	EEEHB1H6R8R	(1)	1000
	10	6.3	5.8	D	35	0.12	EEEHB1H100P	(1)	1000
	22	8	6.2	E	70	0.12	EEEHB1H220P	(2)	1000
	33	8	10.2	F	91	0.12	EEEHB1H330P	(2)	500
47	10	10.2	G	100	0.12	EEEHB1H470P	(2)	500	

· Please refer to the page of "Reflow Profile" and "The Taping Dimensions".

· When requesting vibration-proof product, please put the last "V" instead to "P"

Characteristics list (Bi-polar)

Endurance : 105 °C 2000 h

Rated voltage (V.DC)	Cap. (±20 %) (μF)	Case size (mm)		Size code	Specification		Part No.	Reflow	Min. Packaging Q'ty
		φD	L		Ripple current (120 Hz) (+105 °C) (mA r.m.s.)	tan δ (120 Hz) (+20 °C)			Taping (pcs)
6.3	47	6.3	5.8	D	35	0.60	EEEHP0J470P	(1)	1000
10	10	4	5.8	B	20	0.44	EEEHP1A100R	(1)	2000
	33	6.3	5.8	D	26	0.44	EEEHP1A330P	(1)	1000
16	10	5	5.8	C	25	0.32	EEEHP1C100R	(1)	1000
25	3.3	4	5.8	B	12	0.28	EEEHP1E3R3R	(1)	2000
	4.7	4	5.8	B	12	0.28	EEEHP1E4R7R	(1)	2000
	10	6.3	5.8	D	28	0.28	EEEHP1E100P	(1)	1000
	22	6.3	5.8	D	55	0.28	EEEHP1E220P	(1)	1000
35	2.2	4	5.8	B	10	0.24	EEEHP1V2R2R	(1)	2000
50	1	4	5.8	B	10	0.24	EEEHP1H1R0R	(1)	2000
	3.3	6.3	5.8	D	16	0.24	EEEHP1H3R3P	(1)	1000
	4.7	6.3	5.8	D	23	0.24	EEEHP1H4R7P	(1)	1000

Characteristics list (5.5 mm max.)

Endurance : 105 °C 2000 h

Rated voltage (V.DC)	Cap. (±20 %) (μF)	Case size (mm)		Size code	Specification		Part No.	Reflow	Min. Packaging Q'ty
		φD	L		Ripple current (120 Hz) (+105 °C) (mA r.m.s.)	tan δ (120 Hz) (+20 °C)			Taping (pcs)
6.3	22	4	5.4	B	26	0.30	EEEHB0J220SR	(1)	2000
	47	5	5.4	C	46	0.30	EEEHB0J470SR	(1)	1000
	100	6.3	5.4	D	71	0.30	EEEHB0J101SP	(1)	1000
10	33	5	5.4	C	43	0.22	EEEHB1A330SR	(1)	1000
16	10	4	5.4	B	28	0.16	EEEHB1C100SR	(1)	2000
	22	5	5.4	C	39	0.16	EEEHB1C220SR	(1)	1000
	47	6.3	5.4	D	70	0.16	EEEHB1C470SP	(1)	1000
25	4.7	4	5.4	B	22	0.14	EEEHB1E4R7SR	(1)	2000
	6.8	4	5.4	B	25	0.14	EEEHB1E6R8SR	(1)	2000
	33	6.3	5.4	D	65	0.14	EEEHB1E330SP	(1)	1000
35	10	5	5.4	C	28	0.12	EEEHB1V100SR	(1)	1000
	22	6.3	5.4	D	55	0.12	EEEHB1V220SP	(1)	1000
50	1	4	5.4	B	10	0.12	EEEHB1H1R0SR	(1)	2000
	2.2	4	5.4	B	16	0.12	EEEHB1H2R2SR	(1)	2000
	3.3	4	5.4	B	16	0.12	EEEHB1H3R3SR	(1)	2000
	4.7	5	5.4	C	23	0.12	EEEHB1H4R7SR	(1)	1000
	6.8	5	5.4	C	23	0.12	EEEHB1H6R8SR	(1)	1000
	10	6.3	5.4	D	35	0.12	EEEHB1H100SP	(1)	1000

· Please refer to the page of "Reflow Profile" and "The Taping Dimensions".

· When requesting vibration-proof product, please put the last "V" instead to "P"

Surface Mount Type

Series : **HC** Type : **V**

Long life

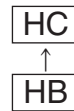

Features

- Endurance : 105 °C 3000 h to 5000 h
- Vibration-proof product is available upon request. ($\phi 8$ mm and larger)
- RoHS compliant

Specifications

Category temperature range	-40 °C to +105 °C	
Rated voltage range	6.3 V.DC to 50 V.DC	
Capacitance range	1 μ F to 1000 μ F	
Capacitance tolerance	± 20 % (120 Hz/+20 °C)	
Leakage current	$I \leq 0.01 CV$ or 3 (μ A) After 2 minutes (Whichever is greater)	
Dissipation factor (tan δ)	Please see the attached characteristics list	
Endurance	After applying rated working voltage for +105 °C ± 2 °C and then being stabilized at +20 °C, Capacitors shall meet the following limits. $\phi 4$ to $\phi 6.3$ (3000 hours After applying rated working voltage) $\phi 8$ to $\phi 10$ (5000 hours After applying rated working voltage)	
	Capacitance change	Within ± 30 % of the initial value
	tan δ	≤ 300 % of the initial limit
	DC leakage current	Within the initial limit
Shelf life	After storage for 1000 hours at +105 °C ± 2 °C with no voltage applied and then being stabilized at +20 °C, capacitors shall meet the limits specified in Endurance. (With voltage treatment)	
Resistance to soldering heat	Capacitance change	Within ± 10 % of the initial value
	tan δ	Within the initial limit
	DC leakage current	Within the initial limit
AEC-Q200	AEC-Q200 compliant	

Frequency correction factor for ripple current

Frequency (Hz)	50, 60	120	1 k	10 k to
Correction factor	0.70	1.00	1.30	1.70

Marking

Example : 6.3 V.DC 22 μ F
Marking color : BLACK

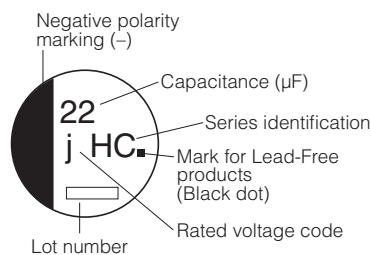

R. Voltage (V.DC)	6.3	10	16	25	35	50
Code	j	A	C	E	V	H

Dimensions

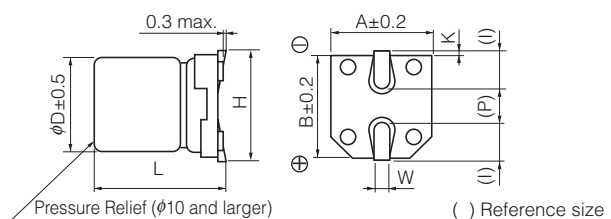

(Unit : mm)

Size code	ϕD	L	A, B	H	I	W	P	K
B	4.0	5.8 ± 0.3	4.3	5.5 max.	1.8	0.65 ± 0.1	1.0	0.35 $^{+0.15}_{-0.20}$
C	5.0	5.8 ± 0.3	5.3	6.5 max.	2.2	0.65 ± 0.1	1.5	0.35 $^{+0.15}_{-0.20}$
D	6.3	5.8 ± 0.3	6.6	7.8 max.	2.6	0.65 ± 0.1	1.8	0.35 $^{+0.15}_{-0.20}$
D8	6.3	7.7 ± 0.3	6.6	7.8 max.	2.6	0.65 ± 0.1	1.8	0.35 $^{+0.15}_{-0.20}$
F	8.0	10.2 ± 0.3	8.3	10.0 max.	3.4	0.90 ± 0.2	3.1	0.70 ± 0.2
G	10.0	10.2 ± 0.3	10.3	12.0 max.	3.5	0.90 ± 0.2	4.6	0.70 ± 0.2

Characteristics list

Endurance : 105 °C 3000 h ($\phi 8, \phi 10$: 5000 h)

Rated voltage (V.DC)	Cap. ($\pm 20\%$) (μF)	Case size (mm)		Size code	Specification		Part No.	Reflow	Min. Packaging Q'ty
		ϕD	L		Ripple current (120 Hz) (+105 °C) (mA r.m.s.)	$\tan \delta$ (120 Hz) (+20 °C)			Taping (pcs)
6.3	22	4	5.8	B	26	0.30	EEEHC0J220R	(1)	2000
	47	5	5.8	C	46	0.30	EEEHC0J470R	(1)	1000
	100	6.3	5.8	D	71	0.30	EEEHC0J101P	(1)	1000
	220	6.3	7.7	D8	101	0.30	EEEHC0J221XP	(1)	900
	330	8	10.2	F	230	0.30	EEEHC0J331P	(2)	500
	1000	10	10.2	G	313	0.50	EEEHC0J102P	(2)	500
10	33	5	5.8	C	43	0.26	EEEHC1A330R	(1)	1000
	220	8	10.2	F	160	0.26	EEEHC1A221P	(2)	500
16	10	4	5.8	B	28	0.20	EEEHC1C100R	(1)	2000
	22	5	5.8	C	39	0.20	EEEHC1C220R	(1)	1000
	47	6.3	5.8	D	70	0.20	EEEHC1C470P	(1)	1000
	100	6.3	7.7	D8	81	0.20	EEEHC1C101XP	(1)	900
	470	10	10.2	G	340	0.20	EEEHC1C471P	(2)	500
25	33	6.3	5.8	D	65	0.16	EEEHC1E330P	(1)	1000
	47	6.3	7.7	D8	65	0.16	EEEHC1E470XP	(1)	900
	100	8	10.2	F	130	0.16	EEEHC1E101P	(2)	500
	330	10	10.2	G	238	0.16	EEEHC1E331P	(2)	500
35	4.7	4	5.8	B	15	0.14	EEEHC1V4R7R	(1)	2000
	10	5	5.8	C	28	0.14	EEEHC1V100R	(1)	1000
	22	6.3	5.8	D	55	0.14	EEEHC1V220P	(1)	1000
	33	6.3	7.7	D8	57	0.14	EEEHC1V330XP	(1)	900
	220	10	10.2	G	220	0.14	EEEHC1V221P	(2)	500
50	1	4	5.8	B	10	0.12	EEEHC1H1R0R	(1)	2000
	2.2	4	5.8	B	16	0.12	EEEHC1H2R2R	(1)	2000
	3.3	4	5.8	B	16	0.12	EEEHC1H3R3R	(1)	2000
	4.7	5	5.8	C	23	0.12	EEEHC1H4R7R	(1)	1000
	10	6.3	5.8	D	35	0.12	EEEHC1H100P	(1)	1000
	22	6.3	7.7	D8	49	0.12	EEEHC1H220XP	(1)	900
	33	8	10.2	F	91	0.12	EEEHC1H330P	(2)	500
	47	8	10.2	F	100	0.12	EEEHC1H470P	(2)	500
100	10	10.2	G	160	0.12	EEEHC1H101P	(2)	500	

· Please refer to the page of "Reflow Profile" and "The Taping Dimensions".

· When requesting vibration-proof product, please put the last "V" instead to "P"

Surface Mount Type

Series : **HD** Type : **V**

✳ 6.3 V.DC to 35 V.DC : High temperature Lead-Free reflow (suffix : A*)
50 V.DC to 100 V.DC : Standard Lead-Free reflow



Features

- Endurance : 105 °C 5000 h
- Vibration-proof product is available upon request. (φ8 mm and larger)
- RoHS compliant

Specifications

Category temperature range	-40 °C to +105 °C									
Rated voltage range	6.3 V.DC to 100 V.DC									
Capacitance range	1 µF to 1000 µF									
Capacitance tolerance	±20 % (120 Hz/+20 °C)									
Leakage current	I ≤ 0.01 CV or 3 (µA) After 2 minutes (Whichever is greater)									
Dissipation factor (tan δ)	Please see the attached characteristics list									
Characteristics at low temperature	V.DC	6.3	10	16	25	35	50	63	100	(Impedance ratio at 120 Hz)
	Z(-25 °C)/Z(+20 °C)	3	3	2	2	2	2	2	2	
	Z(-40 °C)/Z(+20 °C)	4	4	3	3	3	3	3	3	
Endurance	After applying rated working voltage for 5000 hours at +105 °C±2 °C and then being stabilized at +20 °C, capacitors shall meet the following limits.									
	Capacitance change	Within ±30 % of the initial value								
	tan δ	≤ 300 % of the initial limit								
Shelf life	After storage for 1000 hours at +105 °C±2 °C with no voltage applied and then being stabilized at +20 °C, capacitors shall meet the limits specified in Endurance. (With voltage treatment)									
	Capacitance change	Within ±20 % of the initial value								
	tan δ	≤ 200 % of the initial limit								
Resistance to soldering heat	After reflow soldering and then being stabilized at +20 °C, capacitors shall meet the following limits.									
	Capacitance change	Within ±10 % of the initial value								
	tan δ	Within the initial limit								
AEC-Q200	AEC-Q200 compliant									

Frequency correction factor for ripple current

Frequency (Hz)	50, 60	120	1 k	10 k to
Correction factor	0.70	1.00	1.30	1.70

Marking

Example : 6.3 V.DC 330 µF
Marking color : BLACK

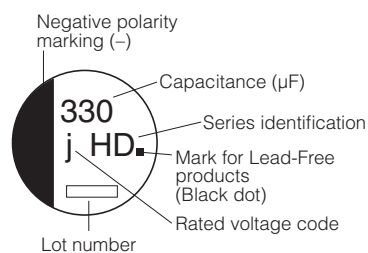

R. Voltage (V.DC)	6.3	10	16	25	35	50	63	100
Code	j	A	C	E	V	H	J	2A

Dimensions

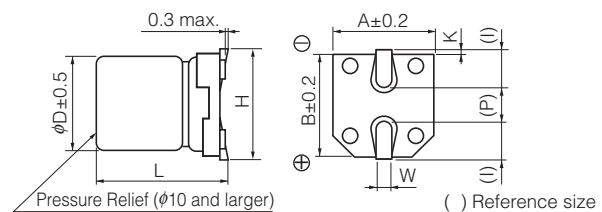

(Unit : mm)

Size code	φD	L	A, B	H	I	W	P	K
B	4.0	5.8±0.3	4.3	5.5 max.	1.8	0.65±0.1	1.0	0.35 ^{+0.15} _{-0.20}
C	5.0	5.8±0.3	5.3	6.5 max.	2.2	0.65±0.1	1.5	0.35 ^{+0.15} _{-0.20}
D	6.3	5.8±0.3	6.6	7.8 max.	2.6	0.65±0.1	1.8	0.35 ^{+0.15} _{-0.20}
D8	6.3	7.7±0.3	6.6	7.8 max.	2.6	0.65±0.1	1.8	0.35 ^{+0.15} _{-0.20}
E	8.0	6.2±0.3	8.3	9.5 max.	3.4	0.65±0.1	2.2	0.35 ^{+0.15} _{-0.20}
F	8.0	10.2±0.3	8.3	10.0 max.	3.4	0.90±0.2	3.1	0.70±0.20
G	10.0	10.2±0.3	10.3	12.0 max.	3.5	0.90±0.2	4.6	0.70±0.20

Characteristics list (6.3 V.DC to 35 V.DC)

Endurance : 105 °C 5000 h

Rated voltage (V.DC)	Cap. (±20 %) (μF)	Case size (mm)		Size code	Specification			Part No.	Reflow	Min. Packaging Qty	
		φD	L		Ripple current (120 Hz) (+105 °C) (mA r.m.s.)	Impedance (100 kHz) (+20 °C) (Ω)	tan δ (120 Hz) (+20 °C)			Taping (pcs)	
6.3	330	8	10.2	F	230	1.5	0.30	EEEHD0J331AP	(7)	500	
	1000	10	10.2	G	313	0.8	0.50	EEEHD0J102AP	(7)	500	
10	100	8	6.2	E	62	2.0	0.30	EEEHD1A101AP	(7)	1000	
	220	8	10.2	F	160	1.5	0.30	EEEHD1A221AP	(7)	500	
	330	8	10.2	F	160	1.5	0.30	EEEHD1A331AP	(7)	500	
16	10	4.0	5.8	B	28	12.0	0.20	EEEHD1C100AR	(5)	2000	
	22	5.0	5.8	C	39	7.2	0.20	EEEHD1C220AR	(5)	1000	
	47	6.3	5.8	D	70	4.0	0.20	EEEHD1C470AP	(5)	1000	
	100	8	10.2	F	130	1.5	0.20	EEEHD1C101AP	(7)	500	
	220	10	10.2	G	220	0.8	0.20	EEEHD1C221AP	(7)	500	
	470	10	10.2	G	340	0.8	0.20	EEEHD1C471AP	(7)	500	
25	4.7	4	5.8	B	17	12.0	0.16	EEEHD1E4R7AR	(5)	2000	
	10	5	5.8	C	28	7.2	0.16	EEEHD1E100AR	(5)	1000	
	22	6.3	5.8	D	55	4.0	0.16	EEEHD1E220AP	(5)	1000	
	33	6.3	5.8	D	55	4.0	0.16	EEEHD1E330AP	(5)	1000	
	47	8	6.2	E	56	2.0	0.18	EEEHD1E470AP	(7)	1000	
	100	8	10.2	F	130	1.5	0.16	EEEHD1E101AP	(7)	500	
	330	10	10.2	G	238	0.8	0.16	EEEHD1E331AP	(7)	500	
35	4.7	4	5.8	B	17	12.0	0.13	EEEHD1V4R7AR	(5)	2000	
	10	5	5.8	C	28	7.2	0.13	EEEHD1V100AR	(5)	1000	
	22	6.3	5.8	D	55	4.0	0.13	EEEHD1V220AP	(5)	1000	
	33	8	6.2	E	53	2.0	0.16	EEEHD1V330AP	(7)	1000	
		6.3	7.7	D8	57	2.0	0.13	EEEHDV330XAP	(5)	900	
	47	6.3	7.7	D8	57	2.0	0.14	EEEHDV470XAP	(5)	900	
		8	10.2	F	79	1.5	0.14	EEEHD1V470AP	(7)	500	
	100	10	10.2	G	101	0.8	0.14	EEEHD1V101AP	(7)	500	
	220	10	10.2	G	220	0.8	0.14	EEEHD1V221AP	(7)	500	

Characteristics list (50 V.DC to 100 V.DC)

Endurance : 105 °C 5000 h

Rated voltage (V.DC)	Cap. (±20 %) (μF)	Case size (mm)		Size code	Specification			Part No.	Reflow	Min. Packaging Qty	
		φD	L		Ripple current (120 Hz) (+105 °C) (mA r.m.s.)	Impedance (100 kHz) (+20 °C) (Ω)	tan δ (120 Hz) (+20 °C)			Taping (pcs)	
50	1	4	5.8	B	7	12.0	0.12	EEEHD1H1R0R	(1)	2000	
	2.2	4	5.8	B	12	12.0	0.12	EEEHD1H2R2R	(1)	2000	
	3.3	4	5.8	B	16	12.0	0.12	EEEHD1H3R3R	(1)	2000	
	4.7	5	5.8	C	21	7.2	0.12	EEEHD1H4R7R	(1)	1000	
	10	6.3	5.8	D	33	4.0	0.12	EEEHD1H100P	(1)	1000	
	22	8	6.2	E	50	2.0	0.14	EEEHD1H220P	(2)	1000	
	33	8	10.2	F	74	1.5	0.14	EEEHD1H330P	(2)	500	
	47	10	10.2	G	94	0.8	0.14	EEEHD1H470P	(2)	500	
63	100	10	10.2	G	94	0.8	0.14	EEEHD1H101P	(2)	500	
	10	8	6.2	E	45	2.0	0.18	EEEHD1J100P	(2)	1000	
	22	8	10.2	F	65	1.5	0.18	EEEHD1J220P	(2)	500	
100	33	10	10.2	G	80	0.8	0.18	EEEHD1J330P	(2)	500	
	10	8	10.2	F	55	1.5	0.18	EEEHD2A100P	(2)	500	
	22	10	10.2	G	70	0.8	0.18	EEEHD2A220P	(2)	500	

If Part number exceeds 12 digits, voltage code is abbreviated as follows; 0J → J, 1A → A, 1C → C, 1E → E, 1V → V,

· Please refer to the page of "Reflow Profile" and "The Taping Dimensions".

· When requesting vibration-proof product, please put the last "V" instead of "P"

Surface Mount Type

Series : Medium-size **HD** Type : **V**
High temperature
Lead-Free reflow (suffix : A*)



Features

- Endurance : 105 °C 5000 h
- Vibration-proof product is available upon request.
- RoHS compliant

Specifications

Category temperature range	-55 °C to +105 °C	
Rated voltage range	6.3 V.DC to 35 V.DC	
Capacitance range	680 µF to 7500 µF	
Capacitance tolerance	±20 % (120 Hz/+20 °C)	
Leakage current	I ≤ 0.01 CV (µA) After 2 minutes	
Dissipation factor (tan δ)	Please see the attached characteristics list	
Endurance	After applying rated working voltage for 5000 hours at +105 °C±2 °C and then being stabilized at +20 °C, Capacitors shall meet the following limits.	
	Capacitance change	Within ±30 % of the initial value
	tan δ	≤200 % of the initial limit
Shelf life	After storage for 1000 hours at +105 °C±2 °C with no voltage applied and then being stabilized at +20 °C, capacitors shall meet the limits specified in Endurance (With voltage treatment)	
	After reflow soldering and then being stabilized at +20 °C, capacitors shall meet the following limits.	
Resistance to soldering heat	Capacitance change	
	tan δ	Within the initial limit
	DC leakage current	Within the initial limit
AEC-Q200	AEC-Q200 compliant	

Frequency correction factor for ripple current

Capacitance (µF)	Frequency (Hz)					
	60	120	1 k	10 k	100 k to	
680 to 1000	0.93	1.00	1.20	1.27	1.33	
1200 to 2200	0.94	1.00	1.13	1.19	1.25	
2700 to 7500	0.94	1.00	1.12	1.18	1.18	

Marking

Example : 6.3 V.DC 3300 µF
 Marking color : BLACK

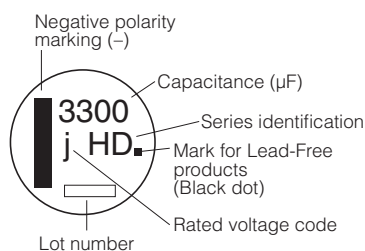

R. Voltage (V.DC)	6.3	10	16	25	35
Code	j	A	C	E	V

Dimensions

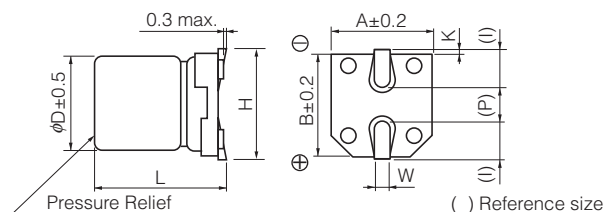

(Unit : mm)

Size code	φD	L	A,B	H	I	W	P	K
H13	12.5	13.5±0.5	13.5	15.0 max.	4.7	0.90±0.3	4.4	0.70±0.3
J16	16.0	16.5±0.5	17.0	19.0 max.	5.5	1.20±0.3	6.7	0.70±0.3
K16	18.0	16.5±0.5	19.0	21.0 max.	6.7	1.20±0.3	6.7	0.70±0.3

Characteristics list

Endurance : 105 °C 5000 h

Rated voltage (V.DC)	Cap. (±20 %) (μF)	Case size (mm)		Size code	Specification		Part No.	Reflow	Min. Packaging Q'ty
		φD	L		Ripple current (120 Hz) (+105 °C) (mA r.m.s.)	tan δ (120 Hz) (+20 °C)			Taping (pcs)
6.3	3300	12.5	13.5	H13	680	0.32	EEEHD0J332AQ	(9)	200
	6800	16	16.5	J16	1280	0.38	EEEHD0J682AM	(9)	125
	7500	18	16.5	K16	1540	0.40	EEEHD0J752AM	(9)	125
10	2200	12.5	13.5	H13	620	0.24	EEEHD1A222AQ	(9)	200
	4700	16	16.5	J16	1280	0.28	EEEHD1A472AM	(9)	125
	6800	18	16.5	K16	1540	0.32	EEEHD1A682AM	(9)	125
16	1500	12.5	13.5	H13	620	0.18	EEEHD1C152AQ	(9)	200
	3300	16	16.5	J16	1280	0.22	EEEHD1C332AM	(9)	125
	4700	18	16.5	K16	1540	0.24	EEEHD1C472AM	(9)	125
25	1000	12.5	13.5	H13	580	0.16	EEEHD1E102AQ	(9)	200
	2200	16	16.5	J16	1200	0.18	EEEHD1E222AM	(9)	125
	3300	18	16.5	K16	1540	0.20	EEEHD1E332AM	(9)	125
35	680	12.5	13.5	H13	580	0.14	EEEHD1V681AQ	(9)	200
	1500	16	16.5	J16	1200	0.16	EEEHD1V152AM	(9)	125
	1800	18	16.5	K16	1450	0.16	EEEHD1V182AM	(9)	125

· Please refer to the page of "Reflow Profile" and "The Taping Dimensions".

· When requesting vibration-proof product, please put the last "V" instead to "P" or "M"

Surface Mount Type

Series : **FC** Type : **V**
High temperature
Lead-Free reflow (suffix : A*)

Low impedance



Features

- Endurance : 105 °C 1000 h
- Low impedance (1/2 for HA series)
- Vibration-proof product is available upon request. ($\phi 8$ mm and larger)
- RoHS compliant

Specifications

Category temperature range	-40 °C to +105 °C						
Rated voltage range	6.3 V.DC to 35 V.DC						
Capacitance range	1 μ F to 1500 μ F						
Capacitance tolerance	± 20 % (120 Hz/+20 °C)						
Leakage current	$I \leq 0.01 CV$ or 3 (μ A) After 2 minutes (Whichever is greater)						
Dissipation factor (tan δ)	Please see the attached characteristics list						
Characteristics at low temperature	V.DC	6.3	10	16	25	35	(Impedance ratio at 120 Hz)
	Z(-25 °C) / Z(+20 °C)	2	2	2	2	2	
	Z(-40 °C) / Z(+20 °C)	3	3	3	3	3	
Endurance	After applying rated working voltage for 1000 hours at +105 °C ± 2 °C and then being stabilized at +20 °C, Capacitors shall meet the following limits.						
	Capacitance change	Within ± 20 % of the initial value					
	tan δ	≤ 200 % of the initial limit					
	DC leakage current	Within the initial limit					
Shelf life	After storage for 1000 hours at +105 °C ± 2 °C with no voltage applied and then being stabilized at +20 °C, capacitors shall meet the limits specified in Endurance.(With voltage treatment)						
Resistance to soldering heat	After reflow soldering and then being stabilized at +20 °C, capacitors shall meet the following limits.						
	Capacitance change	Within ± 10 % of the initial value					
	tan δ	Within the initial limit					
	DC leakage current	Within the initial limit					
AEC-Q200	AEC-Q200 compliant						

Frequency correction factor for ripple current

Frequency (Hz)	50, 60	120	1 k	10 k	100 k to
Correction factor	0.70	0.75	0.90	0.95	1.00

Marking

Example : 6.3 V.DC 22 μ F
 Marking color : BLACK

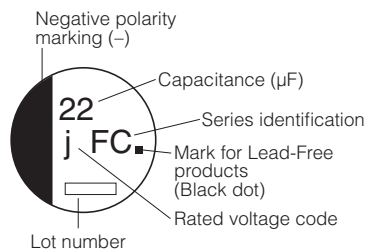

R. Voltage (V.DC)	6.3	10	16	25	35
Code	j	A	C	E	V

Dimensions

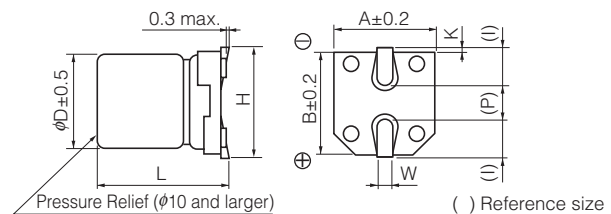

(Unit : mm)

Size code	ϕD	L	A, B	H	I	W	P	K
B	4.0	5.4 $^{+0.1}_{-0.2}$	4.3	5.5 max.	1.8	0.65 ± 0.1	1.0	0.35 $^{+0.15}_{-0.20}$
C	5.0	5.4 $^{+0.1}_{-0.2}$	5.3	6.5 max.	2.2	0.65 ± 0.1	1.5	0.35 $^{+0.15}_{-0.20}$
D	6.3	5.4 $^{+0.1}_{-0.2}$	6.6	7.8 max.	2.6	0.65 ± 0.1	1.8	0.35 $^{+0.15}_{-0.20}$
E	8.0	6.2 ± 0.3	8.3	9.5 max.	3.4	0.65 ± 0.1	2.2	0.35 $^{+0.15}_{-0.20}$
F	8.0	10.2 ± 0.3	8.3	10.0 max.	3.4	0.90 ± 0.2	3.1	0.70 ± 0.2
G	10.0	10.2 ± 0.3	10.3	12.0 max.	3.5	0.90 ± 0.2	4.6	0.70 ± 0.2

Characteristics list

Endurance : 105 °C 1000 h

Rated voltage (V.DC)	Cap. (±20 %) (μF)	Case size (mm)		Size code	Specification			Part No.	Reflow	Min. Packaging Q'ty
		φD	L		Ripple current (100 kHz) (+105 °C) (mA r.m.s.)	Impedance (100 kHz) (+20 °C) (Ω)	tan δ (120 Hz) (+20 °C)			
6.3	22	4	5.4	B	60	3.00	0.26	EEEFC0J220AR	(5)	2000
	47	5	5.4	C	95	1.80	0.26	EEEFC0J470AR	(5)	1000
	68	6.3	5.4	D	140	1.00	0.26	EEEFC0J680AP	(5)	1000
	100	6.3	5.4	D	140	1.00	0.26	EEEFC0J101AP	(5)	1000
	220	8	6.2	E	230	0.40	0.26	EEEFC0J221AP	(6)	1000
	330	8	10.2	F	450	0.30	0.26	EEEFC0J331AP	(6)	500
	1000	10	10.2	G	670	0.15	0.26	EEEFC0J102AP	(6)	500
	1500	10	10.2	G	670	0.15	0.26	EEEFC0J152AP	(6)	500
10	33	5	5.4	C	95	1.80	0.19	EEEFC1A330AR	(5)	1000
	100	8	6.2	E	230	0.40	0.19	EEEFC1A101AP	(6)	1000
	150	8	6.2	E	230	0.40	0.19	EEEFC1A151AP	(6)	1000
	220	8	10.2	F	450	0.30	0.19	EEEFC1A221AP	(6)	500
	470	10	10.2	G	670	0.15	0.19	EEEFC1A471AP	(6)	500
	1000	10	10.2	G	670	0.15	0.19	EEEFC1A102AP	(6)	500
16	10	4	5.4	B	60	3.00	0.16	EEEFC1C100AR	(5)	2000
	22	5	5.4	C	95	1.80	0.16	EEEFC1C220AR	(5)	1000
	47	6.3	5.4	D	140	1.00	0.16	EEEFC1C470AP	(5)	1000
	68	8	6.2	E	230	0.40	0.16	EEEFC1C680AP	(6)	1000
	100	8	6.2	E	230	0.40	0.16	EEEFC1C101AP	(6)	1000
	220	10	10.2	G	670	0.15	0.16	EEEFC1C221AP	(6)	500
	330	10	10.2	G	670	0.15	0.16	EEEFC1C331AP	(6)	500
	470	10	10.2	G	670	0.15	0.16	EEEFC1C471AP	(6)	500
	680	10	10.2	G	670	0.15	0.16	EEEFC1C681AP	(6)	500
25	6.8	4	5.4	B	60	3.00	0.14	EEEFC1E6R8AR	(5)	2000
	22	6.3	5.4	D	140	1.00	0.14	EEEFC1E220AP	(5)	1000
	33	6.3	5.4	D	140	1.00	0.14	EEEFC1E330AP	(5)	1000
	47	8	6.2	E	230	0.40	0.14	EEEFC1E470AP	(6)	1000
	68	8	10.2	F	450	0.30	0.14	EEEFC1E680AP	(6)	500
	100	8	10.2	F	450	0.30	0.14	EEEFC1E101AP	(6)	500
	220	10	10.2	G	670	0.15	0.14	EEEFC1E221AP	(6)	500
	330	10	10.2	G	670	0.15	0.14	EEEFC1E331AP	(6)	500
	470	10	10.2	G	670	0.15	0.14	EEEFC1E471AP	(6)	500
35	1	4	5.4	B	60	3.00	0.12	EEEFC1V1R0AR	(5)	2000
	2.2	4	5.4	B	60	3.00	0.12	EEEFC1V2R2AR	(5)	2000
	3.3	4	5.4	B	60	3.00	0.12	EEEFC1V3R3AR	(5)	2000
	4.7	4	5.4	B	60	3.00	0.12	EEEFC1V4R7AR	(5)	2000
	6.8	5	5.4	C	95	1.80	0.12	EEEFC1V6R8AR	(5)	1000
	10	5	5.4	C	95	1.80	0.12	EEEFC1V100AR	(5)	1000
	22	6.3	5.4	D	140	1.00	0.12	EEEFC1V220AP	(5)	1000
	33	8	6.2	E	230	0.40	0.12	EEEFC1V330AP	(6)	1000
	47	8	6.2	E	230	0.40	0.12	EEEFC1V470AP	(6)	1000
	100	10	10.2	G	670	0.15	0.12	EEEFC1V101AP	(6)	500
	220	10	10.2	G	670	0.15	0.12	EEEFC1V221AP	(6)	500
	330	10	10.2	G	670	0.15	0.12	EEEFC1V331AP	(6)	500

· Please refer to the page of "Reflow Profile" and "The Taping Dimensions".

· When requesting vibration-proof product, please put the last "V" instead to "P"

Surface Mount Type

Series : **FC** Type : **V**

Low impedance



Features

- Endurance : 105 °C 1000 h
- Low impedance (1/2 for HA series)
- Vibration-proof product is available upon request. ($\phi 8$ mm and larger)
- RoHS compliant

Specifications

Category temperature range	-40 °C to +105 °C							
Rated voltage range	6.3 V.DC to 50 V.DC							
Capacitance range	1 μ F to 1500 μ F							
Capacitance tolerance	± 20 % (120 Hz/+20 °C)							
Leakage current	$I \leq 0.01$ CV or 3 (μ A) After 2 minutes (Whichever is greater)							
Dissipation factor (tan δ)	Please see the attached characteristics list							
Characteristics at low temperature	V.DC	6.3	10	16	25	35	50	(Impedance ratio at 120 Hz)
	Z(-25 °C) / Z(+20 °C)	2	2	2	2	2	2	
	Z(-40 °C) / Z(+20 °C)	3	3	3	3	3	3	
Endurance	After applying rated working voltage for 1000 hours at +105 °C ± 2 °C and then being stabilized at +20 °C, Capacitors shall meet the following limits.							
	Capacitance change	Within ± 20 % of the initial value						
	tan δ	≤ 200 % of the initial limit						
Shelf life	After storage for 1000 hours at +105 °C ± 2 °C with no voltage applied and then being stabilized at +20 °C, capacitors shall meet the limits specified in Endurance.(With voltage treatment)							
	After reflow soldering and then being stabilized at +20 °C, capacitor shall meet the following limits.							
Resistance to soldering heat	Capacitance change	Within ± 10 % of the initial value						
	tan δ	Within the initial limit						
	DC leakage current	Within the initial limit						
AEC-Q200	AEC-Q200 compliant							

Frequency correction factor for ripple current

Frequency (Hz)	50, 60	120	1 k	10 k	100 k to
Correction factor	0.70	0.75	0.90	0.95	1.00

Marking

Example : 6.3 V.DC 22 μ F
Marking color : BLACK

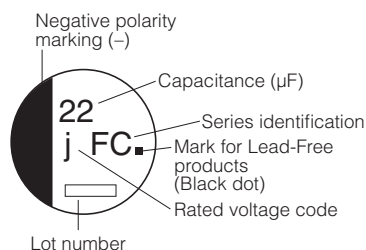

R. Voltage (V.DC)	6.3	10	16	25	35	50
Code	j	A	C	E	V	H

Dimensions

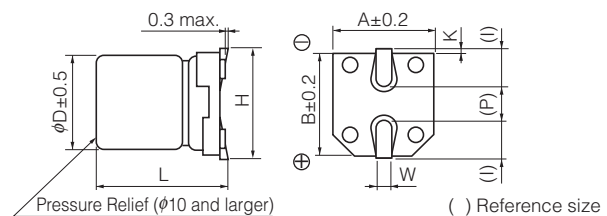

() Reference size

Size code	ϕD	L	A, B	H	I	W	P	K
B	4.0	$5.4^{+0.1}_{-0.2}$	4.3	5.5 max.	1.8	0.65 ± 0.1	1.0	$0.35^{+0.15}_{-0.20}$
C	5.0	$5.4^{+0.1}_{-0.2}$	5.3	6.5 max.	2.2	0.65 ± 0.1	1.5	$0.35^{+0.15}_{-0.20}$
D	6.3	$5.4^{+0.1}_{-0.2}$	6.6	7.8 max.	2.6	0.65 ± 0.1	1.8	$0.35^{+0.15}_{-0.20}$
E	8.0	6.2 ± 0.3	8.3	9.5 max.	3.4	0.65 ± 0.1	2.2	$0.35^{+0.15}_{-0.20}$
F	8.0	10.2 ± 0.3	8.3	10.0 max.	3.4	0.90 ± 0.2	3.1	0.70 ± 0.2
G	10.0	10.2 ± 0.3	10.3	12.0 max.	3.5	0.90 ± 0.2	4.6	0.70 ± 0.2

Characteristics list

Endurance : 105 °C 1000 h

Rated voltage (V.DC)	Cap. (±20 %) (μF)	Case size (mm)		Size code	Specification			Part No.	Reflow	Min. Packaging Qty	
		φD	L		Ripple current (100 kHz) (+105 °C) (mA r.m.s.)	Impedance (100 kHz) (+20 °C) (Ω)	tan δ (120 Hz) (+20 °C)			Taping (pcs)	
6.3	22	4	5.4	B	60	3.00	0.26	EEEF0J220R	(1)	2000	
	47	5	5.4	C	95	1.80	0.26	EEEF0J470R	(1)	1000	
	68	6.3	5.4	D	140	1.00	0.26	EEEF0J680P	(1)	1000	
	100	6.3	5.4	D	140	1.00	0.26	EEEF0J101P	(1)	1000	
	220	8	6.2	E	230	0.40	0.26	EEEF0J221P	(2)	1000	
	330	8	10.2	F	450	0.30	0.26	EEEF0J331P	(2)	500	
	1000	10	10.2	G	670	0.15	0.26	EEEF0J102P	(2)	500	
	1500	10	10.2	G	670	0.15	0.26	EEEF0J152P	(2)	500	
10	33	5	5.4	C	95	1.80	0.19	EEEF1A330R	(1)	1000	
	100	8	6.2	E	230	0.40	0.19	EEEF1A101P	(2)	1000	
	150	8	6.2	E	230	0.40	0.19	EEEF1A151P	(2)	1000	
	220	8	10.2	F	450	0.30	0.19	EEEF1A221P	(2)	500	
	470	10	10.2	G	670	0.15	0.19	EEEF1A471P	(2)	500	
	1000	10	10.2	G	670	0.15	0.19	EEEF1A102P	(2)	500	
16	10	4	5.4	B	60	3.00	0.16	EEEF1C100R	(1)	2000	
	22	5	5.4	C	95	1.80	0.16	EEEF1C220R	(1)	1000	
	47	6.3	5.4	D	140	1.00	0.16	EEEF1C470P	(1)	1000	
	68	8	6.2	E	230	0.40	0.16	EEEF1C680P	(2)	1000	
	100	8	6.2	E	230	0.40	0.16	EEEF1C101P	(2)	1000	
	220	10	10.2	G	670	0.15	0.16	EEEF1C221P	(2)	500	
	330	10	10.2	G	670	0.15	0.16	EEEF1C331P	(2)	500	
	470	10	10.2	G	670	0.15	0.16	EEEF1C471P	(2)	500	
	680	10	10.2	G	670	0.15	0.16	EEEF1C681P	(2)	500	
25	6.8	4	5.4	B	60	3.00	0.14	EEEF1E68R	(1)	2000	
	22	6.3	5.4	D	140	1.00	0.14	EEEF1E220P	(1)	1000	
	33	6.3	5.4	D	140	1.00	0.14	EEEF1E330P	(1)	1000	
	47	8	6.2	E	230	0.40	0.14	EEEF1E470P	(2)	1000	
	68	8	10.2	F	450	0.30	0.14	EEEF1E680P	(2)	500	
	100	8	10.2	F	450	0.30	0.14	EEEF1E101P	(2)	500	
	220	10	10.2	G	670	0.15	0.14	EEEF1E221P	(2)	500	
	330	10	10.2	G	670	0.15	0.14	EEEF1E331P	(2)	500	
	470	10	10.2	G	670	0.15	0.14	EEEF1E471P	(2)	500	
35	1	4	5.4	B	60	3.00	0.12	EEEF1V1R0R	(1)	2000	
	2.2	4	5.4	B	60	3.00	0.12	EEEF1V2R2R	(1)	2000	
	3.3	4	5.4	B	60	3.00	0.12	EEEF1V3R3R	(1)	2000	
	4.7	4	5.4	B	60	3.00	0.12	EEEF1V4R7R	(1)	2000	
	6.8	5	5.4	C	95	1.80	0.12	EEEF1V6R8R	(1)	1000	
	10	5	5.4	C	95	1.80	0.12	EEEF1V100R	(1)	1000	
	22	6.3	5.4	D	140	1.00	0.12	EEEF1V220P	(1)	1000	
	33	8	6.2	E	230	0.40	0.12	EEEF1V330P	(2)	1000	
	47	8	6.2	E	230	0.40	0.12	EEEF1V470P	(2)	1000	
	100	10	10.2	G	670	0.15	0.12	EEEF1V101P	(2)	500	
	220	10	10.2	G	670	0.15	0.12	EEEF1V221P	(2)	500	
	330	10	10.2	G	670	0.15	0.12	EEEF1V331P	(2)	500	
50	1	4	5.4	B	30	5.00	0.12	EEEF1H1R0R	(1)	2000	
	2.2	4	5.4	B	30	5.00	0.12	EEEF1H2R2R	(1)	2000	
	3.3	4	5.4	B	30	5.00	0.12	EEEF1H3R3R	(1)	2000	
	4.7	5	5.4	C	50	3.00	0.12	EEEF1H4R7R	(1)	1000	
	10	6.3	5.4	D	70	2.00	0.12	EEEF1H100P	(1)	1000	
	22	8	6.2	E	120	0.70	0.12	EEEF1H220P	(2)	1000	
	33	8	10.2	F	300	0.60	0.12	EEEF1H330P	(2)	500	
	47	10	10.2	G	500	0.30	0.12	EEEF1H470P	(2)	500	
	100	10	10.2	G	500	0.30	0.12	EEEF1H101P	(2)	500	
	220	10	10.2	G	500	0.30	0.12	EEEF1H221P	(2)	500	

- Please refer to the page of "Reflow Profile" and "The Taping Dimensions".
- When requesting vibration-proof product, please put the last "V" instead to "P"

Surface Mount Type

Series : **FK** Type : **V**
High temperature
Lead-Free reflow (suffix : A*)



Features

- Endurance : 105 °C 2000 h
- Low impedance (40 % to 60 % less than FC series)
 Miniaturized (30 % to 50 % less than FC series)
- Vibration-proof product is available upon request. ($\phi 8$ mm and larger)
- RoHS compliant

Specifications

Category temperature range	-55 °C to +105 °C						
Rated voltage range	6.3 V.DC to 35 V.DC						
Capacitance range	4.7 μ F to 1500 μ F						
Capacitance tolerance	± 20 % (120 Hz/+20 °C)						
Leakage current	$I \leq 0.01 CV$ or 3 (μ A) After 2 minutes (Whichever is greater)						
Dissipation factor (tan δ)	Please see the attached characteristics list						
Characteristics at low temperature	V.DC	6.3	10	16	25	35	(Impedance ratio at 120 Hz)
	Z(-25 °C)/Z(+20 °C)	2	2	2	2	2	
	Z(-40 °C)/Z(+20 °C)	3	3	3	3	3	
	Z(-55 °C)/Z(+20 °C)	4	4	4	3	3	
Endurance	After applying rated working voltage for 2000 hours at +105 °C ± 2 °C and then being stabilized at +20 °C, Capacitors shall meet the following limits.						
	Capacitance change	Within ± 30 % of the initial value					
	tan δ	≤ 200 % of the initial limit					
	DC leakage current	Within the initial limit					
Shelf life	After storage for 1000 hours at +105 °C ± 2 °C with no voltage applied and then being stabilized at +20 °C, capacitors shall meet the limits specified in Endurance. (With voltage treatment)						
Resistance to soldering heat	After reflow soldering and then being stabilized at +20 °C, capacitor shall meet the following limits.						
	Capacitance change	Within ± 10 % of the initial value					
	tan δ	Within the initial limit					
	DC leakage current	Within the initial limit					
AEC-Q200	AEC-Q200 compliant						

Frequency correction factor for ripple current

Capacitance (μ F)	Frequency (Hz)			
	120	1 k	10 k	100 k to
4.7 to 470	0.65	0.85	0.95	1.00
680 to 1500	0.70	0.90	0.95	1.00

Marking

Example : 6.3 V.DC 22 μ F
 Marking color : BLACK

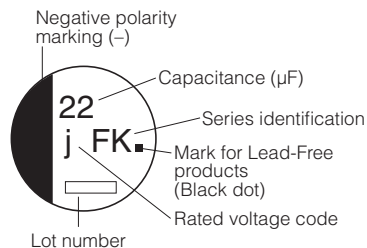

R. Voltage (V.DC)	6.3	10	16	25	35
Code	j	A	C	E	V

Dimensions

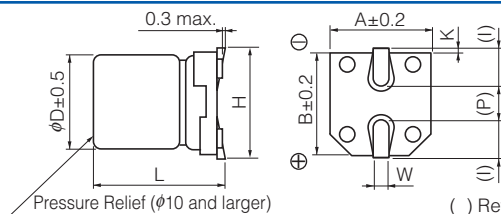

Size code	ϕD	L	A, B	H	I	W	P	K
B	4.0	5.8 ± 0.3	4.3	5.5 max.	1.8	0.65 ± 0.1	1.0	0.35 $^{+0.15}_{-0.20}$
C	5.0	5.8 ± 0.3	5.3	6.5 max.	2.2	0.65 ± 0.1	1.5	0.35 $^{+0.15}_{-0.20}$
D	6.3	5.8 ± 0.3	6.6	7.8 max.	2.6	0.65 ± 0.1	1.8	0.35 $^{+0.15}_{-0.20}$
D8	6.3	7.7 ± 0.3	6.6	7.8 max.	2.6	0.65 ± 0.1	1.8	0.35 $^{+0.15}_{-0.20}$
E	8.0	6.2 ± 0.3	8.3	9.5 max.	3.4	0.65 ± 0.1	2.2	0.35 $^{+0.15}_{-0.20}$
F	8.0	10.2 ± 0.3	8.3	10.0 max.	3.4	0.90 ± 0.2	3.1	0.70 ± 0.20
G	10.0	10.2 ± 0.3	10.3	12.0 max.	3.5	0.90 ± 0.2	4.6	0.70 ± 0.20

Characteristics list

Endurance : 105 °C 2000 h

Rated voltage (V.DC)	Cap. (±20 %) (μF)	Case size (mm)		Size* code	Specification			Part No.	Reflow	Min. Packaging Qty
		φD	L		Ripple current (100 kHz) (+105 °C) (mA r.m.s.)	Impedance (100 kHz) (+20 °C) (Ω)	tan δ (120 Hz) (+20 °C)			Taping (pcs)
6.3	22	4	5.8	B	90	1.35	0.26	EEEFK0J220AR	(5)	2000
	47	4	5.8	(B)	90	1.35	0.26	EEEFKJ470UAR	(5)	2000
		5	5.8	C	160	0.70	0.26	EEEFK0J470AR	(5)	1000
	100	5	5.8	(C)	160	0.70	0.26	EEEFKJ101UAR	(5)	1000
		6.3	5.8	D	240	0.36	0.26	EEEFK0J101AP	(5)	1000
	220	6.3	5.8	D	240	0.36	0.26	EEEFK0J221AP	(5)	1000
	330	6.3	7.7	D8	280	0.34	0.26	EEEFKJ331XAP	(5)	900
		8	6.2	E	300	0.26	0.26	EEEFK0J331AP	(6)	1000
	470	8	10.2	F	600	0.16	0.26	EEEFK0J471AP	(6)	500
1000	8	10.2	F	600	0.16	0.26	EEEFK0J102AP	(6)	500	
1500	10	10.2	G	850	0.08	0.26	EEEFK0J152AP	(6)	500	
10	22	4	5.8	B	90	1.35	0.19	EEEFK1A220AR	(5)	2000
	33	4	5.8	(B)	90	1.35	0.19	EEEFKA330UAR	(5)	2000
		5	5.8	C	160	0.70	0.19	EEEFK1A330AR	(5)	1000
	150	6.3	5.8	D	240	0.36	0.19	EEEFK1A151AP	(5)	1000
		6.3	7.7	D8	280	0.34	0.19	EEEFKA221XAP	(5)	900
	220	8	6.2	E	300	0.26	0.19	EEEFK1A221AP	(6)	1000
		330	8	10.2	F	600	0.16	0.19	EEEFK1A331AP	(6)
	470	8	10.2	F	600	0.16	0.19	EEEFK1A471AP	(6)	500
	680	8	10.2	F	600	0.16	0.19	EEEFK1A681AP	(6)	500
1000	10	10.2	G	850	0.08	0.19	EEEFK1A102AP	(6)	500	
16	10	4	5.8	B	90	1.35	0.16	EEEFK1C100AR	(5)	2000
	22	4	5.8	(B)	90	1.35	0.16	EEEFKC220UAR	(5)	2000
		5	5.8	C	160	0.70	0.16	EEEFK1C220AR	(5)	1000
	47	5	5.8	(C)	160	0.70	0.16	EEEFKC470UAR	(5)	1000
		6.3	5.8	D	240	0.36	0.16	EEEFK1C470AP	(5)	1000
	68	6.3	5.8	D	240	0.36	0.16	EEEFK1C680AP	(5)	1000
	100	6.3	5.8	D	240	0.36	0.16	EEEFK1C101AP	(5)	1000
	150	6.3	7.7	D8	280	0.34	0.16	EEEFKC151XAP	(5)	900
		6.3	7.7	D8	280	0.34	0.16	EEEFKC221XAP	(5)	900
	220	8	6.2	E	300	0.26	0.16	EEEFK1C221AP	(6)	1000
		330	8	10.2	F	600	0.16	0.16	EEEFK1C331AP	(6)
470	8	10.2	F	600	0.16	0.16	EEEFK1C471AP	(6)	500	
680	10	10.2	G	850	0.08	0.16	EEEFK1C681AP	(6)	500	
25	10	4	5.8	B	90	1.35	0.14	EEEFK1E100AR	(5)	2000
	22	5	5.8	C	160	0.70	0.14	EEEFK1E220AR	(5)	1000
		5	5.8	(C)	160	0.70	0.14	EEEFKE330UAR	(5)	1000
	33	6.3	5.8	D	240	0.36	0.14	EEEFK1E330AP	(5)	1000
		47	6.3	5.8	D	240	0.36	0.14	EEEFK1E470AP	(5)
	68	6.3	5.8	D	240	0.36	0.14	EEEFK1E680AP	(5)	1000
	100	6.3	7.7	D8	280	0.34	0.14	EEEFKE101XAP	(5)	900
		8	6.2	E	300	0.26	0.14	EEEFK1E101AP	(6)	1000
	150	8	10.2	F	600	0.16	0.14	EEEFK1E151AP	(6)	500
	220	8	10.2	F	600	0.16	0.14	EEEFK1E221AP	(6)	500
	330	8	10.2	F	600	0.16	0.14	EEEFK1E331AP	(6)	500
	470	10	10.2	G	850	0.08	0.14	EEEFK1E471AP	(6)	500
	35	4.7	4	5.8	B	90	1.35	0.12	EEEFK1V4R7AR	(5)
10		4	5.8	(B)	90	1.35	0.12	EEEFKV100UAR	(5)	2000
		5	5.8	C	160	0.70	0.12	EEEFK1V100AR	(5)	1000
22		5	5.8	C	160	0.70	0.12	EEEFK1V220AR	(5)	1000
33		6.3	5.8	D	240	0.36	0.12	EEEFK1V330AP	(5)	1000
47		6.3	5.8	D	240	0.36	0.12	EEEFK1V470AP	(5)	1000
68		6.3	7.7	D8	280	0.34	0.12	EEEFKV680XAP	(5)	900
		6.3	7.7	D8	280	0.34	0.12	EEEFKV101XAP	(5)	900
100		8	10.2	F	600	0.16	0.12	EEEFK1V101AP	(6)	500
		150	8	10.2	F	600	0.16	0.12	EEEFK1V151AP	(6)
220		8	10.2	F	600	0.16	0.12	EEEFK1V221AP	(6)	500
330	10	10.2	G	850	0.08	0.12	EEEFK1V331AP	(6)	500	

* Size code() : Miniaturization product
 If Part number exceeds 12 digits, voltage code is abbreviated as follows; 0J → J, 1A → A, 1C → C, 1E → E, 1V → V
 · Please refer to the page of "Reflow Profile" and "The Taping Dimensions".
 · When requesting vibration-proof product, please put the last "V" instead of "P"

Surface Mount Type

Series : Medium-size **FK** Type : **V**

High temperature

Lead-Free reflow (suffix : A*)

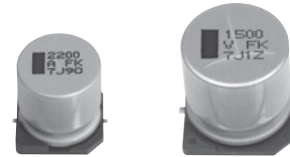

Features

- Endurance : 105 °C 5000 h
- Vibration-proof product is available upon request.
- RoHS compliant

Specifications

Category temperature range	-55 °C to +105 °C										
Rated voltage range	6.3 V.DC to 100 V.DC										
Capacitance range	47 μF to 6800 μF										
Capacitance tolerance	±20 % (120 Hz/+20 °C)										
Leakage current	I ≤ 0.01 CV (μA) After 2 minutes										
Dissipation factor (tan δ)	Please see the attached characteristics list										
Characteristics at low temperature	V.DC	6.3	10	16	25	35	50	63	80	100	(Impedance ratio at 120 Hz)
	Z(-25 °C)/Z(+20 °C)	2	2	2	2	2	2	2	2	2	
	Z(-40 °C)/Z(+20 °C)	3	3	3	3	3	3	3	3	3	
	Z(-55 °C)/Z(+20 °C)	4	4	4	3	3	3	3	3	3	
Endurance	After applying rated working voltage for 5000 hours at +105 °C±2 °C and then being stabilized at +20 °C, Capacitors shall meet the following limits.										
	Capacitance change	Within ±30 % of the initial value									
	tan δ	≤200 % of the initial limit									
Shelf life	After storage for 1000 hours at +105 °C±2 °C with no voltage applied and then being stabilized at +20 °C, capacitors shall meet the limits specified in Endurance (With voltage treatment)										
	After reflow soldering and then being stabilized at +20 °C, capacitors shall meet the following limits.										
Resistance to soldering heat	Capacitance change	Within ±10 % of the initial value									
	tan δ	Within the initial limit									
	DC leakage current	Within the initial limit									
AEC-Q200	AEC-Q200 compliant										

Frequency correction factor for ripple current

Frequency (Hz)	120	1 k	10 k	100 k to
Correction factor	0.75	0.90	0.95	1.00

Marking

Example : 6.3 V.DC 3300 μF
Marking color : BLACK

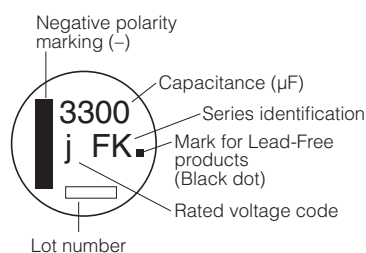

R. Voltage (V.DC)	6.3	10	16	25	35	50	63	80	100
Code	j	A	C	E	V	H	J	K	2A

Dimensions

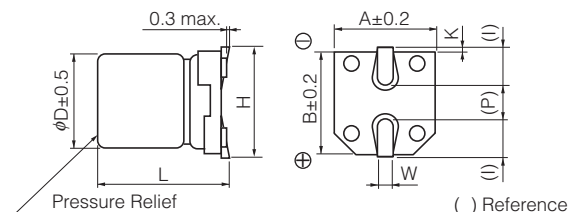

(Unit : mm)

Size code	φD	L	A, B	H	I	W	P	K
H13	12.5	13.5±0.5	13.5	15.0 max.	4.7	0.90±0.3	4.4	0.70±0.30
J16	16.0	16.5±0.5	17.0	19.0 max.	5.5	1.20±0.3	6.7	0.70±0.30
K16	18.0	16.5±0.5	19.0	21.0 max.	6.7	1.20±0.3	6.7	0.70±0.30

Characteristics list

Endurance : 105 °C 5000 h

Rated voltage (V.DC)	Cap. (±20 %) (μF)	Case size (mm)		Size code	Specification			Part No.	Reflow	Min. Packaging Qty	
		φD	L		Ripple current (100 kHz) (+105 °C) (mA r.m.s.)	Impedance (100 kHz) (+20 °C) (Ω)	tan δ (120 Hz) (+20 °C)			Taping (pcs)	
6.3	3300	12.5	13.5	H13	1100	0.06	0.30	EEEFK0J332AQ	(9)	200	
	6800	16	16.5	J16	1800	0.035	0.36	EEEFK0J682AM	(9)	125	
10	2200	12.5	13.5	H13	1100	0.06	0.21	EEEFK1A222AQ	(9)	200	
	4700	16	16.5	J16	1800	0.035	0.25	EEEFK1A472AM	(9)	125	
	6800	18	16.5	K16	2060	0.033	0.29	EEEFK1A682AM	(9)	125	
16	1500	12.5	13.5	H13	1100	0.06	0.16	EEEFK1C152AQ	(9)	200	
	3300	16	16.5	J16	1800	0.035	0.20	EEEFK1C332AM	(9)	125	
	4700	18	16.5	K16	2060	0.033	0.22	EEEFK1C472AM	(9)	125	
25	1000	12.5	13.5	H13	1100	0.06	0.14	EEEFK1E102AQ	(9)	200	
	1500	16	16.5	J16	1800	0.035	0.16	EEEFK1E152AM	(9)	125	
	2200	16	16.5	J16	1800	0.035	0.16	EEEFK1E222AM	(9)	125	
	3300	18	16.5	K16	2060	0.033	0.18	EEEFK1E332AM	(9)	125	
35	470	12.5	13.5	H13	1100	0.06	0.12	EEEFK1V471AQ	(9)	200	
	680	12.5	13.5	H13	1100	0.06	0.12	EEEFK1V681AQ	(9)	200	
	1000	16	16.5	J16	1800	0.035	0.12	EEEFK1V102AM	(9)	125	
	1500	16	16.5	J16	1800	0.035	0.12	EEEFK1V152AM	(9)	125	
50	330	12.5	13.5	H13	900	0.12	0.12	EEEFK1H331AQ	(10)	200	
	390	12.5	13.5	H13	900	0.12	0.12	EEEFK1H391AQ	(10)	200	
	470	16	16.5	J16	1610	0.073	0.12	EEEFK1H471AM	(10)	125	
	560	16	16.5	J16	1610	0.073	0.12	EEEFK1H561AM	(10)	125	
	680	16	16.5	J16	1610	0.073	0.12	EEEFK1H681AM	(10)	125	
	1000	16	16.5	J16	1610	0.073	0.12	EEEFK1H102AM	(10)	125	
63	150	12.5	13.5	H13	800	0.16	0.10	EEEFK1J151AQ	(10)	200	
	220	12.5	13.5	H13	800	0.16	0.10	EEEFK1J221AQ	(10)	200	
	470	16	16.5	J16	1410	0.082	0.10	EEEFK1J471AM	(10)	125	
	680	18	16.5	K16	1690	0.08	0.10	EEEFK1J681AM	(10)	125	
80	68	12.5	13.5	H13	500	0.32	0.08	EEEFK1K680AQ	(11)	200	
	100	12.5	13.5	H13	500	0.32	0.08	EEEFK1K101AQ	(11)	200	
	150	12.5	13.5	H13	500	0.32	0.08	EEEFK1K151AQ	(11)	200	
	330	16	16.5	J16	793	0.17	0.08	EEEFK1K331AM	(11)	125	
	470	18	16.5	K16	917	0.153	0.08	EEEFK1K471AM	(11)	125	
100	47	12.5	13.5	H13	500	0.32	0.07	EEEFK2A470AQ	(11)	200	
	68	12.5	13.5	H13	500	0.32	0.07	EEEFK2A680AQ	(11)	200	
	100	16	16.5	J16	793	0.17	0.07	EEEFK2A101AM	(11)	125	
	150	16	16.5	J16	793	0.17	0.07	EEEFK2A151AM	(11)	125	
	220	18	16.5	K16	917	0.153	0.07	EEEFK2A221AM	(11)	125	
	330	18	16.5	K16	917	0.153	0.07	EEEFK2A331AM	(11)	125	

· Please refer to the page of "Reflow Profile" and "The Taping Dimensions".
 · When requesting vibration-proof product, please put the last "V" instead to "Q" or "M"

Surface Mount Type

Series : **FK** Type : **V**



Features

- Endurance : 105 °C 2000 h to 5000 h
- Low impedance (40 % to 60 % less than FC series)
Miniaturized (30 % to 50 % less than FC series)
- Vibration-proof product is available upon request. ($\phi 8$ mm and larger)
- RoHS compliant

Specifications

Category temperature range	-55 °C to +105 °C										
Rated voltage range	6.3 V.DC to 100 V.DC										
Capacitance range	3.3 μ F to 6800 μ F										
Capacitance tolerance	$\pm 20\%$ (120 Hz/+20 °C)										
Leakage current	$I \leq 0.01$ CV or 3 (μ A) After 2 minutes (Whichever is greater)										
Dissipation factor ($\tan \delta$)	Please see the attached characteristics list										
Characteristics at low temperature	V.DC	6.3	10	16	25	35	50	63	80	100	(Impedance ratio at 120 Hz)
	Z(-25 °C)/Z(+20 °C)	2	2	2	2	2	2	2	2	2	
	Z(-40 °C)/Z(+20 °C)	3	3	3	3	3	3	3	3	3	
	Z(-55 °C)/Z(+20 °C)	4	4	4	3	3	3	3	3	3	
Endurance	After applying rated working voltage for 2000 hours at +105 °C ± 2 °C and then being stabilized at +20 °C, Capacitors shall meet the following limits. ($\geq \phi 12.5$ and suffix "G" in $\phi 8 \times 10.2$, $\phi 10 \times 10.2$ are 5000 hours)										
	Capacitance change	Within $\pm 30\%$ of the initial value (Suffix "G" is 35 %)									
	$\tan \delta$	$\leq 200\%$ of the initial limit (Suffix "G" is 300 %)									
Shelf life	After storage for 1000 hours at +105 °C ± 2 °C with no voltage applied and then being stabilized at +20 °C, capacitors shall meet the limits specified in Endurance (With voltage treatment)										
	After reflow soldering and then being stabilized at +20 °C, capacitors shall meet the following limits.										
Resistance to soldering heat	Capacitance change	Within $\pm 10\%$ of the initial value									
	$\tan \delta$	Within the initial limit									
	DC leakage current	Within the initial limit									
AEC-Q200	AEC-Q200 compliant										

Frequency correction factor for ripple current

Frequency (Hz)	50, 60	120	1 k	10 k	100 k to
Correction factor	0.70	0.75	0.90	0.95	1.00

Marking

Example : 6.3 V.DC 22 μ F, 6.3 V.DC 3300 μ F
Marking color : BLACK
 $\leq \phi 10$

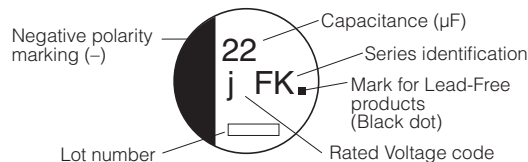

$\geq \phi 12.5$

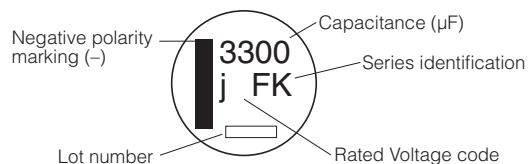

R. Voltage (V.DC)	6.3	10	16	25	35	50	63	80	100
Code	j	A	C	E	V	H	J	K	2A

Dimensions

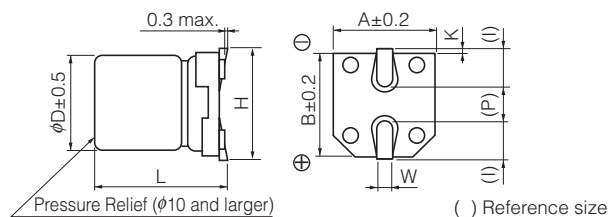

(Unit : mm)

Size code	ϕD	L	A, B	H	I	W	P	K
B	4.0	5.8 ± 0.3	4.3	5.5 max.	1.8	0.65 ± 0.1	1.0	0.35 $^{+0.05}_{-0.2}$
C	5.0	5.8 ± 0.3	5.3	6.5 max.	2.2	0.65 ± 0.1	1.5	0.35 $^{+0.05}_{-0.2}$
D	6.3	5.8 ± 0.3	6.6	7.8 max.	2.6	0.65 ± 0.1	1.8	0.35 $^{+0.05}_{-0.2}$
D8	6.3	7.7 ± 0.3	6.6	7.8 max.	2.6	0.65 ± 0.1	1.8	0.35 $^{+0.05}_{-0.2}$
E	8.0	6.2 ± 0.3	8.3	9.5 max.	3.4	0.65 ± 0.1	2.2	0.35 $^{+0.05}_{-0.2}$
F	8.0	10.2 ± 0.3	8.3	10.0 max.	3.4	0.90 ± 0.2	3.1	0.70 ± 0.2
G	10.0	10.2 ± 0.3	10.3	12.0 max.	3.5	0.90 ± 0.2	4.6	0.70 ± 0.2
H13	12.5	13.5 ± 0.5	13.5	15.0 max.	4.7	0.90 ± 0.3	4.4	0.70 ± 0.3
J16	16.0	16.5 ± 0.5	17.0	19.0 max.	5.5	1.20 ± 0.3	6.7	0.70 ± 0.3
K16	18.0	16.5 ± 0.5	19.0	21.0 max.	6.7	1.20 ± 0.3	6.7	0.70 ± 0.3

Characteristics list

Endurance : 105 °C 2000 h (≥ φ12.5 : 5000 h)

Rated voltage (V.DC)	Cap. (±20 %) (μF)	Case size (mm)		Size* code	Specification			Part No.	Reflow	Min. Packaging Qty
		φD	L		Ripple current (100 kHz) (+105 °C) (mA r.m.s.)	Impedance (100 kHz) (+20 °C) (Ω)	tan δ (120 Hz) (+20 °C)			Taping (pcs)
6.3	22	4	5.8	B	90	1.35	0.26	EEEFK0J220R	(1)	2000
	47	4	5.8	(B)	90	1.35	0.26	EEEFK0J470UR	(1)	2000
		5	5.8	C	160	0.70	0.26	EEEFK0J470R	(1)	1000
	100	5	5.8	(C)	160	0.70	0.26	EEEFK0J101UR	(1)	1000
		6.3	5.8	D	240	0.36	0.26	EEEFK0J101P	(1)	1000
	220	6.3	5.8	D	240	0.36	0.26	EEEFK0J221P	(1)	1000
	330	6.3	7.7	D8	280	0.34	0.26	EEEFK0J331XP	(1)	900
		8	6.2	E	300	0.26	0.26	EEEFK0J331P	(2)	1000
	470	8	10.2	F	600	0.16	0.26	EEEFK0J471P	(2)	500
	1000	8	10.2	F	600	0.16	0.26	EEEFK0J102P	(2)	500
	1500	10	10.2	G	850	0.08	0.26	EEEFK0J152P	(2)	500
3300	12.5	13.5	H13	1100	0.06	0.30	EEVFK0J332Q	(3)	200	
6800	16	16.5	J16	1800	0.035	0.36	EEVFK0J682M	(3)	125	
10	22	4	5.8	B	90	1.35	0.19	EEEFK1A220R	(1)	2000
	33	4	5.8	(B)	90	1.35	0.19	EEEFK1A330UR	(1)	2000
		5	5.8	C	160	0.70	0.19	EEEFK1A330R	(1)	1000
	150	6.3	5.8	D	240	0.36	0.19	EEEFK1A151P	(1)	1000
	220	6.3	7.7	D8	280	0.34	0.19	EEEFK1A221XP	(1)	900
		8	6.2	E	300	0.26	0.19	EEEFK1A221P	(2)	1000
	330	8	10.2	F	600	0.16	0.19	EEEFK1A331P	(2)	500
	470	8	10.2	F	600	0.16	0.19	EEEFK1A471P	(2)	500
	680	8	10.2	F	600	0.16	0.19	EEEFK1A681P	(2)	500
	1000	10	10.2	G	850	0.08	0.19	EEEFK1A102P	(2)	500
	2200	12.5	13.5	H13	1100	0.06	0.21	EEVFK1A222Q	(3)	200
4700	16	16.5	J16	1800	0.035	0.25	EEVFK1A472M	(3)	125	
6800	18	16.5	K16	2060	0.033	0.29	EEVFK1A682M	(3)	125	
16	10	4	5.8	B	90	1.35	0.16	EEEFK1C100R	(1)	2000
	22	4	5.8	(B)	90	1.35	0.16	EEEFK1C220UR	(1)	2000
		5	5.8	C	160	0.70	0.16	EEEFK1C220R	(1)	1000
	47	5	5.8	(C)	160	0.70	0.16	EEEFK1C470UR	(1)	1000
		6.3	5.8	D	240	0.36	0.16	EEEFK1C470P	(1)	1000
	68	6.3	5.8	D	240	0.36	0.16	EEEFK1C680P	(1)	1000
	100	6.3	5.8	D	240	0.36	0.16	EEEFK1C101P	(1)	1000
	150	6.3	7.7	D8	280	0.34	0.16	EEEFK1C151XP	(1)	900
		6.3	7.7	D8	280	0.34	0.16	EEEFK1C221XP	(1)	900
	220	8	6.2	E	300	0.26	0.16	EEEFK1C221P	(2)	1000
		330	8	10.2	F	600	0.16	0.16	EEEFK1C331P	(2)
	470	8	10.2	F	600	0.16	0.16	EEEFK1C471P	(2)	500
	680	10	10.2	G	850	0.08	0.16	EEEFK1C681P	(2)	500
	1500	12.5	13.5	H13	1100	0.06	0.16	EEVFK1C152Q	(3)	200
3300	16	16.5	J16	1800	0.035	0.20	EEVFK1C332M	(3)	125	
4700	18	16.5	K16	2060	0.033	0.22	EEVFK1C472M	(3)	125	
25	10	4	5.8	B	90	1.35	0.14	EEEFK1E100R	(1)	2000
	22	5	5.8	C	160	0.70	0.14	EEEFK1E220R	(1)	1000
		5	5.8	(C)	160	0.70	0.14	EEEFK1E330UR	(1)	1000
	33	6.3	5.8	D	240	0.36	0.14	EEEFK1E330P	(1)	1000
		47	6.3	5.8	D	240	0.36	0.14	EEEFK1E470P	(1)
	68	6.3	5.8	D	240	0.36	0.14	EEEFK1E680P	(1)	1000
	100	6.3	7.7	D8	280	0.34	0.14	EEEFK1E101XP	(1)	900
		8	6.2	E	300	0.26	0.14	EEEFK1E101P	(2)	1000
	150	8	10.2	F	600	0.16	0.14	EEEFK1E151P	(2)	500
	220	8	10.2	F	600	0.16	0.14	EEEFK1E221P	(2)	500
	330	8	10.2	F	600	0.16	0.14	EEEFK1E331P	(2)	500
	470	10	10.2	G	850	0.08	0.14	EEEFK1E471P	(2)	500
	1000	12.5	13.5	H13	1100	0.06	0.14	EEVFK1E102Q	(3)	200
	1500	16	16.5	J16	1800	0.035	0.14	EEVFK1E152M	(3)	125
	2200	16	16.5	J16	1800	0.035	0.16	EEVFK1E222M	(3)	125
3300	18	16.5	K16	2060	0.033	0.18	EEVFK1E332M	(3)	125	

* Size code() : Miniaturization product

· Please refer to the page of "Reflow Profile" and "The Taping Dimensions".

· When requesting vibration-proof product, please put the last "V" instead to "P"

Design and specifications are each subject to change without notice. Ask factory for the current technical specifications before purchase and/or use.

Should a safety concern arise regarding this product, please be sure to contact us immediately.

Characteristics list

Endurance : 105 °C 2000 h (≥ φ12.5 : 5000 h)

Rated voltage (V.DC)	Cap. (±20 %) (μF)	Case size (mm)		Size* code	Specification			Part No.	Reflow	Min. Packaging Qty
		φD	L		Ripple current (100 kHz) (+105 °C) (mA r.m.s.)	Impedance (100 kHz) (+20 °C) (Ω)	tan δ (120 Hz) (+20 °C)			Taping (pcs)
35	4.7	4	5.8	B	90	1.35	0.12	EEEFK1V4R7R	(1)	2000
	10	4	5.8	(B)	90	1.35	0.12	EEEFK1V100UR	(1)	2000
		5	5.8	C	160	0.70	0.12	EEEFK1V100R	(1)	1000
	22	5	5.8	C	160	0.70	0.12	EEEFK1V220R	(1)	1000
	33	6.3	5.8	D	240	0.36	0.12	EEEFK1V330P	(1)	1000
	47	6.3	5.8	D	240	0.36	0.12	EEEFK1V470P	(1)	1000
	68	6.3	7.7	D8	280	0.34	0.12	EEEFK1V680XP	(1)	900
	100	6.3	7.7	D8	280	0.34	0.12	EEEFK1V101XP	(1)	900
		8	10.2	F	600	0.16	0.12	EEEFK1V101P	(2)	500
	150	8	10.2	F	600	0.16	0.12	EEEFK1V151P	(2)	500
	220	8	10.2	F	600	0.16	0.12	EEEFK1V221P	(2)	500
	330	10	10.2	G	850	0.08	0.12	EEEFK1V331P	(2)	500
	470	12.5	13.5	H13	1100	0.06	0.12	EEVFK1V471Q	(3)	200
	680	12.5	13.5	H13	1100	0.06	0.12	EEVFK1V681Q	(3)	200
	1000	16	16.5	J16	1800	0.035	0.12	EEVFK1V102M	(3)	125
1500	16	16.5	J16	1800	0.035	0.12	EEVFK1V152M	(3)	125	
50	4.7	4	5.8	B	60	2.90	0.10	EEEFK1H4R7R	(1)	2000
	10	5	5.8	(C)	85	1.52	0.10	EEEFK1H100UR	(1)	1000
		6.3	5.8	D	165	0.88	0.10	EEEFK1H100P	(1)	1000
	22	6.3	5.8	D	165	0.88	0.10	EEEFK1H220P	(1)	1000
	33	6.3	7.7	D8	195	0.68	0.10	EEEFK1H330XP	(1)	900
		8	6.2	E	195	0.68	0.10	EEEFK1H330P	(2)	1000
	47	6.3	7.7	D8	195	0.68	0.10	EEEFK1H470XP	(1)	900
		8	6.2	E	195	0.68	0.10	EEEFK1H470P	(2)	1000
	100	8	10.2	F	350	0.34	0.10	EEEFK1H101P	(2)	500
	150	10	10.2	G	670	0.18	0.10	EEEFK1H151P	(2)	500
	220	10	10.2	G	670	0.18	0.10	EEEFK1H221P	(2)	500
	330	12.5	13.5	H13	900	0.12	0.10	EEVFK1H331Q	(3)	200
	390	12.5	13.5	H13	900	0.12	0.10	EEVFK1H391Q	(3)	200
	470	16	16.5	J16	1610	0.073	0.10	EEVFK1H471M	(3)	125
	560	16	16.5	J16	1610	0.073	0.10	EEVFK1H561M	(3)	125
680	16	16.5	J16	1610	0.073	0.10	EEVFK1H681M	(3)	125	
1000	16	16.5	J16	1610	0.073	0.10	EEVFK1H102M	(3)	125	
63	4.7	5	5.8	C	50	3.00	0.08	EEEFK1J4R7R	(1)	1000
	10	6.3	5.8	D	80	1.50	0.08	EEEFK1J100P	(1)	1000
	22	6.3	7.7	D8	120	1.20	0.08	EEEFK1J220XP	(1)	900
		8	6.2	E	120	1.20	0.08	EEEFK1J220P	(2)	1000
	33	8	10.2	F	250	0.65	0.08	EEEFK1J330P	(2)	500
	47	8	10.2	F	250	0.65	0.08	EEEFK1J470P	(2)	500
	68	8	10.2	(F)	250	0.65	0.08	EEEFK1J680UP	(2)	500
	100	10	10.2	G	400	0.35	0.08	EEEFK1J101P	(2)	500
	150	12.5	13.5	H13	800	0.16	0.08	EEVFK1J151Q	(3)	200
	220	12.5	13.5	H13	800	0.16	0.08	EEVFK1J221Q	(3)	200
	470	16	16.5	J16	1410	0.082	0.08	EEVFK1J471M	(3)	125
	680	18	16.5	K16	1690	0.08	0.08	EEVFK1J681M	(3)	125
80	3.3	5	5.8	C	25	5.00	0.08	EEEFK1K3R3R	(1)	1000
	4.7	6.3	5.8	D	40	3.00	0.08	EEEFK1K4R7P	(1)	1000
		6.3	7.7	D8	60	2.40	0.08	EEEFK1K100XP	(1)	900
	10	8	6.2	E	60	2.40	0.08	EEEFK1K100P	(2)	1000
		8	10.2	F	130	1.30	0.08	EEEFK1K220P	(2)	500
	33	8	10.2	F	130	1.30	0.08	EEEFK1K330P	(2)	500
	47	10	10.2	G	200	0.70	0.08	EEEFK1K470P	(2)	500
	68	12.5	13.5	H13	500	0.32	0.08	EEVFK1K680Q	(3)	200
	100	12.5	13.5	H13	500	0.32	0.08	EEVFK1K101Q	(3)	200
	150	12.5	13.5	H13	500	0.32	0.08	EEVFK1K151Q	(3)	200
	330	16	16.5	J16	793	0.17	0.08	EEVFK1K331M	(3)	125
	470	18	16.5	K16	917	0.153	0.08	EEVFK1K471M	(3)	125

* Size code() : Miniaturization product
 · Please refer to the page of "Reflow Profile" and "The Taping Dimensions".
 · When requesting vibration-proof product, please put the last "V" instead to "P"

Characteristics list

Endurance : 105 °C 2000 h (≥ φ12.5 : 5000 h)

Rated voltage (V.DC)	Cap. (±20 %) (μF)	Case size (mm)		Size* code	Specification			Part No.	Reflow	Min. Packaging Qty	
		φD	L		Ripple current (100 kHz) (+105 °C) (mA r.m.s.)	Impedance (100 kHz) (+20 °C) (Ω)	tan δ (120 Hz) (+20 °C)			Taping (pcs)	
100	22	8	10.2	F	130	1.30	0.07	EEEFK2A220P	(2)	500	
	33	10	10.2	G	200	0.70	0.07	EEEFK2A330P	(2)	500	
	47	12.5	13.5	H13	500	0.32	0.07	EEVFK2A470Q	(3)	200	
	68	12.5	13.5	H13	500	0.32	0.07	EEVFK2A680Q	(3)	200	
	100	16	16.5	J16	793	0.17	0.07	EEVFK2A101M	(3)	125	
	150	16	16.5	J16	793	0.17	0.07	EEVFK2A151M	(3)	125	
	220	18	16.5	K16	917	0.153	0.07	EEVFK2A221M	(3)	125	
	330	18	16.5	K16	917	0.153	0.07	EEVFK2A331M	(3)	125	

* Size code() : Miniaturization product

· Please refer to the page of "Reflow Profile" and "The Taping Dimensions".

Characteristics list

Endurance : 105 °C 5000 h

Rated voltage (V.DC)	Cap. (±20 %) (μF)	Case size (mm)		Size* code	Specification			Part No.	Reflow	Min. Packaging Qty	
		φD	L		Ripple current (100 kHz) (+105 °C) (mA r.m.s.)	Impedance (100 kHz) (+20 °C) (Ω)	tan δ (120 Hz) (+20 °C)			Taping (pcs)	
6.3	470	8	10.2	F	600	0.16	0.26	EEEFK0J471GP	(2)	500	
	1000	8	10.2	F	600	0.16	0.26	EEEFK0J102GP	(2)	500	
	1500	10	10.2	G	850	0.08	0.26	EEEFK0J152GP	(2)	500	
10	330	8	10.2	F	600	0.16	0.19	EEEFK1A331GP	(2)	500	
	470	8	10.2	F	600	0.16	0.19	EEEFK1A471GP	(2)	500	
	680	8	10.2	F	600	0.16	0.19	EEEFK1A681GP	(2)	500	
	1000	10	10.2	G	850	0.08	0.19	EEEFK1A102GP	(2)	500	
16	330	8	10.2	F	600	0.16	0.16	EEEFK1C331GP	(2)	500	
	470	8	10.2	F	600	0.16	0.16	EEEFK1C471GP	(2)	500	
	680	10	10.2	G	850	0.08	0.16	EEEFK1C681GP	(2)	500	
25	150	8	10.2	F	600	0.16	0.14	EEEFK1E151GP	(2)	500	
	220	8	10.2	F	600	0.16	0.14	EEEFK1E221GP	(2)	500	
	330	8	10.2	F	600	0.16	0.14	EEEFK1E331GP	(2)	500	
	470	10	10.2	G	850	0.08	0.14	EEEFK1E471GP	(2)	500	
35	100	8	10.2	F	600	0.16	0.12	EEEFK1V101GP	(2)	500	
	150	8	10.2	F	600	0.16	0.12	EEEFK1V151GP	(2)	500	
	220	8	10.2	F	600	0.16	0.12	EEEFK1V221GP	(2)	500	
	330	10	10.2	G	850	0.08	0.12	EEEFK1V331GP	(2)	500	
50	100	8	10.2	F	350	0.34	0.10	EEEFK1H101GP	(2)	500	
	150	10	10.2	G	670	0.18	0.10	EEEFK1H151GP	(2)	500	
	220	10	10.2	G	670	0.18	0.10	EEEFK1H221GP	(2)	500	

· Please refer to the page of "Reflow Profile" and "The Taping Dimensions".

· When requesting vibration-proof product, please put the last "V" instead to "P"

Surface Mount Type

Series : **FKS** Type : **V**

High temperature Lead-Free reflow



Features

- Endurance : 105 °C 2000 h
- 1 size smaller than series FK
- Vibration-proof product is available upon request. ($\phi 8$ mm and larger)
- RoHS compliant

Specifications

Category temperature range	-55 °C to +105 °C							
Rated voltage range	6.3 V.DC to 50 V.DC							
Capacitance range	10 μ F to 1800 μ F							
Capacitance tolerance	± 20 % (120 Hz/+20 °C)							
Leakage current	$I \leq 0.01$ CV or 3 (μ A) After 2 minutes (Whichever is greater)							
Dissipation factor (tan δ)	Please see the attached characteristics list							
Characteristics at low temperature	V.DC	6.3	10	16	25	35	50	(Impedance ratio at 120 Hz)
	Z(-25 °C)/Z(+20 °C)	2	2	2	2	2	2	
	Z(-40 °C)/Z(+20 °C)	3	3	3	3	3	3	
	Z(-55 °C)/Z(+20 °C)	4	4	4	3	3	3	
Endurance	After applying rated working voltage for 2000 hours at +105 °C ± 2 °C and then being stabilized at +20 °C, capacitors shall meet the following limits.							
	Capacitance change	Within ± 30 % of the initial value (6.3 V.DC of B, C size : Within ± 40 %)						
	tan δ	≤ 200 % of the initial limit						
	DC leakage current	Within the initial limit						
Shelf life	After storage for 1000 hours at +105 °C ± 2 °C with no voltage applied and then being stabilized at +20 °C, capacitors shall meet the limits specified in Endurance. (With voltage treatment)							
Resistance to soldering heat	After reflow soldering and then being stabilized at +20 °C, capacitors shall meet the following limits.							
	Capacitance change	Within ± 10 % of the initial value						
	tan δ	Within the initial limit						
	DC leakage current	Within the initial limit						
AEC-Q200	AEC-Q200 compliant							

Frequency correction factor for ripple current

Frequency (Hz)	120	1 k	10 k	100 k to
Correction factor	0.65	0.85	0.95	1.00

Marking

Example : 6.3 V.DC 270 μ F
Marking color : BLACK

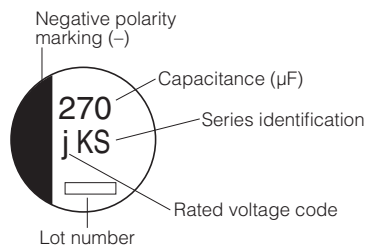

R. Voltage (V.DC)	6.3	10	16	25	35	50
Code	j	A	C	E	V	H

Dimensions

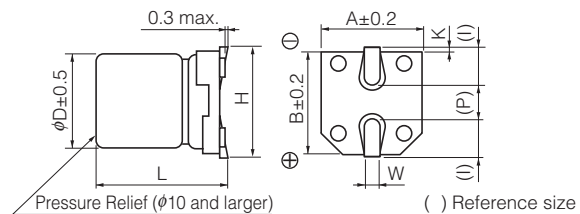

(Unit : mm)

Size code	ϕD	L	A, B	H.	I	W	P	K
B	4.0	5.8 ± 0.3	4.3	5.5 max	1.8	0.65 ± 0.1	1.0	0.35 $^{+0.15}_{-0.20}$
C	5.0	5.8 ± 0.3	5.3	6.5 max	2.2	0.65 ± 0.1	1.5	0.35 $^{+0.15}_{-0.20}$
D	6.3	5.8 ± 0.3	6.6	7.8 max	2.6	0.65 ± 0.1	1.8	0.35 $^{+0.15}_{-0.20}$
D8	6.3	7.7 ± 0.3	6.6	7.8 max	2.6	0.65 ± 0.1	1.8	0.35 $^{+0.15}_{-0.20}$
F	8.0	10.2 ± 0.3	8.3	10.0 max	3.4	0.90 ± 0.2	3.1	0.70 ± 0.20
G	10.0	10.2 ± 0.3	10.3	12.0 max	3.5	0.90 ± 0.2	4.6	0.70 ± 0.20

Characteristics list

Endurance : 105 °C 2000 h

Rated voltage (V.DC)	Cap. (±20 %) (μF)	Case size (mm)		Size Code	Specification			Part No.	Reflow	Min. Packaging Qty
		φD	L		Ripple current (100 kHz) (+105 °C) (mA r.m.s.)	ESR (100 kHz) (+20 °C) (Ω)	tan δ (120 Hz) (+20 °C)			Taping (pcs)
6.3	68	4	5.8	B	90	1.35	0.26	EEEFK0J680SR	(5)	2000
	150	5	5.8	C	160	0.70	0.26	EEEFK0J151SR	(5)	1000
	270	6.3	5.8	D	240	0.36	0.26	EEEFK0J271SP	(5)	1000
	470	6.3	7.7	D8	280	0.34	0.26	EEEFKJ471XSP	(5)	900
	1800	10	10.2	G	850	0.08	0.26	EEEFK0J182SP	(6)	500
10	56	4	5.8	B	90	1.35	0.19	EEEFK1A560SR	(5)	2000
	120	5	5.8	C	160	0.70	0.19	EEEFK1A121SR	(5)	1000
	220	6.3	5.8	D	240	0.36	0.19	EEEFK1A221SP	(5)	1000
	330	6.3	7.7	D8	280	0.34	0.19	EEEFKA331XSP	(5)	900
	820	8	10.2	F	600	0.16	0.19	EEEFK1A821SP	(6)	500
	1200	10	10.2	G	850	0.08	0.19	EEEFK1A122SP	(6)	500
16	47	4	5.8	B	90	1.35	0.16	EEEFK1C470SR	(5)	2000
	100	5	5.8	C	160	0.70	0.16	EEEFK1C101SR	(5)	1000
	150	6.3	5.8	D	240	0.36	0.16	EEEFK1C151SP	(5)	1000
	270	6.3	7.7	D8	280	0.34	0.16	EEEFKC271XSP	(5)	900
	560	8	10.2	F	600	0.16	0.16	EEEFK1C561SP	(6)	500
	1000	10	10.2	G	850	0.08	0.16	EEEFK1C102SP	(6)	500
25	27	4	5.8	B	90	1.35	0.14	EEEFK1E270SR	(5)	2000
	56	5	5.8	C	160	0.70	0.14	EEEFK1E560SR	(5)	1000
	100	6.3	5.8	D	240	0.36	0.14	EEEFK1E101SP	(5)	1000
	150	6.3	7.7	D8	280	0.34	0.14	EEEFKE151XSP	(5)	900
	180	6.3	7.7	D8	280	0.34	0.14	EEEFKE181XSP	(5)	900
	390	8	10.2	F	600	0.16	0.14	EEEFK1E391SP	(6)	500
	680	10	10.2	G	850	0.08	0.14	EEEFK1E681SP	(6)	500
35	18	4	5.8	B	90	1.35	0.12	EEEFK1V180SR	(5)	2000
	39	5	5.8	C	160	0.70	0.12	EEEFK1V390SR	(5)	1000
	68	6.3	5.8	D	240	0.36	0.12	EEEFK1V680SP	(5)	1000
	82	6.3	5.8	D	240	0.36	0.12	EEEFK1V820SP	(5)	1000
	120	6.3	7.7	D8	280	0.34	0.12	EEEFKV121XSP	(5)	900
	270	8	10.2	F	600	0.16	0.12	EEEFK1V271SP	(6)	500
	470	10	10.2	G	850	0.08	0.12	EEEFK1V471SP	(6)	500
50	10	4	5.8	B	60	3.50	0.10	EEEFK1H100SR	(5)	2000
	22	5	5.8	C	85	1.52	0.10	EEEFK1H220SR	(5)	1000
	39	6.3	5.8	D	165	0.88	0.10	EEEFK1H390SP	(5)	1000
	82	6.3	7.7	D8	195	0.68	0.10	EEEFKH820XSP	(5)	900
	180	8	10.2	F	350	0.34	0.10	EEEFK1H181SP	(6)	500
	270	10	10.2	G	670	0.18	0.10	EEEFK1H271SP	(6)	500

If Part number exceeds 12 digits, voltage code is abbreviated as follows; 0J → J, 1A → A, 1C → C, 1E → E, 1V → V, 1H → H

· Please refer to the page of "Reflow Profile" and "The Taping Dimensions".

· When requesting vibration-proof product, please put the last "V" instead to "P"

Surface Mount Type

Series : Medium-size **FKS** Type : **V**
High temperature
Lead-Free reflow



Features

- Endurance : 105 °C 5000 h
- High capacitance : 20 to 80 % higher than FK series, large capacitance up to 13000 µF
- Vibration-proof product is available upon request.
- RoHS compliant

Specifications

Category temperature range	-55 °C to +105 °C						
Rated voltage range	6.3 V.DC to 35 V.DC						
Capacitance range	750 µF to 13000 µF						
Capacitance tolerance	±20 % (120 Hz/+20 °C)						
Leakage current	I ≤ 0.01 CV (µA) After 2 minutes						
Dissipation factor (tan δ)	Please see the attached characteristics list						
Characteristics at low temperature	V.DC	6.3	10	16	25	35	(Impedance ratio at 120 Hz)
	Z(-25 °C)/Z(+20 °C)	2	2	2	2	2	
	Z(-40 °C)/Z(+20 °C)	3	3	3	3	3	
Endurance	After applying rated working voltage for 5000 hours at +105 °C±2 °C and then being stabilized at +20 °C, Capacitors shall meet the following limits.						
	Capacitance change	Within ±30 % of the initial value					
	tan δ	≤ 300 % of the initial limit					
Shelf life	After storage for 1000 hours at +105 °C±2 °C with no voltage applied and then being stabilized at +20 °C, capacitors shall meet the limits specified in Endurance (With voltage treatment)						
	Capacitance change	Within ±30 % of the initial value					
	tan δ	≤ 200 % of the initial limit					
Resistance to soldering heat	After reflow soldering and then being stabilized at +20 °C, capacitors shall meet the following limits.						
	Capacitance change	Within ±10 % of the initial value					
	tan δ	Within the initial limit					
AEC-Q200	AEC-Q200 compliant						

Frequency correction factor for ripple current

Frequency (Hz)	120	1 k	10 k	100 k to
Correction factor	0.75	0.90	0.95	1.00

Marking

Example : 6.3 V.DC 3500 µF
 Marking color : BLACK

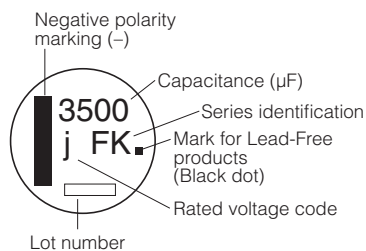

R. Voltage (V.DC)	6.3	10	16	25	35
Code	j	A	C	E	V

Dimensions

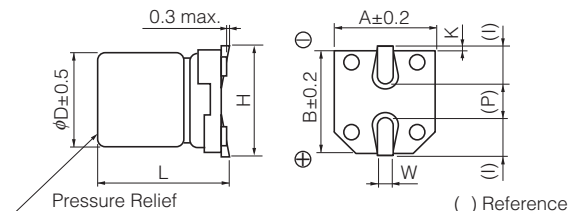

Size code	φD	L	A, B	H	I	W	P	K
H13	12.5	13.5±0.5	13.5	15.0 max.	4.7	0.90±0.3	4.4	0.70±0.30
J16	16.0	16.5±0.5	17.0	19.0 max.	5.5	1.20±0.3	6.7	0.70±0.30
K16	18.0	16.5±0.5	19.0	21.0 max.	6.7	1.20±0.3	6.7	0.70±0.30
K21	18.0	21.5±0.5	19.0	21.0 max.	6.7	1.20±0.3	6.7	0.70±0.30

Characteristics list

Endurance : 105 °C 5000 h

Rated voltage (V.DC)	Cap. (±20 %) (μF)	Case size (mm)		Size code	Specification			Part No.		Reflow	Min. Packaging Qty
		φD	L		Ripple current (100 kHz) (+105 °C) (mA r.m.s.)	Impedance (100 kHz) (+20 °C) (Ω)	tan δ (120 Hz) (+20 °C)	Standard Product	Vibration-proof Product		Taping (pcs)
6.3	3500	12.5	13.5	H13	1100	0.06	0.30	EEEFK0J352SQ	EEEFK0J352SV	(9)	200
	7500	16	16.5	J16	1800	0.035	0.38	EEEFK0J752SM	EEEFK0J752SV	(9)	125
	10000	18	16.5	K16	2060	0.033	0.42	EEEFK0J103SM	EEEFK0J103SV	(9)	125
	13000	18	21.5	K21	2640	0.025	0.50	EEEFK0J133SM	EEEFK0J133SV	(9)	75
10	2400	12.5	13.5	H13	1100	0.06	0.21	EEEFK1A242SQ	EEEFK1A242SV	(9)	200
	5600	16	16.5	J16	1800	0.035	0.27	EEEFK1A562SM	EEEFK1A562SV	(9)	125
	7500	18	16.5	K16	2060	0.033	0.31	EEEFK1A752SM	EEEFK1A752SV	(9)	125
	9100	18	21.5	K21	2640	0.025	0.35	EEEFK1A912SM	EEEFK1A912SV	(9)	75
16	1800	12.5	13.5	H13	1100	0.06	0.16	EEEFK1C182SQ	EEEFK1C182SV	(9)	200
	4300	16	16.5	J16	1800	0.035	0.22	EEEFK1C432SM	EEEFK1C432SV	(9)	125
	5600	18	16.5	K16	2060	0.033	0.24	EEEFK1C562SM	EEEFK1C562SV	(9)	125
	7500	18	21.5	K21	2640	0.025	0.28	EEEFK1C752SM	EEEFK1C752SV	(9)	75
25	1200	12.5	13.5	H13	1100	0.06	0.14	EEEFK1E122SQ	EEEFK1E122SV	(9)	200
	2700	16	16.5	J16	1800	0.035	0.16	EEEFK1E272SM	EEEFK1E272SV	(9)	125
	3600	18	16.5	K16	2060	0.033	0.18	EEEFK1E362SM	EEEFK1E362SV	(9)	125
	4700	18	21.5	K21	2640	0.025	0.20	EEEFK1E472SM	EEEFK1E472SV	(9)	75
35	750	12.5	13.5	H13	1100	0.06	0.12	EEEFK1V751SQ	EEEFK1V751SV	(9)	200
	1600	16	16.5	J16	1800	0.035	0.14	EEEFK1V162SM	EEEFK1V162SV	(9)	125
	2200	18	16.5	K16	2060	0.033	0.14	EEEFK1V222SM	EEEFK1V222SV	(9)	125
	3000	18	21.5	K21	2640	0.025	0.16	EEEFK1V302SM	EEEFK1V302SV	(9)	75

· Please refer to the page of "Reflow Profile" and "The Taping Dimensions".

Surface Mount Type

Series : **FT** Type : **V**

High temperature Lead-Free reflow



Features

- Endurance : 105 °C 2000 h to 5000 h
- Miniaturized, Low ESR (1 size smaller than series FK)
- Vibration-proof product is available upon request. ($\phi 8$ mm and larger)
- RoHS compliant

Specifications

Category temperature range	-55 °C to +105 °C	
Rated voltage range	6.3 V.DC to 50 V.DC	
Capacitance range	10 μ F to 2200 μ F	
Capacitance tolerance	± 20 % (120 Hz/+20 °C)	
Leakage current	$I \leq 0.01$ CV (μ A) After 2 minutes	
Dissipation factor (tan δ)	Please see the attached characteristics list	
Endurance	After applying rated working voltage for 2000 hours at +105 °C ± 2 °C and then being stabilized at +20 °C, Capacitors shall meet the following limits. (Suffix "G" in 6.3 V.DC : 3000 hours, 10 V.DC to 50 V.DC : 5000 hours)	
	Capacitance change	Within ± 30 % of the initial value (Suffix "G" is ± 35 %)
	tan δ	≤ 200 % of the initial limit (Suffix "G" is ≤ 300 %)
Shelf life	After storage for 1000 hours at +105 °C ± 2 °C with no voltage applied and then being stabilized at +20 °C, capacitors shall meet the limits specified in Endurance. (With voltage treatment)	
	After reflow soldering and then being stabilized at +20 °C, capacitor shall meet the following limits.	
Resistance to soldering heat	Capacitance change	Within ± 10 % of the initial value
	tan δ	Within the initial limit
	DC leakage current	Within the initial limit
AEC-Q200	AEC-Q200 compliant	

Frequency correction factor for ripple current

Capacitance (μ F)	Frequency (Hz)			
	120	1 k	10 k	100 k to
10 to 470	0.65	0.85	0.95	1.00
560 to 2200	0.70	0.90	0.95	1.00

Marking

Example : 25 V.DC 22 μ F
Marking color : BLACK

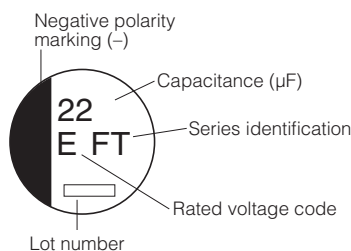

R. Voltage (V.DC)	6.3	10	16	25	35	50
Code	j	A	C	E	V	H

Dimensions

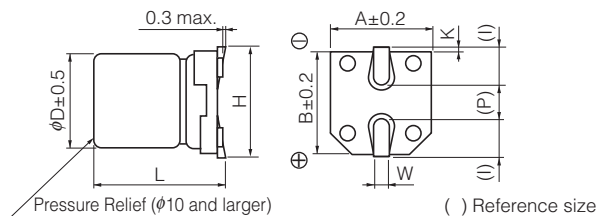

Size code	ϕD	L	A, B	H	I	W	P	K
B	4.0	5.8 ± 0.3	4.3	5.5 max.	1.8	0.65 ± 0.1	1.0	0.35 $^{+0.15}_{-0.20}$
C	5.0	5.8 ± 0.3	5.3	6.5 max.	2.2	0.65 ± 0.1	1.5	0.35 $^{+0.15}_{-0.20}$
D	6.3	5.8 ± 0.3	6.6	7.8 max.	2.6	0.65 ± 0.1	1.8	0.35 $^{+0.15}_{-0.20}$
D8	6.3	7.7 ± 0.3	6.6	7.8 max.	2.6	0.65 ± 0.1	1.8	0.35 $^{+0.15}_{-0.20}$
F	8.0	10.2 ± 0.3	8.3	10.0 max.	3.4	0.90 ± 0.2	3.1	0.70 ± 0.20
G	10.0	10.2 ± 0.3	10.3	12.0 max.	3.5	0.90 ± 0.2	4.6	0.70 ± 0.20

Characteristics list

Endurance : 105 °C 2000 h

Rated voltage (V.DC)	Cap. (±20 %) (μF)	Case size (mm)		Size* code	Specification			Part No.	Reflow	Min. Packaging Q'ty
		φD	L		Ripple current (100 kHz) (+105 °C) (mA r.m.s.)	ESR (100 kHz) (+20 °C) (Ω)	tan δ (120 Hz) (+20 °C)			Taping (pcs)
6.3	100	4	5.8	B	160	0.85	0.26	EEEFT0J101AR	(5)	2000
	220	5	5.8	C	240	0.36	0.26	EEEFT0J221AR	(5)	1000
	330	6.3	5.8	D	300	0.26	0.26	EEEFT0J331AP	(5)	1000
	470	6.3	7.7	D8	600	0.16	0.26	EEEFTJ471XAP	(5)	900
	680	6.3	7.7	D8	600	0.16	0.26	EEEFTJ681XAP	(5)	900
	1500	8	10.2	F	850	0.08	0.26	EEEFT0J152AP	(6)	500
10	2200	10	10.2	G	1190	0.06	0.28	EEEFT0J222AP	(6)	500
	68	4	5.8	B	160	0.85	0.19	EEEFT1A680AR	(5)	2000
	150	5	5.8	C	240	0.36	0.19	EEEFT1A151AR	(5)	1000
	220	6.3	5.8	D	300	0.26	0.19	EEEFT1A221AP	(5)	1000
	330	6.3	7.7	D8	600	0.16	0.19	EEEFTA331XAP	(5)	900
	470	6.3	7.7	D8	600	0.16	0.19	EEEFTA471XAP	(5)	900
16	1000	8	10.2	F	850	0.08	0.19	EEEFT1A102AP	(6)	500
	1500	10	10.2	G	1190	0.06	0.19	EEEFT1A152AP	(6)	500
	47	4	5.8	B	160	0.85	0.16	EEEFT1C470AR	(5)	2000
	68	5	5.8	C	240	0.36	0.16	EEEFT1C680AR	(5)	1000
	100	5	5.8	C	240	0.36	0.16	EEEFT1C101AR	(5)	1000
	150	6.3	5.8	D	300	0.26	0.16	EEEFT1C151AP	(5)	1000
25	220	6.3	5.8	D	300	0.26	0.16	EEEFT1C221AP	(5)	1000
	330	6.3	7.7	D8	600	0.16	0.16	EEEFTC331XAP	(5)	900
	680	8	10.2	F	850	0.08	0.16	EEEFT1C681AP	(6)	500
	820	8	10.2	F	850	0.08	0.16	EEEFT1C821UP	(6)	500
	1000	10	10.2	G	1190	0.06	0.16	EEEFT1C102AP	(6)	500
	1200	10	10.2	G	1190	0.06	0.16	EEEFT1C122UP	(6)	500
35	22	4	5.8	B	160	0.85	0.14	EEEFT1E220AR	(5)	2000
	33	4	5.8	B	160	0.85	0.14	EEEFT1E330AR	(5)	2000
	47	5	5.8	C	240	0.36	0.14	EEEFT1E470AR	(5)	1000
	68	5	5.8	C	240	0.36	0.14	EEEFT1E680AR	(5)	1000
	100	6.3	5.8	D	300	0.26	0.14	EEEFT1E101AP	(5)	1000
	150	6.3	7.7	D8	600	0.16	0.14	EEEFT1E151XAP	(5)	900
	220	6.3	7.7	D8	600	0.16	0.14	EEEFT1E221XAP	(5)	900
	470	8	10.2	F	850	0.08	0.14	EEEFT1E471AP	(6)	500
	560	8	10.2	F	850	0.08	0.14	EEEFT1E561UP	(6)	500
	820	10	10.2	G	1190	0.06	0.14	EEEFT1E821AP	(6)	500
50	1000	10	10.2	G	1190	0.06	0.14	EEEFT1E102UP	(6)	500
	22	4	5.8	B	160	0.85	0.12	EEEFT1V220AR	(5)	2000
	33	5	5.8	C	240	0.36	0.12	EEEFT1V330AR	(5)	1000
	47	5	5.8	C	240	0.36	0.12	EEEFT1V470AR	(5)	1000
	68	6.3	5.8	D	300	0.26	0.12	EEEFT1V680AP	(5)	1000
	100	6.3	5.8	D	300	0.26	0.12	EEEFT1V101AP	(5)	1000
	150	6.3	7.7	D8	600	0.16	0.12	EEEFTV151XAP	(5)	900
	330	8	10.2	F	850	0.08	0.12	EEEFT1V331AP	(6)	500
	390	8	10.2	F	850	0.08	0.12	EEEFT1V391UP	(6)	500
	560	10	10.2	G	1190	0.06	0.12	EEEFT1V561AP	(6)	500
50	680	10	10.2	G	1190	0.06	0.12	EEEFT1V681UP	(6)	500
	10	4	5.8	(B)	85	2.30	0.10	EEEFTH100UAR	(5)	2000
		5	5.8	C	165	0.88	0.10	EEEFT1H100AR	(5)	1000
	22	5	5.8	C	165	0.88	0.10	EEEFT1H220AR	(5)	1000
	47	6.3	5.8	D	195	0.68	0.10	EEEFT1H470AP	(5)	1000
	100	6.3	7.7	D8	350	0.34	0.10	EEEFTH101XAP	(5)	900
50	220	8	10.2	F	670	0.18	0.10	EEEFT1H221AP	(6)	500
	330	10	10.2	G	900	0.12	0.10	EEEFT1H331AP	(6)	500

* Size code() : Miniaturization product

If Part number exceeds 12 digits, voltage code is abbreviated as follows; 0J → J, 1A → A, 1C → C, 1E → E, 1V → V, 1H → H

· Please refer to the page of "Reflow Profile" and "The Taping Dimensions".

· When requesting vibration-proof product, please put the last "V" instead to "P"

Design and specifications are each subject to change without notice. Ask factory for the current technical specifications before purchase and/or use.

Should a safety concern arise regarding this product, please be sure to contact us immediately.

Characteristics list (Endurance 5000 h)

Endurance : 105 °C 5000 h (6.3 V.DC : 105 °C 3000 h)

Rated voltage (V.DC)	Cap. (±20 %) (μF)	Case size (mm)		Size code	Specification			Part No.	Reflow	Min. Packaging Q'ty
		φD	L		Ripple current (100 kHz) (+105 °C) (mA r.m.s.)	ESR (100 kHz) (+20 °C) (Ω)	tan δ (120 Hz) (+20 °C)			Taping (pcs)
6.3	1500	8	10.2	F	850	0.08	0.26	EEEFT0J152GP	(6)	500
	2200	10	10.2	G	1190	0.06	0.28	EEEFT0J222GP	(6)	500
10	1000	8	10.2	F	850	0.08	0.19	EEEFT1A102GP	(6)	500
	1500	10	10.2	G	1190	0.06	0.19	EEEFT1A152GP	(6)	500
16	680	8	10.2	F	850	0.08	0.16	EEEFT1C681GP	(6)	500
	1000	10	10.2	G	1190	0.06	0.16	EEEFT1C102GP	(6)	500
25	470	8	10.2	F	850	0.08	0.14	EEEFT1E471GP	(6)	500
	820	10	10.2	G	1190	0.06	0.14	EEEFT1E821GP	(6)	500
35	330	8	10.2	F	850	0.08	0.12	EEEFT1V331GP	(6)	500
	560	10	10.2	G	1190	0.06	0.12	EEEFT1V561GP	(6)	500
50	220	8	10.2	F	670	0.18	0.10	EEEFT1H221GP	(6)	500
	330	10	10.2	G	900	0.12	0.10	EEEFT1H331GP	(6)	500

- Please refer to the page of "Reflow Profile" and "The Taping Dimensions".
- When requesting vibration-proof product, please put the last "V" instead to "P"

Surface Mount Type

Series : **FP** Type : **V**

High temperature

Lead-Free reflow (suffix : A*)



Features

- Low ESR (30 % to 50 % less than FK series)
- Endurance : 105 °C 2000 h
- Vibration-proof product is available upon request. (08 mm and larger)
- RoHS compliant

Specifications

Category temperature range	-55 °C to +105 °C							
Rated voltage range	6.3 V.DC to 50 V.DC							
Capacitance range	10 µF to 1800 µF							
Capacitance tolerance	±20 % (120 Hz/+20 °C)							
Leakage current	I ≤ 0.01 CV or 3 (µA) After 2 minutes (whichever is greater)							
Dissipation factor (tan δ)	Please see the attached characteristics list							
Characteristics at low temperature	V.DC	6.3	10	16	25	35	50	(Impedance ratio at 120 Hz)
	Z(-25 °C)/Z(+20 °C)	2	2	2	2	2	2	
	Z(-40°C)/Z(+20 °C)	3	3	3	3	3	3	
	Z(-55°C)/Z(+20 °C)	4	4	4	3	3	3	
Endurance	After applying rated working voltage at +105 °C ±2 °C for 2000 hours the capacitors shall meet the limits specified below. Post-test requirement at +20 °C							
	Capacitance change	Within ±30 % of the initial value						
	tan δ	≤200 % of the initial limit						
Shelf life	After storage for 1000 hours at +105 °C±2 °C with no voltage applied and then being stabilized at +20 °C, capacitors shall meet the limits specified in Endurance. (With voltage treatment)							
	After reflow soldering and then being stabilized at +20 °C, capacitors shall meet the following limits.							
Resistance to soldering heat	Capacitance change	Within ±10 % of the initial value						
	tan δ	Within the initial limit						
	DC leakage current	Within the initial limit						
AEC-Q200	AEC-Q200 compliant							

Frequency correction factor for ripple current

Capacitance (µF)	Frequency (Hz)			
	120	1 k	10 k	100 k to
10 to 470	0.65	0.85	0.95	1.00
560 to 1800	0.75	0.90	0.95	1.00

Marking

Example : 6.3 V.DC 22 µF
Marking color : BLACK

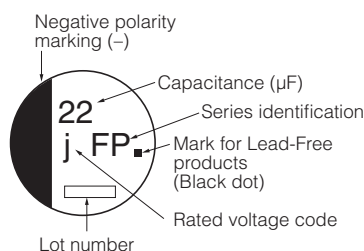

R. Voltage (V.DC)	6.3	10	16	25	35	50
Code	j	A	C	E	V	H

Dimensions

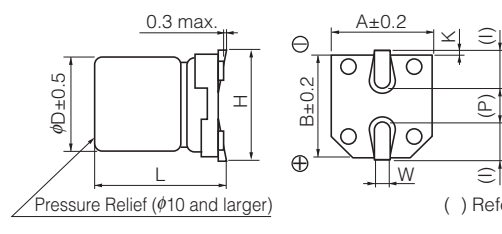

Size code	φD	L	A, B	H	I	W	P	K
B	4.0	5.8±0.30	4.3	5.5 max.	1.8	0.65±0.1	1.0	0.35 ^{+0.15} _{-0.20}
C	5.0	5.8±0.30	5.3	6.5 max.	2.2	0.65±0.1	1.5	0.35 ^{+0.15} _{-0.20}
D	6.3	5.8±0.30	6.6	7.8 max.	2.6	0.65±0.1	1.8	0.35 ^{+0.15} _{-0.20}
D8	6.3	7.7±0.30	6.6	7.8 max.	2.6	0.65±0.1	1.8	0.35 ^{+0.15} _{-0.20}
E	8.0	6.2±0.30	8.3	9.5 max.	3.4	0.65±0.1	2.2	0.35 ^{+0.15} _{-0.20}
F	8.0	10.2±0.30	8.3	10.0 max.	3.4	0.90±0.2	3.1	0.70±0.20
G	10.0	10.2±0.30	10.3	12.0 max.	3.5	0.90±0.2	4.6	0.70±0.20

Characteristics list

Endurance : 105 °C 2000 h

Rated voltage (V.DC)	Cap. (±20 %) (μF)	Case size (mm)		Size* code	Specification			Part No.	Reflow	Min. Packaging Qty
		φD	L		Ripple current (100 kHz) (+105 °C) (mA r.m.s.)	ESR (100 kHz) (+20 °C) (Ω)	tan δ (120 Hz) (+20 °C)			Taping (pcs)
6.3	22	4	5.8	B	160	0.85	0.26	EEEEFP0J220AR	(5)	2000
	47	4	5.8	(B)	160	0.85	0.26	EEEEFPJ470UAR	(5)	2000
		5	5.8	C	240	0.36	0.26	EEEEFP0J470AR	(5)	1000
	100	5	5.8	(C)	240	0.36	0.26	EEEEFPJ101UAR	(5)	1000
		6.3	5.8	D	300	0.26	0.26	EEEEFP0J101AP	(5)	1000
	220	6.3	5.8	D	300	0.26	0.26	EEEEFP0J221AP	(5)	1000
	330	6.3	7.7	D8	600	0.16	0.26	EEEEFPJ331XAP	(5)	900
		8	6.2	E	500	0.18	0.26	EEEEFP0J331AP	(6)	1000
	470	8	10.2	F	850	0.08	0.26	EEEEFP0J471AP	(6)	500
	1000	8	10.2	F	850	0.08	0.26	EEEEFP0J102AP	(6)	500
1500	10	10.2	G	1190	0.06	0.26	EEEEFP0J152AP	(6)	500	
1800	10	10.2	(G)	850	0.08	0.26	EEEEFPJ182UAP	(6)	500	
10	22	4	5.8	B	160	0.85	0.19	EEEEFP1A220AR	(5)	2000
	33	4	5.8	(B)	160	0.85	0.19	EEEEFPA330UAR	(5)	2000
		5	5.8	C	240	0.36	0.19	EEEEFP1A330AR	(5)	1000
	150	6.3	5.8	D	300	0.26	0.19	EEEEFP1A151AP	(5)	1000
	220	6.3	7.7	D8	600	0.16	0.19	EEEEFPA221XAP	(5)	900
		8	6.2	E	500	0.18	0.19	EEEEFP1A221AP	(6)	1000
	330	8	10.2	F	850	0.08	0.19	EEEEFP1A331AP	(6)	500
	470	8	10.2	F	850	0.08	0.19	EEEEFP1A471AP	(6)	500
	680	8	10.2	F	850	0.08	0.19	EEEEFP1A681AP	(6)	500
	1000	10	10.2	G	1190	0.06	0.19	EEEEFP1A102AP	(6)	500
1200	10	10.2	(G)	850	0.08	0.19	EEEEFPA122UAP	(6)	500	
16	10	4	5.8	B	160	0.85	0.16	EEEEFP1C100AR	(5)	2000
	22	4	5.8	(B)	160	0.85	0.16	EEEEFPC220UAR	(5)	2000
		5	5.8	C	240	0.36	0.16	EEEEFP1C220AR	(5)	1000
	47	5	5.8	(C)	240	0.36	0.16	EEEEFPC470UAR	(5)	1000
		6.3	5.8	D	300	0.26	0.16	EEEEFP1C470AP	(5)	1000
	68	6.3	5.8	D	300	0.26	0.16	EEEEFP1C680AP	(5)	1000
	100	6.3	5.8	D	300	0.26	0.16	EEEEFP1C101AP	(5)	1000
		6.3	7.7	D8	600	0.16	0.16	EEEEFPC101XAP	(5)	900
	150	6.3	7.7	D8	600	0.16	0.16	EEEEFPC151XAP	(5)	900
	220	6.3	7.7	D8	600	0.16	0.16	EEEEFPC221XAP	(5)	900
		8	6.2	E	500	0.18	0.16	EEEEFP1C221AP	(6)	1000
	330	8	10.2	F	850	0.08	0.16	EEEEFP1C331AP	(6)	500
	470	8	10.2	F	850	0.08	0.16	EEEEFP1C471AP	(6)	500
680	10	10.2	G	1190	0.06	0.16	EEEEFP1C681AP	(6)	500	
820	10	10.2	(G)	850	0.08	0.16	EEEEFPC821UAP	(6)	500	
25	10	4	5.8	B	160	0.85	0.14	EEEEFP1E100AR	(5)	2000
	22	5	5.8	C	240	0.36	0.14	EEEEFP1E220AR	(5)	1000
		5	5.8	(C)	240	0.36	0.14	EEEEFPE330UAR	(5)	1000
	33	6.3	5.8	D	300	0.26	0.14	EEEEFP1E330AP	(5)	1000
		47	6.3	5.8	D	300	0.26	0.14	EEEEFP1E470AP	(5)
	68	6.3	5.8	D	300	0.26	0.14	EEEEFP1E680AP	(5)	1000
	100	6.3	7.7	D8	600	0.16	0.14	EEEEFPE101XAP	(5)	900
		8	6.2	E	500	0.18	0.14	EEEEFP1E101AP	(6)	1000
	150	8	10.2	F	850	0.08	0.14	EEEEFP1E151AP	(6)	500
	220	8	10.2	F	850	0.08	0.14	EEEEFP1E221AP	(6)	500
	330	8	10.2	F	850	0.08	0.14	EEEEFP1E331AP	(6)	500
	470	10	10.2	G	1190	0.06	0.14	EEEEFP1E471AP	(6)	500
	560	10	10.2	(G)	850	0.08	0.14	EEEEFPE561UAP	(6)	500

* Size code() : Miniaturization product

If Part number exceeds 12 digits, voltage code is abbreviated as follows; 0J → J, 1A → A, 1C → C, 1E → E, 1V → V

· Please refer to the page of "Reflow Profile" and "The Taping Dimensions".

· When requesting vibration-proof product, please put the last "V" instead to "P"

Characteristics list

Endurance : 105 °C 2000 h

Rated voltage (V.DC)	Cap. (±20 %) (μF)	Case size (mm)		Size* code	Specification			Part No.	Reflow	Min. Packaging Qty	
		φD	L		Ripple current (100 kHz) (+105 °C) (mA r.m.s.)	ESR (100 kHz) (+20 °C) (Ω)	tan δ (120 Hz) (+20 °C)			Taping (pcs)	
35	10	4	5.8	(B)	160	0.85	0.12	EEEEPV100UAR	(5)	2000	
	22	5	5.8	C	240	0.36	0.12	EEEEP1V220AR	(5)	1000	
	33	6.3	5.8	D	300	0.26	0.12	EEEEP1V330AP	(5)	1000	
	47	6.3	5.8	D	300	0.26	0.12	EEEEP1V470AP	(5)	1000	
	68	6.3	7.7	D8	600	0.16	0.12	EEEEPV680XAP	(5)	900	
	100	6.3	7.7	D8	600	0.16	0.12	EEEEPV101XAP	(5)	900	
		8	10.2	F	850	0.08	0.12	EEEEP1V101AP	(6)	500	
	150	8	10.2	F	850	0.08	0.12	EEEEP1V151AP	(6)	500	
	220	8	10.2	F	850	0.08	0.12	EEEEP1V221AP	(6)	500	
	330	10	10.2	G	1190	0.06	0.12	EEEEP1V331AP	(6)	500	
390	10	10.2	(G)	850	0.08	0.12	EEEEPV391UAP	(6)	500		
50	100	8	10.2	F	670	0.18	0.10	EEEEP1H101AP	(6)	500	
	220	10	10.2	G	900	0.12	0.10	EEEEP1H221AP	(6)	500	

* Size code() : Miniaturization product

If Part number exceeds 12 digits, voltage code is abbreviated as follows; 0J → J, 1A → A, 1C → C, 1E → E, 1V → V

· Please refer to the page of "Reflow Profile" and "The Taping Dimensions".

· When requesting vibration-proof product, please put the last "V" instead to "P"

Surface Mount Type

Series : **TG** Type : **V**



Features

- Endurance : 125 °C 1000 h to 2000 h
- Miniaturization (40 % less than TA Series)
- Low ESR (Low temp)
- Vibration-proof product is available upon request. ($\phi 8$ mm and larger)
- RoHS compliant (Parts No $\phi 8$ to $\phi 10$: **EEE***, $\phi 12.5$ to $\phi 18$: **EEV***)

Specifications

Category temperature range	-40 °C to +125 °C									
Rated voltage range	10 V.DC to 100 V.DC									
Capacitance range	10 μ F to 4700 μ F									
Capacitance tolerance	± 20 % (120 Hz/+20 °C)									
Leakage current	$I \leq 0.01$ CV After 2 minutes									
Dissipation factor (tan δ)	Please see the attached characteristics list									
Characteristics at low temperature	V.DC	10	16	25	35	50	63	80	100	(Impedance ratio at 120 Hz)
	Z(-25 °C)/Z(+20 °C)	3	2	2	2	2	2	2	2	
	Z(-40 °C)/Z(+20 °C)	6	4	4	3	3	3	3	3	
Endurance	After applying rated working voltage for 1000 hours ($\phi 8 \times 6.2$), 2000 hours ($\phi 8 \times 10.2 \leq$) at +125 °C ± 2 °C and then being stabilized at +20 °C, capacitors shall meet the following limits.									
	Capacitance change	Within ± 30 % of the initial value (code U : ± 35 %)								
	tan δ	≤ 300 % of the initial limit (code U : ± 350 %)								
Shelf life	After storage for 1000 hours at +125 °C ± 2 °C with no voltage applied and then being stabilized at +20 °C, capacitors shall meet the limits specified in Endurance (With voltage treatment)									
	After reflow soldering and then being stabilized at +20 °C, capacitors shall meet the following limits.									
Resistance to soldering heat	Capacitance change	Within ± 10 % of the initial value								
	tan δ	Within the initial limit								
	DC leakage current	Within the initial limit								
AEC-Q200	AEC-Q200 compliant									

Frequency correction factor for ripple current

Frequency (Hz)	120	1 k	10 k	100 k to
Correction factor	0.65	0.85	0.95	1.00

Marking

Example : 10 V.DC 100 μ F, 10 V.DC 1000 μ F
 Marking color : BLACK
 Lead-Free products ($\leq \phi 10$)

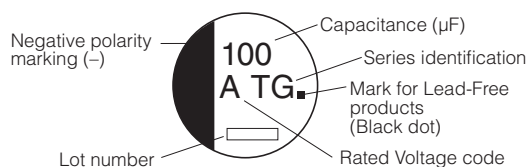

Lead-Free products ($\geq \phi 12.5$)

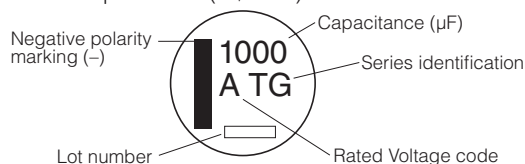

R. Voltage (V.DC)	10	16	25	35	50	63	80	100
Code	A	C	E	V	H	J	K	2A

Dimensions

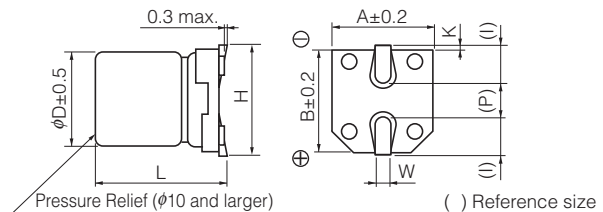

(Unit : mm)

Size code	ϕD	L	A, B	H	I	W	P	K
E	8.0	6.2 ± 0.3	8.3	9.5 max.	3.4	0.65 ± 0.1	2.2	0.35 $^{+0.15}_{-0.20}$
F	8.0	10.2 ± 0.3	8.3	10.0 max.	3.4	0.90 ± 0.2	3.1	0.70 ± 0.20
G	10.0	10.2 ± 0.3	10.3	12.0 max.	3.5	0.90 ± 0.2	4.6	0.70 ± 0.20
H13	12.5	13.5 ± 0.5	13.5	15.0 max.	4.7	0.90 ± 0.3	4.4	0.70 ± 0.30
J16	16.0	16.5 ± 0.5	17.0	19.0 max.	5.5	1.20 ± 0.3	6.7	0.70 ± 0.30
K16	18.0	16.5 ± 0.5	19.0	21.0 max.	6.7	1.20 ± 0.3	6.7	0.70 ± 0.30

Characteristics list

Endurance : 125 °C 1000 h ($\phi 8 \times 10.2 \leq$: 2000 h)

Rated voltage (V.DC)	Cap. ($\pm 20\%$) (μF)	Case size (mm)		Size* code	Specification			Part No.	Reflow	Min. Packaging Qty	
		ϕD	L		Ripple current (100 kHz) (+125 °C) (mA r.m.s.)	ESR (100 kHz) (+20 °C) (Ω)	$\tan \delta$ (120 Hz) (+20 °C)			Taping (pcs)	
10	100	8	6.2	E	100	1.00	0.30	EEETG1A101P	(2)	1000	
	220	8	6.2	(E)	100	1.00	0.30	EEETG1A221UP	(2)	1000	
		8	10.2	F	197	0.50	0.30	EEETG1A221P	(2)	500	
	330	8	10.2	(F)	197	0.50	0.30	EEETG1A331UP	(2)	500	
		10	10.2	G	270	0.30	0.30	EEETG1A331P	(2)	500	
	470	10	10.2	(G)	270	0.30	0.30	EEETG1A471UP	(2)	500	
	1000	12.5	13.5	H13	800	0.12	0.30	EEVTG1A102Q	(3)	200	
	1500	12.5	13.5	(H13)	800	0.12	0.30	EEVTG1A152UQ	(3)	200	
	2200	16	16.5	J16	1100	0.08	0.32	EEVTG1A222M	(3)	125	
	3300	16	16.5	(J16)	1100	0.08	0.34	EEVTG1A332UM	(3)	125	
18		16.5	K16	1300	0.075	0.34	EEVTG1A332M	(3)	125		
4700	18	16.5	K16	1300	0.075	0.36	EEVTG1A472M	(3)	125		
16	100	8	10.2	F	197	0.50	0.23	EEETG1C101P	(2)	500	
	220	8	10.2	(F)	197	0.50	0.23	EEETG1C221UP	(2)	500	
		10	10.2	G	270	0.30	0.23	EEETG1C221P	(2)	500	
	330	10	10.2	(G)	270	0.30	0.23	EEETG1C331UP	(2)	500	
		12.5	13.5	H13	800	0.12	0.23	EEVTG1C331Q	(3)	200	
	470	12.5	13.5	H13	800	0.12	0.23	EEVTG1C471Q	(3)	200	
	680	12.5	13.5	H13	800	0.12	0.23	EEVTG1C681Q	(3)	200	
	1000	12.5	13.5	(H13)	800	0.12	0.23	EEVTG1C102UQ	(3)	200	
		16	16.5	J16	1100	0.08	0.23	EEVTG1C102M	(3)	125	
	2200	16	16.5	(J16)	1100	0.08	0.25	EEVTG1C222UM	(3)	125	
18		16.5	K16	1300	0.075	0.25	EEVTG1C222M	(3)	125		
3300	18	16.5	K16	1300	0.075	0.27	EEVTG1C332M	(3)	125		
25	47	8	6.2	E	100	1.00	0.18	EEETG1E470P	(2)	1000	
	100	8	6.2	(E)	100	1.00	0.18	EEETG1E101UP	(2)	1000	
		8	10.2	F	197	0.50	0.18	EEETG1E101P	(2)	500	
	220	8	10.2	(F)	197	0.50	0.18	EEETG1E221UP	(2)	500	
		10	10.2	G	270	0.30	0.18	EEETG1E221P	(2)	500	
	330	10	10.2	(G)	270	0.30	0.18	EEETG1E331UP	(2)	500	
		12.5	13.5	H13	800	0.12	0.18	EEVTG1E331Q	(3)	200	
	470	12.5	13.5	H13	800	0.12	0.18	EEVTG1E471Q	(3)	200	
	680	12.5	13.5	(H13)	800	0.12	0.18	EEVTG1E681UQ	(3)	200	
		16	16.5	J16	1100	0.08	0.18	EEVTG1E681M	(3)	125	
1000	16	16.5	(J16)	1100	0.08	0.18	EEVTG1E102UM	(3)	125		
	18	16.5	K16	1300	0.075	0.18	EEVTG1E102M	(3)	125		
2200	18	16.5	K16	1300	0.075	0.20	EEVTG1E222M	(3)	125		
35	33	8	6.2	E	100	1.00	0.16	EEETG1V330P	(2)	1000	
	47	8	6.2	(E)	100	1.00	0.16	EEETG1V470UP	(2)	1000	
		8	10.2	F	197	0.50	0.16	EEETG1V470P	(2)	500	
	100	8	10.2	(F)	197	0.50	0.16	EEETG1V101UP	(2)	500	
		10	10.2	G	270	0.30	0.16	EEETG1V101P	(2)	500	
	220	10	10.2	(G)	270	0.30	0.16	EEETG1V221UP	(2)	500	
	330	12.5	13.5	H13	800	0.12	0.16	EEVTG1V331Q	(3)	200	
		12.5	13.5	(H13)	800	0.12	0.16	EEVTG1V471UQ	(3)	200	
	470	16	16.5	J16	1100	0.08	0.16	EEVTG1V471M	(3)	125	
		16	16.5	(J16)	1100	0.08	0.16	EEVTG1V681UM	(3)	125	
680	18	16.5	K16	1300	0.075	0.16	EEVTG1V681M	(3)	125		
	1000	18	16.5	K16	1300	0.075	0.16	EEVTG1V102M	(3)	125	

* Size code() : Miniaturization product

· Please refer to the page of "Reflow Profile" and "The Taping Dimensions".

· When requesting vibration-proof product, please put the last "V" instead to "P", "Q", or "M"

Design and specifications are each subject to change without notice. Ask factory for the current technical specifications before purchase and/or use.

Should a safety concern arise regarding this product, please be sure to contact us immediately.

Characteristics list

Endurance : 125 °C 1000 h ($\phi 8 \times 10.2 \leq$: 2000 h)

Rated voltage (V.DC)	Cap. ($\pm 20\%$) (μF)	Case size (mm)		Size* code	Specification			Part No.	Reflow	Min. Packaging Qty	
		ϕD	L		Ripple current (100 kHz) (+125 °C) (mA r.m.s.)	ESR (100 kHz) (+20 °C) (Ω)	$\tan \delta$ (120 Hz) (+20 °C)			Taping (pcs)	
50	10	8	6.2	E	80	1.60	0.14	EEETG1H100P	(2)	1000	
	22	8	6.2	E	80	1.60	0.14	EEETG1H220P	(2)	1000	
	33	8	6.2	(E)	80	1.60	0.14	EEETG1H330UP	(2)	1000	
		8	10.2	F	133	0.75	0.14	EEETG1H330P	(2)	500	
	47	8	10.2	(F)	133	0.75	0.14	EEETG1H470UP	(2)	500	
		10	10.2	G	221	0.50	0.14	EEETG1H470P	(2)	500	
	100	10	10.2	(G)	221	0.50	0.14	EEETG1H101UP	(2)	500	
	220	12.5	13.5	H13	600	0.23	0.14	EEVTG1H221Q	(3)	200	
	330	12.5	13.5	H13	600	0.23	0.14	EEVTG1H331Q	(3)	200	
	470	16	16.5	J16	900	0.15	0.14	EEVTG1H471M	(3)	125	
	680	16	16.5	(J16)	900	0.15	0.14	EEVTG1H681UM	(3)	125	
18		16.5	K16	950	0.14	0.14	EEVTG1H681M	(3)	125		
1000	18	16.5	K16	950	0.14	0.14	EEVTG1H102M	(3)	125		
63	10	8	6.2	E	55	2.20	0.12	EEETG1J100P	(2)	1000	
	22	8	10.2	F	100	1.00	0.12	EEETG1J220P	(2)	500	
	33	8	10.2	(F)	100	1.00	0.12	EEETG1J330UP	(2)	500	
		10	10.2	G	150	0.80	0.12	EEETG1J330P	(2)	500	
	47	8	10.2	(F)	100	1.00	0.12	EEETG1J470UP	(2)	500	
		10	10.2	G	150	0.80	0.12	EEETG1J470P	(2)	500	
	100	10	10.2	(G)	150	0.80	0.12	EEETG1J101UP	(2)	500	
		12.5	13.5	H13	350	0.26	0.12	EEVTG1J101Q	(3)	200	
	220	12.5	13.5	H13	350	0.26	0.12	EEVTG1J221Q	(3)	200	
	330	16	16.5	J16	500	0.18	0.12	EEVTG1J331M	(3)	125	
	470	16	16.5	J16	500	0.18	0.12	EEVTG1J471M	(3)	125	
80	10	8	10.2	F	70	1.30	0.12	EEETG1K100P	(2)	500	
	22	8	10.2	(F)	70	1.30	0.12	EEETG1K220UP	(2)	500	
		10	10.2	G	90	1.00	0.12	EEETG1K220P	(2)	500	
	33	8	10.2	(F)	70	1.30	0.12	EEETG1K330UP	(2)	500	
		10	10.2	G	90	1.00	0.12	EEETG1K330P	(2)	500	
	47	10	10.2	(G)	90	1.00	0.12	EEETG1K470UP	(2)	500	
		12.5	13.5	H13	250	0.42	0.12	EEVTG1K470Q	(3)	200	
	100	12.5	13.5	(H13)	250	0.42	0.12	EEVTG1K101UQ	(3)	200	
		16	16.5	J16	350	0.30	0.12	EEVTG1K101M	(3)	125	
	220	16	16.5	(J16)	350	0.30	0.12	EEVTG1K221UM	(3)	125	
		18	16.5	K16	400	0.28	0.12	EEVTG1K221M	(3)	125	
330	16	16.5	(J16)	350	0.30	0.12	EEVTG1K331UM	(3)	125		
	18	16.5	K16	400	0.28	0.12	EEVTG1K331M	(3)	125		
470	18	16.5	K16	400	0.28	0.12	EEVTG1K471M	(3)	125		
100	10	8	10.2	F	70	1.30	0.10	EEETG2A100P	(2)	500	
	22	8	10.2	(F)	70	1.30	0.10	EEETG2A220UP	(2)	500	
		10	10.2	G	90	1.00	0.10	EEETG2A220P	(2)	500	
	33	10	10.2	G	90	1.00	0.10	EEETG2A330P	(2)	500	
	47	12.5	13.5	H13	250	0.42	0.10	EEVTG2A470Q	(3)	200	
	100	16	16.5	J16	350	0.30	0.10	EEVTG2A101M	(3)	125	
	220	18	16.5	K16	400	0.28	0.10	EEVTG2A221M	(3)	125	
330	18	16.5	K16	400	0.28	0.10	EEVTG2A331M	(3)	125		

* Size code() : Miniaturization product

· Please refer to the page of "Reflow Profile" and "The Taping Dimensions".

· When requesting vibration-proof product, please put the last "V" instead to "P", "Q", or "M"

Surface Mount Type

Series : Medium-size **TK** Type : **V**
High temperature
Lead-Free reflow (suffix : A*)



Features

- Endurance : 125 °C 2000 h
- Vibration-proof product is available upon request.
- RoHS compliant

Specifications

Category temperature range	-40 °C to +125 °C									
Rated voltage range	10 V.DC to 100 V.DC									
Capacitance range	47 μF to 4700 μF									
Capacitance tolerance	±20 % (120 Hz/+20 °C)									
Leakage current	I ≤ 0.01 CV After 2 minutes									
Dissipation factor (tan δ)	Please see the attached characteristics list									
Characteristics at low temperature	V.DC	10	16	25	35	50	63	80	100	(Impedance ratio at 120 Hz)
	Z(-25 °C)/Z(+20 °C)	3	2	2	2	2	2	2	2	
	Z(-40 °C)/Z(+20 °C)	6	4	4	3	3	3	3	3	
Endurance	After applying rated working voltage for 2000 hours at +125 °C±2 °C and then being stabilized at +20 °C, Capacitors shall meet the following limits.									
	Capacitance change	Within ±30 % of the initial value (Miniaturization product : Within ±35 %)								
	tan δ	≤300 % of the initial limit (Miniaturization product : Within 350 %)								
Shelf life	After storage for 1000 hours at +125 °C±2 °C with no voltage applied and then being stabilized at +20 °C, capacitors shall meet the limits specified in Endurance.(With voltage treatment)									
	After reflow soldering and then being stabilized at +20 °C, capacitors shall meet the following limits.									
Resistance to soldering heat	Capacitance change	Within ±10 % of the initial value								
	tan δ	Within the initial limit								
	DC leakage current	Within the initial limit								
AEC-Q200	AEC-Q200 compliant									

Frequency correction factor for ripple current

Frequency (Hz)	120	1 k	10 k	100 k to
Correction factor	0.75	0.90	0.95	1.00

Marking

Example : 10 V.DC 1000 μF
 Marking color : BLACK

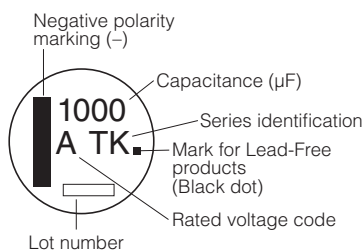

R. Voltage (V.DC)	10	16	25	35	50	63	80	100
Code	A	C	E	V	H	J	K	2A

Dimensions

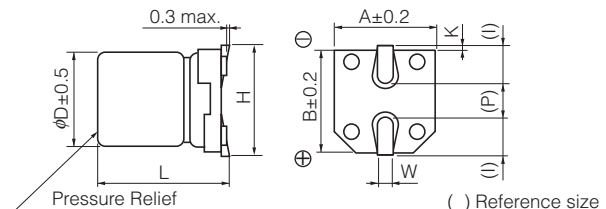

(Unit : mm)

Size code	φD	L	A, B	H	I	W	P	K
H13	12.5	13.5±0.5	13.5	15.0 max.	4.7	0.90±0.3	4.4	0.70±0.3
J16	16.0	16.5±0.5	17.0	19.0 max.	5.5	1.20±0.3	6.7	0.70±0.3
K16	18.0	16.5±0.5	19.0	21.0 max.	6.7	1.20±0.3	6.7	0.70±0.3

Characteristics list

Endurance : 125 °C 2000 h

Rated voltage (V.DC)	Cap. (±20 %) (μF)	Case size (mm)		Size* code	Specification			Part No.	Reflow	Min. Packaging Qty	
		φD	L		Ripple current (100 kHz) (+125 °C) (mA r.m.s.)	ESR (100 kHz) (Ω)				tan δ (120 Hz) (+20 °C)	Taping (pcs)
						+20 °C	-40 °C				
10	1000	12.5	13.5	H13	800	0.120	1.80	0.30	EEETK1A102AQ	(9)	200
	1500	12.5	13.5	(H13)	800	0.120	1.80	0.30	EEETKA152UAQ	(9)	200
	2200	16	16.5	J16	1100	0.080	1.20	0.32	EEETK1A222AM	(9)	125
	3300	16	16.5	(J16)	1100	0.080	1.20	0.34	EEETKA332UAM	(9)	125
		18	16.5	K16	1300	0.075	1.10	0.36	EEETK1A332AM	(9)	125
	4700	18	16.5	K16	1300	0.075	1.10	0.38	EEETK1A472AM	(9)	125
16	330	12.5	13.5	H13	800	0.120	1.80	0.23	EEETK1C331AQ	(9)	200
	470	12.5	13.5	H13	800	0.120	1.80	0.23	EEETK1C471AQ	(9)	200
	680	12.5	13.5	H13	800	0.120	1.80	0.23	EEETK1C681AQ	(9)	200
	1000	12.5	13.5	(H13)	800	0.120	1.80	0.23	EEETKC102UAQ	(9)	200
		16	16.5	J16	1100	0.080	1.20	0.25	EEETK1C102AM	(9)	125
	2200	16	16.5	(J16)	1100	0.080	1.20	0.27	EEETKC222UAM	(9)	125
		18	16.5	K16	1300	0.075	1.10	0.27	EEETK1C222AM	(9)	125
3300	18	16.5	K16	1300	0.075	1.10	0.29	EEETK1C332AM	(9)	125	
25	330	12.5	13.5	H13	800	0.120	1.80	0.18	EEETK1E331AQ	(9)	200
	470	12.5	13.5	H13	800	0.120	1.80	0.18	EEETK1E471AQ	(9)	200
	680	12.5	13.5	(H13)	800	0.120	1.80	0.18	EEETKE681UAQ	(9)	200
		16	16.5	J16	1100	0.080	1.20	0.18	EEETK1E681AM	(9)	125
	1000	16	16.5	(J16)	1100	0.080	1.20	0.18	EEETKE102UAM	(9)	125
		18	16.5	K16	1300	0.075	1.10	0.18	EEETK1E102AM	(9)	125
	2200	18	16.5	K16	1300	0.075	1.10	0.20	EEETK1E222AM	(9)	125
35	330	12.5	13.5	H13	800	0.120	1.80	0.16	EEETK1V331AQ	(9)	200
	470	12.5	13.5	(H13)	800	0.120	1.80	0.16	EEETKV471UAQ	(9)	200
		16	16.5	J16	1100	0.080	1.20	0.16	EEETK1V471AM	(9)	125
	680	16	16.5	(J16)	1100	0.080	1.20	0.16	EEETKV681UAM	(9)	125
		18	16.5	K16	1300	0.075	1.10	0.16	EEETK1V681AM	(9)	125
	1000	18	16.5	K16	1300	0.075	1.10	0.16	EEETK1V102AM	(9)	125
50	220	12.5	13.5	H13	600	0.230	3.40	0.14	EEETK1H221AQ	(10)	200
	330	12.5	13.5	H13	600	0.230	3.40	0.14	EEETK1H331AQ	(10)	200
	470	16	16.5	J16	900	0.150	2.20	0.14	EEETK1H471AM	(10)	125
		16	16.5	(J16)	900	0.150	2.20	0.14	EEETKH681UAM	(10)	125
	680	18	16.5	K16	950	0.140	2.10	0.14	EEETK1H681AM	(10)	125
		1000	18	16.5	K16	950	0.140	2.10	0.14	EEETK1H102AM	(10)
63	100	12.5	13.5	H13	350	0.260	5.20	0.12	EEETK1J101AQ	(11)	200
	220	12.5	13.5	H13	350	0.260	5.20	0.12	EEETK1J221AQ	(11)	200
	330	16	16.5	J16	500	0.180	3.60	0.12	EEETK1J331AM	(11)	125
	470	16	16.5	J16	500	0.180	3.60	0.12	EEETK1J471AM	(11)	125
80	47	12.5	13.5	H13	250	0.420	8.40	0.12	EEETK1K470AQ	(11)	200
	100	12.5	13.5	(H13)	250	0.420	8.40	0.12	EEETKK101UAQ	(11)	200
		16	16.5	J16	350	0.300	6.00	0.12	EEETK1K101AM	(11)	125
	220	16	16.5	(J16)	350	0.300	6.00	0.12	EEETKK221UAM	(11)	125
		18	16.5	K16	400	0.280	5.60	0.12	EEETK1K221AM	(11)	125
	330	16	16.5	(J16)	350	0.300	6.00	0.12	EEETKK331UAM	(11)	125
		18	16.5	K16	400	0.280	5.60	0.12	EEETK1K331AM	(11)	125
470	18	16.5	K16	400	0.280	5.60	0.12	EEETK1K471AM	(11)	125	
100	47	12.5	13.5	H13	250	0.420	8.40	0.10	EEETK2A470AQ	(11)	200
	100	16	16.5	J16	350	0.300	6.00	0.10	EEETK2A101AM	(11)	125
	220	18	16.5	K16	400	0.280	5.60	0.10	EEETK2A221AM	(11)	125
	330	18	16.5	K16	400	0.280	5.60	0.10	EEETK2A331AM	(11)	125

* Size code() : Miniaturization product

· Please refer to the page of "Reflow Profile" and "The Taping Dimensions".

· When requesting vibration-proof product, please put the last "V" instead to "Q" or "M"

Surface Mount Type

Series : **TK** Type : **V**



Features

- Endurance : 125 °C 3000 h
- Low ESR at -40 °C (50 % lower than TG series)
- Added ESR specification after the endurance test
- Vibration-proof product is available upon request.
- RoHS compliant

Specifications

Category temperature range	-40 °C to +125 °C					
Rated voltage range	10 V.DC to 35 V.DC					
Capacitance range	47 μF to 470 μF					
Capacitance tolerance	±20 % (120 Hz/+20 °C)					
Leakage current	$I \leq 0.01 CV$ After 2 minutes					
Dissipation factor (tan δ)	Please see the attached characteristics list					
Characteristics at low temperature	V.DC	10	16	25	35	(Impedance ratio at 120 Hz)
	Z(-25 °C)/Z(+20 °C)	3	2	2	2	
	Z(-40 °C)/Z(+20 °C)	4	3	3	3	
Endurance	After the life test with DC rated working voltage at +125 °C ±2 °C for 3000 hours, the capacitors shall meet the limits specified below.					
	Capacitance change	Within ±30 % of the initial value (code U : ±35 %)				
	tan δ	≤300 % of the initial limit (code U : ±350 %)				
	DC leakage current	Within the initial limit				
Shelf life	After storage for 1000 hours at +125 °C±2 °C with no voltage applied and then being stabilized at +20 °C, capacitors shall meet the limits specified in Endurance. (With voltage treatment)					
ESR after the life test	After the life test with DC rated working voltage at +125 °C±2 °C for 3000 hours, ESR value shall meet the specified below.					
	After 1000 hours	20 °C	≤ 150 % of the initial limit			
		-40 °C	≤ 200 % of the initial limit			
	After 2000 hours	20 °C	≤ 300 % of the initial limit			
		-40 °C	≤ 400 % of the initial limit			
	After 3000 hours	20 °C	≤ 1000 % of the initial limit			
-40 °C		≤ 1500 % of the initial limit				
AEC-Q200	AEC-Q200 compliant					

Frequency correction factor for ripple current

Frequency (Hz)	120	1 k	10 k	100 k to
Correction factor	0.65	0.85	0.95	1.00

Marking

Example : 10 V.DC 220 μF
Marking color : BLACK

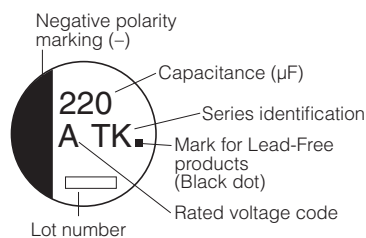

R. Voltage (V.DC)	10	16	25	35
Code	A	C	E	V

Dimensions

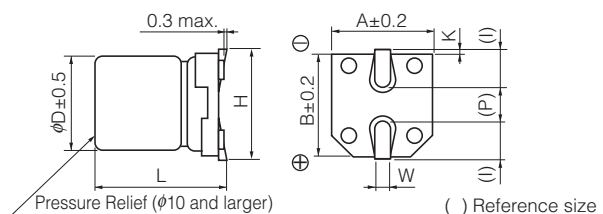

(Unit : mm)

Size code	φD	L	A, B	H	I	W	P	K
F	8.0	10.2±0.3	8.3	10.0 max.	3.4	0.90±0.2	3.1	0.70±0.2
G	10.0	10.2±0.3	10.3	12.0 max.	3.5	0.90±0.2	4.6	0.70±0.2

Characteristics list

Endurance : 125 °C 3000 h

Rated voltage (V.DC)	Cap. (±20 %) (μF)	Case size (mm)		Size* code	Specification			Part No.	Reflow	Min. Packaging Qty	
		φD	L		Ripple current (100 kHz) (+125 °C) (mA r.m.s.)	ESR (100 kHz) (Ω)				tan δ (120 Hz) (+20 °C)	Taping (pcs)
						+20 °C	-40 °C				
10	220	8	10.2	F	197	0.3	5	0.30	EEETK1A221P	(8)	500
	330	8	10.2	(F)	197	0.3	5	0.30	EEETK1A331UP	(8)	500
		10	10.2	G	270	0.2	3	0.30	EEETK1A331P	(8)	500
	470	10	10.2	(G)	270	0.2	3	0.30	EEETK1A471UP	(8)	500
16	100	8	10.2	F	197	0.3	5	0.23	EEETK1C101P	(8)	500
	220	8	10.2	(F)	197	0.3	5	0.23	EEETK1C221UP	(8)	500
		10	10.2	G	270	0.2	3	0.23	EEETK1C221P	(8)	500
	330	10	10.2	(G)	270	0.2	3	0.23	EEETK1C331UP	(8)	500
25	100	8	10.2	F	197	0.3	5	0.18	EEETK1E101P	(8)	500
	220	8	10.2	(F)	197	0.3	5	0.18	EEETK1E221UP	(8)	500
		10	10.2	G	270	0.2	3	0.18	EEETK1E221P	(8)	500
	330	10	10.2	(G)	270	0.2	3	0.18	EEETK1E331UP	(8)	500
35	47	8	10.2	F	197	0.3	5	0.16	EEETK1V470P	(8)	500
	100	8	10.2	(F)	197	0.3	5	0.16	EEETK1V101UP	(8)	500
		10	10.2	G	270	0.2	3	0.16	EEETK1V101P	(8)	500
	220	10	10.2	(G)	270	0.2	3	0.16	EEETK1V221UP	(8)	500

- * Size code() : Miniaturization product
- Please refer to the page of "Reflow Profile" and "The Taping Dimensions".
- When requesting vibration-proof product, please put the last "V" instead to "P"

Surface Mount Type

Series : **TP** Type : **V**

High temperature

Lead-Free reflow (suffix : A*)



Features

- Lower ESR at Low temperature after endurance
- Endurance : 125 °C 3000 h (D8 size : 2000 h)
- Automotive
- Vibration-proof product is available upon request. ($\phi 8$ mm and larger)
- RoHS compliant

Specifications

Category temperature range	-40 °C to +125 °C			
Rated voltage range	10 V.DC to 35 V.DC			
Capacitance range	47 μ F to 470 μ F			
Capacitance tolerance	± 20 % (120 Hz/+20 °C)			
Leakage current	$I \leq 0.01 CV$ (μ A) After 2 minutes			
Dissipation factor (tan δ)	Please see the attached characteristics list			
Endurance	After the life test with DC rated working voltage at +125 °C ± 2 °C for 3000 hours (D8 size : 2000 h). the capacitors shall meet the limits specified below.			
	Capacitance change	Within ± 30 % of the initial value		
	tan δ	≤ 300 % of the initial limit		
	DC leakage current	Within the initial limit		
	ESR after endurance ($\Omega/100$ kHz)		Size Code	
D8			F	G
Initial (+20 °C)			0.45	0.2
After 2000 h (-40 °C)	40	4.5	3.5	
Shelf life	After storage for 1000 hours at +125 °C ± 2 °C with no voltage applied and then being stabilized at +20 °C, capacitors shall meet the limits specified in Endurance (With voltage treatment)			
Resistance to soldering heat	After reflow soldering and then being stabilized at +20 °C, capacitors shall meet the following limits.			
	Capacitance change	Within ± 10 % of the initial value		
	tan δ	Within the initial limit		
DC leakage current	Within the initial limit			
AEC-Q200	AEC-Q200 compliant			

Frequency correction factor for ripple current

Frequency (Hz)	120	1 k	10 k	100 k to
Correction factor	0.65	0.85	0.95	1.00

Marking

Example : 10 V.DC 220 μ F
Marking color : BLACK

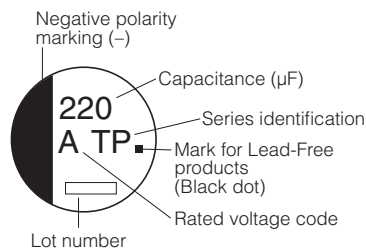

R. Voltage (V.DC)	10	16	25	35
Code	A	C	E	V

Dimensions

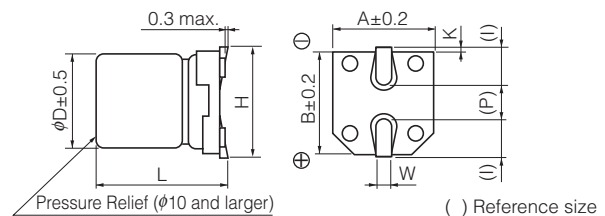

(Unit : mm)

Size code	ϕD	L	A, B	H	I	W	P	K
D8	6.3	7.7 ± 0.3	6.6	7.8 max.	2.6	0.65 ± 0.1	1.8	0.35 $^{+0.15}_{-0.20}$
F	8.0	10.2 ± 0.3	8.3	10.0 max.	3.4	0.90 ± 0.2	3.1	0.70 ± 0.20
G	10.0	10.2 ± 0.3	10.3	12.0 max.	3.5	0.90 ± 0.2	4.6	0.70 ± 0.20

Characteristics list

Endurance : 125 °C 3000 h ($\phi 6.3 \times 7.7$: 2000 h)

Rated voltage (V.DC)	Cap. ($\pm 20\%$) (μF)	Case size (mm)		Size* code	Specification			Part No.	Reflow	Min. Packaging Qty	
		ϕD	L		Ripple current (100 kHz) (+125 °C) (mA r.m.s.)	ESR (100 kHz) (Ω)				$\tan \delta$ (120 Hz) (+20 °C)	Taping (pcs)
						+20 °C	-40 °C				
10	220	8	10.2	F	270	0.20	3	0.30	EEETP1A221AP	(8)	500
	330	8	10.2	(F)	270	0.20	3	0.30	EEETPA331UAP	(8)	500
		10	10.2	G	500	0.15	2	0.30	EEETP1A331AP	(8)	500
		470	10	10.2	G	500	0.15	2	0.30	EEETP1A471AP	(8)
16	100	6.3	7.7	D8	197	0.45	5	0.23	EEETPC101XAP	(8)	900
		8	10.2	F	270	0.20	3	0.23	EEETP1C101AP	(8)	500
	220	8	10.2	F	270	0.20	3	0.23	EEETP1C221AP	(8)	500
	330	10	10.2	G	500	0.15	2	0.23	EEETP1C331AP	(8)	500
	470	10	10.2	G	500	0.15	2	0.23	EEETP1C471AP	(8)	500
	25	100	8	10.2	F	270	0.20	3	0.18	EEETP1E101AP	(8)
220		10	10.2	G	500	0.15	2	0.18	EEETP1E221AP	(8)	500
330		10	10.2	G	500	0.15	2	0.18	EEETP1E331AP	(8)	500
35	47	6.3	7.7	D8	197	0.45	5	0.16	EEETPV470XAP	(8)	900
		8	10.2	F	270	0.20	3	0.16	EEETP1V470AP	(8)	500
	100	8	10.2	F	270	0.20	3	0.16	EEETP1V101AP	(8)	500
	220	10	10.2	G	500	0.15	2	0.16	EEETP1V221AP	(8)	500

* Size code() : Miniaturization product

If Part number exceeds 12 digits, voltage code is abbreviated as follows; 0J → J, 1A → A, 1C → C, 1E → E, 1V → V

· Please refer to the page of "Reflow Profile" and "The Taping Dimensions".

· When requesting vibration-proof product, please put the last "V" instead to "P"

Surface Mount Type

Series : Medium-size **TP** Type : **V**
High temperature
Lead-Free reflow



Features

- High ripple current (2 to 5 times as high as TK series)
- Low ESR (40 to 70 % lower than TK series)
- Large capacitance (Up to 80 % larger than TK series)
- Endurance : 3000 to 4000 h at 125 °C
- Vibration-proof product is available upon request
- RoHS directive compliant

Specifications

Category temperature range	-55 °C to +125 °C		
Rated voltage range	25 V.DC to 80 V.DC		
Capacitance range	390 μF to 3300 μF		
Capacitance tolerance	±20 % (120 Hz/+20 °C)		
Leakage current	I ≤ 0.01 CV (μA) after 2 minutes		
Dissipation factor (tan δ)	Please see the attached characteristics list		
Characteristics at low temperature	V.DC	25	35 to 80
	Z(-25 °C)/Z(+20 °C)	2	2
	Z(-40 °C)/Z(+20 °C)	4	3
(Impedance ratio at 120 Hz)			
Endurance	After applying rated working voltage for 4000 hours at +125 °C±2 °C and then being stabilized at +20 °C, Capacitors shall meet the following limits. (J16, K16 size : 3000 h)		
	Capacitance change	Within ±30 % of the initial value (35 V.DC or less : Within ±35 %)	
	tan δ	≤ 300 % of the initial limit	
	DC leakage current	Within the initial limit	
Shelf life	After storage for 1000 hours at +125 °C±2 °C with no voltage applied and then being stabilized at +20 °C, capacitors shall meet the limits specified in Endurance.(With voltage treatment)		
Resistance to soldering heat	After reflow soldering and then being stabilized at +20 °C, capacitors shall meet the following limits.		
	Capacitance change	Within ±10 % of the initial value	
	tan δ	Within the initial limit	
	DC leakage current	Within the initial limit	
AEC-Q200	AEC-Q200 compliant		

Frequency correction factor for ripple current

Frequency (Hz)	120	1 k	10 k	100 k to
Correction factor	0.75	0.90	0.95	1.00

Marking

Example : 25 V.DC 1800 μF
 Marking color : BLACK

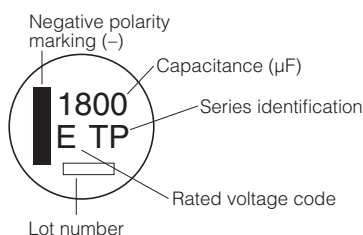

R. Voltage (V.DC)	25	35	50	63	70	80
Code	E	V	H	J	70	K

Dimensions

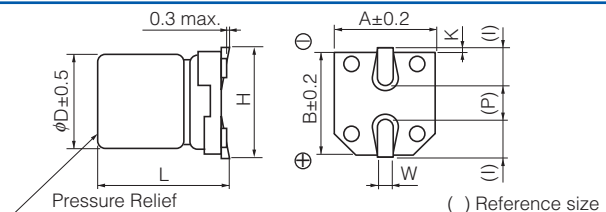

Size codev	φD	L	A, B	H	I	W	P	K
J16	16.0	16.5±0.5	17.0	19.0 max.	5.5	1.20±0.3	6.7	0.70±0.30
K16	18.0	16.5±0.5	19.0	21.0 max.	6.7	1.20±0.3	6.7	0.70±0.30
K21	18.0	21.5±0.5	19.0	21.0 max.	6.7	1.20±0.3	6.7	0.70±0.30

The dimensions of the vibration-proof products, please refer to the page of the mounting specification.

Characteristics list

Endurance : 125 °C 4000 h (J16, K16 size : 3000 h)

Rated voltage (V.DC)	Cap. (±20 %) (μF)	Case size (mm) *Standard product		Size code	Specification			Part No.		Reflow	Min. Packaging Q'ty Taping (pcs)
		φD	L		Ripple current (100 kHz) (+125 °C) (mA r.m.s.)	ESR (100 kHz) (+20 °C) (Ω)	tan δ (120 Hz) (+20 °C)	Standard Product	Vibration-proof Product		
25	1800	16	16.5	J16	2400	0.047	0.18	EEETP1E182M	EEETP1E182V	(9)	125
	2700	18	16.5	K16	2600	0.045	0.20	EEETP1E272M	EEETP1E272V	(9)	125
	3300	18	21.5	K21	3250	0.032	0.22	EEETP1E332M	EEETP1E332V	(9)	75
35	1300	16	16.5	J16	2400	0.047	0.16	EEETP1V132M	EEETP1V132V	(9)	125
	1800	18	16.5	K16	2600	0.045	0.16	EEETP1V182M	EEETP1V182V	(9)	125
	2400	18	21.5	K21	3250	0.032	0.18	EEETP1V242M	EEETP1V242V	(9)	75
50	750	16	16.5	J16	2000	0.080	0.14	EEETP1H751M	EEETP1H751V	(10)	125
	1000	18	16.5	K16	2100	0.078	0.14	EEETP1H102M	EEETP1H102V	(10)	125
	1300	18	21.5	K21	2900	0.060	0.14	EEETP1H132M	EEETP1H132V	(10)	75
63	560	16	16.5	J16	1900	0.100	0.12	EEETP1J561M	EEETP1J561V	(11)	125
	750	18	16.5	K16	2000	0.095	0.12	EEETP1J751M	EEETP1J751V	(11)	125
	1000	18	21.5	K21	2600	0.068	0.12	EEETP1J102M	EEETP1J102V	(11)	75
70	470	16	16.5	J16	1900	0.100	0.12	EEETP70471M	EEETP70471V	(11)	125
	680	18	16.5	K16	2000	0.095	0.12	EEETP70681M	EEETP70681V	(11)	125
	820	18	21.5	K21	2600	0.068	0.12	EEETP70821M	EEETP70821V	(11)	75
80	390	16	16.5	J16	1900	0.100	0.12	EEETP1K391M	EEETP1K391V	(11)	125
	510	18	16.5	K16	2000	0.095	0.12	EEETP1K511M	EEETP1K511V	(11)	125
	680	18	21.5	K21	2600	0.068	0.12	EEETP1K681M	EEETP1K681V	(11)	75

- Please refer to the page of "Reflow Profile" and "The Taping Dimensions".
- The dimensions of the vibration-proof products, please refer to the page of the mounting specification.

Surface Mount Type

Series : **TC** Type : **V**

High temperature Lead-Free reflow



Features

- High ripple current (50 % higher than TP series)
- Endurance: 3000 h at 125 °C (D8 size: 2000 h)
- Added ESR specification after the endurance test
- Vibration-proof product is available upon request. ($\phi 8$ mm and larger)
- RoHS directive compliant

Specifications

Category temp. range	-40 °C to +125 °C			
Rated voltage range	10 V.DC to 35 V.DC			
Nominal cap. range	47 μ F to 470 μ F			
Capacitance tolerance	± 20 % (120 Hz/+20 °C)			
DC Leakage current	$I \leq 0.01$ CV (μ A) After 2 minutes			
Dissipation factor (tan δ)	Please see the attached characteristics list			
Endurance	After applying rated working voltage for 3000 hours (D8 size : 2000 h) at +125 °C ± 2 °C and then being stabilized at +20 °C, Capacitors shall meet the following limits.			
	Capacitance change	± 30 % of initial measured value		
	tan δ	≤ 300 % of initial specified value		
	DC leakage current	\leq initial specified value		
	ESR after Endurance ($\Omega/100$ kHz)		Size code	
D8			F	G
Initial (+20 °C)			0.45	0.2
After 2000 h (-40 °C)	40	4.5	3.5	
Shelf life	After storage for 1000 hours at +125 °C ± 2 °C with no voltage applied and then being stabilized at +20 °C, capacitors shall meet the limits specified in Endurance (With voltage treatment)			
Resistance to soldering heat	After reflow soldering and then being stabilized at +20 °C, capacitors shall meet the following limits.			
	Capacitance change	± 10 % of initial measured value		
	tan δ	\leq initial specified value		
DC leakage current	\leq initial specified value			
AEC-Q200	AEC-Q200 compliant			

Frequency correction factor for ripple current

Frequency (Hz)	120	1 k	10 k	100 k to
Correction factor	0.65	0.85	0.95	1.00

Marking

Example : 10 V.DC 220 μ F
Marking color : BLACK

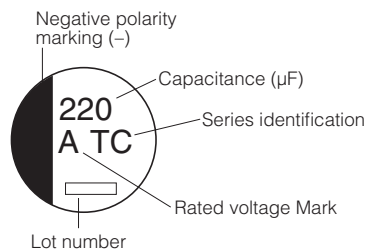

R. Voltage (V.DC)	10	16	25	35
Code	A	C	E	V

Dimensions (not to scale)

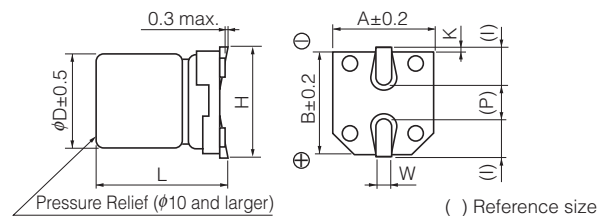

(Unit : mm)

Size code	ϕD	L	A, B	H	I	W	P	K
D8	6.3	7.7 ± 0.3	6.6	7.8 max.	2.6	0.65 ± 0.1	1.8	0.35 $^{+0.15}_{-0.20}$
F	8.0	10.2 ± 0.3	8.3	10.0 max.	3.4	0.90 ± 0.2	3.1	0.70 ± 0.20
G	10.0	10.2 ± 0.3	10.3	12.0 max.	3.5	0.90 ± 0.2	4.6	0.70 ± 0.20

Characteristics list

Endurance : 125 °C 3000 h (D8 size : 2000 h)

Rated voltage (V.DC)	Cap. (±20 %) (μF)	Case size (mm)		Size code	Specification				Part No.	Reflow	Min. Packaging Q'ty	
		φD	L		Ripple Current (100 kHz) (+125 °C) (mA r.m.s.)	ESR (100 kHz) (Ω)		tan δ (120 Hz) (+20 °C)			Taping (pcs)	
						+20 °C	-40 °C					
10	220	8	10.2	F	410	0.20	3	0.30	EEETC1A221P	(8)	500	
	330	10	10.2	G	750	0.15	2	0.30	EEETC1A331P	(8)	500	
	470	10	10.2	G	750	0.15	2	0.30	EEETC1A471P	(8)	500	
16	100	6.3	7.7	D8	300	0.45	5	0.23	EEETC1C101XP	(8)	900	
		8	10.2	F	410	0.20	3	0.23	EEETC1C101P	(8)	500	
	220	8	10.2	F	410	0.20	3	0.23	EEETC1C221P	(8)	500	
	330	10	10.2	G	750	0.15	2	0.23	EEETC1C331P	(8)	500	
	470	10	10.2	G	750	0.15	2	0.23	EEETC1C471P	(8)	500	
	25	100	8	10.2	F	410	0.20	3	0.18	EEETC1E101P	(8)	500
220		10	10.2	G	750	0.15	2	0.18	EEETC1E221P	(8)	500	
330		10	10.2	G	750	0.15	2	0.18	EEETC1E331P	(8)	500	
35	47	6.3	7.7	D8	300	0.45	5	0.16	EEETC1V470XP	(8)	900	
		8	10.2	F	410	0.20	3	0.16	EEETC1V470P	(8)	500	
	100	8	10.2	F	410	0.20	3	0.16	EEETC1V101P	(8)	500	
	220	10	10.2	G	750	0.15	2	0.16	EEETC1V221P	(8)	500	

- Please refer to the page of "Reflow Profile" and "The Taping Dimensions".
- When requesting vibration-proof product, please put the last "V" instead to "P"

Surface Mount Type

Series : **TCU** Type : **V**

High temperature Lead-Free reflow



Features

- Miniaturization (20 % to 40 % less than TP series)
- Endurance: 3000 h at 125 °C
- Added ESR specification after the endurance test
- Vibration-proof product is available upon request
- RoHS directive compliant

Specifications

Category temp. range	-40 °C to +125 °C		
Rated voltage range	10 V.DC to 35 V.DC		
Nominal cap. range	220 μF to 680 μF		
Capacitance tolerance	±20 % (120 Hz/+20 °C)		
DC Leakage current	I ≤ 0.01 CV (μA) After 2 minutes		
Dissipation factor (tan δ)	Please see the attached characteristics list		
Endurance	After applying rated working voltage for 3000 hours at +125 °C±2 °C and then being stabilized at +20 °C, Capacitors shall meet the following limits.		
	Capacitance change	±30 % of initial measured value	
	tan δ	≤ 300 % of initial specified value	
	DC leakage current	≤ initial specified value	
	ESR after Endurance (Ω/100kHz)		
		F G	
Initial (+20 °C)		0.2	0.15
After 2000 h (-40 °C)	9	7	
Shelf life	After storage for 1000 hours at +125 °C±2 °C with no voltage applied and then being stabilized at +20 °C, capacitors shall meet the limits specified in Endurance (With voltage treatment)		
Resistance to soldering heat	After reflow soldering and then being stabilized at +20 °C, capacitors shall meet the following limits.		
	Capacitance change	±10 % of initial measured value	
	tan δ	≤ initial specified value	
DC leakage current	≤ initial specified value		
AEC-Q200	AEC-Q200 compliant		

Frequency correction factor for ripple current

Frequency (Hz)	120	1 k	10 k	100 k to
Correction factor	0.65	0.85	0.95	1.00

Marking

Example : 10 V.DC 330 μF
Marking color : BLACK

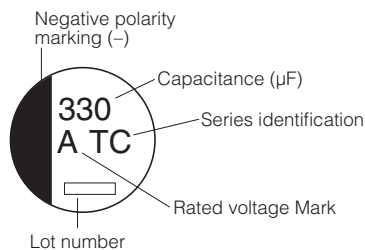

R. Voltage (V.DC)	10	16	25	35
Code	A	C	E	V

Dimensions (not to scale)

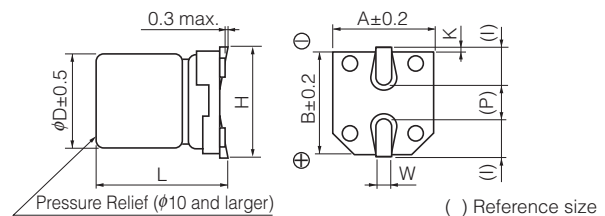

(Unit : mm)

Size code	φD	L	A, B	H	I	W	P	K
F	8.0	10.2±0.3	8.3	10.0max.	3.4	0.90±0.2	3.1	0.70±0.20
G	10.0	10.2±0.3	10.3	12.0max.	3.5	0.90±0.2	4.6	0.70±0.20

Characteristics list

Endurance : 125 °C 3000 h

Rated voltage (V.DC)	Cap. (±20 %) (μF)	Case size (mm)		Size code	Specification			Part No.	Reflow	Min. Packaging Qty	
		φD	L		Ripple Current (100 kHz) (+125 °C) (mA r.m.s.)	ESR (100 kHz) (Ω)				tan δ (120 Hz) (+20 °C)	Taping (pcs)
						+20 °C	-40 °C				
10	330	8	10.2	F	410	0.20	3	0.30	EEETC1A331UP	(8)	500
	470	8	10.2	F	410	0.20	3	0.30	EEETC1A471UP	(8)	500
	560	8	10.2	F	410	0.20	3	0.30	EEETC1A561UP	(8)	500
	680	10	10.2	G	750	0.15	2	0.30	EEETC1A681UP	(8)	500
16	330	8	10.2	F	410	0.20	3	0.23	EEETC1C331UP	(8)	500
	390	8	10.2	F	410	0.20	3	0.23	EEETC1C391UP	(8)	500
	680	10	10.2	G	750	0.15	2	0.23	EEETC1C681UP	(8)	500
25	220	8	10.2	F	410	0.20	3	0.18	EEETC1E221UP	(8)	500
	330	8	10.2	F	410	0.20	3	0.18	EEETC1E331UP	(8)	500
	470	10	10.2	G	750	0.15	2	0.18	EEETC1E471UP	(8)	500
35	220	8	10.2	F	410	0.20	3	0.16	EEETC1V221UP	(8)	500
	330	10	10.2	G	750	0.15	2	0.16	EEETC1V331UP	(8)	500
	390	10	10.2	G	750	0.15	2	0.16	EEETC1V391UP	(8)	500

- Please refer to the page of "Reflow Profile" and "The Taping Dimensions".
- When requesting vibration-proof product, please put the last "V" instead to "P"

Surface Mount Type

Series : **TQ** Type : **V**
High temperature
Lead-Free reflow (suffix : A*)



Features

- 1 size smaller and same performance compare with V-TK series
- Low ESR (85 % low ESR in low temperature after endurance compare with V-TP series)
- Endurance : 125 °C 2000 h
- RoHS compliant

Recommended applications

- Automotive

Specifications

Category temperature range	-40 °C to +125 °C		
Rated voltage range	35 V.DC		
Capacitance range	47 µF to 100 µF		
Capacitance tolerance	±20 % (120 Hz/+20 °C)		
Leakage current	I ≤ 0.01 CV (µA) After 2 minutes		
Dissipation factor (tan δ)	Please see the attached characteristics list		
Endurance	After the life test with DC rated working voltage at +125 °C±2 °C for 2000 hours, the capacitors shall meet the limits specified below.		
	Capacitance change	Within ±30 % of the initial value	
	tan δ	≤300 % of the initial limit	
	DC leakage current	Within the initial limit	
	ESR after endurance (Ω/100kHz)		Size Code
Initial (+20 °C)			0.30
		After 2000 h (-40 °C)	6
Shelf life	After storage for 1000 hours at +125 °C±2 °C with no voltage applied and then being stabilized at +20 °C, capacitors shall meet the limits specified in Endurance. (With voltage treatment)		
Resistance to soldering heat	After reflow soldering and then being stabilized at +20 °C, capacitors shall meet the following limits.		
	Capacitance change	Within ±10 % of the initial value	
	tan δ	Within the initial limit	
	DC leakage current	Within the initial limit	
AEC-Q200	AEC-Q200 compliant		

Frequency correction factor for ripple current

Frequency (Hz)	120	1 k	10 k	100 k to
Correction factor	0.65	0.85	0.95	1.00

Marking

Example : 35 V.DC 47 µF
 Marking color : BLACK

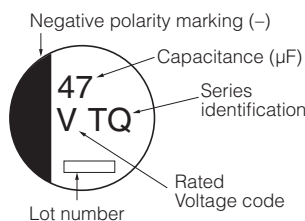

R. Voltage (V.DC)	35
Code	V

Dimensions

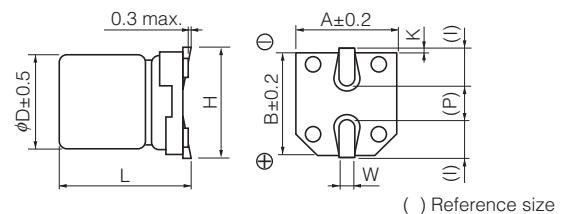

(Unit : mm)

Size code	φD	L	A, B	H	I	W	P	K
D8	6.3	7.7±0.3	6.6	7.8 max.	2.6	0.65±0.1	1.8	0.35 ^{+0.15} _{0.20}

Characteristics list

Endurance : 125 °C 2000 h

Rated voltage (V.DC)	Cap. (±20 %) (μF)	Case size (mm)		Size code	Specification			Part No.	Reflow	Min. Packaging Qty
		φD	L		Ripple current (100 kHz) (+125 °C) (mA r.m.s.)	ESR (100 kHz) (+20 °C) (Ω)	tan δ (120 Hz) (+20 °C)			Taping (pcs)
35	47	6.3	7.7	D8	197	0.30	0.16	EEETQV470XAP	(5)	900
	100	6.3	7.7	D8	197	0.30	0.16	EEETQV101XAP	(5)	900

If Part number exceeds 12 digits, voltage code is abbreviated as follows; 1V → V
 · Please refer to the page of "Reflow Profile" and "The Taping Dimensions".

Surface Mount Type

Series : **EB** (Large Can Size) Type : **V**



Features

- Endurance : 105 °C 3000 h to 5000 h
- RoHS compliant

Specifications

Category temperature range	-25 °C to +105 °C							
Rated voltage range	160 V.DC to 450 V.DC							
Capacitance range	2.2 μF to 100 μF							
Capacitance tolerance	±20 % (120 Hz/+20 °C)							
Leakage current	I ≤ 0.06 CV + 10 (μA) After 2 minutes							
Dissipation factor (tan δ)	Please see the attached characteristics list							
Characteristics at low temperature	V.DC	160	200	250	350	400	450	(Impedance ratio at 120 Hz)
	Z(-25 °C) / Z(+20 °C)	2	2	3	5	6	6	
Endurance	After the life test with DC rated working voltage at +105 °C±2 °C for 5000 hours, the capacitors shall meet the limits specified below. (Size code G13 : 3000 hours, G17 : 4000 hours)							
	Capacitance change	Within ±20 % of the initial value						
	tan δ	≤200 % of the initial limit						
	DC leakage current	Within the initial limit						
Shelf life	After storage for 1000 hours at +105 °C±2 °C with no voltage applied and then being stabilized at +20 °C, capacitors shall meet the limits specified in Endurance. (With voltage treatment)							
Resistance to soldering heat	After reflow soldering and then being stabilized at +20 °C, capacitors shall meet the following limits.							
	Capacitance change	Within ±10 % of the initial value						
	tan δ	Within the initial limit						
	DC leakage current	Within the initial limit						

Frequency correction factor for ripple current

Rated Voltage (V.DC)	Frequency (Hz)			
	120	1 k	10 k ≤ f < 30 k	30 k ≤ f ≤ 100 k
160 to 250	0.55	0.85	0.90	1.00
350 to 450	0.50	0.80	0.90	1.00

Marking

Example : 160 V.DC 10 μF
Marking color : BLACK

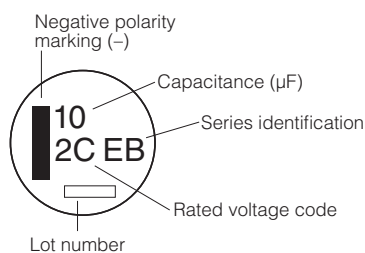

R. Voltage (V.DC)	160	200	250	350	400	450
Code	2C	2D	2E	2V	2G	2W

Dimensions

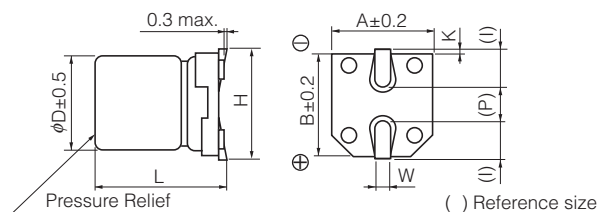

() Reference size
(Unit : mm)

Size code	φD	L	A,B	H	I	W	P	K
G13	10.0	13.5±0.5	10.3	12.0 max.	3.5	0.9±0.2	4.6	0.70±0.20
G17	10.0	16.5±0.5	10.3	12.0 max.	3.5	0.9±0.2	4.6	0.70±0.20
H16	12.5	16.5±0.5	13.5	15.0 max.	4.7	0.9±0.2	4.4	0.70±0.30
J16	16.0	16.5±0.5	17.0	19.0 max.	5.5	1.2±0.3	6.7	0.70±0.30
J21	16.0	21.5±0.5	17.0	19.0 max.	5.5	1.2±0.3	6.7	0.70±0.30
K16	18.0	16.5±0.5	19.0	21.0 max.	6.7	1.2±0.3	6.7	0.70±0.30
K21	18.0	21.5±0.5	19.0	21.0 max.	6.7	1.2±0.3	6.7	0.70±0.30

Characteristics list

Endurance : 105 °C 5000 h (G13 : 3000 h, G17 : 4000 h)

Rated voltage (V.DC)	Cap. (±20 %) (µF)	Case size (mm)		Size code	Specification			Part No.	Reflow	Min. Packaging Qty	
		φD	L		Ripple current (100 kHz) (+105 °C) (mA r.m.s.)	tan δ (120 Hz) (+20 °C)	Endurance (hours)			Taping	
160	10	10	13.5	G13	70	0.15	3000	EEVEB2C100Q	(4)	250	
	33	12.5	16.5	H16	470	0.15	5000	EEVEB2C330SQ	(4)	150	
	47	16	16.5	J16	600	0.15	5000	EEVEB2C470SM	(4)	125	
	68	16	21.5	J21	750	0.15	5000	EEVEB2C680M	(4)	75	
		18	16.5	K16	750	0.15	5000	EEVEB2C680SM	(4)	125	
	100	18	21.5	K21	1060	0.15	5000	EEVEB2C101M	(4)	75	
200	10	10	16.5	G17	80	0.15	4000	EEVEB2D100Q	(4)	200	
	22	12.5	16.5	H16	470	0.15	5000	EEVEB2D220SQ	(4)	150	
	33	16	16.5	J16	600	0.15	5000	EEVEB2D330SM	(4)	125	
	47	18	16.5	K16	600	0.15	5000	EEVEB2D470SM	(4)	125	
	68	16	21.5	J21	750	0.15	5000	EEVEB2D680M	(4)	75	
	100	18	21.5	K21	1060	0.15	5000	EEVEB2D101M	(4)	75	
250	10	10	16.5	G17	88	0.15	4000	EEVEB2E100Q	(4)	200	
	22	16	16.5	J16	560	0.15	5000	EEVEB2E220SM	(4)	125	
	33	18	16.5	K16	560	0.15	5000	EEVEB2E330SM	(4)	125	
	47	16	21.5	J21	710	0.15	5000	EEVEB2E470M	(4)	75	
	68	18	21.5	K21	990	0.15	5000	EEVEB2E680M	(4)	75	
350	3.3	10	13.5	G13	38	0.20	3000	EEVEB2V3R3Q	(4)	250	
	4.7	10	16.5	G17	50	0.20	4000	EEVEB2V4R7Q	(4)	200	
	10	16	16.5	J16	270	0.20	5000	EEVEB2V100SM	(4)	125	
	22	18	16.5	K16	350	0.20	5000	EEVEB2V220SM	(4)	125	
	33	16	21.5	J21	480	0.20	5000	EEVEB2V330M	(4)	75	
	47	18	21.5	K21	670	0.20	5000	EEVEB2V470M	(4)	75	
400	3.3	10	13.5	G13	40	0.24	3000	EEVEB2G3R3Q	(4)	250	
	4.7	10	16.5	G17	50	0.24	4000	EEVEB2G4R7Q	(4)	200	
	10	16	16.5	J16	250	0.24	5000	EEVEB2G100SM	(4)	125	
	22	16	21.5	J21	410	0.24	5000	EEVEB2G220M	(4)	75	
	33	18	21.5	K21	600	0.24	5000	EEVEB2G330M	(4)	75	
450	2.2	10	13.5	G13	29	0.24	3000	EEVEB2W2R2Q	(4)	250	
	3.3	10	16.5	G17	41	0.24	4000	EEVEB2W3R3Q	(4)	200	
	4.7	12.5	16.5	H16	49	0.24	5000	EEVEB2W4R7SQ	(4)	150	
	10	18	16.5	K16	310	0.24	5000	EEVEB2W100SM	(4)	125	
	22	18	21.5	K21	560	0.24	5000	EEVEB2W220M	(4)	75	

- Please refer to the page of "Reflow Profile" and "The Taping Dimensions".
- When requesting vibration-proof product, please put the last "V" instead to "Q or M"

CAUTION AND WARNING

1. The electronic components contained in this catalog are designed and produced for use in home electric appliances, office equipment, information equipment, communications equipment, and other general purpose electronic devices.
Before use of any of these components for equipment that requires a high degree of safety, such as medical instruments, aerospace equipment, disaster-prevention equipment, security equipment, vehicles (automobile, train, vessel), please be sure to contact our sales representative corporation.
2. When applying one of these components for equipment requiring a high degree of safety, no matter what sort of application it might be, be sure to install a protective circuit or redundancy arrangement to enhance the safety of your equipment. In addition, please carry out the safety test on your own responsibility.
3. When using our products, no matter what sort of equipment they might be used for, be sure to make a written agreement on the specifications with us in advance.
4. Technical information contained in this catalog is intended to convey examples of typical performances and or applications and is not intended to make any warranty with respect to the intellectual property rights or any other related rights of our company or any third parties nor grant any license under such rights.
5. In order to export products in this catalog, the exporter may be subject to the export license requirement under the Foreign Exchange and Foreign Trade Law of Japan.
6. No ozone-depleting substances (ODSs) under the Montreal Protocol are used in the manufacturing processes of Automotive & Industrial Systems Company, Panasonic Corporation.

● Please contact _____

● Factory _____

Device Solutions Business Division
Automotive & Industrial Systems Company

Panasonic[®]

1006 Kadoma, Kadoma City, Osaka 571-8506,
JAPAN

The information in this catalog is valid as of August 2018.