



# SPECIFICATION

## Surface Acoustic Wave Filter

USER



USER PART No.

SEMCO PART No. **SFHG52AA002**

DOC. No. SMS-51-L-SFT FX-44

DATE Jan 14, 2014

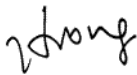
REVISION Preliminary

WISOL					
ISSUED BY	Kim, Kyung-Sik 	APPROVED BY (R&D)	Hong, Seong-Su 	APPROVED BY (QC)	Choi, Jae hyeong 
User					
ISSUED BY		CHECKED BY		APPROVED BY	

WISOL CO., LTD.  
531-7, Gajang-ro, Osan-si,  
Gyeonggi-do, KOREA, 447-210  
<http://www.wisol.co.kr>

▶ A TABLE OF CONTENTS

1. REVISION HISTORY .....	3
2. DEFINITION .....	4
3. PRECAUTIONS .....	4
4. OUTLINE DRAWING & DIMENSIONS .....	5
5. MARKING .....	6
6. PERFORMANCE .....	7
6-1. MAXIMUM RATINGS .....	7
6-2. ELECTRICAL CHARACTERISTICS .....	8
7. RELIABILITY .....	10
7-1. ENGINEERING SAMPLE FLOW CHART .....	10
7-2. TEST ITEM & CONDITION .....	11
8. REFLOW CONDITION .....	12
9. RECOMMENDED PCB DIMENSIONS .....	12
10. CAUTION .....	13
11. PACKING .....	14
11-1. DIMENSIONS .....	14
11-2. REELING QUANTITY .....	15
11-3. TAPING STRUCTURE .....	15
11-4. INNER BOX(Reel Packing) STRUCTURE .....	16
11-5. OUTER BOX STRUCTURE .....	17
12. TAPE SPECIFICATIONS .....	18
13. RoHS DATA .....	19

## 1. REVISION HISTORY

Preliminary	Jan 14, 2014	All Page	Make specification
-------------	--------------	----------	--------------------

## 2. DEFINITION

2-1. PART No.

**S F H G 5 2 A A 0 0 2**

①      ②      ③      ④      ⑤      ⑥

No.	EXPLANATION
①	SAW Filter
②	Design Type
③	Center Frequency :2350.0MHz(2300 ~ 2400)
④	Input:50ohm,Output:50ohm
⑤	Package size: 1.1×0.9mm <sup>2</sup>
⑥	Design Revision (02 : Molding Type)

2-2. APPLICATION : Band-Pass Filter for LTE Band40 Rx etc

## 3. PRECAUTIONS

3-1. This device should not be used in any type of fluid such as water, oil, organic solvent, etc.

3-2. This is a hermetic device.

MSL(Moisture Sensitive Level) is the '2a' level.

3-3. Ultrasonic cleaning shall be avoided.

3-4. Isopropyl Alcohol and Ethyl Alcohol can be used for cleaning. Contact us before using other cleaning solvents than above

3-5. This is an electrostatic sensitive device.

Please avoid static voltage during operation and storage.

3-6. Sudden change of temperature shall be avoided, deterioration of the characteristics can occur.

3-7. If any malfunction due to designing or manufacturing which is out of specification occurs within one year after the products have been delivered, the maker should exchange the defective products.

4. OUTLINE DRAWING & DIMENSIONS

[Unit: mm]

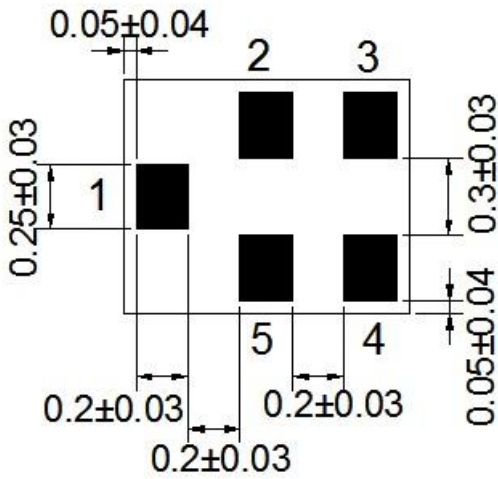
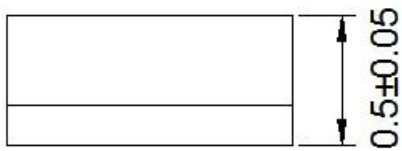
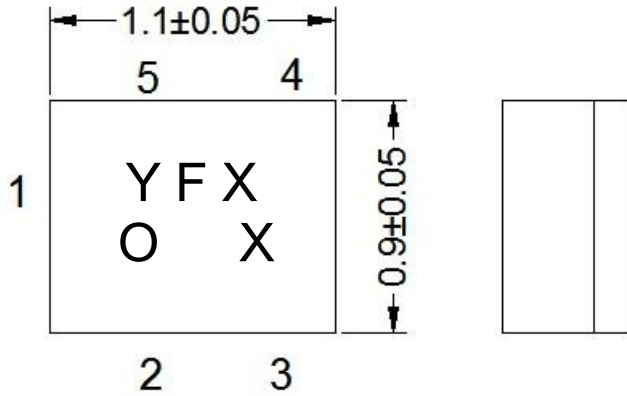

No.	Function
2, 3, 5	Ground
1	Unbalanced Input
4	Unbalanced Output

## 5. MARKING



### 5-1. Y F X X

- The 1<sup>st</sup> 2<sup>nd</sup> character 'YF' indicates the model name of SAW Filter SFHG52AA002.
- The 3<sup>rd</sup> character 'X' indicates the year and the month of manufacture.

Year	Month											
	1	2	3	4	5	6	7	8	9	10	11	12
2013	P	Q	R	S	T	U	V	W	X	Y	Z	a
2014	1	2	3	4	5	6	7	8	9	A	B	C
2015	D	E	F	G	H	I	J	K	L	M	N	O
2016	P	Q	R	S	T	U	V	W	X	Y	Z	a

※ This rotates by the 3 years.

- The 4<sup>th</sup> character 'X' indicates Lot No.

### 5-2. ○

- This symbol indicates input pin 1.
- This indicates the producing center
  - : China

### 5-3. Marking : Laser Marking

## 6. PERFORMANCE

### 6-1. MAXIMUM RATINGS

CHARACTERISTICS	RATINGS	UNITS
DC Permissive Voltage	5	V
Maximum Input Power	15	dBm
Operating Temperature Range	- 30 ~ +85	°C
Storage Temperature Range	- 40 ~ +85	°C

6-2. ELECTRICAL CHARACTERISTICS  
6-2-1. TABLE

Ta = - 30 ~ +85℃

Item	FREQUENCY RANGE [MHz]	UNIT	SPECIFICATION		
			Min.	Typ. (25℃)	Max.
Insertion Loss	2300 ~ 2400	dB	-	1.8	2.8
Inband Ripple	2300 ~ 2400	dB	-	0.7	1.8
Input VSWR	2300 ~ 2400	-	-	1.7	2.2
Output VSWR	2300 ~ 2400	-	-	1.5	2.2
Absolute Attenuation	0 ~ 1577	dB	24	29	-
	1577 ~1680	dB	23	28	-
	1845 ~ 1880	dB	21	26	-
	2110 ~2170	dB	21	26	-
	2460 ~ 2485	dB	20	33	-
	2485 ~ 2500	dB	29	35	-
	4600 ~ 4800	dB	30	39	-
	4800 ~ 6000	dB	28	36	-
Termination Impedance		Input: Unbalanced 50 ohm//9nH Output: Unbalanced 50 ohm//6nH			

6-2-2. TEST FIXTURE

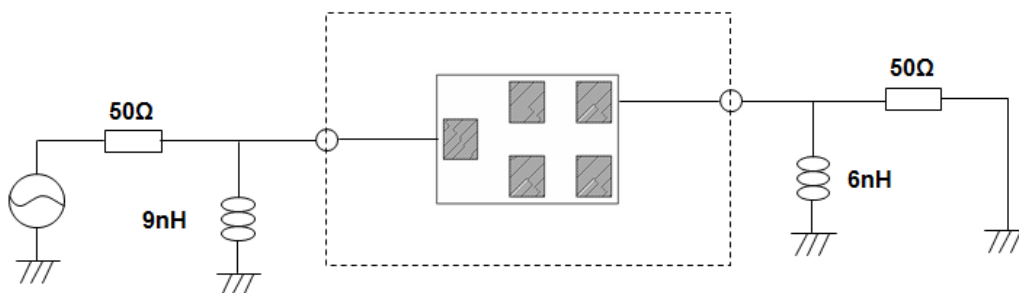

[X-Ray Top View]



6-2-3. GRAPH

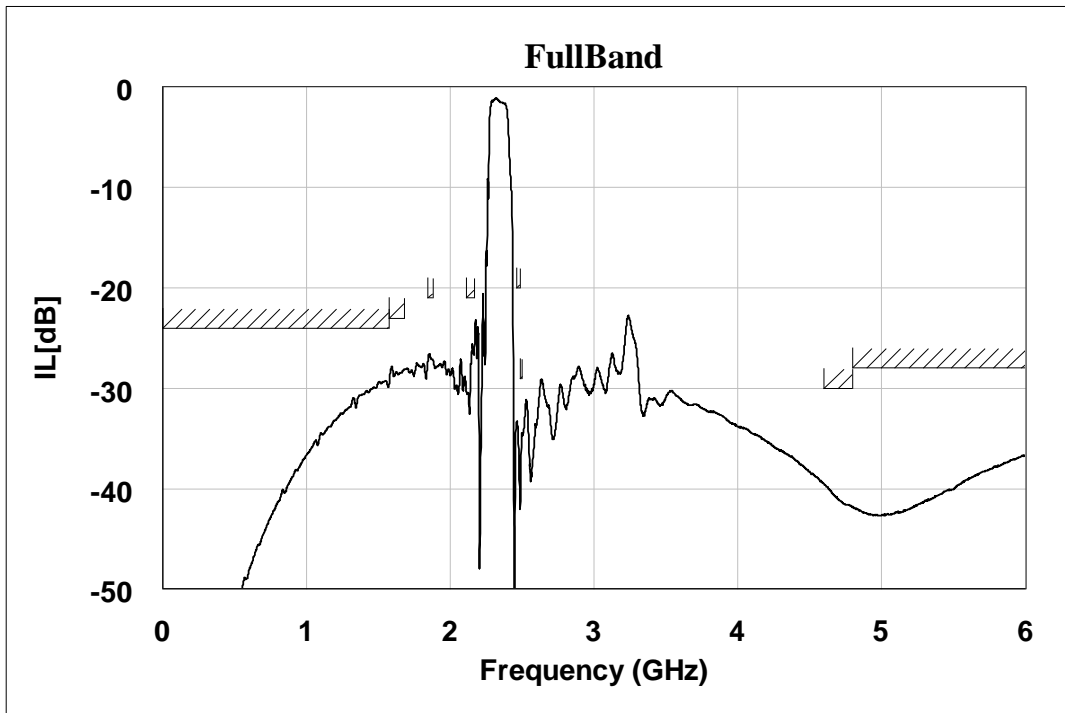
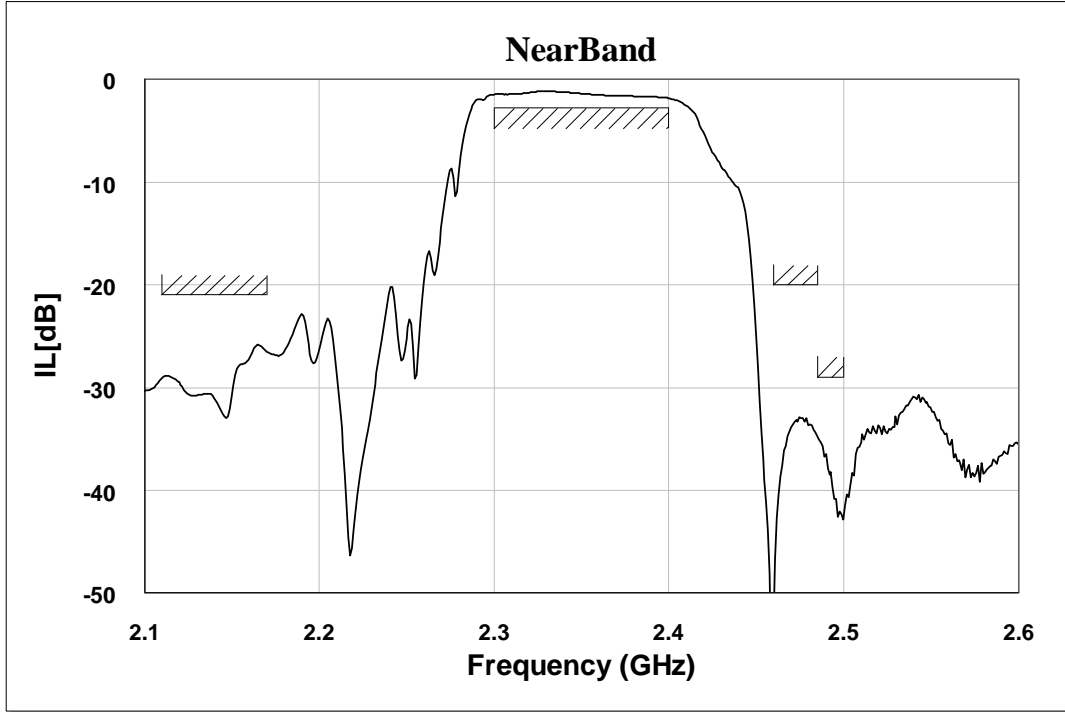

## 7. RELIABILITY

### 7-1. ENGINEERING SAMPLE FLOW CHART

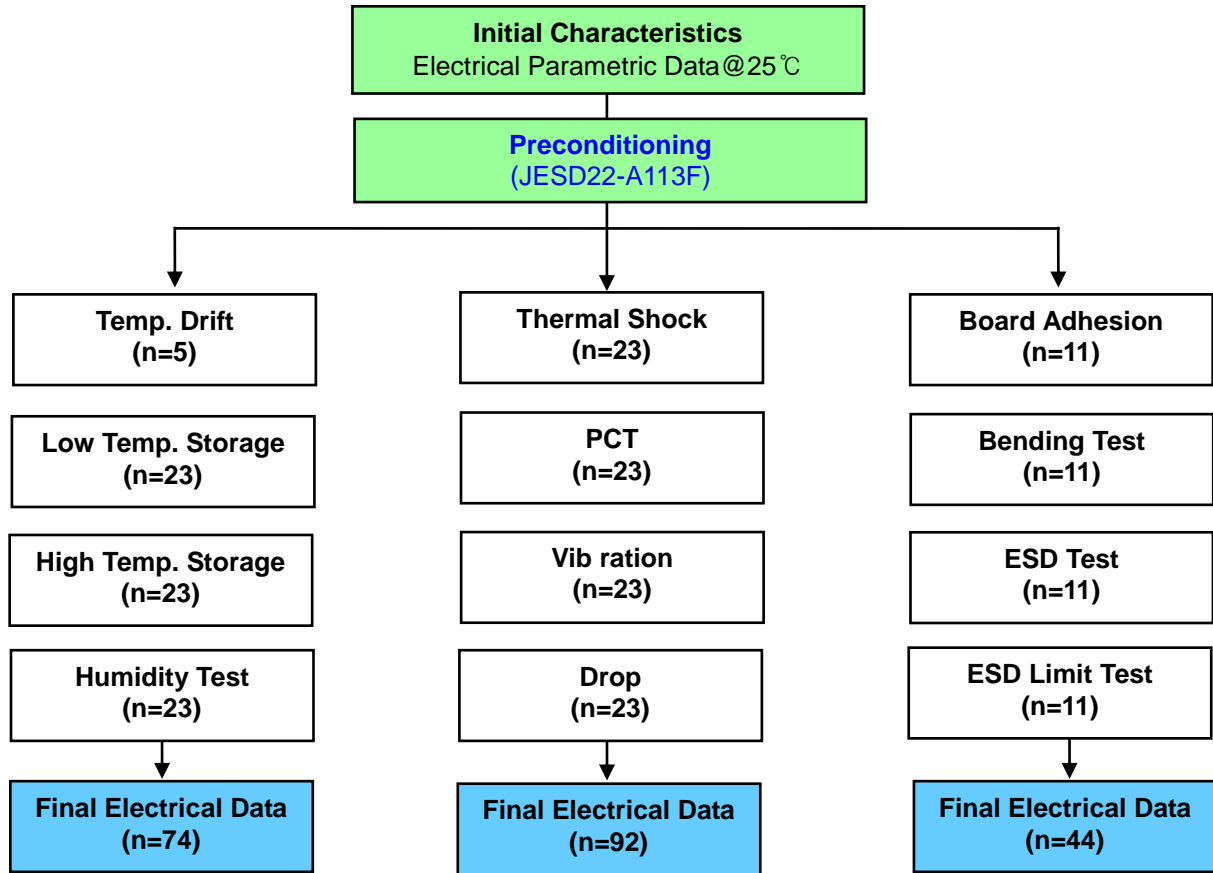

7-2. TEST ITEM & CONDITION

CATEGORY	TEST ITEM	TEST CONDITION	REMARK
	Preconditioning	+125℃ 24hr Baking → +60℃ 60%RH 120hr → Reflow Test(3times)	JESD22A113F



Environment Test	Temp. Drift	-30℃ → +25℃ → +85℃	description
	High Temp. Storage	+85℃ 240hr	JESD22-A103C
	Low Temp. Storage	-40℃ 240hr	JESD22-A119
	High Temp. High Humidity Storage	+85℃ 85%RH 240hr	JESD22-A106B
	Thermal Shock	-40℃/30min ⇔ +85℃/30min , 100cycle	JESD22-A106A
	High Temp. Operating	+121℃ 100%RH 96hr	JESD22-A102C
Mechanical Test	Vibration Test (Random)	20 Hz~2000 Hz,0.053G <sup>2</sup> /Hz or 8gs RMS,15min/plane	IEC 68-2-36 Fdb
	Drop Test	152 cm 12times Steel floor JIG(110g~150g)	IEC 1178-1.4.8.9
	Board Adhesion	0.5 mm/sec 1point push	IEC 68-2-21 Ue3
	Bending Test	0.5 mm/sec 3times -PCB : FR4 , PCB SIZE : 100*40 mm	IEC 68-2-21 Ue3
Physical Test	Solder Heat Resistance	±250V,C=100pF,R=1.5 kΩ, 1times	IEC 68-2-21 Ue3
	static marginal test	C=100pF,R=1.5 kΩ, 1times(demand of customer)	JESD22-A114F

### 8. REFLOW CONDITION

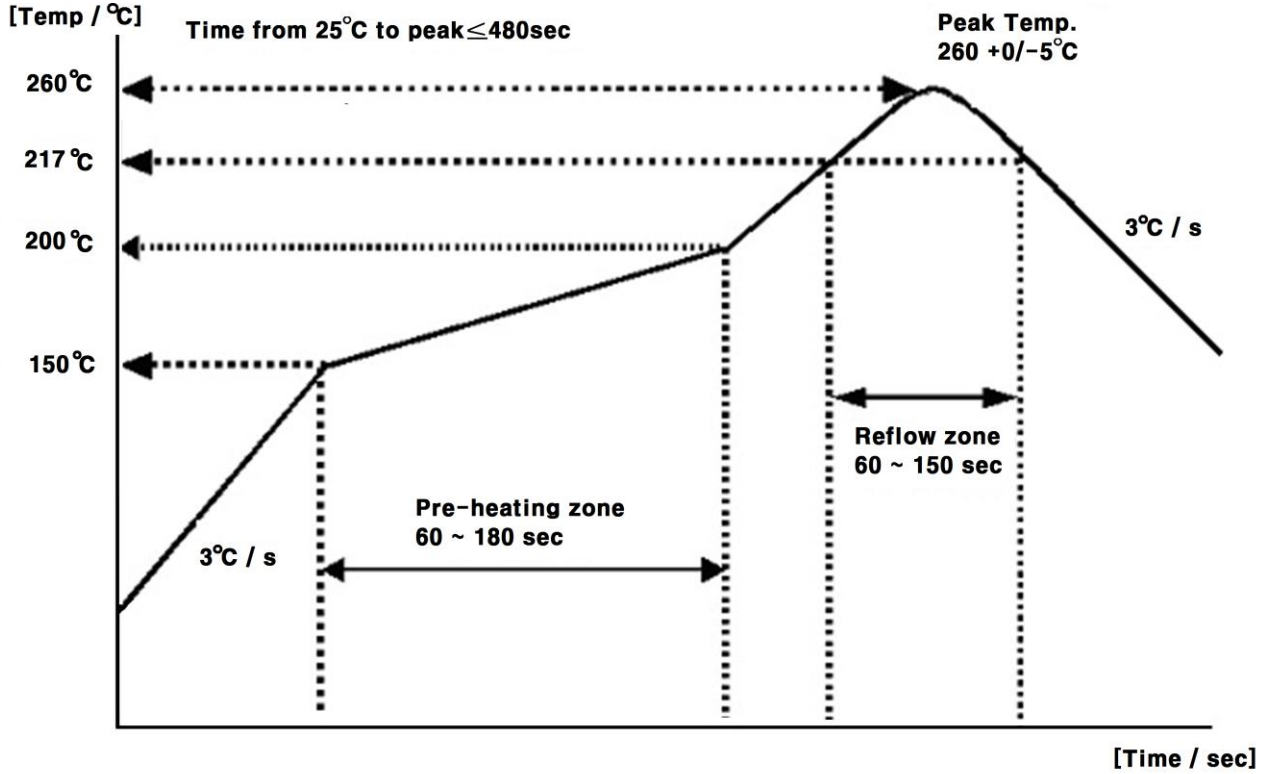

### 9. RECOMMENDED PCB DIMENSIONS

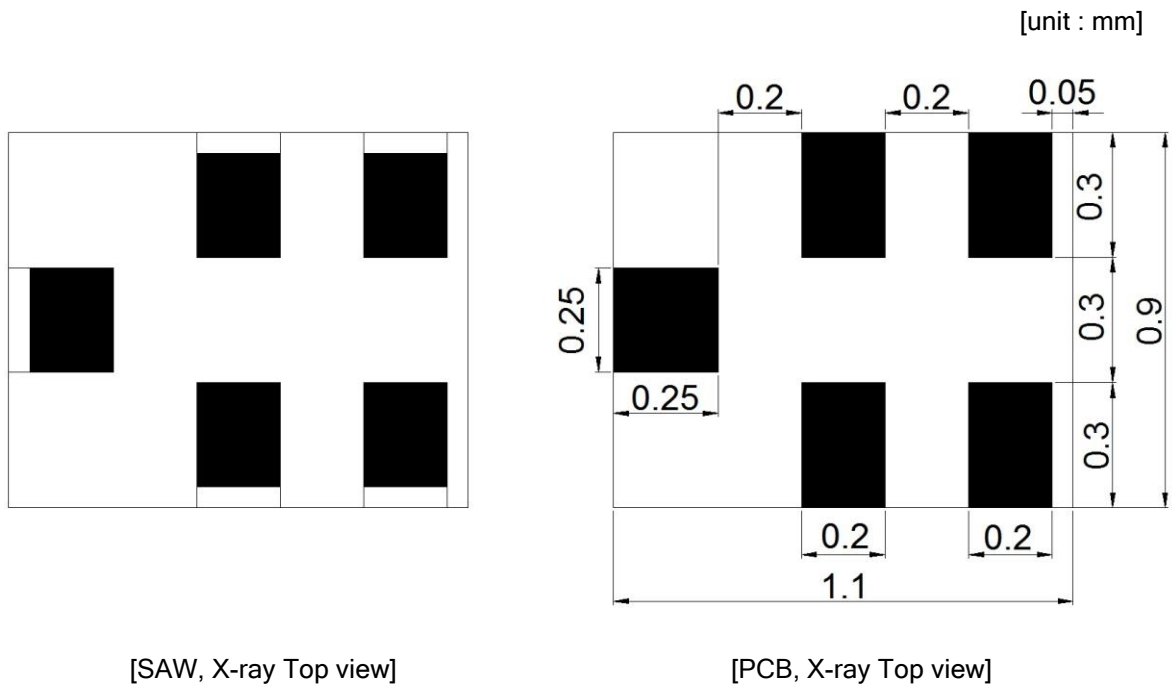

## 10. CAUTION

### Moisture Sensitivity Device Caution (MSL LEVEL=2a)

1. Calculated shelf life in sealed bag : 12 month at < 40°C and < 90% relative Humidity(RH)
  2. Peak package body temperature : **260°C**
  3. After bag is opened, devices that will be subjected to reflow solder or other high temperature process must be
    - (a) Mounted within : 672 hours of factory conditions ≤30°C/60% RH, or
    - (b) Stored per J-STD-033
  4. Device require bake, before mounting, if :
    - (a) Humidity Indicator Card reads > 60% when read at 23±5°C
    - (b) 3(a) or 3(b) are not met
  5. If baking is required, refer to IPC/JEDEC J-STD-033 for bake procedure
- Note : Level and body temperature defined by IPC/JEDEC J-STD-020

Aluminum Pack (310mmX370mm)



HIC(Humidity Indication Card)

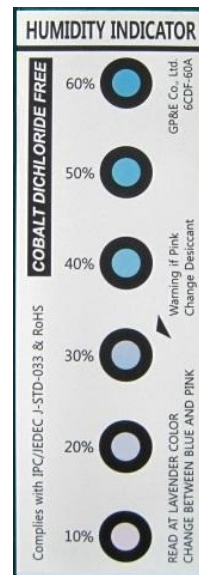

10 to 60% RH

### 11. PACKING

#### 11-1. DIMENSIONS

- Carrier Tape

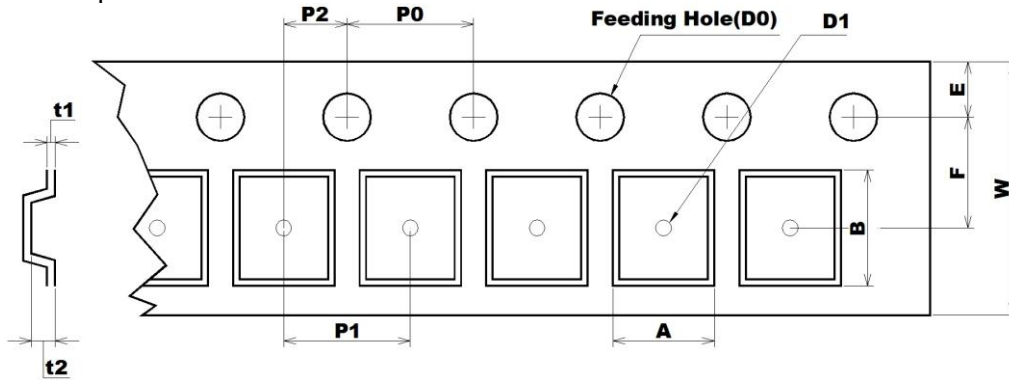

[Unit: mm]

A	B	D0	D1	E	F	P0	P1	P2	t1	t2	W
1.10	1.35	Ø1.50	Ø0.50	1.75	3.50	4.00	4.00	2.00	0.25	0.70	8.00
+0.05	+0.05	+0.10	+0.05	+0.10	+0.05	+0.10	+0.10	+0.05	+0.02	+0.05	+0.30
-0.05	-0.05	-0.00	-0.05	-0.10	-0.05	-0.10	-0.10	-0.05	-0.02	-0.05	-0.10

- Reel

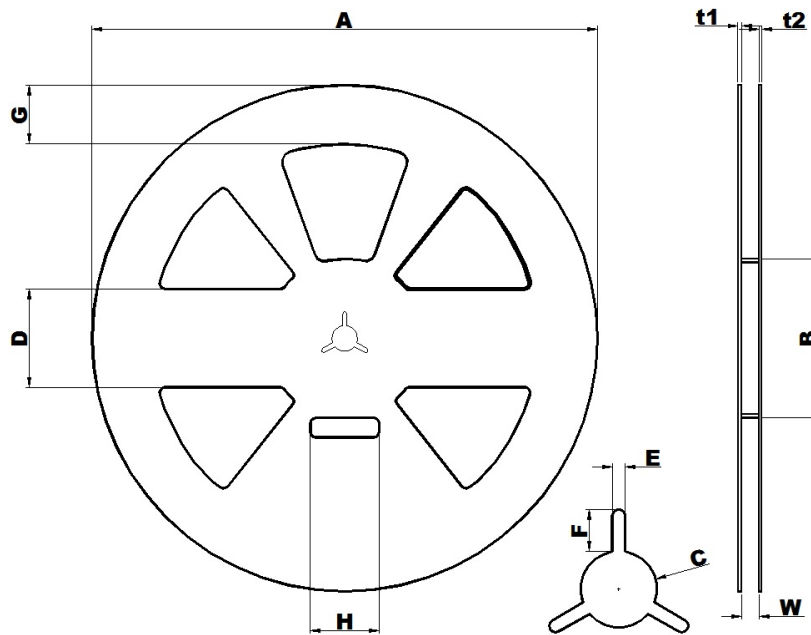

[Unit: mm]

A	B	C	D	E	F	G	H	t1	t2	W
Ø258.0	Ø81.0	Ø13.0	50.0	2.2	7.0	30.0	35.0	1.8	1.5	9.0
+1.0	+1.0	+0.5	+0.8	+0.3	+0.5	+0.8	+1.0	+0.5	+0.5	+1.0
-0.5	-1.0	-0.5	-0.8	-0.3	-0.5	-0.8	-1.0	-0.5	-0.5	-0.5

- The product shall be packed properly not to damaged during transportation and storage.

11-2. REELING QUANTITY

10 inch reel : 10,000 pcs/reel

11-3. TAPING STRUCTURE

11-3-1. The tape shall be wound around the reel in direction shown below.

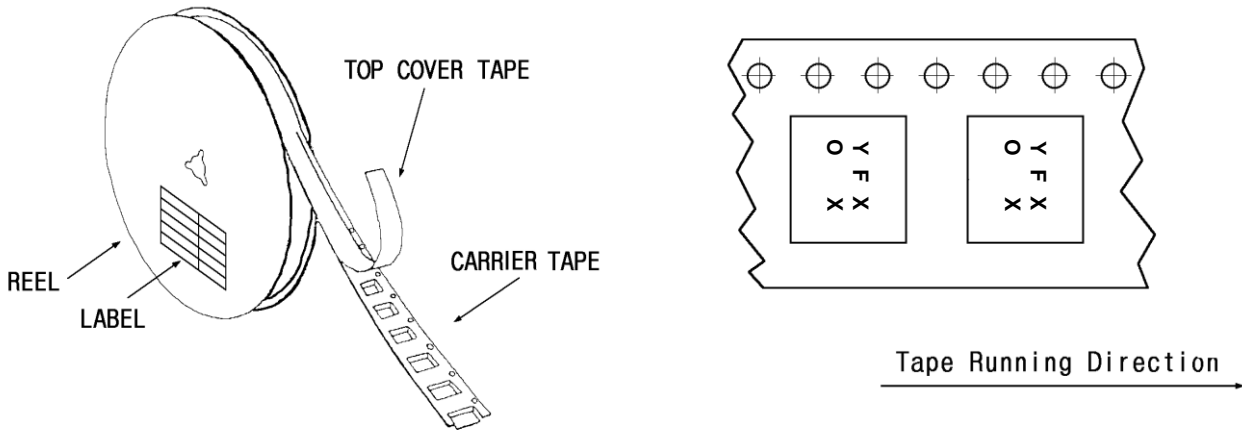

11-3-2. BAR CODE LABEL

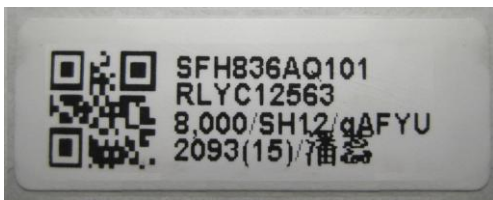

- |  |  |
|--|--|
| <ul style="list-style-type: none"> <li>① </li> <li>② SFH836AQ101</li> <li>③ RLYC12563</li> <li>④ 8,000 / qAFYU</li> </ul> | <p>MODEL NAME BARCODE</p> <p>Model Name</p> <p>Reel number</p> <p>Quantity / Marking</p> |
|--|--|

1-3-3. Leader part and vacant position specifications.

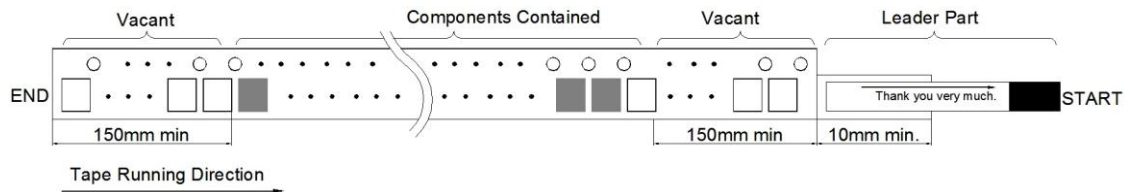

11-4. INNER BOX(Reel Packing) STRUCTURE

Material: Polycarbonate

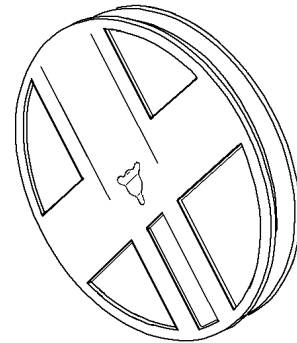

Material : Polyethylene + Aluminium  
Size : 310×370mm<sup>2</sup>

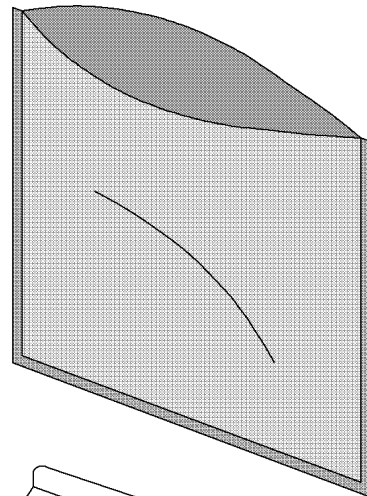

Material : Paper  
Size: (D)260×(W)37×(H)265mm<sup>3</sup>

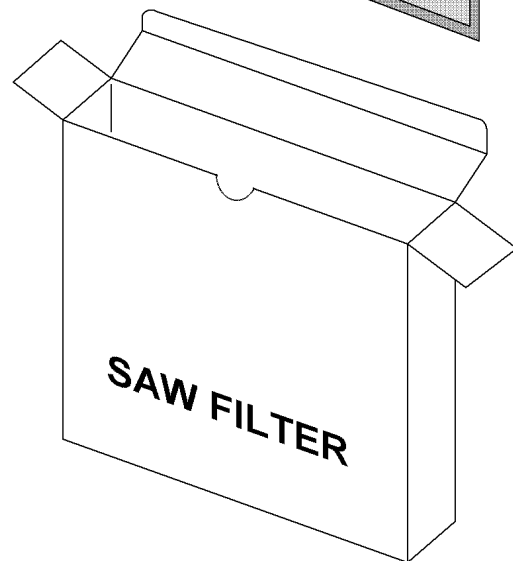



11-5. OUTER BOX STRUCTURE

Material : Paper

TYPE	SIZE(mm)			Inner Box #
	a	b	c	
A	270	240	275	6 boxes

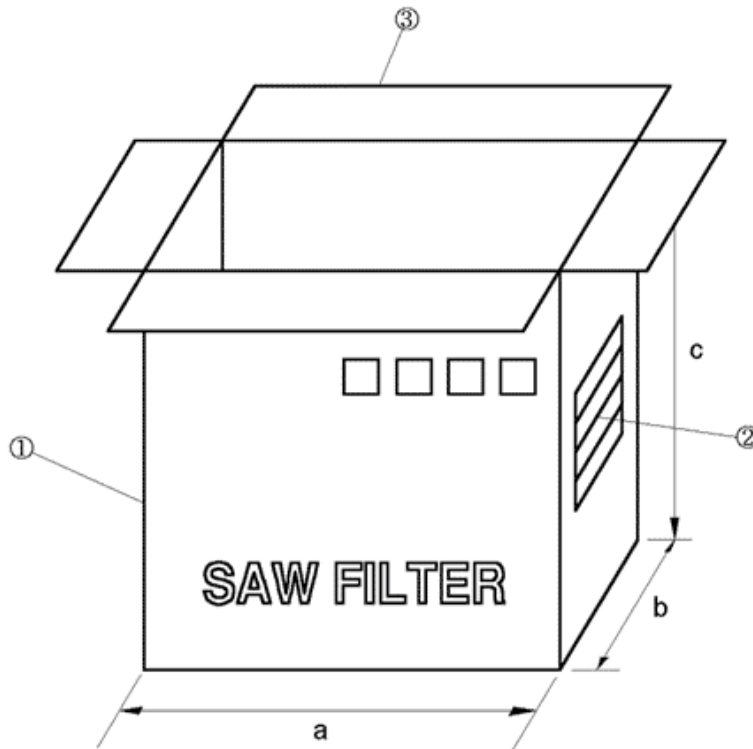

SIDE ①

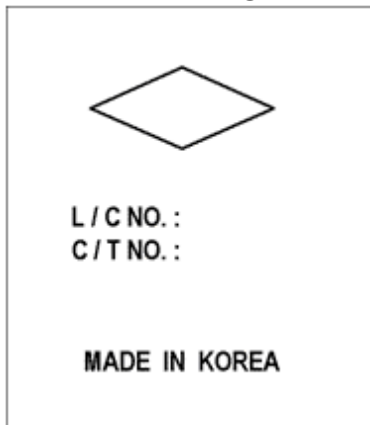

SIDE ②

MODEL	
Q'TY	EA
USER	
DATE	. . .

- SIDE is the same as front side.

## 12. TAPE SPECIFICATIONS

12-1. Tensile Strength of Carrier Tape: 4.4N/mm width

12-2. Top Cover Tape Adhesion (See the below figure)

- pull of angle: 0~15 degree
- speed: 300mm/min.
- force: 20~70g

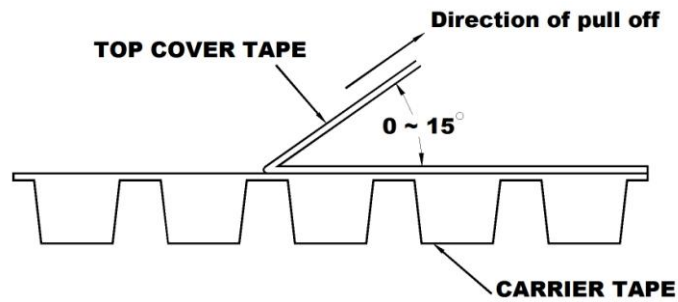

### 13. RoHS DATA



**Test Report No.** F690101/LF-CTSAYAA13-31939

Issued Date: 2013. 07. 08 Page 1 of 6

To: **WISOL CO., LTD.**  
 373-7  
 Gajang-dong  
 Osan-si  
 Gyeonggi-do  
 Korea

The following merchandise was submitted and identified by the client as :

<b>SGS File No.</b>	: AYAA13-31939
<b>Product Name</b>	: SAW FILTER
<b>Item No./Part No.</b>	: N/A
<b>Received Date</b>	: 2013. 07. 03
<b>Test Period</b>	: 2013. 07. 04 to 2013. 07. 08
<b>Buyer(s)</b>	: SAMSUNG
<b>Test Results</b>	: For further details, please refer to following page(s)
<b>Test Performed</b>	: SGS Korea tested the sample(s) selected by applicant with following results.
<b>Test Comments</b>	: By the applicant's specific request, the sampling and testing was performed only for the part indicated in the photo without disassembly.

Timothy Jeon  
 Jinhee Kim  
 Cindy Park  
 Jerry Jung/ Testing Person

SGS Korea Co., Ltd.  
  
 Jeff Jang / Chemical Lab Mgr

Document is issued by the Company subject to its General Conditions of Service which are available on request or accessible at <http://www.sgs.com/sgsweb/sgsweb.jsp> and for electronic format documents, subject to Terms and Conditions for Electronic Documents at <http://www.sgs.com/sgsweb/sgsweb.jsp>. Attention is drawn to the limitation of liability, indemnification and jurisdiction issues defined therein. Any issue of the document is subject that information contained herein reflects the Company's findings at the time of its intervention only and within the limits of Client's instructions. If the Company's tests (requirements) do not identify a defect, the document does not constitute evidence of a transaction free from existing or later rights and obligations under the transaction document. The document cannot be reproduced, stored in full, without prior written approval of the Company. Any unauthorized alteration, copy or distribution of the content or appearance of this document is prohibited and Offenders may be prosecuted to the fullest extent of the law. All references herein to the results shown in this test report refer only to the sample(s) tested and each sample(s) are retained for 30 days only.

SGS Korea Co., Ltd.

322, The O valley, 555-8, Hoge-dong, Dongan-gu, Anyang-si, Gyeonggi-do, Korea 431-080  
 t +82 (0)31 4808 000 f +82 (0)31 4808 059 <http://www.sgs.kor.com> [www.kr.sgs.com/greenlab](http://www.kr.sgs.com/greenlab)

D52 Version5

Member of the SGS Group (Société Générale de Surveillance)



**Test Report No.** F690101/LF-CTSAYAA13-31939

Issued Date: 2013. 07. 08 Page 2 of 8

**Sample No.** : AYAA13-31939.001  
**Sample Description** : SAW FILTER  
**Item No./Part No.** : N/A  
**Materials** : N/A

**Heavy Metals**

Test Items	Unit	Test Method	MDL	Results
Cadmium (Cd)	mg/kg	With reference to IEC 62321:2008, ICP	0.5	N.D.
Lead (Pb)	mg/kg	With reference to IEC 62321:2008, ICP	5	N.D.
Mercury (Hg)	mg/kg	With reference to IEC 62321:2008, ICP	2	N.D.
Hexavalent Chromium (Cr VI)	mg/kg	With reference to IEC 62321:2008, UV-VIS	1	N.D.
Antimony (Sb)	mg/kg	With reference to EPA 3052(1996), US EPA 6010B(1996), ICP	10	N.D.

**Flame Retardants-PBBs/PBDEs**

Test Items	Unit	Test Method	MDL	Results
Monobromobiphenyl	mg/kg	With reference to IEC 62321:2008, GC-MS	5	N.D.
Dibromobiphenyl	mg/kg	With reference to IEC 62321:2008, GC-MS	5	N.D.
Tribromobiphenyl	mg/kg	With reference to IEC 62321:2008, GC-MS	5	N.D.
Tetrabromobiphenyl	mg/kg	With reference to IEC 62321:2008, GC-MS	5	N.D.
Pentabromobiphenyl	mg/kg	With reference to IEC 62321:2008, GC-MS	5	N.D.
Hexabromobiphenyl	mg/kg	With reference to IEC 62321:2008, GC-MS	5	N.D.
Heptabromobiphenyl	mg/kg	With reference to IEC 62321:2008, GC-MS	5	N.D.
Octabromobiphenyl	mg/kg	With reference to IEC 62321:2008, GC-MS	5	N.D.
Nonabromobiphenyl	mg/kg	With reference to IEC 62321:2008, GC-MS	5	N.D.
Decabromobiphenyl	mg/kg	With reference to IEC 62321:2008, GC-MS	5	N.D.
Monobromodiphenyl ether	mg/kg	With reference to IEC 62321:2008, GC-MS	5	N.D.
Dibromodiphenyl ether	mg/kg	With reference to IEC 62321:2008, GC-MS	5	N.D.
Tribromodiphenyl ether	mg/kg	With reference to IEC 62321:2008, GC-MS	5	N.D.
Tetrabromodiphenyl ether	mg/kg	With reference to IEC 62321:2008, GC-MS	5	N.D.
Pentabromodiphenyl ether	mg/kg	With reference to IEC 62321:2008, GC-MS	5	N.D.
Hexabromodiphenyl ether	mg/kg	With reference to IEC 62321:2008, GC-MS	5	N.D.
Heptabromodiphenyl ether	mg/kg	With reference to IEC 62321:2008, GC-MS	5	N.D.
Octabromodiphenyl ether	mg/kg	With reference to IEC 62321:2008, GC-MS	5	N.D.
Nonabromodiphenyl ether	mg/kg	With reference to IEC 62321:2008, GC-MS	5	N.D.

**NOTE:**

- (1) N.D. = Not detected. (<MDL)
- (2) mg/kg = ppm
- (3) MDL = Method Detection Limit
- (4) - = No regulation
- (5) Negative = Undetectable / Positive = Detectable
- (6) \*\* = Qualitative analysis (No Unit)
- (7) \* = Boiling-water-extraction:  
 Negative = Absence of CrVI coating  
 Positive = Presence of CrVI coating; the detected concentration in boiling-water-extraction solution is equal or greater than 0.02 mg/kg with 50 cm<sup>2</sup> sample surface area.

The document is issued by the Company subject to its General Conditions of Service printed on request or available at [http://www.sgs.com/conditions\\_of\\_service.pdf](http://www.sgs.com/conditions_of_service.pdf), for electronic format documents, subject to Terms and Conditions for Electronic Documents at [http://www.sgs.com/conditions\\_of\\_service\\_electronic.pdf](http://www.sgs.com/conditions_of_service_electronic.pdf). Client's attention is drawn to the limitation of liability, indemnification and jurisdiction clause defined therein. Any holder of this document is advised that information contained herein reflects the Company's findings at the time of its intervention only and within the limits of Client's instructions, if any. The Company's sole responsibility is to its Client and this document does not constitute advice in a transaction from marketing of the rights and obligations under the transaction documents. This document cannot be reproduced, stored in a retrieval system or transmitted in any form or by any means, electronic, mechanical, photocopying, recording, or by any information storage and retrieval system, without prior written approval of the Company. Any unauthorized alteration, forgery or falsification of the content or appearance of this document is unlawful and offenders may be prosecuted to the fullest extent of the law. Client's attention is drawn to the results shown in this test report refer only to the samples tested and each sample(s) are related to 30 days only.



**Test Report No.** F690101/LF-CTSAYAA13-31939

Issued Date: 2013. 07. 08 Page 3 of 6

**Sample No.** : AYAA13-31939.001  
**Sample Description** : SAW FILTER  
**Item No./Part No.** : N/A  
**Materials** : N/A

**Flame Retardants-PBBs/PBDEs**

Test Items	Unit	Test Method	MDL	Results
Decabromodiphenyl ether	mg/kg	With reference to IEC 62321:2008, GC-MS	5	N.D.

**Halogen Content**

Test Items	Unit	Test Method	MDL	Results
Bromine(Br)	mg/kg	BS EN 14582:2007 , IC	30	N.D.
Chlorine(Cl)	mg/kg	BS EN 14582:2007 , IC	30	N.D.



**NOTE:**

- (1) N.D. = Not detected.(<MDL)
- (2) mg/kg = ppm
- (3) MDL = Method Detection Limit
- (4) - = No regulation
- (5) Negative = Undetectable / Positive = Detectable
- (6) \*\* = Qualitative analysis (No Unit)
- (7) \* = Boiling-water-extraction:  
 Negative = Absence of CrVI coating  
 Positive = Presence of CrVI coating; the detected concentration in boiling-water-extraction solution is equal or greater than 0.02 mg/kg with 50 cm2 sample surface area.

This document is issued by the Company subject to its General Conditions of Service which are available on request or available at <http://www.sgs.com/sgsweb/sgsweb.html>. In electronic format documents, subject to Terms and Conditions for Electronic Documents at <http://www.sgs.com/sgsweb/sgsweb.html>. Attention is drawn to the limitation of liability, indemnification and jurisdiction issues defined therein. Any holder of this document is advised that information contained herein reflects the Company's findings at the time of its intervention only and within the limits of Client's instructions. If the Company's work reasonably is to be Client and the document does not constitute advice in a jurisdiction from exercising of their rights and obligations under the applicable instruments. This document cannot be reproduced except in full, without prior written approval of the Company. Any unauthorized alteration, forgery or falsification of the content or appearance of this document is unlawful and offences may be prosecuted to the fullest extent of the law. Unless otherwise stated the results shown in this test report refer only to the sample(s) tested and each sample(s) are retained for 30 days only.



Test Report No. F690101/LF-CTSAYAA13-31939

Issued Date: 2013. 07. 08 Page 4 of 6

Testing Flow Chart for RoHS: Cd/Pb/Hg/Cr<sup>6+</sup> /PBBs&PBDEs Testing

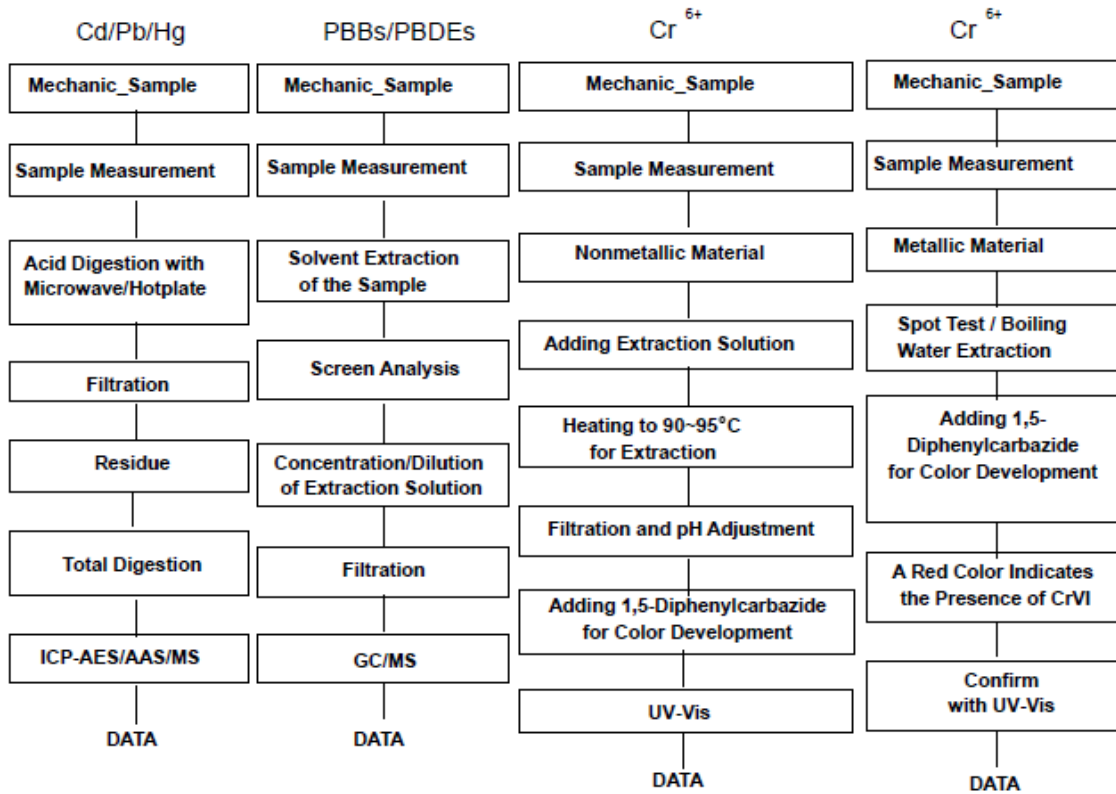

The samples were dissolved totally by pre-conditioning method according to above flow chart for Cd,Pb,Hg.  
Section Chief : Gilsae Yi

NOTE:

- (1) N.D. = Not detected. (<MDL)
- (2) mg/kg = ppm
- (3) MDL = Method Detection Limit
- (4) - = No regulation
- (5) Negative = Undetectable / Positive = Detectable
- (6) \*\* = Qualitative analysis (No Unit)
- (7) \* = Boiling-water-extraction:  
 Negative = Absence of CrVI coating  
 Positive = Presence of CrVI coating; the detected concentration in boiling-water-extraction solution is equal or greater than 0.02 mg/kg with 50 cm<sup>2</sup> sample surface area.

The document is issued by the Company subject to the General Conditions of Service printed hereafter, available on request or accessible at <http://www.sgs.com/rohsandconflictminerals> and, for electronic format documents, subject to Terms and Conditions for Electronic Documents at <http://www.sgs.com/rohsandconflictminerals>. Attention is drawn to the limitation of liability, indemnification and jurisdiction issues defined therein. Any holder of the document is advised that information contained therein reflects the Company's findings at the time of its intervention only and within the limits of Client's instructions. If any. The Company's sole responsibility is to its Client and this document does not constitute parties to a transaction from assuming all their rights and obligations under the transaction documents. This document cannot be reproduced, stored in a retrieval system, or transmitted in any form or by any means, electronic, mechanical, photocopying, recording, or by any information storage and retrieval system, without prior written approval of the Company. Any unauthorized alteration, forgery or falsification of the content or appearance of this document is illegal and offensive may be prosecuted to the fullest extent of the law. (Dates otherwise stated the results shown in this test report only apply to the sample(s) tested and each sample(s) are related to 30 days only.)



Test Report No. F690101/LF-CTSAYAA13-31939

Issued Date: 2013. 07. 08 Page 5 of 6

Flow Chart for Inorganic Elements Testing

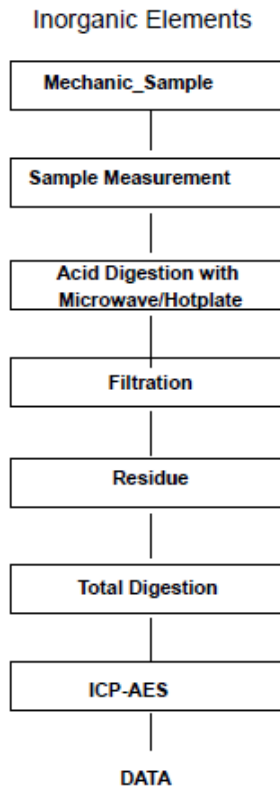

NOTE:

- (1) N.D. = Not detected.(<MDL)
- (2) mg/kg = ppm
- (3) MDL = Method Detection Limit
- (4) - = No regulation
- (5) Negative = Undetectable / Positive = Detectable
- (6) \*\* = Qualitative analysis (No Unit)
- (7) \* = Boiling-water-extraction:  
 Negative = Absence of CrVI coating  
 Positive = Presence of CrVI coating; the detected concentration in boiling-water-extraction solution is equal or greater than 0.02 mg/kg with 50 cm2 sample surface area.

\* Document is issued by the Company subject to the General Conditions of Service printed overleaf, available on request or accessible at [http://www.sgs.com/conditions\\_of\\_service.pdf](http://www.sgs.com/conditions_of_service.pdf), for analytical formal documents, subject to Terms and Conditions for Electronic Documents at [http://www.sgs.com/conditions\\_of\\_service\\_electronic\\_documents.pdf](http://www.sgs.com/conditions_of_service_electronic_documents.pdf). Information is given in the location of facility, identification and jurisdiction where defined therein. Any value of the document is entered and information contained therein reflects the Company's findings at the time of its issuance only and within the limits of Client's instructions. If the Company's sole responsibility is to be checked and the document does not accurately reflect a transaction from existing all their rights and obligations under the transaction documents. This document cannot be reproduced without the prior written approval of the Company. Any unauthorized alteration, any modification of the content or appearance of this document is prohibited and therefore may be prosecuted to the fullest extent of the law. All references stated the results shown in this test report refer only to the sample(s) tested and each sample(s) are related to 30 days only.

SGS Korea Co., Ltd.

322, The O valley, 555-8, Hoge-dong, Dongen-gu, Anyang-si, Gyeonggi-do, Korea 431-080  
 t +82 (0)31 4608 000 f +82 (0)31 4608 050 <http://www.sgslab.co.kr> [www.kr.sgs.com/greenlab](http://www.kr.sgs.com/greenlab)

\*052 Versions

Member of the SGS Group (Société Générale de Surveillance)



Test Report No. F690101/LF-CTSAYAA13-31939

Issued Date: 2013. 07. 08 Page 6 of 8

Flow Chart for Halogen Test

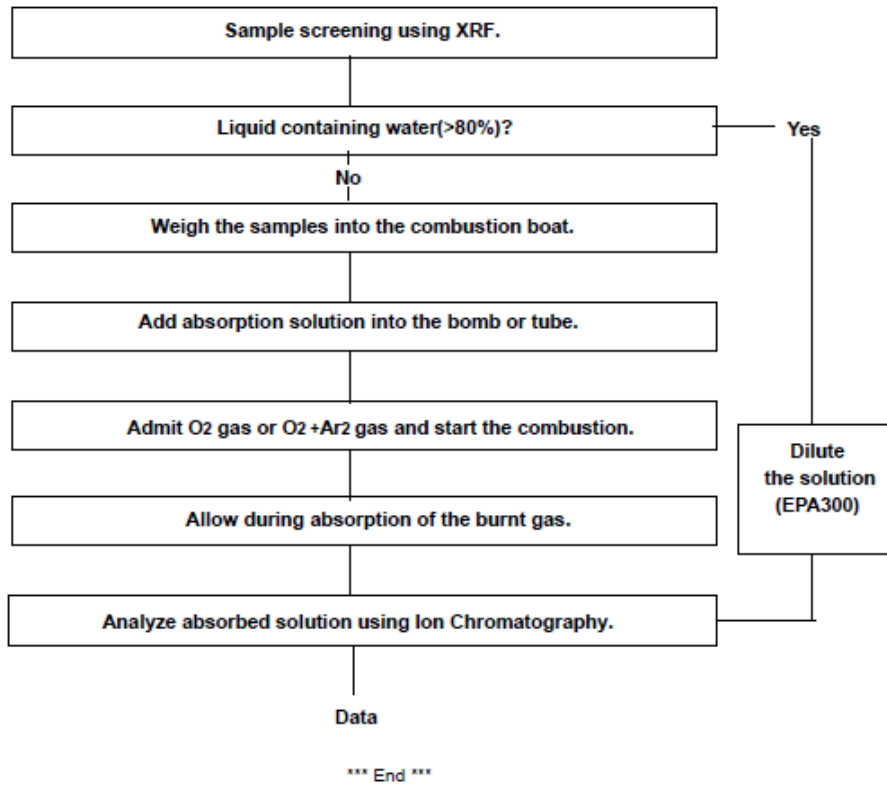

NOTE:

- (1) N.D. = Not detected.(<MDL)
- (2) mg/kg = ppm
- (3) MDL = Method Detection Limit
- (4) - = No regulation
- (5) Negative = Undetectable / Positive = Detectable
- (6) \*\* = Qualitative analysis (No Unit)
- (7) \* = Boiling-water-extraction:  
 Negative = Absence of CrVI coating  
 Positive = Presence of CrVI coating; the detected concentration in boiling-water-extraction solution is equal or greater than 0.02 mg/kg with 50 cm2 sample surface area.

This document is issued by the Company subject to its General Conditions of Service which are available on request or accessible at [http://www.sgs.com/ProductsandServices/sgs\\_en](http://www.sgs.com/ProductsandServices/sgs_en) for electronic format documents, subject to Terms and Conditions for Electronic Documents at [http://www.sgs.com/ProductsandServices/sgs\\_en](http://www.sgs.com/ProductsandServices/sgs_en), whenever it refers to the location of facility, identification and jurisdiction where defined therein. Any value of the document is subject to the information contained therein which is the Company's findings at the time of its issuance only and within the limits of Client's instructions. It is the Company's sole responsibility to its Client and this document does not constitute parties to a transaction from assuming all their rights and obligations under the transaction documents. This document cannot be reproduced except in full, without prior written approval of the Company. Any unauthorized alteration, copy or fabrication of the content or appearance of this document is unlawful and offenders may be prosecuted to the fullest extent of the law. Data observations upon the results shown in this test report are only for the associated test and each sample(s) are related to 30 days only.

F052 Version5

SGS Korea Co.,Ltd.

322, The O valley, 555-9, Hoggys-dong, Daejeon-gu, Anyang-si, Gyeonggi-do, Korea 431-080  
 t +82 (0)31 4608 000 f +82 (0)31 4608 050 <http://www.sgs.com/sgslab> [www.kr.sgs.com/sgslab](http://www.kr.sgs.com/sgslab)

Member of the SGS Group (Société Générale de Surveillance)