

Cautions and Warnings

Please be noted that this spec is only for reference if you have projects designed with the product number listed in. If you are looking for new project design-in, please find BBSY/BBBK Series specification/datasheet on Chilisin website. Or you may find our sales contact for more information on old part number at your convenience. Appreciated your attention and understanding.

Note: Please be sure to request approval specifications that provide further details of the products. Kindly note that the content of these specifications are subject to change or may be discontinued without prior notice. This product may not be designed/used in medical or high risk applications without Chilisin approval. Please contact our sales department before ordering.

Multilayer Ferrite Chip Beads



Chilisin offers a wide range of multi-layered ferrite chip beads with various sizes, frequency characteristics, and impedance values for EMI solutions. These ferrite formulas are used to compose seven types of EMI suppression chip beads: SB, GB, PB, UPB, NB, HF, and VPB series.

Product Identification

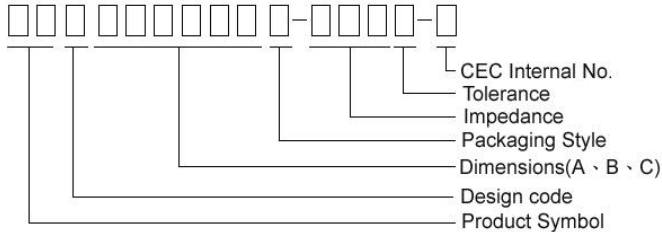

- Product symbol: SB, GB, PB, UPB, NB, HF, VPB
- Packaging: T : Tape and Reel ; B : Bulk
- Tolerance: Y = ± 25%; M = ± 20%; T:±30%
- Note: RoHS Compliant

Shape and Dimensions

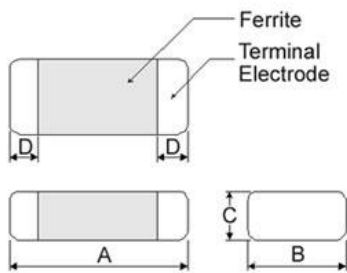

Recommended Pattern

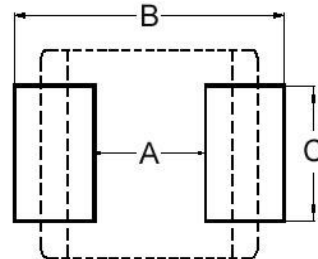

Dimensions in mm

TYPE	A	B	C	D
①060303	0.6±0.03	0.30±0.03	0.3±0.03	0.15±0.05
②100505	1.0±0.10	0.50±0.10	0.5±0.10	0.25±0.10
③160805	1.6±0.15	0.80±0.15	0.5±0.15	0.3±0.2
④160808	1.6±0.15	0.80±0.15	0.8±0.15	0.3±0.2
⑤201209	2.0±0.20	1.25±0.20	0.9±0.20	0.5±0.3
⑥321611	3.2±0.20	1.60±0.20	1.1±0.20	0.5±0.3

- ① : SBY / SBJ / NB / PB ② : SBY / SBJ / NB / PB / UPB / HF
 ③ : UPB ④ : SBK / SBJ / GB / PB / NB / UPB / VPB
 ⑤ : SBK / GB / PB / UPB ⑥ : SBY / SBK / PB / UPB

Dimensions in mm

TYPE	A	B	C
①060303	0.2 ~ 0.3	0.75 ~ 1.05	0.3
②100505	0.4	1.2 ~ 1.4	0.5
③160805	0.7 ~ 0.8	1.8 ~ 2.0	0.6 ~ 0.8
④160808	0.7 ~ 0.8	1.8 ~ 2.0	0.6 ~ 0.8
⑤201209	1.0 ~ 1.2	2.6 ~ 4.0	1.0 ~ 1.2
⑥321611	2.0	4.2 ~ 5.2	1.2

- * Don't apply narrower pattern than listed above to PB and UPB. Narrow pattern might cause excessive heat or open circuit.

Dimension Conversion

Code	Dimension in mm (AxBxC)	EIA
060303	0.6X0.3X0.3	0201
100505	1.0X0.5X0.5	0402
160805	1.6x0.8x0.5	0603
160808	1.6x0.8x0.8	0603
201209	2.0x1.2x0.9	0805
321611	3.2x1.6x1.1	1206

SMD Multilayer Ferrite Chip Beads – SBY/SBK Series

Electrical Characteristics

Part Number	Impedance ($\Omega \pm 25\%$)	Test Frequency (MHz)	RDC (Ω) Max	Rated current (mA) Max
SBY060303T-100Y-N	10	100	0.1	500
SBY060303T-600Y-N	60	100	0.4	200
SBY060303T-121Y-N	120	100	0.5	200
SBY060303T-241Y-N	240	100	0.8	200
SBY060303T-601Y-N	600	100	1.5	100

Note: When ordering, please specify tolerance code. Tolerance : Y= $\pm 25\%$

- Operating temperature range - 55°C ~ 125°C(Including self - temperature rise)
- Rate Current : Applied the current to coils, the temperature rise shall not be more than 30°C
- Measure Equipment :
Z : HP4291A
RDC : HP4338B or CHEN HWA 502

Test Instruments : Agilent E4991A Impedance / Material Analyzer

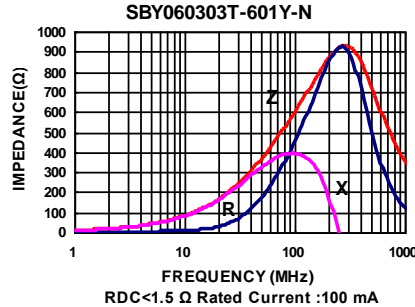
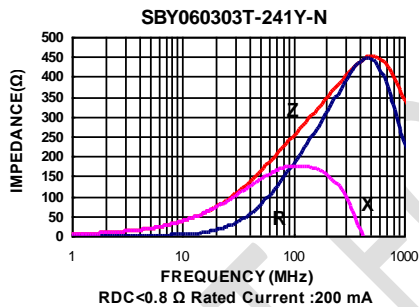
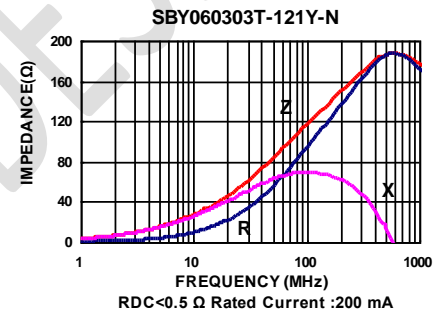
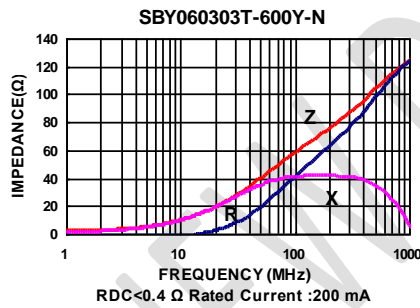
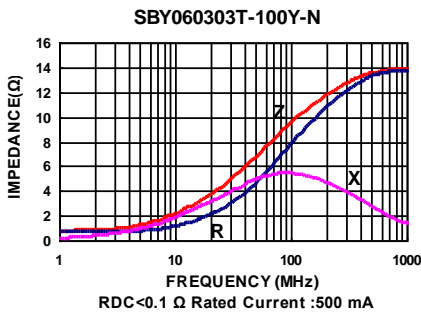

SMD Multilayer Ferrite Chip Beads – SBY/SBK Series

Electrical Characteristics

Part Number	Impedance ($\Omega \pm 25\%$)	Test Frequency (MHz)	RDC (Ω) Max	Rated current (mA) Max
SBY100505T-100Y-N	10	100	0.025	1000
SBY100505T-110Y-N	11	100	0.05	500
SBY100505T-150Y-N	15	100	0.10	500
SBY100505T-190Y-N	19	100	0.10	500
SBY100505T-220Y-N	22	100	0.15	500
SBY100505T-300Y-N	30	100	0.20	500
SBY100505T-320Y-N	32	100	0.20	500
SBY100505T-330Y-N	33	100	0.20	500
SBY100505T-400Y-N	40	100	0.20	500
SBY100505T-470Y-N	47	100	0.20	500
SBY100505T-500Y-N	50	100	0.20	500
SBY100505T-600Y-N	60	100	0.20	500
SBY100505T-700Y-N	70	100	0.15	600
SBY100505T-750Y-N	75	100	0.20	500
SBY100505T-800Y-N	80	100	0.20	500
SBY100505T-900Y-N	90	100	0.25	500
SBY100505T-101Y-N	100	100	0.25	500
SBY100505T-121Y-N	120	100	0.19	550
SBY100505T-151Y-N	150	100	0.40	400
SBY100505T-181Y-N	180	100	0.40	400
SBY100505T-221Y-N	220	100	0.29	450
SBY100505T-241Y-N	240	100	0.40	400
SBY100505T-301Y-N	300	100	0.50	300
SBY100505T-331Y-N	330	100	0.50	300
SBY100505T-471Y-N	470	100	0.50	300
SBY100505T-481Y-N	480	100	0.50	300
SBY100505T-601Y-N	600	100	0.52	300
SBY100505T-102Y-N	1000	100	0.65	300
SBY100505T-182Y-N	1800	100	1.40	100
SBY100505T-222Y-N	2200	100	1.40	100

Note: When ordering, please specify tolerance code. Tolerance : Y= $\pm 25\%$

- Operating temperature range - 55°C ~ 125°C(Including self - temperature rise)
- Rate Current : Applied the current to coils, the temperature rise shall not be more than 30°C
- Measure Equipment :
Z : HP4291A
RDC : HP4338B or CHEN HWA 502

Test Instruments : Agilent E4991A Impedance / Material Analyzer

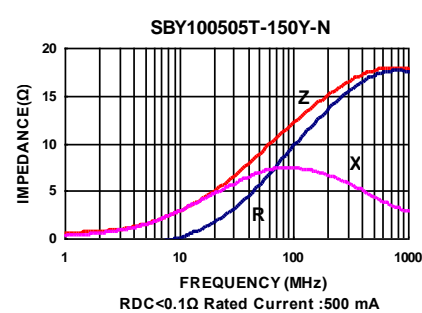
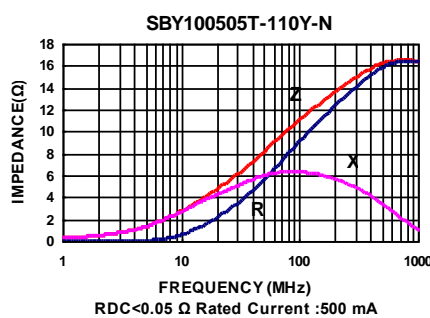
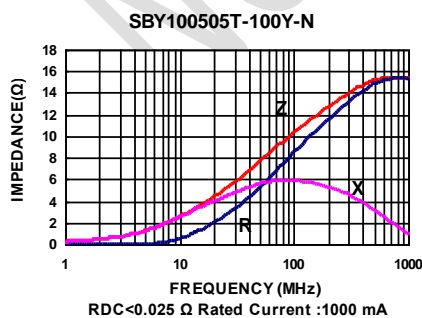

SMD Multilayer Ferrite Chip Beads – SBY/SBK Series

Test Instruments : Agilent E4991A Impedance / Material Analyzer

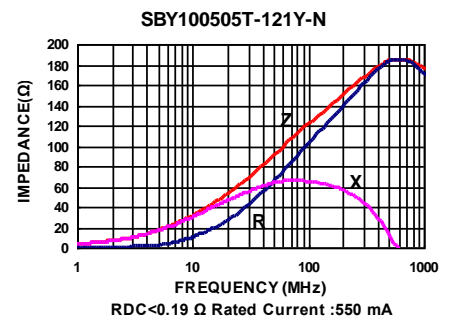
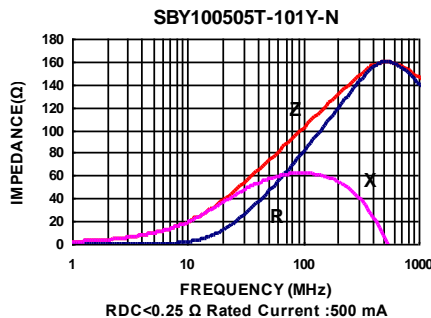
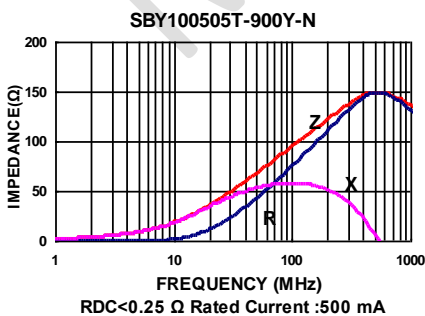
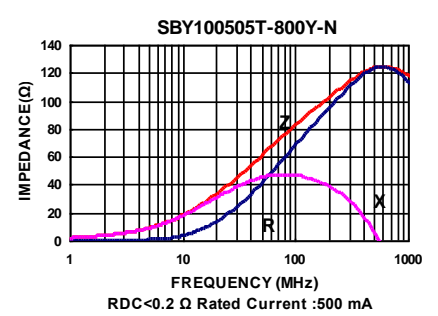
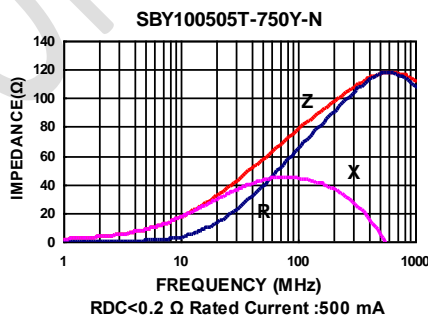
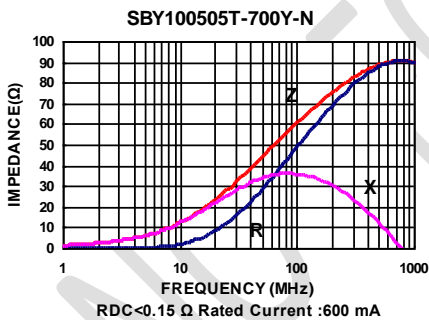
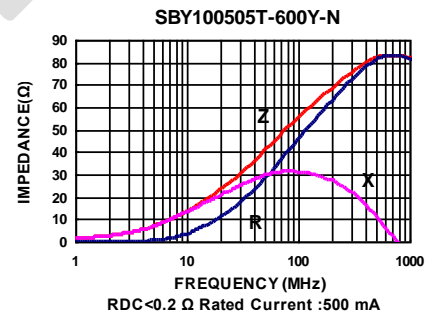
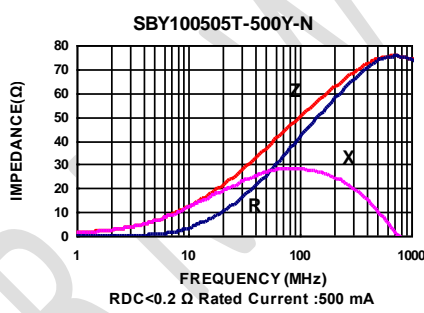
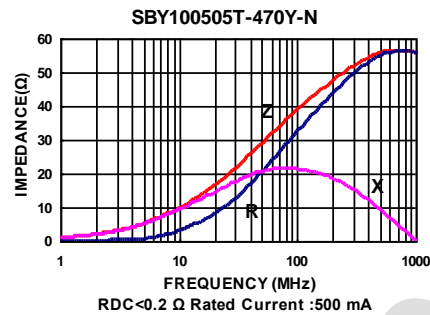
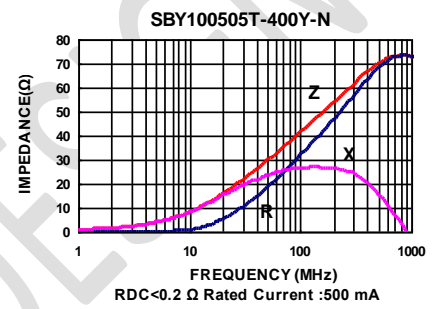
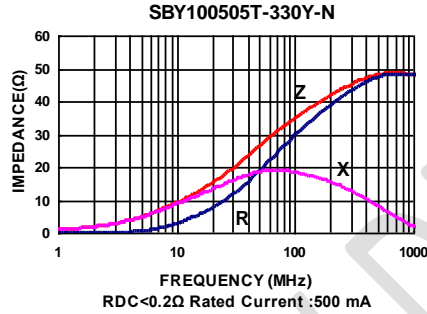
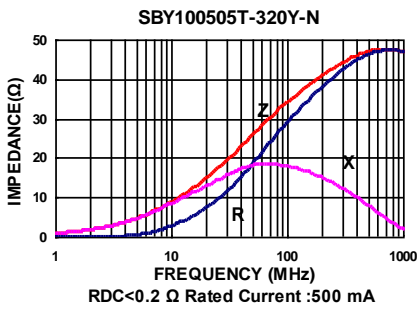
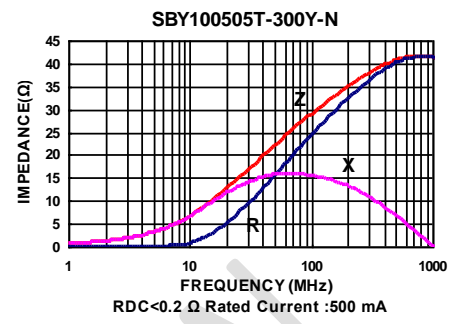
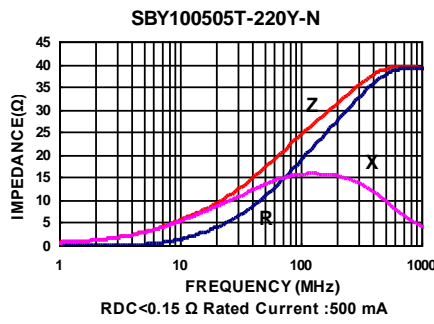
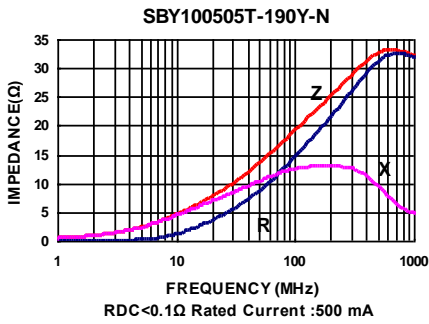

Please be sure to request approval specifications that provide further details of the products. Kindly note that the content of these specifications are subject to change or may be discontinued without prior notice. This product may not be designed/used in medical or high risk applications without Chilisin approval. Please contact our sales department before ordering.

SMD Multilayer Ferrite Chip Beads – SBY/SBK Series

Test Instruments : Agilent E4991A Impedance / Material Analyzer

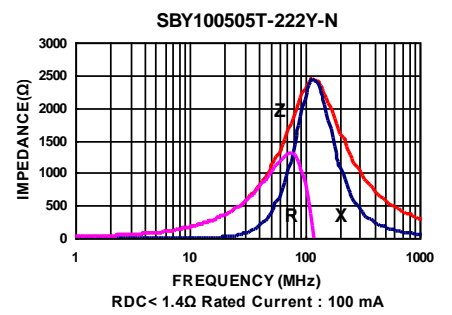
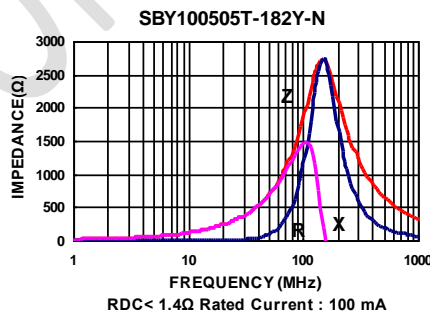
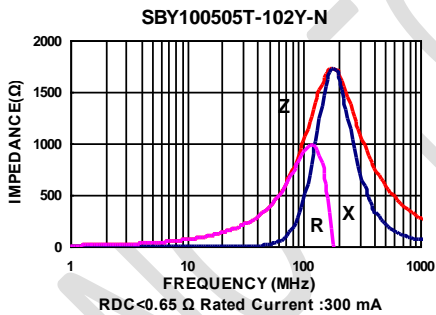
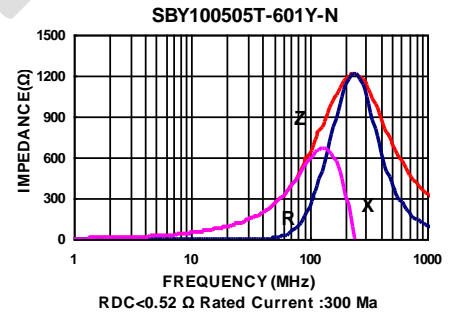
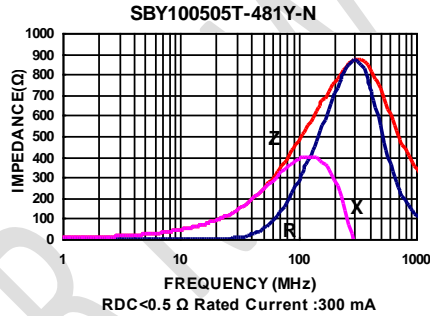
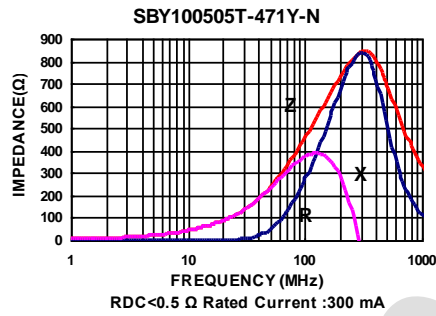
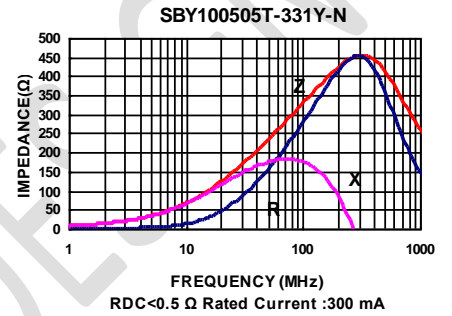
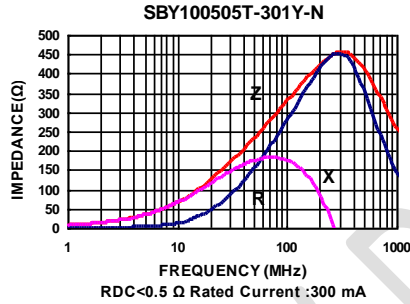
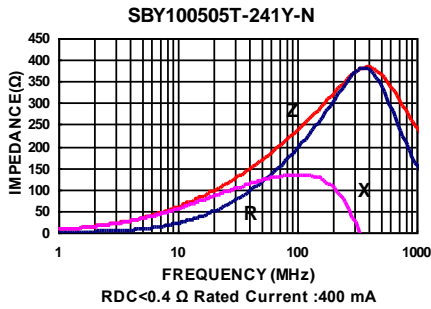
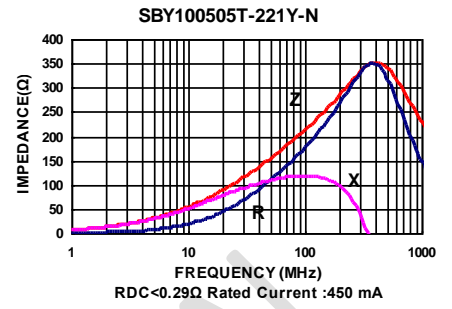
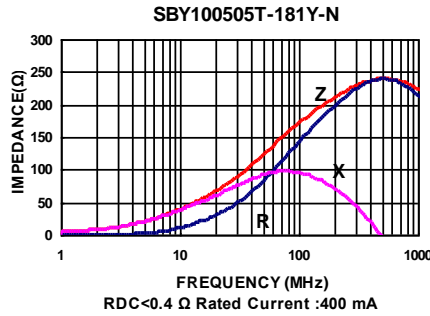
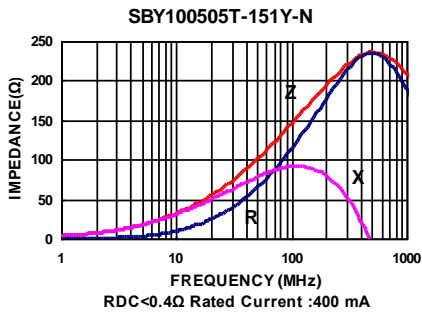

Please be sure to request approval specifications that provide further details of the products. Kindly note that the content of these specifications are subject to change or may be discontinued without prior notice. This product may not be designed/used in medical or high risk applications without Chilisin approval. Please contact our sales department before ordering.

SMD Multilayer Ferrite Chip Beads – SBY/SBK Series

Electrical Characteristics

Part Number	Impedance ($\Omega \pm 25\%$)	Test Frequency (MHz)	RDC (Ω) Max	Rated current (mA) Max
SBK160808T-100Y-N	10	100	0.05	500
SBK160808T-110Y-N	11	100	0.05	500
SBK160808T-300Y-N	30	100	0.10	400
SBK160808T-310Y-N	31	100	0.10	400
SBK160808T-600Y-N	60	100	0.10	400
SBK160808T-800Y-N	80	100	0.15	400
SBK160808T-121Y-N	120	100	0.25	400
SBK160808T-221Y-N	220	100	0.30	300
SBK160808T-301Y-N	300	100	0.40	300
SBK160808T-471Y-N	470	100	0.50	300
SBK160808T-601Y-N	600	100	0.50	300
SBK160808T-102Y-N	1000	100	0.60	300
SBK160808T-152Y-N	1500	100	0.60	300
SBK160808T-182Y-N	1800	100	0.80	200
SBK160808T-202Y-N	2000	100	0.80	200
SBK160808T-222Y-N	2200	100	0.80	200
SBK160808T-252Y-N	2500	100	0.80	200
SBK160808T-272Y-N	2700	100	0.80	200

Note: When ordering, please specify tolerance code. Tolerance : Y= $\pm 25\%$

- Operating temperature range - 55°C ~ 125°C(Including self - temperature rise)
- Rate Current : Applied the current to coils, the temperature rise shall not be more than 30°C
- Measure Equipment :
Z : HP4291A
RDC : HP4338B or CHEN HWA 502

Test Instruments : Agilent E4991A Impedance / Material Analyzer

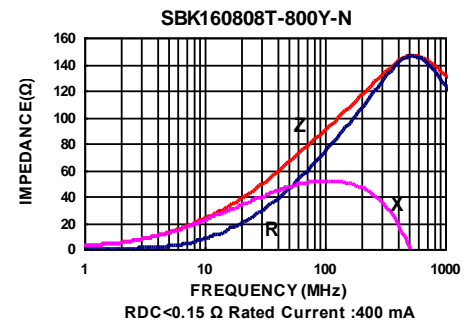
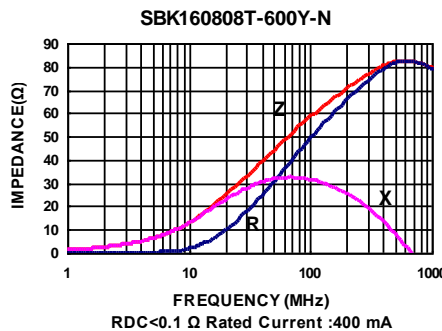
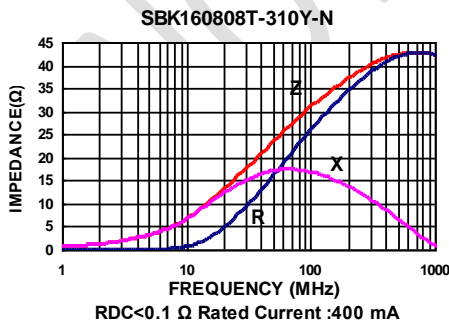
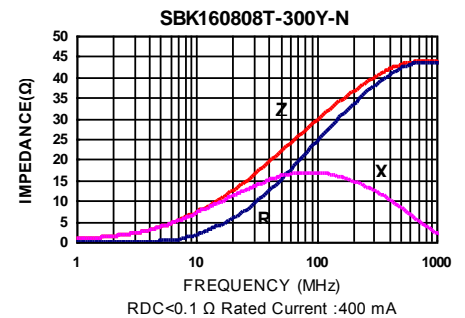
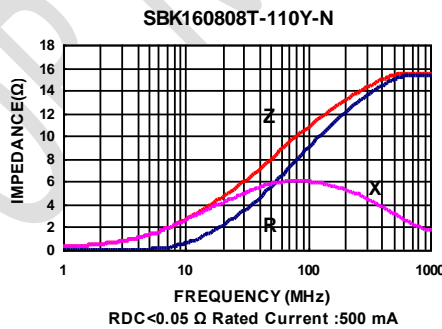
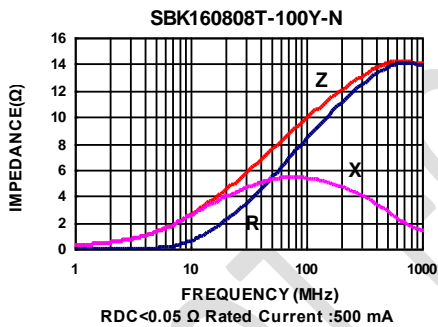

SMD Multilayer Ferrite Chip Beads – SBY/SBK Series

Test Instruments : Agilent E4991A Impedance / Material Analyzer

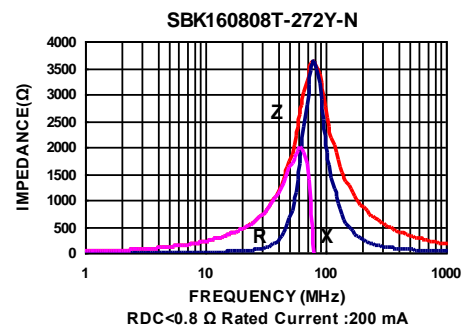
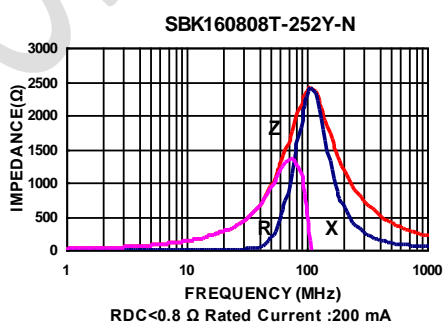
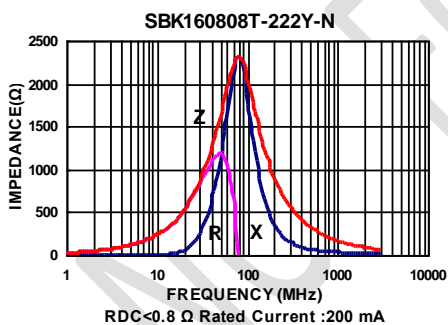
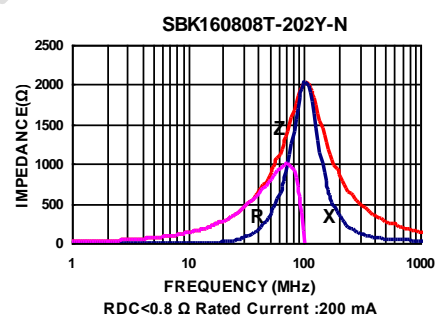
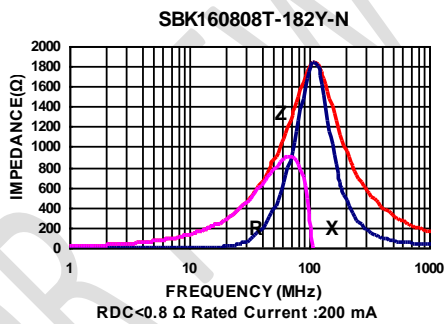
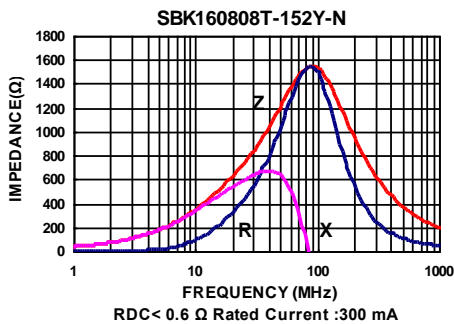
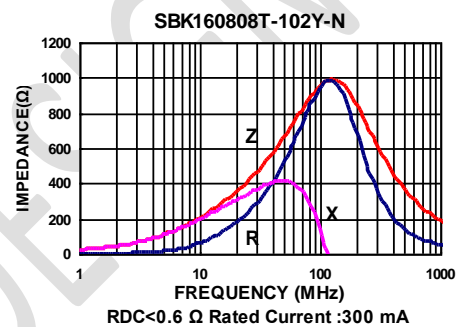
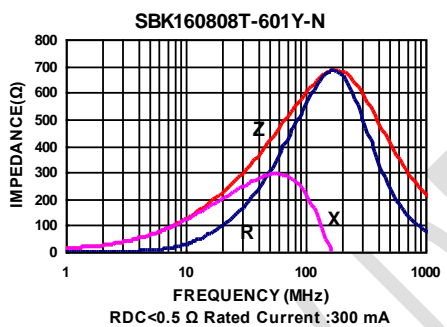
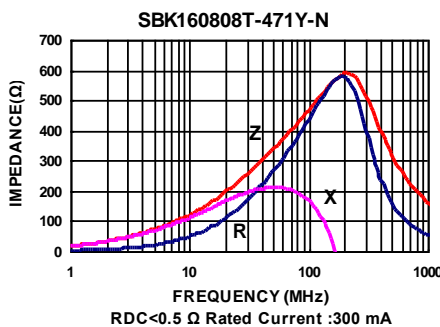
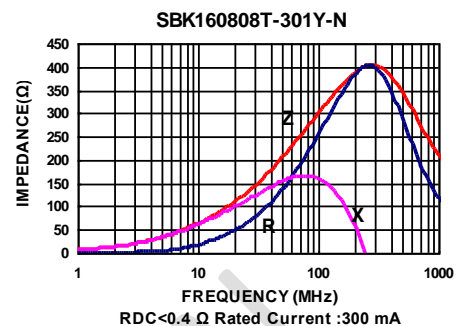
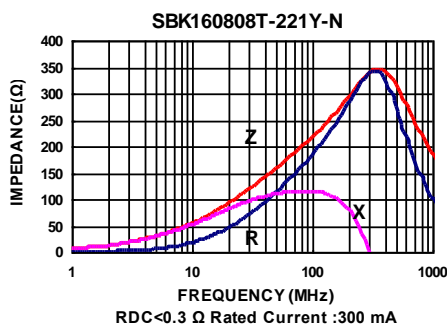
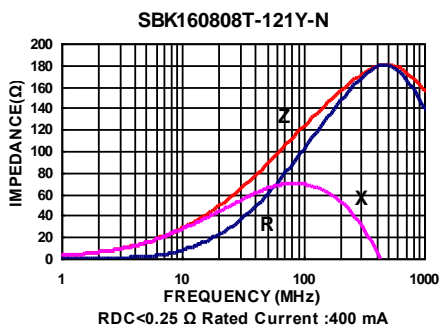

Please be sure to request approval specifications that provide further details of the products. Kindly note that the content of these specifications are subject to change or may be discontinued without prior notice. This product may not be designed/used in medical or high risk applications without Chilisin approval. Please contact our sales department before ordering.

SMD Multilayer Ferrite Chip Beads – SBY/SBK Series

Electrical Characteristics

Part Number	Impedance ($\Omega \pm 25\%$)	Test Frequency (MHz)	DC Resistance (Ω) Max	Rated current (mA) Max
SBK201209T-600Y-N	60	100	0.15	500
SBK201209T-800Y-N	80	100	0.15	500
SBK201209T-121Y-N	120	100	0.25	300
SBK201209T-221Y-N	220	100	0.30	300
SBK201209T-301Y-N	300	100	0.30	300
SBK201209T-431Y-N	430	100	0.40	300
SBK201209T-471Y-N	470	100	0.40	300
SBK201209T-601Y-N	600	100	0.40	300
SBK201209T-102Y-N	1000	100	0.50	200
SBK201209T-122Y-N	1200	100	0.60	200
SBK201209T-152Y-N	1500	100	0.60	200
SBK201209T-202Y-N	2000	100	0.70	200
SBK201209T-222Y-N	2200	100	0.70	200
SBK201209T-252Y-N	2500	100	0.70	200
SBK201209T-272Y-N	2700	100	0.70	200

Note: When ordering, please specify tolerance code. Tolerance : Y= $\pm 25\%$

- Operating temperature range - 55°C ~ 125°C(Including self - temperature rise)
- Rate Current : Applied the current to coils, the temperature rise shall not be more than 30°C
- Measure Equipment :
Z : HP4291A
RDC : HP4338B or CHEN HWA 502

Test Instruments : Agilent E4991A Impedance / Material Analyzer

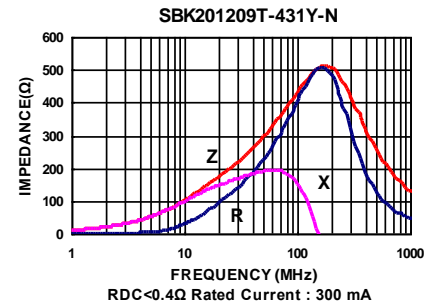
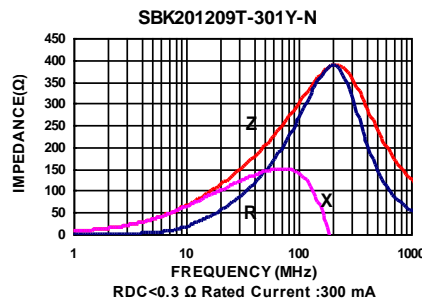
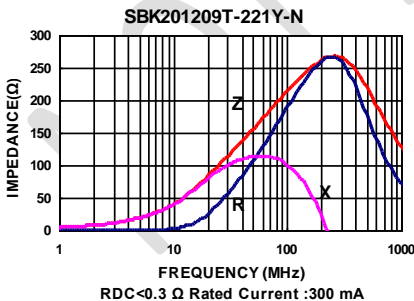
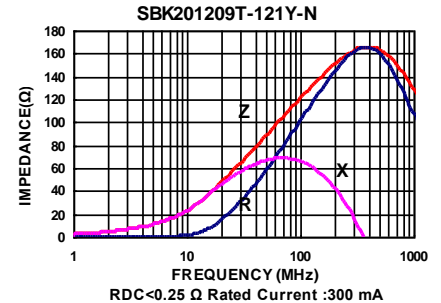
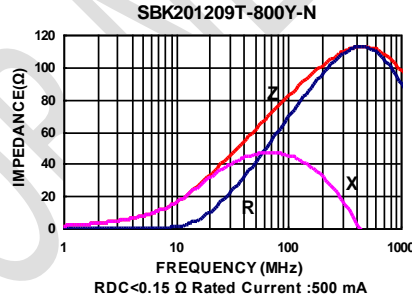
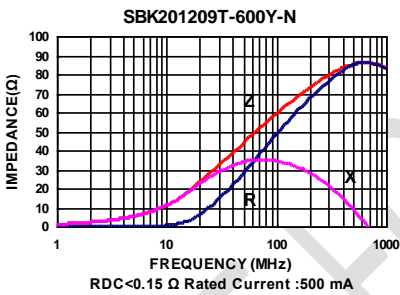

SMD Multilayer Ferrite Chip Beads – SBY/SBK Series

Test Instruments : Agilent E4991A Impedance / Material Analyzer

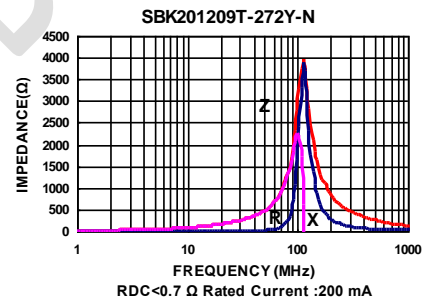
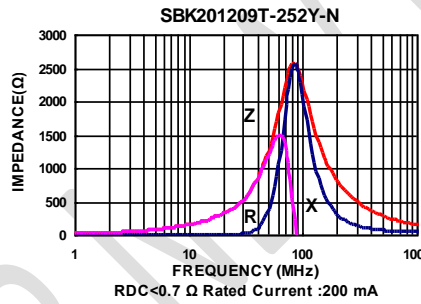
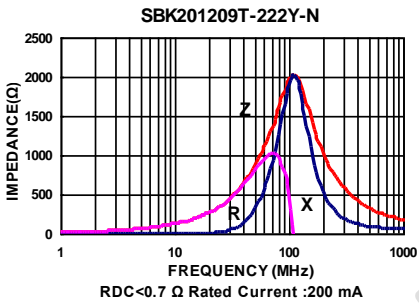
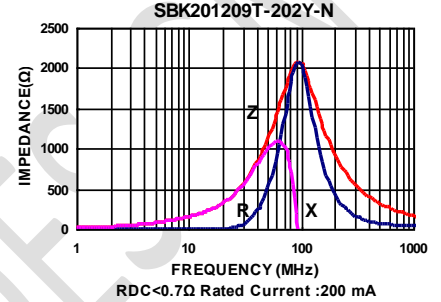
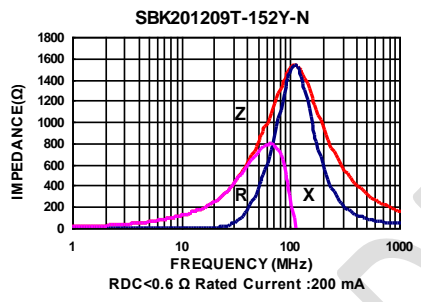
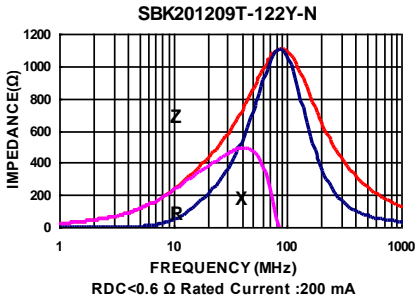
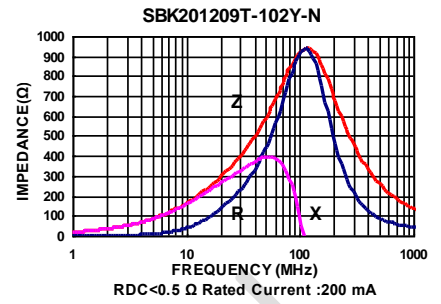
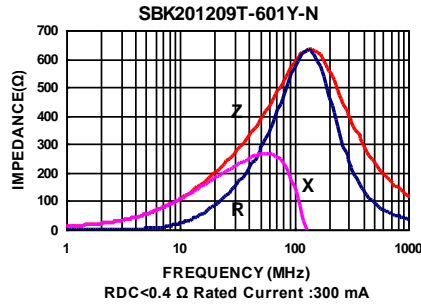
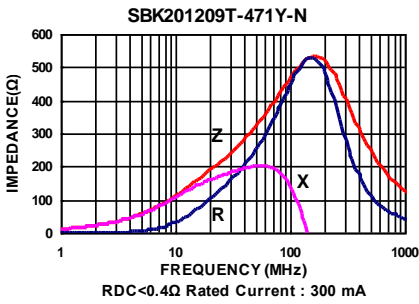

Please be sure to request approval specifications that provide further details of the products. Kindly note that the content of these specifications are subject to change or may be discontinued without prior notice. This product may not be designed/used in medical or high risk applications without Chilisin approval. Please contact our sales department before ordering.

SMD Multilayer Ferrite Chip Beads – SBY/SBK Series

Electrical Characteristics

Part Number	Impedance ($\Omega \pm 25\%$)	Test Frequency (MHz)	RDC (Ω) Max	Rated current (mA) Max
SBK321611T-900Y-N	90	100	0.15	500
SBK321611T-121Y-N	120	100	0.15	500
SBK321611T-471Y-N	470	100	0.20	400
SBK321611T-601Y-N	600	100	0.30	400
SBK321611T-102Y-N	1000	50	0.40	200
SBK321611T-122Y-N	1200	50	0.40	200
SBK321611T-152Y-N	1500	50	0.45	200

Note: When ordering, please specify tolerance code. Tolerance : $Y \pm 25\%$

- Operating temperature range - 55°C ~ 125°C(Including self - temperature rise)
- Rate Current : Applied the current to coils, the temperature rise shall not be more than 30°C
- Measure Equipment :
Z : HP4291A
RDC : HP4338B or CHEN HWA 502

Test Instruments : Agilent E4991A Impedance / Material Analyzer

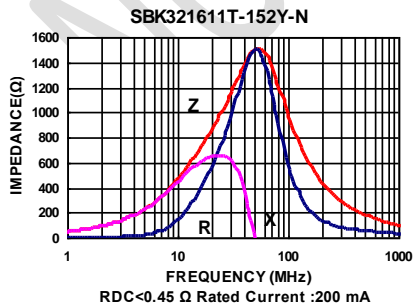
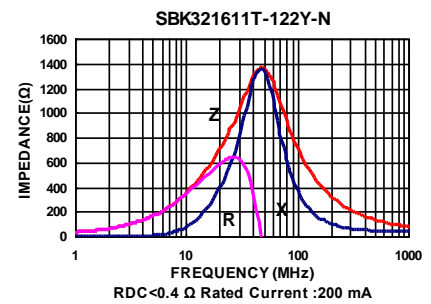
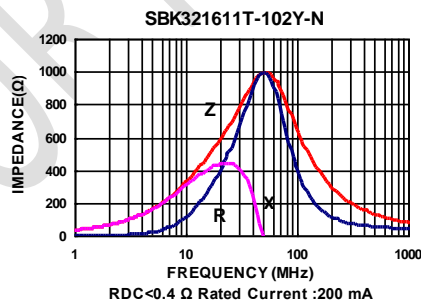
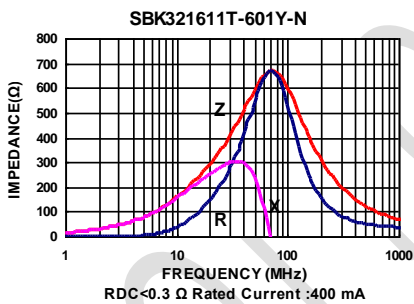
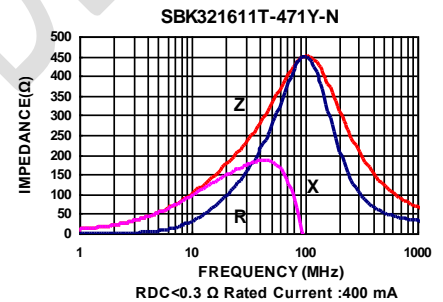
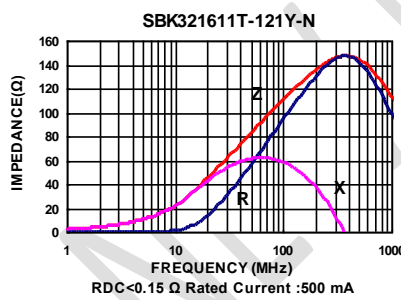
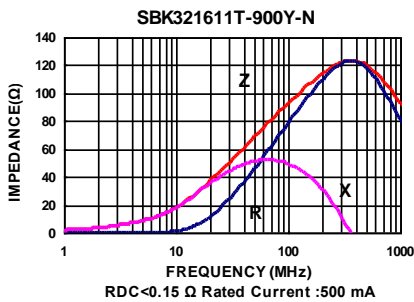

SMD Multilayer Chip Beads

Packaging Specifications

Tape Dimensions

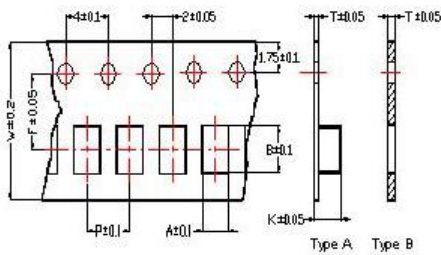

Tape Material

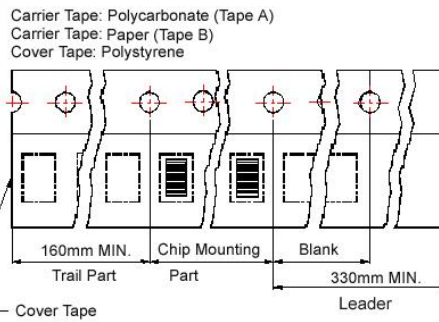

Reel Dimensions

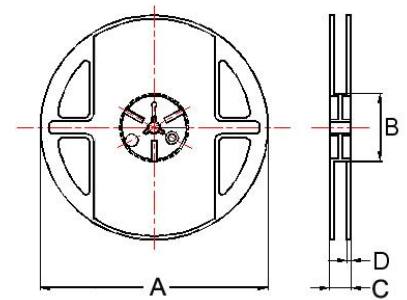

- ① : SBY / SBJ / NB / PB
- ② : SBY / SBJ / NB / PB / UPB / HF ③ : UPB
- ④ : SBK / SBJ / GB / PB / NB / UPB / VPB
- ⑤ : SBK / GB / PB / UPB ⑥ : SBY / SBK / PBY / UPB

Dimensions in mm

TYPE	Tape Dimensions								Reel Dimensions				Quantity PCS / REEL
	A	B	T	W	P	F	K	Tape	A	B	C	D	
①060303	0.37	0.67	0.42	8.0	2.0	3.5	-	B	178	60	10	2	15000
②100505	0.62	1.12	0.60	8.0	2.0	3.5	-	B	178	60	12	2	10000
③160805	1.05	1.85	0.60	8.0	2.0	3.5	-	B	178	60	12	2	10000
④160808	1.05	1.85	0.95	8.0	4.0	3.5	-	B	178	60	12	2	4000
⑤201209	1.50	2.30	0.97	8.0	4.0	3.5	-	B	178	60	12	2	4000
⑥321611	1.88	3.50	0.22	8.0	4.0	3.5	1.27	A	178	60	12	2	3000