

»Features

- 40Watts peak pulse power ($t_p = 8/20\mu s$)
- Tiny SOT143 package
- Bidirectional configurations
- Solid-state silicon-avalanche technology
- Low clamping voltage
- Low leakage current
- Low capacitance ($C_j=0.35pF$ typ I/O to I/O.)
- Protection one data/power line
- IEC 61000-4-2 $\pm 15kV$ contact $\pm 20kV$ air
- IEC 61000-4-4 (EFT) 40A (5/50ns)
- IEC 61000-4-5 (Lightning) 3.5A (8/20 μs)

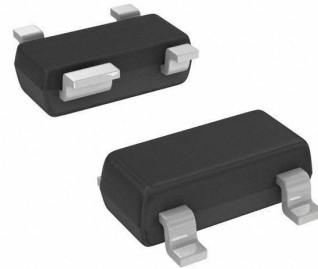

»Applications

- USB2.0,
- Ethernet
- Notebooks, Desktops, and Servers
- Video Line Protection

»Mechanical Data

- SOT143 package
- Molding compound flammability rating: UL94V-0
- Packaging: Tape and Reel
- RoHS/WEEE Compliant

»Schematic & PIN Configuration

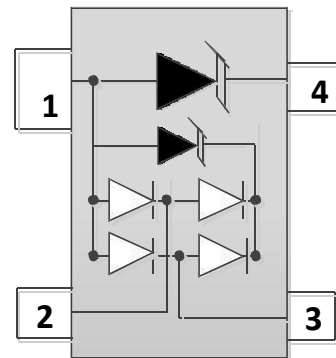
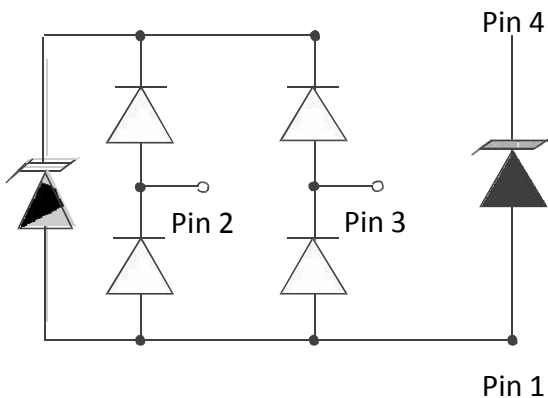

»Absolute Maximum Rating

Rating	Symbol	Value	Units
Peak Pulse Power ($t_p = 8/20\mu s$)	P_{PP}	40	Watts
Peak Pulse Current ($t_p = 8/20\mu s$) (note1)	I_{pp}	3.5	A
ESD per IEC 61000-4-2 (Air) ESD per IEC 61000-4-2 (Contact)	V_{ESD}	20 15	kV
Lead Soldering Temperature	T_L	260(10seconds)	°C
Junction Temperature	T_J	-55 to + 125	°C
Storage Temperature	T_{stg}	-55 to + 125	°C

»Electrical Characteristics

Parameter	Symbol	Conditions	Min	Typical	Max	Units
Reverse Stand-Off Voltage	V_{RWM}				5.0	V
Reverse Breakdown Voltage	V_{BR}	$I_T = 1mA$	6.0	7.2		V
Reverse Leakage Current	I_R	$V_{RWM} = 5V, T = 25^\circ C$		50	500	nA
Clamping Voltage	V_C	$I_{PP} = 3.5A, t_p = 8/20\mu s$		10		V
Junction Capacitance	C_j	$V_R = 0V, f = 1MHz$ IO to IO		0.35		pF
		$V_R = 0V, f = 1MHz$ IO to GND		0.65		

»Electrical Parameters (TA = 25°C unless otherwise noted)

Symbol	Parameter
I_{PP}	Maximum Reverse Peak Pulse Current
V_C	Clamping Voltage @ I_{PP}
V_{RWM}	Working Peak Reverse Voltage
I_R	Maximum Reverse Leakage Current @ V_{RWM}
V_{BR}	Breakdown Voltage @ I_T
I_T	Test Current

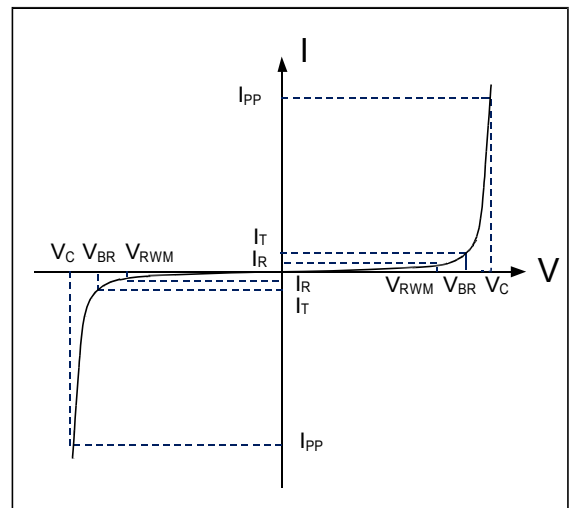

Note: 8/20μs pulse waveform.

»Typical Characteristics

Figure 1: Peak Pulse Power vs. Pulse Time

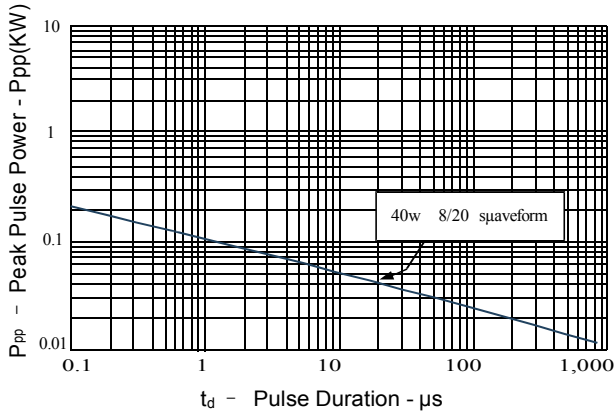

Figure 2: Power Derating Curve

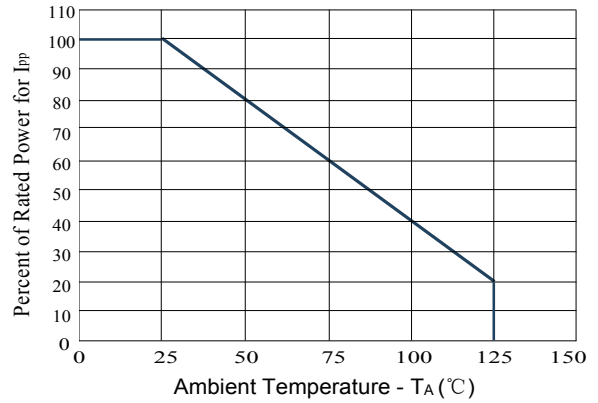

Figure3: Pulse Waveform

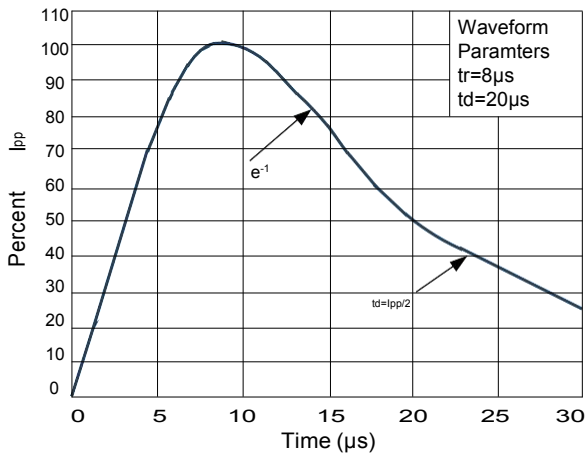
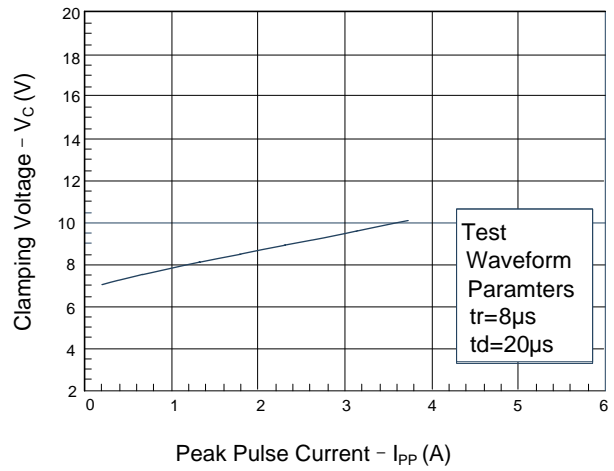
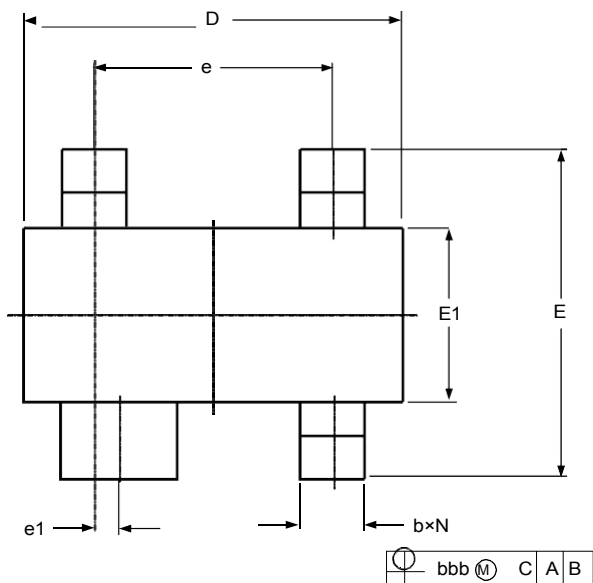

Figure 4: Clamping Voltage vs. Ipp



»Outline Drawing – SOT143



DIMENSIONS				
SYMBOL	MILLIMETER		INCHES	
	MIN	MAX	MIN	MAX
A	0.900	1.150	0.035	0.045
A1	0.000	0.100	0.000	0.004
A2	0.900	1.050	0.035	0.041
b	0.300	0.500	0.012	0.020
b1	0.750	0.900	0.030	0.035
D	2.800	3.000	0.110	0.118
e	1.800	2.000	0.071	0.079
e1	0.200TYP		0.008TYP	
E	2.250	2.550	0.089	0.100
E1	1.200	1.400	0.047	0.055
θ	0°	8°	0°	8°
aaa	.006		0.15	
bbb	.008		0.20	
ccc	.004		0.10	

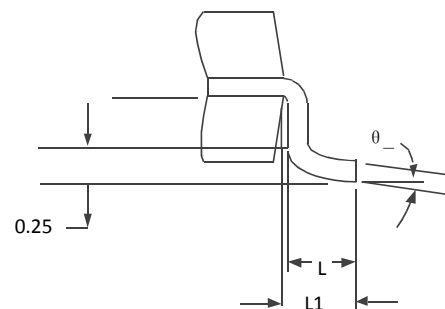
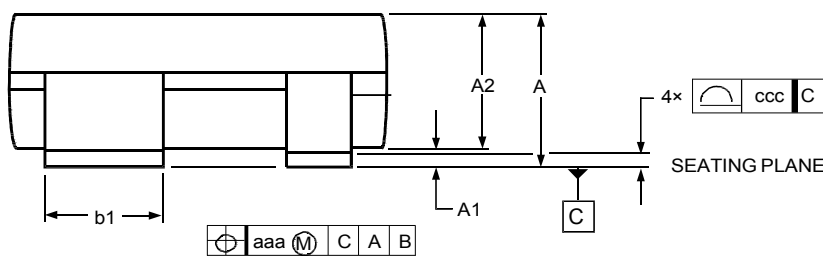

»Marking



»Ordering information

Order code	Package	Base qty	Delivery mode
PRTR5V0U2X-N	SOT143	3k	Tape and reel