

Specification for Approval

Date: 2013/03/15

Customer : 天河

TAI-TECH P/N: **FPI0705F-SERIES**

CUSTOMER P/N:

DESCRIPTION:

QUANTITY: _____ pcs

REMARK:		
Customer Approval Feedback		

西北臺慶科技股份有限公司
TAI-TECH Advanced Electronics Co., Ltd

西北臺慶科技股份有限公司
 TAI-TECH Advanced Electronics Co., Ltd
Headquarter:
 NO.1 YOU 4TH ROAD, YOUTH INDUSTRIAL DISTRICT, YANG-MEI,
 TAO-YUAN HSIEN, TAIWAN, R.O.C.
 TEL: +886-3-4641148 FAX: +886-3-4643565
 http://www.tai-tech.com.tw
 E-mail: sales@tai-tech.com.tw

東莞臺慶精密電子有限公司
 DONGGUAN TAI-TECH ADVANCED ELECTRONICS CO., LTD
 JITIGANG MANAGEMENT DISTRICT, HUANGJIANG, DONGGUAN,
 GUANGDONG, CHINA
 TEL: +86-769-3365488 FAX: +86-769-3366896
 E-mail: sales@tai-tech.net

Office:
 金亨國際有限公司
 KAMHENG INTERNATIONAL LIMITED
 TEL: +86-852-25772033 FAX: +86-852-28817778

臺慶精密電子(昆山)有限公司
 TAI-TECH ADVANCED ELECTRONICS(KUNSHAN) CO., LTD
 SHINWHA ROAD, KUNJIA HI-TECH INDUSTRIAL PARK, KUN-SHAN,
 JIANG-SU, CHINA
 TEL: +86-512-57619396 FAX: +86-512-57619688
 E-mail: sales@tai-tech.cn

Office:
 北欣國際有限公司
 NORTH STAR INTERNATIONAL LIMITED
 TEL: +86-512-57619396 FAX: +86-512-57619688

Sales Dep.

APPROVED	CHECKED
管哲頌 Eric Kuan	曾詩涵 Angela Tseng

R&D Center

APPROVED	CHECKED	DRAWN
楊祥忠 Mike Yang	羅培君 Peijun Lo	徐允珮 Shelly Hsu

SMD Type Power Inductor

FPI0705F-SERIES

1. Features

- 1.Excellent solderability and high heat resistance.
- 2.Excellent terminal strength construction.
- 3.Packed in embossed carrier tape and can be used by automatic mounting machine.
- 4.100% Lead(Pb) & Halogen-Free and RoHS compliant.



2. Dimension

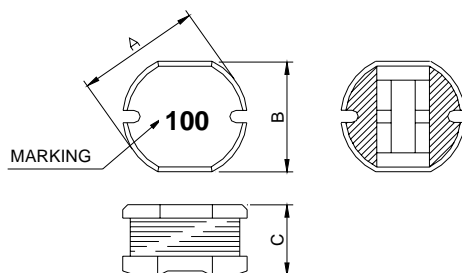

Size	A(mm)	B(mm)	C(mm)
FPI 0705	7.80±0.3	7.00±0.3	5.00±0.3

3. Part Numbering

FPI
0705
F
-
100
M

A B C D E

A: Series

B: Dimension

C: Lead free type

D: Inductance

100=10uH, 101=100uH

E: Inductance Tolerance

K=±10%, M=±20%

4. Specification

Customer Part Number	TAI-TECH Part Number	Inductance (uH)	Tolerance (%)	Test Frequency (Hz)	DCR (Ω) max.	IDC (A) max.
	FPI 0705F-100M	10	± 20%	1V/2.52M	0.07	2.30
⊙	FPI 0705F-120M	12	± 20%	1V/2.52M	0.08	2.00
	FPI 0705F-150M	15	± 20%	1V/2.52M	0.09	1.80
	FPI 0705F-180M	18	± 20%	1V/2.52M	0.10	1.60
	FPI 0705F-220M	22	± 20%	1V/2.52M	0.11	1.50
⊙	FPI 0705F-270M	27	± 20%	1V/2.52M	0.12	1.30
	FPI 0705F-330M	33	± 20%	1V/2.52M	0.13	1.20
	FPI 0705F-390M	39	± 20%	1V/2.52M	0.16	1.10
⊙	FPI 0705F-470K	47	± 10%	1V/2.52M	0.18	1.10
	FPI 0705F-560K	56	± 10%	1V/2.52M	0.24	0.94
	FPI 0705F-680K	68	± 10%	1V/2.52M	0.28	0.85
	FPI 0705F-820K	82	± 10%	1V/2.52M	0.37	0.78
	FPI 0705F-101K	100	± 10%	1V/1K	0.43	0.72

Customer Part Number	TAI-TECH Part Number	Inductance (uH)	Tolerance (%)	Test Frequency (Hz)	DCR (Ω) max.	IDC (A) max.
	FPI 0705F-121K	120	$\pm 10\%$	1V/1K	0.47	0.66
	FPI 0705F-151K	150	$\pm 10\%$	1V/1K	0.64	0.58
	FPI 0705F-181K	180	$\pm 10\%$	1V/1K	0.71	0.51
	FPI 0705F-221K	220	$\pm 10\%$	1V/1K	0.96	0.49
	FPI 0705F-271K	270	$\pm 10\%$	1V/1K	1.11	0.42
	FPI 0705F-331K	330	$\pm 10\%$	1V/1K	1.26	0.40
	FPI 0705F-391K	390	$\pm 10\%$	1V/1K	1.77	0.36
	FPI 0705F-471K	470	$\pm 10\%$	1V/1K	1.96	0.34

* IDC Test

For the parts with inductance under 82 uH , the L is measured at 1MHz then when a IDC current is applied, the L should drop less than 35%.

For the parts with inductance over 100 uH , the L is measured at 1KHz then when a IDC current is applied, the L should drop less than 35%.

For all FPI series ,when a IDC current is applied, the temperature rised of the parts is less than 40 degree C

5. Material List

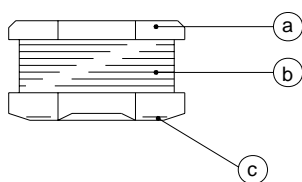

No.	Item	Material
1	Core	Ferrite DR Core
2	Wire	Enamelled Copper wire(155°C Class)
3	Terminal	Ag+Ni+Sn

6. Schematic Diagram

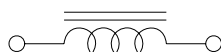

7. Reliability and Test Condition

Item	Performance	Test Condition
Operating Temperature	-25~+85℃	
Storage temperature	-25~+85℃ (For products in unopened tape package, less than 40℃)	
Rated Current	Base on temp. rise & $\Delta L/LOA \leq 35\%$	
Temperature Rise Test	40℃ typ. (Δt)	
Solderability	More than 90% of the terminal electrode shall be covered with fresh solder.	Preheat : 150±25℃ for 60 secs Solder : Sn-Ag3.0-Cu0.5 Solder Temp.:245±5℃ Flux : Rosin Dip Time : 4±1 secs
Thermal Shock Test (Temp. Cycle) MIL-STD-202G METHOD 107	Inductance shall not change more than ±10%	ROOM TEMP. → -55±2℃ 5 MINUTES → 30 MINUTES ROOM TEMP. → 85±2℃ 5 MINUTES → 30 MINUTES Total: 100cycle
Humidity Resistance Test MIL-STD-202G METHOD 103	Inductance shall not change more than ±10%	Temperature : 40±2℃ Humidity : 90-95% Applied Current : per spec. Time : 500±8 hrs
High Temperature Resistance Test MIL-STD-202G METHOD 108	Inductance shall not change more than ±10%	Temperature : 85±2℃ Applied Current : per spec. Time : 500±8 hrs
Random Vibration Test	Appearance: Cracking, shipping and any other defects harmful to the characteristics should not be allowed. Inductance: within±30%	Frequency: 10-55-10Hz for 1 min. Amplitude: 1.52mm Directions and times: X, Y, Z directions for 2 hours. A period of 2 hours in each of 3 mutually perpendicular directions (Total 6 hours).

8. Recommended PC Board Pattern

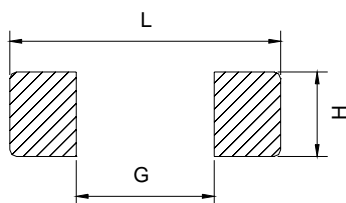

L(mm)	G(mm)	H(mm)
8.0	2.0	7.5

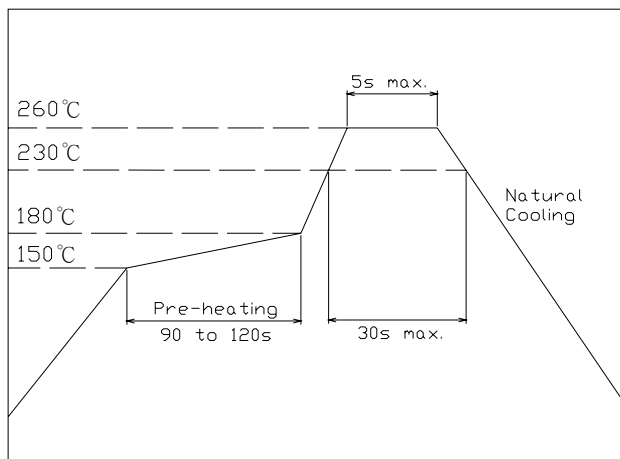

9. Packaging Information

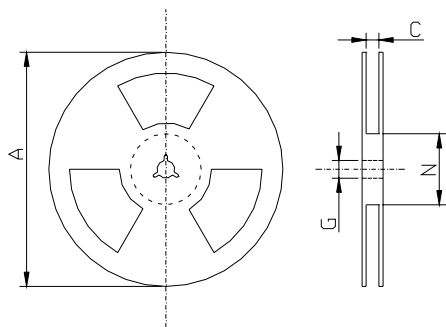

Style	A(mm)	C(mm)	G(mm)	N(mm)
13"X16mm	330	18 ⁺⁰	13.5±0.5	50 ⁰

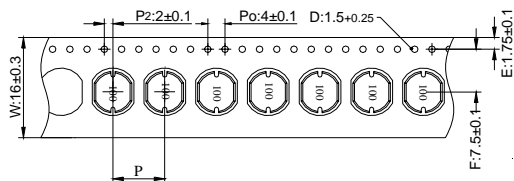

Style	W(mm)	P(mm)	D(mm)	Packaging Qty(pcs)
16 mm	16±0.3	12±0.1	1.5±0.25	1,000

Application Notice

- Storage Conditions

To maintain the solderability of terminal electrodes:

1. TAI-TECH products meet IPC/JEDEC J-STD-020D standard-MSL, level 1

1. Temperature and humidity conditions: Less than 40°C and 60% RH.

2. Recommended products should be used within 12 months form the time of delivery.

3. The packaging material should be kept where no chlorine or sulfur exists in the air.

- Transportation

1. Products should be handled with care to avoid damage or contamination from perspiration and skin oils.

2. The use of tweezers or vacuum pick up is strongly recommended for individual components.

3. Bulk handling should ensure that abrasion and mechanical shock are minimized.

測試報告 Test Report

號碼(No.) : CE/2012/54920 日期(Date) : 2012/05/31 頁數(Page) : 1 of 8

西北臺慶科技股份有限公司 / TAI-TECH ADVANCED ELECTRONICS CO., LTD. 
 (東莞臺慶精密電子有限公司 / TAI-TECH ADVANCED ELECTRONICS (DONGGUAN) CO. LTD.)
 (臺慶精密電子(昆山)有限公司 / TAI-TECH ADVANCED ELECTRONICS (KUN-SHAN) CO. LTD.)
 桃園縣楊梅市幼獅工業區幼四路1之1號 / NO. 1, YOU 4TH ROAD, YOUTH INDUSTRIAL DISTRICT, YANG-MEI CITY,
 TAO-YUAN HSIEN, TAIWAN R. O. C.)
 (廣東省東莞市黃江鎮黃牛埔福祥街2號 / NO. 2, FUXIANG STREET, HUANGNIUPU, HUANGJIANG TOWN, DONGGUAN, GUANGDONG)
 (江蘇省昆山市蓬朗昆嘉高科技工業區郭澤路 / GUO-ZE ROAD, KUNJIA HI-TECH INDUSTRIAL PARK, KUN-SHAN, JIANG-SU,
 CHINA)

以下測試樣品係由客戶送樣，且由客戶聲稱並經客戶確認如下 (The following samples was/were submitted and identified by/on behalf of the client as):

樣品名稱(Sample Description) : WINDING POWER INDUCTOR, SMD POWER INDUCTOR
 樣品型號(Style/Item No.) : LQC, LQN, FPI, FPIP, FPIG SERIES
 收件日期(Sample Receiving Date) : 2012/05/24
 測試期間(Testing Period) : 2012/05/24 TO 2012/05/31

=====
 測試結果(Test Results) : 請見下一頁 (Please refer to next pages).



Chenyu Kung / Operation Manager
 Signed for and on behalf of
 SGS TAIWAN LTD.
 Chemical Laboratory – Taipei

Unless otherwise stated the results shown in this test report refer only to the sample(s) tested. This test report cannot be reproduced, except in full, without prior written permission of the Company. 除非另有說明，此報告結果僅對測試之樣品負責。本報告未經本公司書面許可，不可部分複製。
 This document is issued by the Company subject to its General Conditions of Service printed overleaf, available on request or accessible at www.sgs.com/terms_and_conditions.htm and, for electronic format documents, subject to Terms and Conditions for Electronic Documents at www.sgs.com/en/Terms-and-Conditions/Terms-e-Document. Attention is drawn to the limitation of liability, indemnification and jurisdiction issues defined therein. Any holder of this document is advised that information contained hereon reflects the Company's findings at the time of its intervention only and within the limits of Client's instructions, if any. The Company's sole responsibility is to its Client and this document does not exonerate parties to a transaction from exercising all their rights and obligations under the transaction documents. This document cannot be reproduced except in full, without prior written approval of the Company. Any unauthorized alteration, forgery or falsification of the content or appearance of this document is unlawful and offenders may be prosecuted to the fullest extent of the law.

測試報告

Test Report

號碼(No.) : CE/2012/54920 日期(Date) : 2012/05/31 頁數(Page) : 2 of 8

西北臺慶科技股份有限公司 / TAI-TECH ADVANCED ELECTRONICS CO., LTD. 

(東莞臺慶精密電子有限公司 / TAI-TECH ADVANCED ELECTRONICS (DONGGUAN) CO. LTD.)

(臺慶精密電子(昆山)有限公司 / TAI-TECH ADVANCED ELECTRONICS (KUN-SHAN) CO. LTD.)

桃園縣楊梅市幼獅工業區幼四路1之1號 / NO. 1, YOU 4TH ROAD, YOUTH INDUSTRIAL DISTRICT, YANG-MEI CITY, TAO-YUAN HSIEN, TAIWAN R. O. C.)

(廣東省東莞市黃江鎮黃牛埔福祥街2號 / NO. 2, FUXIANG STREET, HUANGNIUPU, HUANGJIANG TOWN, DONGGUAN, GUANGDONG)

(江蘇省昆山市蓬朗昆嘉高科技工業區郭澤路 / GUO-ZE ROAD, KUNJIA HI-TECH INDUSTRIAL PARK, KUN-SHAN, JIANG-SU, CHINA)

測試結果(Test Results)

測試部位(PART NAME) No.1 : 整體混測(5款) (MIXED ALL PARTS(5 TYPES))

測試項目 (Test Items)	單位 (Unit)	測試方法 (Method)	方法偵測 極限值 (MDL)	結果 (Result)
				No.1
鎘 / Cadmium (Cd)	mg/kg	參考IEC 62321: 2008方法, 以感應耦合電漿原子發射光譜儀檢測。 / With reference to IEC 62321: 2008 and performed by ICP-AES.	2	n.d.
鉛 / Lead (Pb)	mg/kg	參考IEC 62321: 2008方法, 以感應耦合電漿原子發射光譜儀檢測。 / With reference to IEC 62321: 2008 and performed by ICP-AES.	2	n.d.
汞 / Mercury (Hg)	mg/kg	參考IEC 62321: 2008方法, 以感應耦合電漿原子發射光譜儀檢測。 / With reference to IEC 62321: 2008 and performed by ICP-AES.	2	n.d.
六價鉻 / Hexavalent Chromium Cr(VI)	mg/kg	參考IEC 62321: 2008方法, 以UV-VIS檢測。 / With reference to IEC 62321: 2008 and performed by UV-VIS.	2	n.d.
鹵素 / Halogen				
鹵素(氟) / Halogen-Fluorine (F) (CAS No.: 14762-94-8)	mg/kg	參考BS EN 14582:2007, 以離子層析儀分析。 / With reference to BS EN 14582:2007. Analysis was performed by IC.	50	n.d.
鹵素(氯) / Halogen-Chlorine (Cl) (CAS No.: 22537-15-1)			50	n.d.
鹵素(溴) / Halogen-Bromine (Br) (CAS No.: 10097-32-2)			50	n.d.
鹵素(碘) / Halogen-Iodine (I) (CAS No.: 14362-44-8)			50	n.d.

Unless otherwise stated the results shown in this test report refer only to the sample(s) tested. This test report cannot be reproduced, except in full, without prior written permission of the Company. 除非另有說明, 此報告結果僅對測試之樣品負責。本報告未經本公司書面許可, 不可部分複製。

This document is issued by the Company subject to its General Conditions of Service printed overleaf, available on request or accessible at www.sgs.com/terms_and_conditions.htm and, for electronic format documents, subject to Terms and Conditions for Electronic Documents at www.sgs.com/en/Terms-and-Conditions/Terms-e-Documents. Attention is drawn to the limitation of liability, indemnification and jurisdiction issues defined therein. Any holder of this document is advised that information contained hereon reflects the Company's findings at the time of its intervention only and within the limits of Client's instructions, if any. The Company's sole responsibility is to its Client and this document does not exonerate parties to a transaction from exercising all their rights and obligations under the transaction documents. This document cannot be reproduced except in full, without prior written approval of the Company. Any unauthorized alteration, forgery or falsification of the content or appearance of this document is unlawful and offenders may be prosecuted to the fullest extent of the law.

測試報告

Test Report

號碼(No.) : CE/2012/54920 日期(Date) : 2012/05/31 頁數(Page) : 3 of 8

西北臺慶科技股份有限公司 / TAI-TECH ADVANCED ELECTRONICS CO., LTD.



(東莞臺慶精密電子有限公司 / TAI-TECH ADVANCED ELECTRONICS (DONGGUAN) CO. LTD.)

(臺慶精密電子(昆山)有限公司 / TAI-TECH ADVANCED ELECTRONICS (KUN-SHAN) CO. LTD.)

桃園縣楊梅市幼獅工業區幼四路1之1號 / NO. 1, YOU 4TH ROAD, YOUTH INDUSTRIAL DISTRICT, YANG-MEI CITY, TAO-YUAN HSIEN, TAIWAN R. O. C.)

(廣東省東莞市黃江鎮黃牛埔福祥街2號 / NO. 2, FUXIANG STREET, HUANGNIUPU, HUANGJIANG TOWN, DONGGUAN, GUANGDONG)

(江蘇省昆山市蓬朗昆嘉高科技工業區郭澤路 / GUO-ZE ROAD, KUNJIA HI-TECH INDUSTRIAL PARK, KUN-SHAN, JIANG-SU, CHINA)

測試項目 (Test Items)	單位 (Unit)	測試方法 (Method)	方法偵測 極限值	結果 (Result)
			(MDL)	No. 1
多溴聯苯總和 / Sum of PBBs	mg/kg	參考IEC 62321: 2008方法, 以氣相層析/質譜儀檢測. / With reference to IEC 62321: 2008 and performed by GC/MS.	-	n.d.
一溴聯苯 / Monobromobiphenyl			5	n.d.
二溴聯苯 / Dibromobiphenyl			5	n.d.
三溴聯苯 / Tribromobiphenyl			5	n.d.
四溴聯苯 / Tetrabromobiphenyl			5	n.d.
五溴聯苯 / Pentabromobiphenyl			5	n.d.
六溴聯苯 / Hexabromobiphenyl			5	n.d.
七溴聯苯 / Heptabromobiphenyl			5	n.d.
八溴聯苯 / Octabromobiphenyl			5	n.d.
九溴聯苯 / Nonabromobiphenyl			5	n.d.
十溴聯苯 / Decabromobiphenyl			5	n.d.
多溴聯苯醚總和 / Sum of PBDEs			-	n.d.
一溴聯苯醚 / Monobromodiphenyl ether			5	n.d.
二溴聯苯醚 / Dibromodiphenyl ether			5	n.d.
三溴聯苯醚 / Tribromodiphenyl ether			5	n.d.
四溴聯苯醚 / Tetrabromodiphenyl ether			5	n.d.
五溴聯苯醚 / Pentabromodiphenyl ether			5	n.d.
六溴聯苯醚 / Hexabromodiphenyl ether			5	n.d.
七溴聯苯醚 / Heptabromodiphenyl ether			5	n.d.
八溴聯苯醚 / Octabromodiphenyl ether			5	n.d.
九溴聯苯醚 / Nonabromodiphenyl ether	5	n.d.		
十溴聯苯醚 / Decabromodiphenyl ether	5	n.d.		

Unless otherwise stated the results shown in this test report refer only to the sample(s) tested. This test report cannot be reproduced, except in full, without prior written permission of the Company. 除非另有說明, 此報告結果僅對測試之樣品負責。本報告未經本公司書面許可, 不可部分複製。
This document is issued by the Company subject to its General Conditions of Service printed overleaf, available on request or accessible at www.sgs.com/terms_and_conditions.htm and, for electronic format documents, subject to Terms and Conditions for Electronic Documents at www.sgs.com/en/Terms-and-Conditions/Terms-e-Documents. Attention is drawn to the limitation of liability, indemnification and jurisdiction issues defined therein. Any holder of this document is advised that information contained hereon reflects the Company's findings at the time of its intervention only and within the limits of Client's instructions, if any. The Company's sole responsibility is to its Client and this document does not exonerate parties to a transaction from exercising all their rights and obligations under the transaction documents. This document cannot be reproduced except in full, without prior written approval of the Company. Any unauthorized alteration, forgery or falsification of the content or appearance of this document is unlawful and offenders may be prosecuted to the fullest extent of the law.



測試報告 Test Report

號碼(No.) : CE/2012/54920 日期(Date) : 2012/05/31 頁數(Page) : 4 of 8

西北臺慶科技股份有限公司 / TAI-TECH ADVANCED ELECTRONICS CO., LTD.



(東莞臺慶精密電子有限公司 / TAI-TECH ADVANCED ELECTRONICS (DONGGUAN) CO. LTD.)

(臺慶精密電子(昆山)有限公司 / TAI-TECH ADVANCED ELECTRONICS (KUN-SHAN) CO. LTD.)

桃園縣楊梅市幼獅工業區幼四路1之1號 / NO. 1, YOU 4TH ROAD, YOUTH INDUSTRIAL DISTRICT, YANG-MEI CITY, TAO-YUAN HSIEN. TAIWAN R. O. C.)

(廣東省東莞市黃江鎮黃牛埔福祥街2號 / NO. 2, FUXIANG STREET, HUANGNIUPU, HUANGJIANG TOWN, DONGGUAN, GUANGDONG)

(江蘇省昆山市蓬朗昆嘉高科技工業區郭澤路 / GUO-ZE ROAD, KUNJIA HI-TECH INDUSTRIAL PARK, KUN-SHAN, JIANG-SU, CHINA)

備註(Note) :

1. mg/kg = ppm ; 0.1wt% = 1000ppm
2. n.d. = Not Detected (未檢出)
3. MDL = Method Detection Limit (方法偵測極限值)
4. "-" = Not Regulated (無規格值)
5. 樣品的測試是基於申請人要求混合測試，報告中的混合測試結果不代表其中個別單一材質的含量。
(The samples was/were analyzed on behalf of the applicant as mixing sample in one testing.
The above results was/were only given as the informality value.)

Unless otherwise stated the results shown in this test report refer only to the sample(s) tested. This test report cannot be reproduced, except in full, without prior written permission of the Company. 除非另有說明，此報告結果僅對測試之樣品負責。本報告未經本公司書面許可，不可部分複製。
This document is issued by the Company subject to its General Conditions of Service printed overleaf, available on request or accessible at www.sgs.com/terms_and_conditions.htm and, for electronic format documents, subject to Terms and Conditions for Electronic Documents at www.sgs.com/en/Terms-and-Conditions/Terms-e-Documents. Attention is drawn to the limitation of liability, indemnification and jurisdiction issues defined therein. Any holder of this document is advised that information contained hereon reflects the Company's findings at the time of its intervention only and within the limits of Client's instructions, if any. The Company's sole responsibility is to its Client and this document does not exonerate parties to a transaction from exercising all their rights and obligations under the transaction documents. This document cannot be reproduced except in full, without prior written approval of the Company. Any unauthorized alteration, forgery or falsification of the content or appearance of this document is unlawful and offenders may be prosecuted to the fullest extent of the law.

測試報告 Test Report

號碼(No.) : CE/2012/54920 日期(Date) : 2012/05/31 頁數(Page) : 5 of 8

西北臺慶科技股份有限公司 / TAI-TECH ADVANCED ELECTRONICS CO., LTD.

(東莞臺慶精密電子有限公司 / TAI-TECH ADVANCED ELECTRONICS (DONGGUAN) CO. LTD.)

(臺慶精密電子(昆山)有限公司 / TAI-TECH ADVANCED ELECTRONICS (KUN-SHAN) CO. LTD.)

桃園縣楊梅市幼獅工業區幼四路1之1號 / NO. 1, YOU 4TH ROAD, YOUTH INDUSTRIAL DISTRICT, YANG-MEI CITY, TAO-YUAN HSIEN, TAIWAN R. O. C.)

(廣東省東莞市黃江鎮黃牛埔福祥街2號 / NO. 2, FUXIANG STREET, HUANGNIUPU, HUANGJIANG TOWN, DONGGUAN, GUANGDONG)

(江蘇省昆山市蓬朗昆嘉高科技工業區郭澤路 / GUO-ZE ROAD, KUNJIA HI-TECH INDUSTRIAL PARK, KUN-SHAN, JIANG-SU, CHINA)



- 1) 根據以下的流程圖之條件，樣品已完全溶解。(六價鉻測試方法除外) / These samples were dissolved totally by pre-conditioning method according to below flow chart. (Cr⁶⁺ test method excluded)
- 2) 測試人員：楊登偉 / Name of the person who made measurement: Climbgreat Yang
- 3) 測試負責人：張啓興 / Name of the person in charge of measurement: Troy Chang

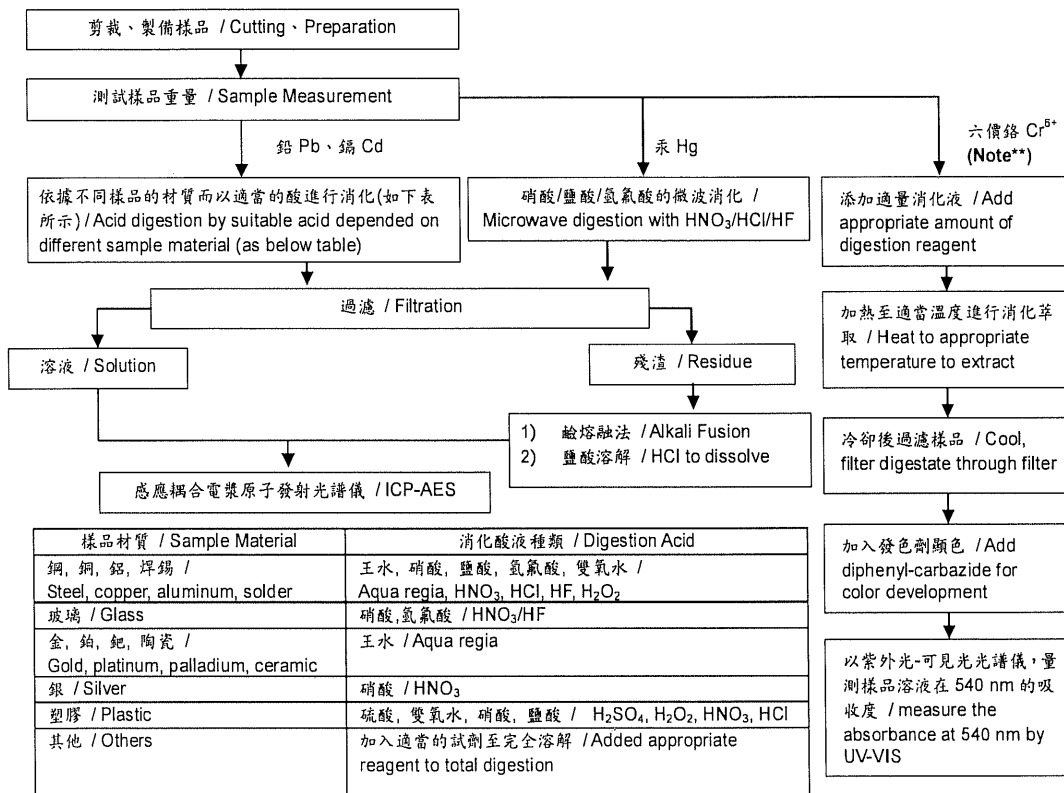

Note**: (1) 針對非金屬材料加入鹼性消化液, 加熱至 90~95°C 萃取. / For non-metallic material, add alkaline digestion reagent and heat to 90~95°C.
 (2) 針對金屬材料加入純水, 加熱至沸騰萃取. / For metallic material, add pure water and heat to boiling.

Unless otherwise stated the results shown in this test report refer only to the sample(s) tested. This test report cannot be reproduced, except in full, without prior written permission of the Company. 除非另有說明, 此報告結果僅對測試之樣品負責。本報告未經本公司書面許可, 不可部分複製。
 This document is issued by the Company subject to its General Conditions of Service printed overleaf, available on request or accessible at www.sgs.com/terms_and_conditions.htm and, for electronic format documents, subject to Terms and Conditions for Electronic Documents at www.sgs.com/en/Terms-and-Conditions/Terms-e-Document. Attention is drawn to the limitation of liability, indemnification and jurisdiction issues defined therein. Any holder of this document is advised that information contained hereon reflects the Company's findings at the time of its intervention only and within the limits of Client's instructions, if any. The Company's sole responsibility is to its Client and this document does not exonerate parties to a transaction from exercising all their rights and obligations under the transaction documents. This document cannot be reproduced except in full, without prior written approval of the Company. Any unauthorized alteration, forgery or falsification of the content or appearance of this document is unlawful and offenders may be prosecuted to the fullest extent of the law.

測試報告

Test Report

號碼(No.) : CE/2012/54920 日期(Date) : 2012/05/31 頁數(Page) : 6 of 8

西北臺慶科技股份有限公司 / TAI-TECH ADVANCED ELECTRONICS CO., LTD.
 (東莞臺慶精密電子有限公司 / TAI-TECH ADVANCED ELECTRONICS (DONGGUAN) CO. LTD.)
 (臺慶精密電子(昆山)有限公司 / TAI-TECH ADVANCED ELECTRONICS (KUN-SHAN) CO. LTD.)
 桃園縣楊梅市幼獅工業區幼四路1之1號 / NO. 1, YOU 4TH ROAD, YOUTH INDUSTRIAL DISTRICT, YANG-MEI CITY, TAO-YUAN HSIEN, TAIWAN R. O. C.)
 (廣東省東莞市黃江鎮黃牛埔福祥街2號 / NO. 2, FUXIANG STREET, HUANGNIUPU, HUANGJIANG TOWN, DONGGUAN, GUANGDONG)
 (江蘇省昆山市蓬朗昆嘉高科技工業區郭澤路 / GUO-ZE ROAD, KUNJIA HI-TECH INDUSTRIAL PARK, KUN-SHAN, JIANG-SU, CHINA)



多溴聯苯/多溴聯苯醚分析流程圖 / PBB/PBDE analytical FLOW CHART

- 測試人員：翁賜彬 / Name of the person who made measurement: Roman Wong
 - 測試負責人：張啓興 / Name of the person in charge of measurement: Troy Chang
- 初次測試程序 / First testing process —————>
- 選擇性篩檢程序 / Optional screen process>
- 確認程序 / Confirmation process - - ->

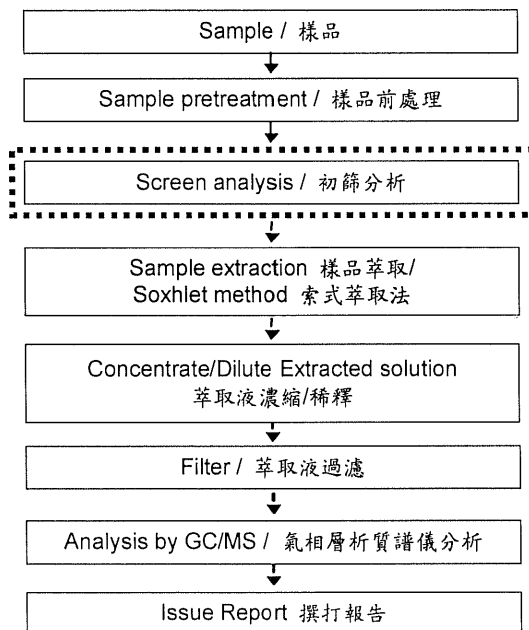

Unless otherwise stated the results shown in this test report refer only to the sample(s) tested. This test report cannot be reproduced, except in full, without prior written permission of the Company. 除非另有說明，此報告結果僅對測試之樣品負責。本報告未經本公司書面許可，不可部分複製。
 This document is issued by the Company subject to its General Conditions of Service printed overleaf, available on request or accessible at www.sgs.com/terms_and_conditions.htm and, for electronic format documents, subject to Terms and Conditions for Electronic Documents at www.sgs.com/en/Terms-and-Conditions/Terms-e-Document. Attention is drawn to the limitation of liability, indemnification and jurisdiction issues defined therein. Any holder of this document is advised that information contained hereon reflects the Company's findings at the time of its intervention only and within the limits of Client's instructions, if any. The Company's sole responsibility is to its Client and this document does not exonerate parties to a transaction from exercising all their rights and obligations under the transaction documents. This document cannot be reproduced except in full, without prior written approval of the Company. Any unauthorized alteration, forgery or falsification of the content or appearance of this document is unlawful and offenders may be prosecuted to the fullest extent of the law.

測試報告 Test Report

號碼(No.) : CE/2012/54920 日期(Date) : 2012/05/31 頁數(Page) : 7 of 8

西北臺慶科技股份有限公司 / TAI-TECH ADVANCED ELECTRONICS CO., LTD.



(東莞臺慶精密電子有限公司 / TAI-TECH ADVANCED ELECTRONICS (DONGGUAN) CO. LTD.)

(臺慶精密電子(昆山)有限公司 / TAI-TECH ADVANCED ELECTRONICS (KUN-SHAN) CO. LTD.)

桃園縣楊梅市幼獅工業區幼四路1之1號 / NO. 1, YOU 4TH ROAD, YOUTH INDUSTRIAL DISTRICT, YANG-MEI CITY, TAO-YUAN HSIEN, TAIWAN R. O. C.)

(廣東省東莞市黃江鎮黃牛埔福祥街2號 / NO. 2, FUXIANG STREET, HUANGNIUPU, HUANGJIANG TOWN, DONGGUAN, GUANGDONG)

(江蘇省昆山市蓬朗昆嘉高科技工業區郭澤路 / GUO-ZE ROAD, KUNJIA HI-TECH INDUSTRIAL PARK, KUN-SHAN, JIANG-SU, CHINA)

鹵素分析流程圖 / Analytical flow chart of halogen content

- 測試人員：陳恩臻 / Name of the person who made measurement: Rita Chen
- 測試負責人：張啓興 / Name of the person in charge of measurement: Troy Chang

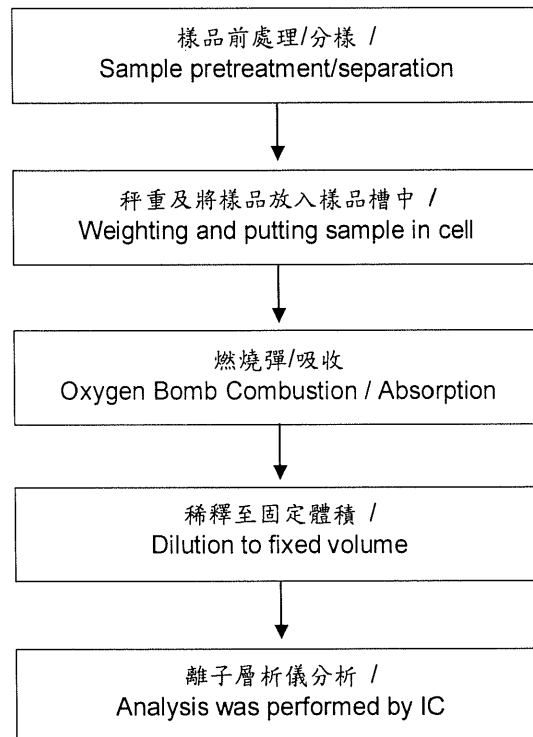

Unless otherwise stated the results shown in this test report refer only to the sample(s) tested. This test report cannot be reproduced, except in full, without prior written permission of the Company. 除非另有說明，此報告結果僅對測試之樣品負責。本報告未經本公司蓋印許可，不可部分複製。
This document is issued by the Company subject to its General Conditions of Service printed overleaf, available on request or accessible at www.sgs.com/terms_and_conditions.htm and, for electronic format documents, subject to Terms and Conditions for Electronic Documents at www.sgs.com/en/Terms-and-Conditions/Terms-e-Documents. Attention is drawn to the limitation of liability, indemnification and jurisdiction issues defined therein. Any holder of this document is advised that information contained hereon reflects the Company's findings at the time of its intervention only and within the limits of Client's instructions, if any. The Company's sole responsibility is to its Client and this document does not exonerate parties to a transaction from exercising all their rights and obligations under the transaction documents. This document cannot be reproduced except in full, without prior written approval of the Company. Any unauthorized alteration, forgery or falsification of the content or appearance of this document is unlawful and offenders may be prosecuted to the fullest extent of the law.

測試報告 Test Report

號碼(No.) : CE/2012/54920 日期(Date) : 2012/05/31 頁數(Page) : 8 of 8

西北臺慶科技股份有限公司 / TAI-TECH ADVANCED ELECTRONICS CO., LTD.



(東莞臺慶精密電子有限公司 / TAI-TECH ADVANCED ELECTRONICS (DONGGUAN) CO. LTD.)

(臺慶精密電子(昆山)有限公司 / TAI-TECH ADVANCED ELECTRONICS (KUN-SHAN) CO. LTD.)

桃園縣楊梅市幼獅工業區幼四路1之1號 / NO. 1, YOU 4TH ROAD, YOUTH INDUSTRIAL DISTRICT, YANG-MEI CITY, TAO-YUAN HSIEN. TAIWAN R. O. C.)

(廣東省東莞市黃江鎮黃牛埔福祥街2號 / NO. 2, FUXIANG STREET, HUANGNIUPU, HUANGJIANG TOWN, DONGGUAN, GUANGDONG)

(江蘇省昆山市蓬朗昆嘉高科技工業區郭澤路 / GUO-ZE ROAD, KUNJIA HI-TECH INDUSTRIAL PARK, KUN-SHAN, JIANG-SU, CHINA)

* 照片中如有箭頭標示，則表示為實際檢測之樣品/部位。*

(The tested sample / part is marked by an arrow if it's shown on the photo.)

CE/2012/54920

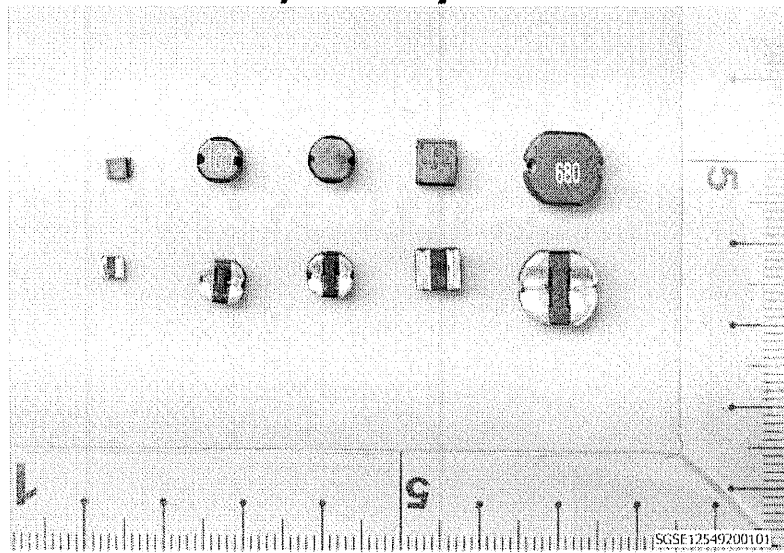

** 報告結尾(End of Report) **

Unless otherwise stated the results shown in this test report refer only to the sample(s) tested. This test report cannot be reproduced, except in full, without prior written permission of the Company. 除非另有說明，此報告結果僅對測試之樣品負責。本報告未經本公司書面許可，不可部分複製。
This document is issued by the Company subject to its General Conditions of Service printed overleaf, available on request or accessible at www.sgs.com/terms_and_conditions.htm and, for electronic format documents, subject to Terms and Conditions for Electronic Documents at www.sgs.com/en/Terms-and-Conditions/Terms-e-Document. Attention is drawn to the limitation of liability, indemnification and jurisdiction issues defined therein. Any holder of this document is advised that information contained hereon reflects the Company's findings at the time of its intervention only and within the limits of Client's instructions, if any. The Company's sole responsibility is to its Client and this document does not exonerate parties to a transaction from exercising all their rights and obligations under the transaction documents. This document cannot be reproduced except in full, without prior written approval of the Company. Any unauthorized alteration, forgery or falsification of the content or appearance of this document is unlawful and offenders may be prosecuted to the fullest extent of the law.