

# Specification for Approval

**Date:** 2016/10/04

**Customer :** 深圳臺慶

**TAI-TECH P/N:** HPC6028NF-Series

**CUSTOMER P/N:** \_\_\_\_\_

**DESCRIPTION:** \_\_\_\_\_

**QUANTITY:** \_\_\_\_\_ pcs

<b>REMARK:</b>		
Customer Approval Feedback		

- 西北臺慶科技股份有限公司  
 TAI-TECH Advanced Electronics Co., Ltd  
**Headquarter:**  
 NO.1 YOU 4TH ROAD, YOUTH INDUSTRIAL DISTRICT, YANG-MEI,  
 TAO-YUAN HSIEN, TAIWAN, R.O.C.  
 TEL: +886-3-4641148 FAX: +886-3-4643565  
 http://www.tai-tech.com.tw  
 E-mail: sales@tai-tech.com.tw

- Office:**  
 深圳辦公室  
 11BC, Building B Fortune Plaza, NO.7002, Shennan Avenue, Futian  
 District Shenzhen  
 TEL: +86-755-23972371 FAX: +86-755-23972340

- 臺慶精密電子(昆山)有限公司  
 TAI-TECH ADVANCED ELECTRONICS(KUNSHAN) CO., LTD  
 SHINWHA ROAD, KUNJIA HI-TECH INDUSTRIAL PARK, KUN-SHAN,  
 JIANG-SU, CHINA  
 TEL: +86-512-57619396 FAX: +86-512-57619688  
 E-mail: sales@tai-tech.cn

- Office:**  
 北欣國際有限公司  
 NORTH STAR INTERNATIONAL LIMITED  
 TEL: +86-512-57619396 FAX: +86-512-57619688

- 慶邦電子元件(泗洪)有限公司  
 TAIPAQ ELECTRONICS (SIHONG) CO., LTD  
 Sihong development zone Suqian City, Jiangsu, CHINA.  
 TEL: +86-527-88601191 FAX: +86-527-88601190  
 E-mail: sales@taipaq.cn

**Sales Dep.**

APPROVED	CHECKED
管哲頌 Eric Kuan	曾詩涵 Angela Tseng

**R&D Center**

APPROVED	CHECKED	DRAWN
楊祥忠 Mike Yang	詹偉特 Jack Chan	何秦芝 Sharon Ho



**SMD Power Inductor**

**HPC6028NF-Series**

**1. Features**

1. This specification applies Low Profile Power Inductors.
2. 100% Lead(Pb) & Halogen-Free and RoHS compliant.



**2. Dimension**

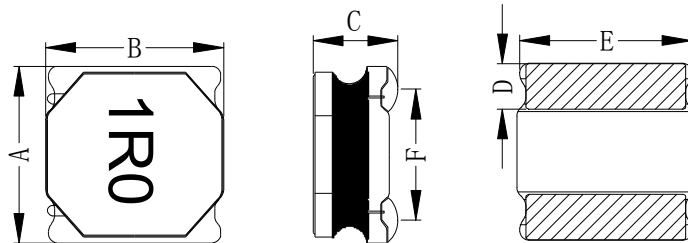

Series	*A(mm)	*B(mm)	*C(mm)	D(mm)	E(mm)	F(mm)
HPC6028NF	6.0±0.2	6.0±0.2	2.6±0.2	1.6±0.3	5.8±0.3	4.3ref

\*Dimensions are not including the termination. For maximum overall dimensions with termination, add 0.1mm.

**Recommended Land pattern**

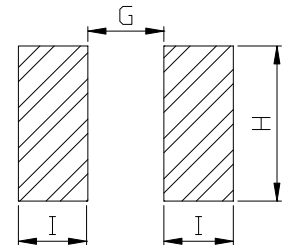

G(mm)	H(mm)	I(mm)
2.5	5.8	1.8

Note: 1. The above PCB layout reference only.  
2. Recommend solder paste thickness at 0.15mm and above.

**3. Part Numbering**



- A: Series
- B: Dimension
- C: Type
- D: Inductance
- E: Inductance Tolerance

A/B\*C

1R0=1.00uh 100=10uh,101=100uh,102=1000uh  
K=±10%, L=±15%,M=±20%,Y=±30%.

marking direction cannot decide polarity. Color: Black, unidirectional.  
magnetic shielding

## 4. Specification

Part Number	Inductance L0 (uH) @ 0 A	Tolerance	Rated current		DCR (mΩ) @25°C ±20%.
			Temperature current I rms (A)	Saturation current I sat (A)	
HPC6028NF-1R0Y	1.00	±30%	5.20	5.75	10.0
HPC6028NF-1R5Y	1.50	±30%	4.95	5.30	14.0
HPC6028NF-2R2M	2.20	±20%	4.50	5.00	18.0
HPC6028NF-3R3M	3.30	±20%	3.60	4.30	24.0
HPC6028NF-4R7M	4.70	±20%	3.10	3.20	30.0
HPC6028NF-6R8M	6.80	±20%	2.50	2.85	47.0
HPC6028NF-100M	10.0	±20%	2.00	2.10	65.0
HPC6028NF-150M	15.0	±20%	1.80	2.00	98.0
HPC6028NF-220M	22.0	±20%	1.50	1.60	138
HPC6028NF-330M	33.0	±20%	1.30	1.40	200
HPC6028NF-470M	47.0	±20%	1.06	1.15	280
HPC6028NF-680M	68.0	±20%	0.81	1.00	420
HPC6028NF-101M	100	±20%	0.72	0.80	605

Note:

1. All test data referenced to 25°C ambient , Ls:100KHz/1V.
2. Testing Instrument : HP4284A,CH11025,CH3302,CH1320 ,CH1320S LCR METER / Rdc:CH502BC MICRO OHMMETER.
3. Heat Rated Current (Irms) will cause the coil temperature rise approximately Δt of 40°C
4. Saturation Current (Isat) will cause L0 to drop approximately 30%
5. The part temperature (ambient + temp rise) should not exceed 125°C under worst case operating conditions.Circuit design,component,PCB trace size and thickness,airflow and other cooling provisions all affect the part temperature. Part temperature should be verified in the end application.
6. Special inquiries besides the above common used types can be met on your requirement.

### 5. Material List

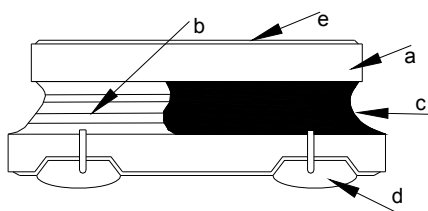

NO	Items	Materials
a	Core	Ferrite Core
b	Wire	Copper Wire
c	Glue	Epoxy with magnetic
d	Solder	Ag/Ni/Sn
e	ink	Halogen-free ketone

### 6. Reliability and Test Condition

Item	Performance	Test Condition
Operating temperature	-40~+125°C (Including self - temperature rise)	
Storage temperature	1. -10~+40°C, 50~60%RH (Product without taping) 2. -40~+125°C (on board)	
<b>Electrical Performance Test</b>		
Inductance	Refer to standard electrical characteristics list.	HP4284A, CH11025, CH3302, CH1320, CH1320S LCR Meter.
DCR		CH16502, Agilent33420A Micro-Ohm Meter.
Saturation Current (Isat)	Approximately ΔL30%	Saturation DC Current (Isat) will cause L0 to drop ΔL(%)
Heat Rated Current (Irms)	Approximately ΔT40°C	Heat Rated Current (Irms) will cause the coil temperature rise ΔT(°C) without core loss. 1. Applied the allowed DC current. 2. Temperature measured by digital surface thermometer
<b>Reliability Test</b>		
Life Test	Appearance : No damage. Inductance : within±10% of initial value Q : Shall not exceed the specification value. RDC : within ±15% of initial value and shall not exceed the specification value	Preconditioning: Run through IR reflow for 2 times.( IPC/JEDEC J-STD-020DClassification Reflow Profiles) Temperature : 125±2°C(Inductor) Applied current : rated current Duration : 1000±12hrs Measured at room temperature after placing for 24±2 hrs
Load Humidity		Preconditioning: Run through IR reflow for 2 times.( IPC/JEDEC J-STD-020DClassification Reflow Profiles) Humidity : 85±2% R.H, Temperature : 85°C±2°C Duration : 1000hrs Min. with 100% rated current Measured at room temperature after placing for 24±2 hrs
Moisture Resistance		Preconditioning: Run through IR reflow for 2 times.( IPC/JEDEC J-STD-020DClassification Reflow Profiles) 1. Baked at 50°C for 25hrs, measured at room temperature after placing for 4 hrs. 2. Raise temperature to 65±2°C 90-100%RH in 2.5hrs, and keep 3 hours, cool down to 25°C in 2.5hrs. 3. Raise temperature to 65±2°C 90-100%RH in 2.5hrs, and keep 3 hours, cool down to 25°C in 2.5hrs,keep at 25°C for 2 hrs then keep at -10°C for 3 hrs 4. Keep at 25°C 80-100%RH for 15min and vibrate at the frequency of 10 to 55 Hz to 10 Hz, measure at room temperature after placing for 1~2 hrs.
Thermal shock		Preconditioning: Run through IR reflow for 2 times.( IPC/JEDEC J-STD-020DClassification Reflow Profiles) Condition for 1 cycle Step1 : -40±2°C 30±5min Step2 : 25±2°C ≤0.5min Step3 : 125±2°C 30±5min Number of cycles : 500 Measured at room temperature after placing for 24±2 hrs
Vibration		Oscillation Frequency: 10 ~ 2K ~ 10Hz for 20 minutes Equipment : Vibration checker Total Amplitude:1.52mm±10% Testing Time : 12 hours(20 minutes, 12 cycles each of 3 orientations).

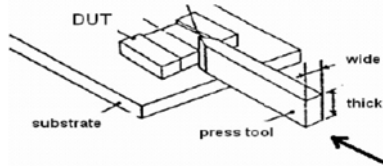
Item	Performance	Test Condition															
Shock	Appearance : No damage. Inductance : within±10% of initial value Q : Shall not exceed the specification value. RDC : within ±15% of initial value and shall not exceed the specification value	<table border="1"> <thead> <tr> <th>Type</th> <th>Peak value (g s)</th> <th>Normal duration (D) (ms)</th> <th>Wave form</th> <th>Velocity change (Vi)ft/sec</th> </tr> </thead> <tbody> <tr> <td>SMD</td> <td>50</td> <td>11</td> <td>Half-sine</td> <td>11.3</td> </tr> <tr> <td>Lead</td> <td>50</td> <td>11</td> <td>Half-sine</td> <td>11.3</td> </tr> </tbody> </table>	Type	Peak value (g s)	Normal duration (D) (ms)	Wave form	Velocity change (Vi)ft/sec	SMD	50	11	Half-sine	11.3	Lead	50	11	Half-sine	11.3
Type	Peak value (g s)	Normal duration (D) (ms)	Wave form	Velocity change (Vi)ft/sec													
SMD	50	11	Half-sine	11.3													
Lead	50	11	Half-sine	11.3													
Bending		Shall be mounted on a FR4 substrate of the following dimensions: >=0805:40x100x1.2mm <0805:40x100x0.8mm Bending depth: >=0805:1.2mm <0805:0.8mm duration of 10 sec.															
Solderability	More than 95% of the terminal electrode should be covered with solder.	Preheat: 150°C, 60sec. Solder: Sn96.5% Ag3% Cu0.5% Temperature: 245±5°C. Flux for lead free: Rosin. 9.5%. Dip time: 4±1sec. Depth: completely cover the termination															
Resistance to Soldering Heat		Number of heat cycles: 1  <table border="1"> <thead> <tr> <th>Temperature (°C)</th> <th>Time(s)</th> <th>Temperature ramp/immersion and emersion rate</th> </tr> </thead> <tbody> <tr> <td>260 ±5(solder temp)</td> <td>10 ±1</td> <td>25mm/s ±6 mm/s</td> </tr> </tbody> </table>	Temperature (°C)	Time(s)	Temperature ramp/immersion and emersion rate	260 ±5(solder temp)	10 ±1	25mm/s ±6 mm/s									
Temperature (°C)	Time(s)	Temperature ramp/immersion and emersion rate															
260 ±5(solder temp)	10 ±1	25mm/s ±6 mm/s															
Terminal Strength	Appearance : No damage. Inductance : within±10% of initial value Q : Shall not exceed the specification value. RDC : within ±15% of initial value and shall not exceed the specification value	Preconditioning: Run through IR reflow for 2 times.( IPC/JEDEC J-STD-020DClassification Reflow Profiles With the component mounted on a PCB with the device to be tested, apply a force (>0805:1kg , <=0805:0.5kg)to the side of a device being tested. This force shall be applied for 60 +1 seconds. Also the force shall be applied gradually as not to apply a shock to the component being tested.  															

Note : When there are questions concerning measurement result : measurement shall be made after 48 ± 2 hours of recovery under the standard condition.

## 7. Soldering and Mounting

### (1) Soldering

Mildly activated rosin fluxes are preferred. The minimum amount of solder can lead to damage from the stresses caused by the difference in coefficients of expansion between solder, chip and substrate. TAI-TECH terminations are suitable for re-flow soldering systems. If hand soldering cannot be avoided, the preferred technique is the utilization of hot air soldering tools.

### (2) Solder re-flow:

Recommended temperature profiles for re-flow soldering in Figure 1.

### (3) Soldering Iron:

Products attachment with a soldering iron is discouraged due to the inherent process control limitations. In the event that a soldering iron must be employed the following precautions are recommended.

- Preheat circuit and products to 150°C
- Never contact the ceramic with the iron tip
- Use a 20 watt soldering iron with tip diameter of 1.0mm
- 355°C tip temperature (max)
- 1.0mm tip diameter (max)
- Limit soldering time to 4~5sec.

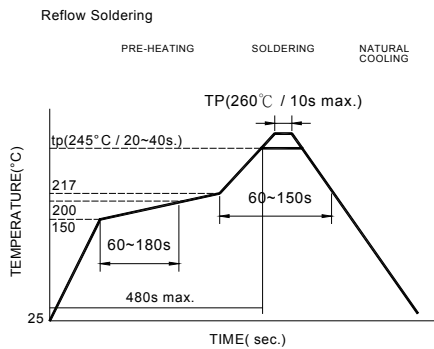

Reflow times: 1 times max.

Fig.1

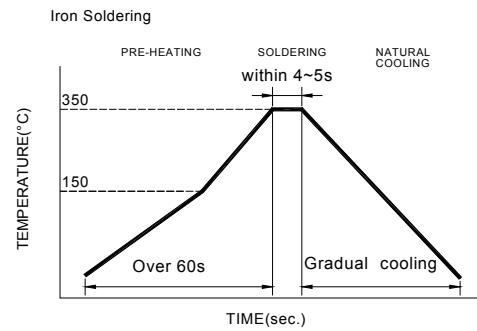

Iron Soldering times: 1 times max.

Fig.2

## 8. Packaging Information

### (1) Reel Dimension

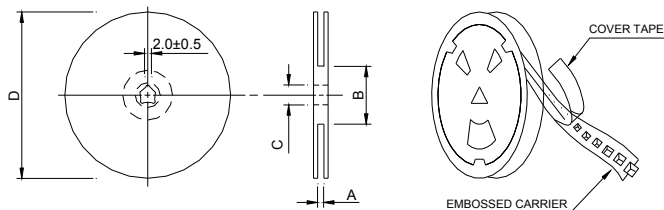

Type	A(mm)	B(mm)	C(mm)	D(mm)
13"x16mm	16.4+2/-0	80±2.0	13+0.5/-0.2	330±3.0

### (2) Tape Dimension

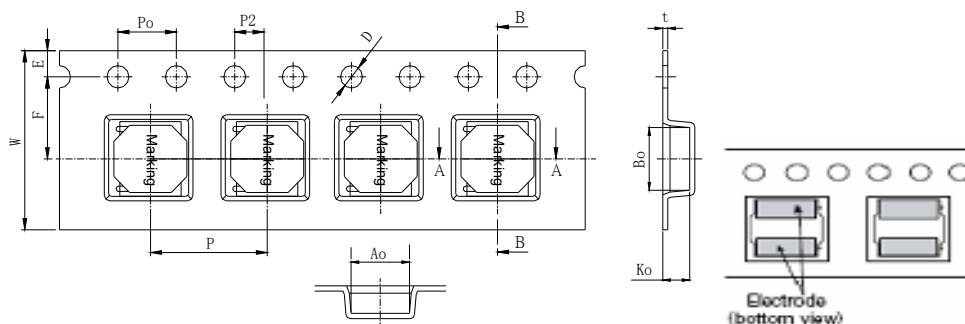

Series	Size	Bo(mm)	Ao(mm)	Ko(mm)	P(mm)	w(mm)	t(mm)	E(mm)	F(mm)	D(mm)	Po(mm)	P2(mm)
HPC	6028	6.4±0.1	6.4±0.1	3.0±0.1	12.0±0.1	16±0.3	0.4±0.1	1.75±0.1	7.5±0.1	1.5±0.1	4.0±0.1	2.00±0.1

### (3) Packaging Quantity

HPC	6028
Reel	1500
Inner box	3000
Carton	12000

### (4) Tearing Off Force

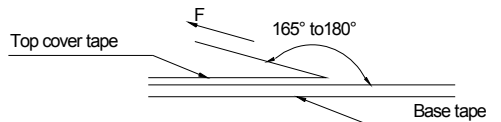

The force for tearing off cover tape is 10 to 130 grams in the arrow direction under the following conditions(referenced ANSI/EIA-481-C-2003 of 4.11 standard).

Room Temp. (°C)	Room Humidity (%)	Room atm (hPa)	Tearing Speed mm/min
5~35	45~85	860~1060	300

#### Application Notice

- Storage Conditions(component level)  
To maintain the solderability of terminal electrodes:
  1. TAI-TECH products meet IPC/JEDEC J-STD-020D standard-MSL, level 1.
  2. Temperature and humidity conditions: Less than 40°C and 60% RH.
  3. Recommended products should be used within 12 months form the time of delivery.
  4. The packaging material should be kept where no chlorine or sulfur exists in the air.
- Transportation
  1. Products should be handled with care to avoid damage or contamination from perspiration and skin oils.
  2. The use of tweezers or vacuum pick up is strongly recommended for individual components.
  3. Bulk handling should ensure that abrasion and mechanical shock are minimized.



### 9. Typical Performance Curves

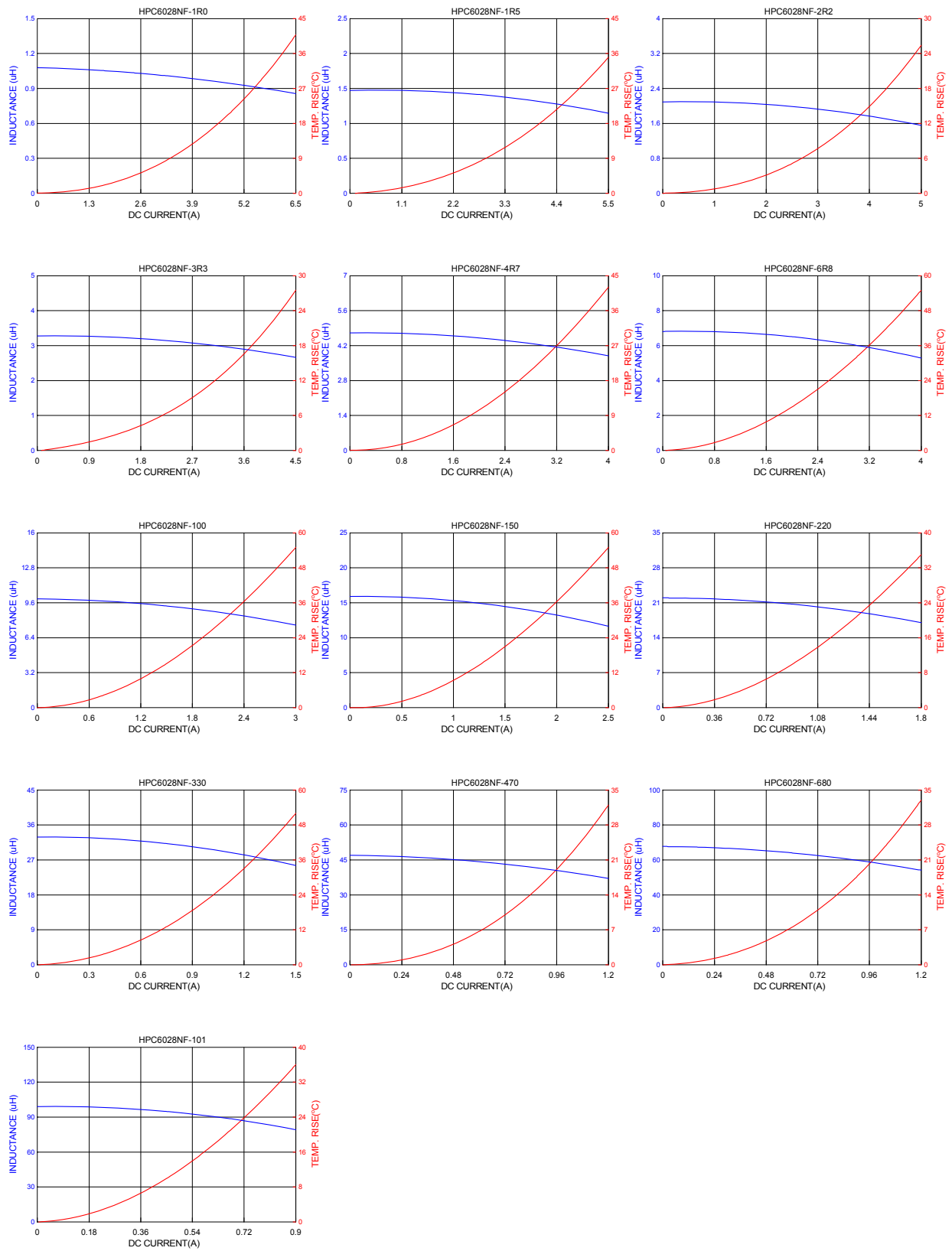

Core chipping

The appearance standard of the chipping size on top side, and bottom side ferrite core is listed below.

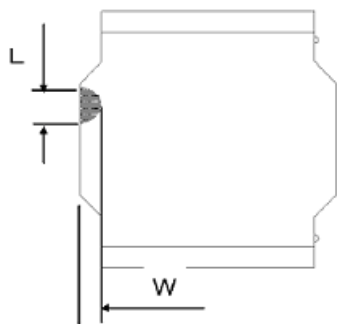

L	W
1.0mm Max.	1.0mm Max.

Void appearance tolerance Limit

Size of voids occurring to coating resin is specified below.

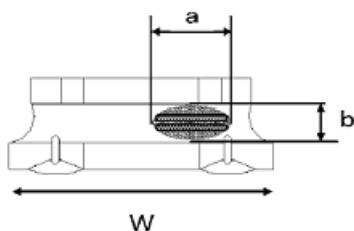

Exposed wire tolerance limit of coating resin part on product side.

Size of exposed wire occurring to coating resin is specified below.

1. Width direction ( dimension a ) : Acceptable when  $a \leq w/2$ .
2. Length direction ( dimension b ) : Dimension b is not specified.
3. The total area of exposed wire occurring to each sides is not greater than 50% of coating resin area, and is acceptable.

External appearance criterion for exposed wire

Exposed end of the winding wire at the secondary side should be 1.5mm and below.

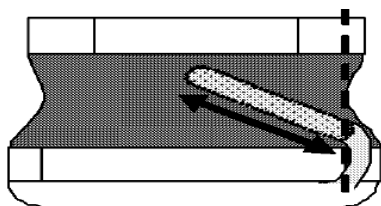

Electrode appearance criterion for exposed wire

Visual check on core surface with no crack means pass.

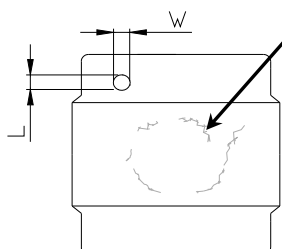

Only top side of wire is exposed.  
(regardless of whole top side of wire exposed)

Conforming

Wire is soldered insufficiently and less than half of outer diameter is covered with solder.

Less than 1/2 of joint side length.  
(More than 1/2 is selected as defect)

L	W
1.0mm Max.	1.0mm Max.

Electrodes with foreign body (dirt) appearance standards  
Foreign materials (dirt) will not affect the coplanarity of PAD,  
below the example of foreign materials (dirt) quantity  $\leq 2$ PCS on single PAD.  
dimension range as below.

## 測試報告 Test Report

號碼(No.) : CE/2015/B1564

日期(Date) : 2015/11/16

頁數(Page): 1 of 15

西北臺慶科技股份有限公司 / TAI-TECH ADVANCED ELECTRONICS CO., LTD.

(臺慶精密電子(昆山)有限公司 / TAI-TECH ADVANCED ELECTRONICS (KUN-SHAN) CO. LTD.)

(耀鑽科技股份有限公司 / YOSONIC TECHNOLOGY CO., LTD.)

(慶邦電子元器件(泗洪)有限公司 / TAIPAQ ELECTRONICS (SI-HONG) CO., LTD.)

桃園市楊梅區幼獅工業區幼四路1號 / NO. 1, YOU 4TH ROAD, YOUTH INDUSTRIAL DISTRICT, YANG-MEI, TAO-YUAN CITY, TAIWAN, R. O. C.

(江蘇省昆山市蓬朗區嘉高科技工業區郭澤路 / GUO-ZE ROAD, KUNJIA HI-TECH INDUSTRIAL PARK, KUN-SHAN, JIANG-SU, CHINA)

(桃園市中壢區中壢工業區長春六路15號 / NO. 15, CHANGCHUN 6TH RD., JHONGLI CITY, TAOYUAN COUNTY 320, TAIWAN)



(江蘇省宿遷市泗洪縣經濟開發區金沙南路-高新技術產業園 / HIGH-TECH INDUSTRIAL DISTRICT, JINSHAJIANG ROAD, SIHONG COUNTY ECONOMIC, SUQIAN CITY, JIANGSU)



以下測試樣品係由申請廠商所提供及確認 (The following sample(s) was/were submitted and identified by/on behalf of the applicant as):

樣品名稱(Sample Description) : SMD POWER INDUCTOR  
樣品型號(Style/Item No.) : HPC(YHC、DR)、MDC、FPC(YPC)、FWP(YWP)、SPC、AHP、UHP、DFP、DHP、TLPC、  
TLPH、TLI SERIES  
收件日期(Sample Receiving Date) : 2015/11/10  
測試期間(Testing Period) : 2015/11/10 TO 2015/11/16

測試結果(Test Results) : 請見下一頁 (Please refer to next pages).

  
  
Troy Chang, Manager - Tech  
Signed for and on behalf of  
SGS TAIWAN LTD.  
Chemical Laboratory - Taipei

This document is issued by the Company subject to its General Conditions of Service printed overleaf, available on request or accessible at <http://www.sgs.com/en/Terms-and-Conditions.aspx> and, for electronic format documents, subject to Terms and Conditions for Electronic Documents at <http://www.sgs.com/en/Terms-and-Conditions/Termse-Document.aspx>. Attention is drawn to the limitation of liability, indemnification and jurisdiction issues defined therein. Any holder of this document is advised that information contained hereon reflects the Company's findings at the time of its intervention only and within the limits of client's instruction, if any. The Company's sole responsibility is to its Client and this document does not exonerate parties to a transaction from exercising all their rights and obligations under the transaction documents. This document cannot be reproduced, except in full, without prior written approval of the Company. Any unauthorized alteration, forgery or falsification of the content or appearance of this document is unlawful and offenders may be prosecuted to the fullest extent of the law. Unless otherwise stated the results shown in this test report refer only to the sample(s) tested.



# 測試報告

## Test Report

號碼(No.) : CE/2015/B1564

日期(Date) : 2015/11/16

頁數(Page): 2 of 15

西北臺慶科技股份有限公司 / TAI-TECH ADVANCED ELECTRONICS CO., LTD.

(臺慶精密電子(昆山)有限公司 / TAI-TECH ADVANCED ELECTRONICS (KUN-SHAN) CO. LTD.)

(耀鑽科技股份有限公司 / YOSONIC TECHNOLOGY CO., LTD.)

(慶邦電子元器件(泗洪)有限公司 / TAIPAQ ELECTRONICS (SI-HONG) CO., LTD.)

桃園市楊梅區幼獅工業區幼四路1號 / NO. 1, YOU 4TH ROAD, YOUTH INDUSTRIAL DISTRICT, YANG-MEI, TAO-YUAN CITY, TAIWAN, R.O.C.

(江蘇省昆山市蓬朗昆嘉高科技工業區郭澤路 / GUO-ZE ROAD, KUNJIA HI-TECH INDUSTRIAL PARK, KUN-SHAN, JIANG-SU, CHINA)

(桃園市中壢區中壢工業區長春六路15號 / NO. 15, CHANGCHUN 6TH RD., JHONGLI CITY, TAOYUAN COUNTY 320, TAIWAN)

(江蘇省宿遷市泗洪縣經濟開發區金沙南路-高新技術產業園 / HIGH-TECH INDUSTRIAL DISTRICT, JINSHAJIANG ROAD, SIHONG COUNTY ECONOMIC, SUQIAN CITY, JIANGSU)



### 測試結果(Test Results)

測試部位(PART NAME)No. 1 : 整體混測 (MIXED ALL PARTS)

測試項目 (Test Items)	單位 (Unit)	測試方法 (Method)	方法偵測 極限值 (MDL)	結果 (Result)
				No. 1
鎘 / Cadmium (Cd)	mg/kg	參考IEC 62321-5: 2013方法, 以感應耦合電漿原子發射光譜儀檢測. / With reference to IEC 62321-5: 2013 and performed by ICP-AES.	2	n. d.
鉛 / Lead (Pb)	mg/kg	參考IEC 62321-5: 2013方法, 以感應耦合電漿原子發射光譜儀檢測. / With reference to IEC 62321-5: 2013 and performed by ICP-AES.	2	n. d.
汞 / Mercury (Hg)	mg/kg	參考IEC 62321-4: 2013方法, 以感應耦合電漿原子發射光譜儀檢測. / With reference to IEC 62321-4: 2013 and performed by ICP-AES.	2	n. d.
六價鉻 / Hexavalent Chromium Cr(VI)	mg/kg	參考IEC 62321: 2008方法, 以UV-VIS檢測. / With reference to IEC 62321: 2008 and performed by UV-VIS.	2	n. d.
六溴環十二烷及所有主要被辨別出的異構物 / Hexabromocyclododecane (HBCDD) and all major diastereoisomers identified ( $\alpha$ -HBCDD, $\beta$ -HBCDD, $\gamma$ -HBCDD) (CAS No.: 25637-99-4 and 3194-55-6 (134237-51-7, 134237-50-6, 134237-52-8))	mg/kg	參考IEC 62321: 2008方法, 以氣相層析/質譜儀檢測. / With reference to IEC 62321: 2008 method. Analysis was performed by GC/MS.	5	n. d.

This document is issued by the Company subject to its General Conditions of Service printed overleaf, available on request or accessible at <http://www.sgs.com/en/Terms-and-Conditions.aspx> and, for electronic format documents, subject to Terms and Conditions for Electronic Documents at <http://www.sgs.com/en/Terms-and-Conditions/Termse-Documents.aspx>. Attention is drawn to the limitation of liability, indemnification and jurisdiction issues defined therein. Any holder of this document is advised that information contained hereon reflects the Company's findings at the time of its intervention only and within the limits of client's instruction, if any. The Company's sole responsibility is to its Client and this document does not exonerate parties to a transaction from exercising all their rights and obligations under the transaction documents. This document cannot be reproduced, except in full, without prior written approval of the Company. Any unauthorized alteration, forgery or falsification of the content or appearance of this document is unlawful and offenders may be prosecuted to the fullest extent of the law. Unless otherwise stated the results shown in this test report refer only to the sample(s) tested.



# 測試報告 Test Report

號碼(No.) : CE/2015/B1564

日期(Date) : 2015/11/16

頁數(Page): 3 of 15

西北臺慶科技股份有限公司 / TAI-TECH ADVANCED ELECTRONICS CO., LTD.



(臺慶精密電子(昆山)有限公司 / TAI-TECH ADVANCED ELECTRONICS (KUN-SHAN) CO. LTD.)

(耀鑽科技股份有限公司 / YOSONIC TECHNOLOGY CO., LTD.)

(慶邦電子元器件(泗洪)有限公司 / TAIPAQ ELECTRONICS (SI-HONG) CO., LTD.)

桃園市楊梅區幼獅工業區幼四路1號 / NO. 1, YOU 4TH ROAD, YOUTH INDUSTRIAL DISTRICT, YANG-MEI, TAO-YUAN CITY, TAIWAN, R.O.C.

(江蘇省昆山市蓬朗昆嘉高科技工業區郭澤路 / GUO-ZE ROAD, KUNJIA HI-TECH INDUSTRIAL PARK, KUN-SHAN, JIANG-SU, CHINA)

(桃園市中壢區中壢工業區長春六路15號 / NO. 15, CHANGCHUN 6TH RD., JHONGLI CITY, TAOYUAN COUNTY 320, TAIWAN)

(江蘇省宿遷市泗洪縣經濟開發區金沙南路-高新技術產業園 / HIGH-TECH INDUSTRIAL DISTRICT, JINSHAJIANG ROAD, SIHONG COUNTY ECONOMIC, SUQIAN CITY, JIANGSU)

測試項目 (Test Items)	單位 (Unit)	測試方法 (Method)	方法偵測 極限值 (MDL)	結果 (Result)
				No. 1
聚氯乙稀 / PVC	**	以紅外光譜分析及焰色法檢測。 / Analysis was performed by FTIR and FLAME Test.	-	Negative
多溴聯苯總和 / Sum of PBBs	mg/kg	參考IEC 62321-6: 2015方法, 以氣相層析/質譜儀檢測。 / With reference to IEC 62321-6: 2015 and performed by GC/MS.	-	n. d.
一溴聯苯 / Monobromobiphenyl	mg/kg		5	n. d.
二溴聯苯 / Dibromobiphenyl	mg/kg		5	n. d.
三溴聯苯 / Tribromobiphenyl	mg/kg		5	n. d.
四溴聯苯 / Tetrabromobiphenyl	mg/kg		5	n. d.
五溴聯苯 / Pentabromobiphenyl	mg/kg		5	n. d.
六溴聯苯 / Hexabromobiphenyl	mg/kg		5	n. d.
七溴聯苯 / Heptabromobiphenyl	mg/kg		5	n. d.
八溴聯苯 / Octabromobiphenyl	mg/kg		5	n. d.
九溴聯苯 / Nonabromobiphenyl	mg/kg		5	n. d.
十溴聯苯 / Decabromobiphenyl	mg/kg		5	n. d.
多溴聯苯醚總和 / Sum of PBDEs	mg/kg		-	n. d.
一溴聯苯醚 / Monobromodiphenyl ether	mg/kg		5	n. d.
二溴聯苯醚 / Dibromodiphenyl ether	mg/kg		5	n. d.
三溴聯苯醚 / Tribromodiphenyl ether	mg/kg		5	n. d.
四溴聯苯醚 / Tetrabromodiphenyl ether	mg/kg		5	n. d.
五溴聯苯醚 / Pentabromodiphenyl ether	mg/kg		5	n. d.
六溴聯苯醚 / Hexabromodiphenyl ether	mg/kg		5	n. d.
七溴聯苯醚 / Heptabromodiphenyl ether	mg/kg		5	n. d.
八溴聯苯醚 / Octabromodiphenyl ether	mg/kg		5	n. d.
九溴聯苯醚 / Nonabromodiphenyl ether	mg/kg	5	n. d.	
十溴聯苯醚 / Decabromodiphenyl ether	mg/kg	5	n. d.	

This document is issued by the Company subject to its General Conditions of Service printed overleaf, available on request or accessible at <http://www.sgs.com/en/Terms-and-Conditions.aspx> and, for electronic format documents, subject to Terms and Conditions of Electronic Documents at <http://www.sgs.com/en/Terms-and-Conditions/Electronic-Documents.aspx>. Attention is drawn to the limitation of liability, indemnification and jurisdiction issues defined therein. Any holder of this document is advised that information contained hereon reflects the Company's findings at the time of its intervention only and within the limits of client's instruction, if any. The Company's sole responsibility is to its Client and this document does not exonerate parties to a transaction from exercising all their rights and obligations under the transaction documents. This document cannot be reproduced, except in full, without prior written approval of the Company. Any unauthorized alteration, forgery or falsification of the content or appearance of this document is unlawful and offenders may be prosecuted to the fullest extent of the law. Unless otherwise stated the results shown in this test report refer only to the sample(s) tested.



# 測試報告

## Test Report

號碼(No.) : CE/2015/B1564

日期(Date) : 2015/11/16

頁數(Page): 4 of 15

西北臺慶科技股份有限公司 / TAI-TECH ADVANCED ELECTRONICS CO., LTD.

(臺慶精密電子(昆山)有限公司 / TAI-TECH ADVANCED ELECTRONICS (KUN-SHAN) CO. LTD.)

(耀鑽科技股份有限公司 / YOSONIC TECHNOLOGY CO., LTD.)

(慶邦電子元器件(泗洪)有限公司 / TAIPAQ ELECTRONICS (SI-HONG) CO., LTD.)

桃園市楊梅區幼獅工業區幼四路1號 / NO. 1, YOU 4TH ROAD, YOUTH INDUSTRIAL DISTRICT, YANG-MEI, TAO-YUAN CITY, TAIWAN, R.O.C.

(江蘇省昆山市蓬朗區高科技工業區郭澤路 / GUO-ZE ROAD, KUNJIA HI-TECH INDUSTRIAL PARK, KUN-SHAN, JIANG-SU, CHINA)

(桃園市中壢區中壢工業區長春六路15號 / NO. 15, CHANGCHUN 6TH RD., JHONGLI CITY, TAOYUAN COUNTY 320, TAIWAN)

(江蘇省宿遷市泗洪縣經濟開發區金沙南路-高新技術產業園 / HIGH-TECH INDUSTRIAL DISTRICT, JINSHAJIANG ROAD, SIHONG COUNTY ECONOMIC, SUQIAN CITY, JIANGSU)



測試項目 (Test Items)	單位 (Unit)	測試方法 (Method)	方法偵測 極限值 (MDL)	結果 (Result)
				No.1
銻 / Antimony (Sb)	mg/kg	參考US EPA 3052方法, 以感應耦合電漿原子發射光譜儀檢測. / With reference to US EPA Method 3052. Analysis was performed by ICP-AES.	2	n. d.
鈹 / Beryllium (Be)	mg/kg	參考US EPA 3052方法, 以感應耦合電漿原子發射光譜儀檢測. / With reference to US EPA Method 3052. Analysis was performed by ICP-AES.	2	n. d.
全氟辛烷磺酸 / Perfluorooctane sulfonates (PFOS-Acid, Metal Salt, Amide)	mg/kg	參考US EPA 3550C: 2007方法, 以液相層析 / 質譜儀檢測. / With reference to US EPA 3550C: 2007. Analysis was performed by LC/MS.	10	n. d.
全氟辛酸 / PFOA (CAS No. : 335-67-1)	mg/kg	參考US EPA 3550C: 2007方法, 以液相層析 / 質譜儀檢測. / With reference to US EPA 3550C: 2007. Analysis was performed by LC/MS.	10	n. d.
鹵素 / Halogen				
鹵素(氟) / Halogen-Fluorine (F) (CAS No. : 14762-94-8)	mg/kg	參考BS EN 14582:2007, 以離子層析儀分析. / With reference to BS EN 14582:2007. Analysis was performed by IC.	50	n. d.
鹵素(氯) / Halogen-Chlorine (Cl) (CAS No. : 22537-15-1)	mg/kg		50	n. d.
鹵素(溴) / Halogen-Bromine (Br) (CAS No. : 10097-32-2)	mg/kg		50	n. d.
鹵素(碘) / Halogen-Iodine (I) (CAS No. : 14362-44-8)	mg/kg		50	n. d.

This document is issued by the Company subject to its General Conditions of Service printed overleaf, available on request or accessible at <http://www.sgs.com/en/Terms-and-Conditions.aspx> and, for electronic format documents, subject to Terms and Conditions for Electronic Documents at <http://www.sgs.com/en/Terms-and-Conditions/Terms-Electronic-Documents.aspx>. Attention is drawn to the limitation of liability, indemnification and jurisdiction issues defined therein. Any holder of this document is advised that information contained hereon reflects the Company's findings at the time of its intervention only and within the limits of client's instruction, if any. The Company's sole responsibility is to its Client and this document does not exonerate parties to a transaction from exercising all their rights and obligations under the transaction documents. This document cannot be reproduced, except in full, without prior written approval of the Company. Any unauthorized alteration, forgery or falsification of the content or appearance of this document is unlawful and offenders may be prosecuted to the fullest extent of the law. Unless otherwise stated the results shown in this test report refer only to the sample(s) tested.



# 測試報告

## Test Report

號碼(No.) : CE/2015/B1564

日期(Date) : 2015/11/16

頁數(Page): 5 of 15

西北臺慶科技股份有限公司 / TAI-TECH ADVANCED ELECTRONICS CO., LTD.

(臺慶精密電子(昆山)有限公司 / TAI-TECH ADVANCED ELECTRONICS (KUN-SHAN) CO. LTD.)

(耀鑽科技股份有限公司 / YOSONIC TECHNOLOGY CO., LTD.)

(慶邦電子元器件(泗洪)有限公司 / TAIPAQ ELECTRONICS (SI-HONG) CO., LTD.)

桃園市楊梅區幼獅工業區幼四路1號 / NO. 1, YOU 4TH ROAD, YOUTH INDUSTRIAL DISTRICT, YANG-MEI, TAO-YUAN CITY, TAIWAN, R. O. C.

(江蘇省昆山市蓬朗區嘉高科技工業區郭澤路 / GUO-ZE ROAD, KUNJIA HI-TECH INDUSTRIAL PARK, KUN-SHAN, JIANG-SU, CHINA)

(桃園市中壢區中壢工業區長春六路15號 / NO. 15, CHANGCHUN 6TH RD., JHONGLI CITY, TAOYUAN COUNTY 320, TAIWAN)

(江蘇省宿遷市泗洪縣經濟開發區金沙南路-高新技術產業園 / HIGH-TECH INDUSTRIAL DISTRICT, JINSHAJIANG ROAD, SIHONG COUNTY ECONOMIC, SUQIAN CITY, JIANGSU)



測試項目 (Test Items)	單位 (Unit)	測試方法 (Method)	方法偵測 極限值 (MDL)	結果 (Result)
				No. 1
鄰苯二甲酸丁苯甲酯 / BBP (Butyl Benzyl phthalate) (CAS No. : 85-68-7)	mg/kg	參考 IEC 62321-8 (111/321/CD) , 以氣相層析儀/質譜儀檢測之。 / With reference to IEC 62321-8 (111/321/CD). Analysis was performed by GC/MS.	50	n. d.
鄰苯二甲酸二丁酯 / DBP (Dibutyl phthalate) (CAS No. : 84-74-2)	mg/kg		50	n. d.
鄰苯二甲酸二(2-乙基己基)酯 / DEHP (Di-(2-ethylhexyl) phthalate) (CAS No. : 117-81-7)	mg/kg		50	n. d.
鄰苯二甲酸二異丁酯 / DIBP (Di-isobutyl phthalate) (CAS No. : 84-69-5)	mg/kg		50	n. d.
鄰苯二甲酸二異癸酯 / DIDP (Di-isodecyl phthalate) (CAS No. : 26761-40-0; 68515-49-1)	mg/kg		50	n. d.
鄰苯二甲酸二異壬酯 / DINP (Di-isononyl phthalate) (CAS No. : 28553-12-0; 68515-48-0)	mg/kg		50	n. d.
鄰苯二甲酸二正辛酯 / DNOP (Di-n-octyl phthalate) (CAS No. : 117-84-0)	mg/kg		50	n. d.
鄰苯二甲酸二正己酯 / DNHP (Di-n-hexyl phthalate) (CAS No. : 84-75-3)	mg/kg		50	n. d.

This document is issued by the Company subject to its General Conditions of Service printed overleaf, available on request or accessible at <http://www.sgs.com/en/Terms-and-Conditions.aspx> and, for electronic format documents, subject to Terms and Conditions for Electronic Documents at <http://www.sgs.com/en/Terms-and-Conditions/Termse-LicenceDocument.aspx>. Attention is drawn to the limitation of liability, indemnification and jurisdiction issues defined therein. Any holder of this document is advised that information contained hereon reflects the Company's findings at the time of its intervention only and within the limits of client's instruction, if any. The Company's sole responsibility is to its Client and this document does not exonerate parties to a transaction from exercising all their rights and obligations under the transaction documents. This document cannot be reproduced, except in full, without prior written approval of the Company. Any unauthorized alteration, forgery or falsification of the content or appearance of this document is unlawful and offenders may be prosecuted to the fullest extent of the law. Unless otherwise stated the results shown in this test report refer only to the sample(s) tested.



## 測試報告

## Test Report

號碼(No.) : CE/2015/BI564

日期(Date) : 2015/11/16

頁數(Page): 6 of 15

西北臺慶科技股份有限公司 / TAI-TECH ADVANCED ELECTRONICS CO., LTD.

(臺慶精密電子(昆山)有限公司 / TAI-TECH ADVANCED ELECTRONICS (KUN-SHAN) CO. LTD.)

(耀鑽科技股份有限公司 / YOSONIC TECHNOLOGY CO., LTD.)

(慶邦電子元器件(泗洪)有限公司 / TAIPAQ ELECTRONICS (SI-HONG) CO., LTD.)

桃園市楊梅區幼獅工業區幼四路1號 / NO. 1, YOU 4TH ROAD, YOUTH INDUSTRIAL DISTRICT, YANG-MEI, TAO-YUAN CITY, TAIWAN, R. O. C.

(江蘇省昆山市蓬朗昆嘉高科技工業區郭澤路 / GUO-ZE ROAD, KUNJIA HI-TECH INDUSTRIAL PARK, KUN-SHAN, JIANG-SU, CHINA)

(桃園市中壢區中壢工業區長春六路15號 / NO. 15, CHANGCHUN 6TH RD.; JHONGLI CITY, TAOYUAN COUNTY 320, TAIWAN)

(江蘇省宿遷市泗洪縣經濟開發區金沙南路-高新技術產業園 / HIGH-TECH INDUSTRIAL DISTRICT, JINSHAJIANG ROAD, SIHONG COUNTY ECONOMIC, SUQIAN CITY, JIANGSU)



### 備註(Note) :

1. mg/kg = ppm ; 0.1wt% = 1000ppm
2. n. d. = Not Detected (未檢出)
3. MDL = Method Detection Limit (方法偵測極限值)
4. "-" = Not Regulated (無規格值)
5. \*\*= Qualitative analysis (No Unit) 定性分析(無單位)
6. Negative = Undetectable 陰性(未偵測到); Positive = Detectable 陽性(已偵測到)
7. 樣品的測試是基於申請人要求混合測試, 報告中的混合測試結果不代表其中個別單一材質的含量. (The samples was/were analyzed on behalf of the applicant as mixing sample in one testing. The above results was/were only given as the informality value.)

### PFOS參考資訊(Reference Information) : 持久性有機污染物 POPs - (EU) 757/2010

PFOS濃度在物質或製備中不得超過0.001%(10ppm), 在半成品、成品或零部件中不得超過0.1%(1000ppm), 在紡織品或塗層材料中不得超過 $1\mu\text{g}/\text{m}^2$ 。

(Outlawing PFOS as substances or preparations in concentrations above 0.001% (10ppm), in semi-finished products or articles or parts at a level above 0.1%(1000ppm), in textiles or other coated materials above  $1\mu\text{g}/\text{m}^2$ .)

This document is issued by the Company subject to its General Conditions of Service printed overleaf, available on request or accessible at <http://www.sgs.com/en/Terms-and-Conditions.aspx> and, for electronic format documents, subject to Terms and Conditions for Electronic Documents at <http://www.sgs.com/en/Terms-and-Conditions/Terms-Electronic-Documents.aspx>. Attention is drawn to the limitation of liability, indemnification and jurisdiction issues defined therein. Any holder of this document is advised that information contained hereon reflects the Company's findings at the time of its intervention only and within the limits of client's instruction, if any. The Company's sole responsibility is to its Client and this document does not exonerate parties to a transaction from exercising all their rights and obligations under the transaction documents. This document cannot be reproduced, except in full, without prior written approval of the Company. Any unauthorized alteration, forgery or falsification of the content or appearance of this document is unlawful and offenders may be prosecuted to the fullest extent of the law. Unless otherwise stated the results shown in this test report refer only to the sample(s) tested.





# 測試報告 Test Report

號碼(No.): CE/2015/B1564

日期(Date): 2015/11/16

頁數(Page): 7 of 15

西北臺慶科技股份有限公司 / TAI-TECH ADVANCED ELECTRONICS CO., LTD.

(臺慶精密電子(昆山)有限公司 / TAI-TECH ADVANCED ELECTRONICS (KUN-SHAN) CO. LTD.)

(耀鑽科技股份有限公司 / YOSONIC TECHNOLOGY CO., LTD.)

(慶邦電子元器件(泗洪)有限公司 / TAIPAQ ELECTRONICS (SI-HONG) CO., LTD.)

桃園市楊梅區幼獅工業區幼四路1號 / NO. 1, YOU 4TH ROAD, YOUTH INDUSTRIAL DISTRICT, YANG-MEI, TAO-YUAN CITY, TAIWAN, R.O.C.

(江蘇省昆山市蓬朗區高科技工業區郭澤路 / GUO-ZE ROAD, KUNJIA HI-TECH INDUSTRIAL PARK, KUN-SHAN, JIANG-SU, CHINA)

(桃園市中壢區中壢工業區長春六路15號 / NO. 15, CHANGCHUN 6TH RD., JHONGLI CITY, TAOYUAN COUNTY 320, TAIWAN)

(江蘇省宿遷市泗洪縣經濟開發區金沙南路-高新技術產業園 / HIGH-TECH INDUSTRIAL DISTRICT, JINSHAJIANG ROAD, SIHONG COUNTY ECONOMIC, SUQIAN CITY, JIANGSU)



- 1) 根據以下的流程圖之條件，樣品已完全溶解。(六價鉻測試方法除外) / These samples were dissolved totally by pre-conditioning method according to below flow chart. (Cr<sup>6+</sup> test method excluded)
- 2) 測試人員: 楊登偉 / Name of the person who made measurement: Climbgreat Yang
- 3) 測試負責人: 張啟興 / Name of the person in charge of measurement: Troy Chang

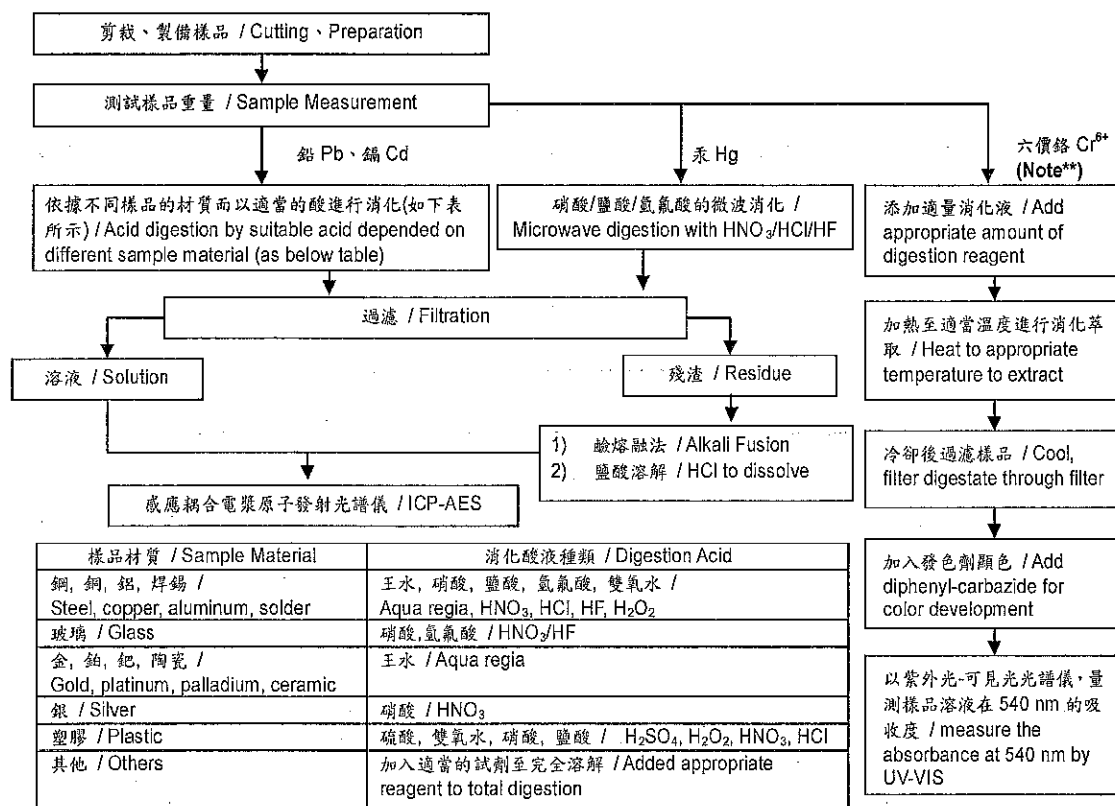

### Note: (For IEG-62321)

- (1) 針對非金屬材料加入鹼性消化液，加熱至 90~95°C 萃取。 / For non-metallic material, add alkaline digestion reagent and heat to 90~95°C.
- (2) 針對金屬材料加入純水，加熱至沸騰萃取。 / For metallic material, add pure water and heat to boiling.

This document is issued by the Company subject to its General Conditions of Service printed overleaf, available on request or accessible at <http://www.sgs.com/en/Terms-and-Conditions.aspx> and, for electronic format documents, subject to Terms and Conditions for Electronic Documents at <http://www.sgs.com/en/Terms-and-Conditions/Terms-and-Conditions.aspx>. Attention is drawn to the limitation of liability, indemnification and jurisdiction issues defined therein. Any holder of this document is advised that information contained hereon reflects the Company's findings at the time of its intervention only and within the limits of client's instruction, if any. The Company's sole responsibility is to its Client and this document does not exonerate parties to a transaction from exercising all their rights and obligations under the transaction documents. This document cannot be reproduced, except in full, without prior written approval of the Company. Any unauthorized alteration, forgery or falsification of the content or appearance of this document is unlawful and offenders may be prosecuted to the fullest extent of the law. Unless otherwise stated the results shown in this test report refer only to the sample(s) tested.



# 測試報告 Test Report

號碼(No.) : CE/2015/B1564

日期(Date) : 2015/11/16

頁數(Page): 8 of 15

西北臺慶科技股份有限公司 / TAI-TECH ADVANCED ELECTRONICS CO., LTD.

(臺慶精密電子(昆山)有限公司 / TAI-TECH ADVANCED ELECTRONICS (KUN-SHAN) CO. LTD.)

(耀鑽科技股份有限公司 / YOSONIC TECHNOLOGY CO., LTD.)

(慶邦電子元器件(泗洪)有限公司 / TAIPAQ ELECTRONICS (SI-HONG) CO., LTD.)

桃園市楊梅區幼獅工業區幼四路1號 / NO. 1, YOU 4TH ROAD, YOUTH INDUSTRIAL DISTRICT, YANG-MEI, TAO-YUAN CITY, TAIWAN, R.O.C.

(江蘇省昆山市蓬朗區嘉高科技工業區郭澤路 / GUO-ZE ROAD, KUNJIA HI-TECH INDUSTRIAL PARK, KUN-SHAN, JIANG-SU, CHINA)

(桃園市中壢區中壢工業區長春六路15號 / NO. 15, CHANGCHUN 6TH RD., JHONGLI CITY, TAOYUAN COUNTY 320, TAIWAN)

(江蘇省宿遷市泗洪縣經濟開發區金沙南路-高新技術產業園 / HIGH-TECH INDUSTRIAL DISTRICT, JINSHAJIANG ROAD, SIHONG COUNTY ECONOMIC, SUQIAN CITY, JIANGSU)



## 全氟辛酸/全氟辛烷磺酸分析流程圖 / PFOA/PFOS analytical flow chart

- 測試人員：翁賜彬 / Name of the person who made measurement: Roman Wong
- 測試負責人：張啟興 / Name of the person in charge of measurement: Troy Chang

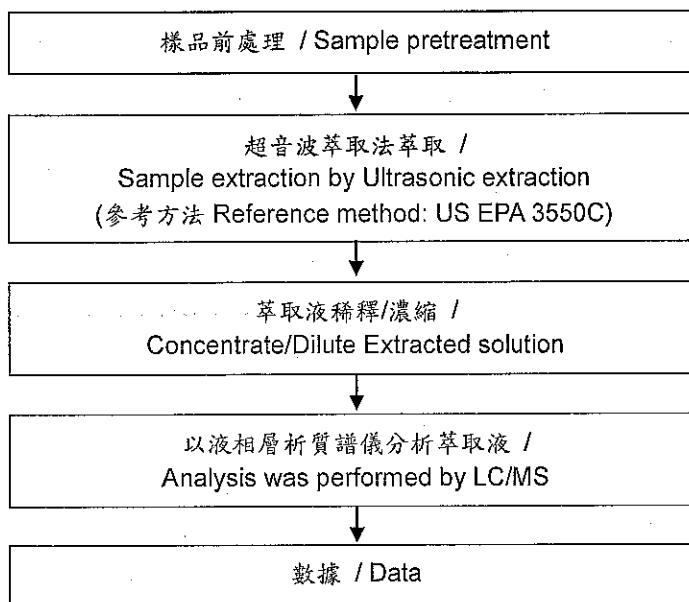

This document is issued by the Company subject to its General Conditions of Service printed overleaf, available on request or accessible at <http://www.sgs.com/en/terms-and-conditions.aspx> and, for electronic format documents, subject to Terms and Conditions for Electronic Documents at <http://www.sgs.com/en/terms-and-conditions/terms-and-conditions-for-electronic-document.aspx>. Attention is drawn to the limitation of liability, indemnification and jurisdiction issues defined therein. Any holder of this document is advised that information contained hereon reflects the Company's findings at the time of its intervention only and within the limits of client's instruction, if any. The Company's sole responsibility is to its Client and this document does not exonerate parties to a transaction from exercising all their rights and obligations under the transaction documents. This document cannot be reproduced, except in full, without prior written approval of the Company. Any unauthorized alteration, forgery or falsification of the content or appearance of this document is unlawful and offenders may be prosecuted to the fullest extent of the law. Unless otherwise stated the results shown in this test report refer only to the sample(s) tested.



# 測試報告 Test Report

號碼(No.) : CE/2015/B1564

日期(Date) : 2015/11/16

頁數(Page): 9 of 15

西北臺慶科技股份有限公司 / TAI-TECH ADVANCED ELECTRONICS CO., LTD.

(臺慶精密電子(昆山)有限公司 / TAI-TECH ADVANCED ELECTRONICS (KUN-SHAN) CO. LTD.)

(耀鑽科技股份有限公司 / YOSONIC TECHNOLOGY CO., LTD.)

(慶邦電子元器件(泗洪)有限公司 / TAIPAQ ELECTRONICS (SI-HONG) CO., LTD.)

桃園市楊梅區幼獅工業區幼四路1號 / NO. 1, YOU 4TH ROAD, YOUTH INDUSTRIAL DISTRICT, YANG-MEI, TAO-YUAN CITY, TAIWAN, R.O.C.

(江蘇省昆山市蓬朗區嘉高科技工業區郭澤路 / GUO-ZE ROAD, KUNJIA HI-TECH INDUSTRIAL PARK, KUN-SHAN, JIANG-SU, CHINA)

(桃園市中壢區中壢工業區長春六路15號 / NO. 15, CHANGCHUN 6TH RD., JHONGLI CITY, TAOYUAN COUNTY 320, TAIWAN)

(江蘇省宿遷市泗洪縣經濟開發區金沙南路-高新技術產業園 / HIGH-TECH INDUSTRIAL DISTRICT, JINSHAJIANG ROAD, SIHONG COUNTY ECONOMIC, SUQIAN CITY, JIANGSU)

- 根據以下的流程圖之條件，樣品已完全溶解。 / These samples were dissolved totally by pre-conditioning method according to below flow chart.
- 測試人員：楊登偉 / Name of the person who made measurement: Climbgreat Yang
- 測試負責人：張啟興 / Name of the person in charge of measurement: Troy Chang

元素以 ICP-AES 分析的消化流程圖  
(Flow Chart of digestion for the elements analysis performed by ICP-AES)

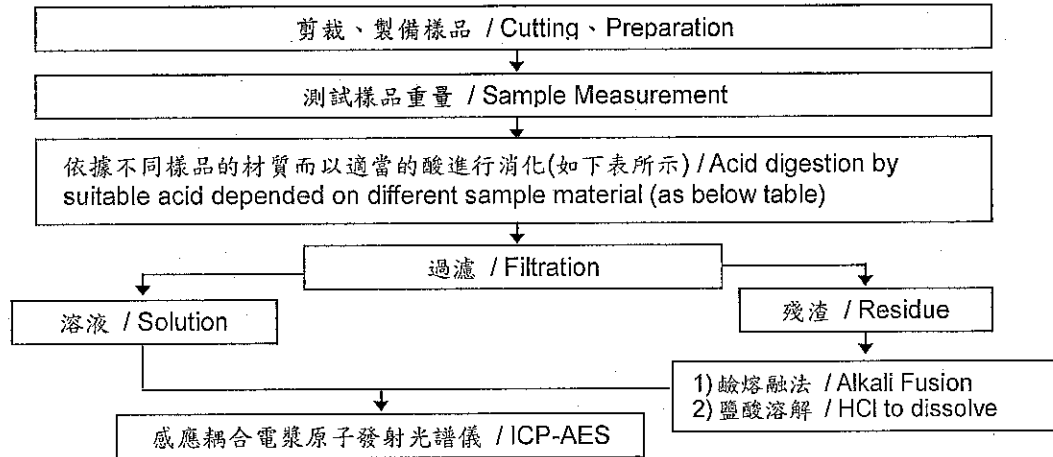

鋼,銅,鋁,焊錫 / Steel, copper, aluminum, solder	王水,硝酸,鹽酸,氫氟酸,雙氧水 / Aqua regia, HNO <sub>3</sub> , HCl, HF, H <sub>2</sub> O <sub>2</sub>
玻璃 / Glass	硝酸,氫氟酸 / HNO <sub>3</sub> /HF
金,鉑,鈀,陶瓷 / Gold, platinum, palladium, ceramic	王水 / Aqua regia
銀 / Silver	硝酸 / HNO <sub>3</sub>
塑膠 / Plastic	硫酸,雙氧水,硝酸,鹽酸 / H <sub>2</sub> SO <sub>4</sub> , H <sub>2</sub> O <sub>2</sub> , HNO <sub>3</sub> , HCl
其他 / Others	加入適當的試劑至完全溶解 / Added appropriate reagent to total digestion

This document is issued by the Company subject to its General Conditions of Service printed overleaf, available on request or accessible at <http://www.sgs.com/en/Terms-and-Conditions.aspx> and, for electronic format documents, subject to Terms and Conditions for Electronic Documents at <http://www.sgs.com/en/Terms-and-Conditions/Terms-Document.aspx>. Attention is drawn to the limitation of liability, indemnification and jurisdiction issues defined therein. Any holder of this document is advised that information contained hereon reflects the Company's findings at the time of its intervention only and within the limits of client's instruction, if any. The Company's sole responsibility is to its Client and this document does not exonerate parties to a transaction from exercising all their rights and obligations under the transaction documents. This document cannot be reproduced, except in full, without prior written approval of the Company. Any unauthorized alteration, forgery or falsification of the content or appearance of this document is unlawful and offenders may be prosecuted to the fullest extent of the law. Unless otherwise stated the results shown in this test report refer only to the sample(s) tested.



# 測試報告 Test Report

號碼(No.) : CE/2015/B1564

日期(Date) : 2015/11/16

頁數(Page): 10 of 15

西北臺慶科技股份有限公司 / TAI-TECH ADVANCED ELECTRONICS CO., LTD.

(臺慶精密電子(昆山)有限公司 / TAI-TECH ADVANCED ELECTRONICS (KUN-SHAN) CO. LTD.)

(耀鑽科技股份有限公司 / YOSONIC TECHNOLOGY CO., LTD.)

(慶邦電子元器件(泗洪)有限公司 / TAIPAQ ELECTRONICS (SI-HONG) CO., LTD.)

桃園市楊梅區幼獅工業區幼四路1號 / NO. 1, YOU 4TH ROAD, YOUTH INDUSTRIAL DISTRICT, YANG-MEI, TAO-YUAN CITY, TAIWAN, R.O.C.

(江蘇省昆山市蓬朗昆嘉高科技工業區郭澤路 / GUO-ZE ROAD, KUNJIA HI-TECH INDUSTRIAL PARK, KUN-SHAN, JIANG-SU, CHINA)

(桃園市中壢區中壢工業區長春六路15號 / NO. 15, CHANGCHUN 6TH RD., JHONGLI CITY, TAOYUAN COUNTY 320, TAIWAN)

(江蘇省宿遷市泗洪縣經濟開發區金沙南路-高新技術產業園 / HIGH-TECH INDUSTRIAL DISTRICT, JINSHAJIANG ROAD, SIHONG COUNTY ECONOMIC, SUQIAN CITY, JIANGSU)



## 聚氯乙稀物質判定分析流程圖 /

### Analysis flow chart for determination of PVC in material

- 測試人員：林建宇 / Name of the person who made measurement: Roy Lin
- 測試負責人：張啟興 / Name of the person in charge of measurement: Troy Chang

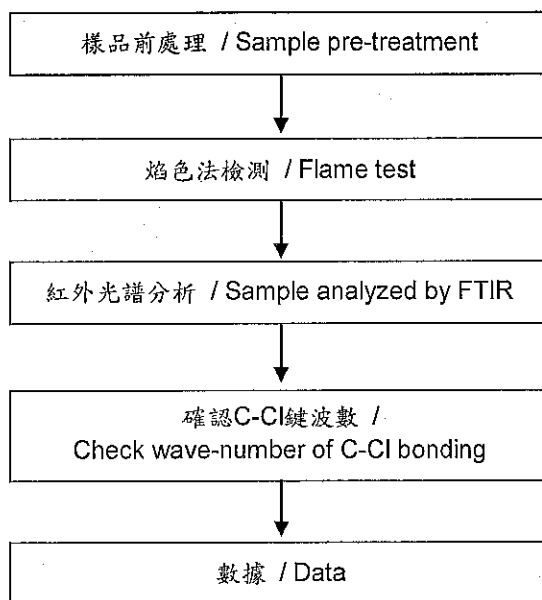

This document is issued by the Company subject to its General Conditions of Service printed overleaf, available on request or accessible at <http://www.sgs.com/ver/terms-and-conditions.aspx> and, for electronic format documents, subject to Terms and Conditions for Electronic Documents at <http://www.sgs.com/ver/terms-and-conditions/terms-and-conditions.aspx>. Attention is drawn to the limitation of liability, indemnification and jurisdiction issues defined therein. Any holder of this document is advised that information contained hereon reflects the Company's findings at the time of its intervention only and within the limits of client's instruction, if any. The Company's sole responsibility is to its Client and this document does not exonerate parties to a transaction from exercising all their rights and obligations under the transaction documents. This document cannot be reproduced, except in full, without prior written approval of the Company. Any unauthorized alteration, forgery or falsification of the content or appearance of this document is unlawful and offenders may be prosecuted to the fullest extent of the law. Unless otherwise stated the results shown in this test report refer only to the sample(s) tested.



# 測試報告 Test Report

號碼(No.) : CE/2015/B1564

日期(Date) : 2015/11/16

頁數(Page): 11 of 15

西北臺慶科技股份有限公司 / TAI-TECH ADVANCED ELECTRONICS CO., LTD.

(臺慶精密電子(昆山)有限公司 / TAI-TECH ADVANCED ELECTRONICS (KUN-SHAN) CO. LTD.)

(耀鑽科技股份有限公司 / YOSONIC TECHNOLOGY CO., LTD.)

(慶邦電子元件(泗洪)有限公司 / TAIPAQ ELECTRONICS (SI-HONG) CO., LTD.)

桃園市楊梅區幼獅工業區幼四路1號 / NO. 1, YOU 4TH ROAD, YOUTH INDUSTRIAL DISTRICT, YANG-MEI, TAO-YUAN CITY, TAIWAN, R. O. C.

(江蘇省昆山市蓬朗區高科技工業區郭澤路 / GUO-ZE ROAD, KUNJIA HI-TECH INDUSTRIAL PARK, KUN-SHAN, JIANG-SU, CHINA)

(桃園市中壢區中壢工業區長春六路15號 / NO. 15, CHANGCHUN 6TH RD., JHONGLI CITY, TAOYUAN COUNTY 320, TAIWAN)

(江蘇省宿遷市泗洪縣經濟開發區金沙南路-高新技術產業園 / HIGH-TECH INDUSTRIAL DISTRICT, JINSHAJIANG ROAD, SIHONG COUNTY ECONOMIC, SUQIAN CITY, JIANGSU)



## 鹵素分析流程圖 / Analytical flow chart of halogen content

- 測試人員：陳恩臻 / Name of the person who made measurement: Rita Chen
- 測試負責人：張啟興 / Name of the person in charge of measurement: Troy Chang

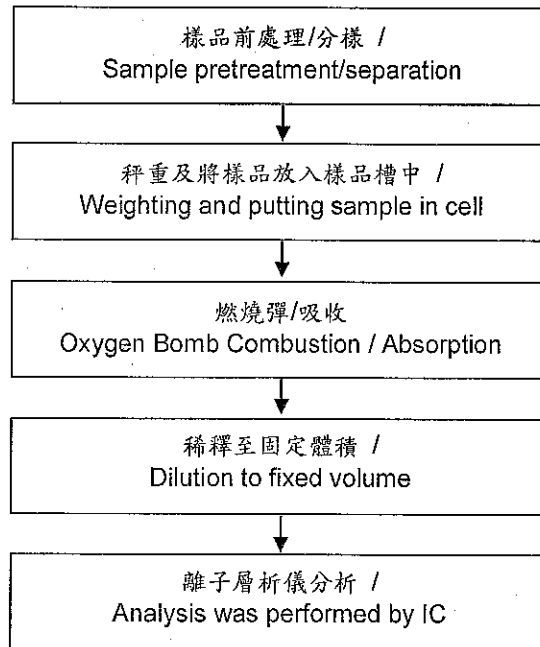

This document is issued by the Company subject to its General Conditions of Service printed overleaf, available on request or accessible at <http://www.sgs.com/eng/Terms-and-Conditions.aspx> and, for electronic format documents, subject to Terms and Conditions for Electronic Documents at <http://www.sgs.com/eng/Terms-and-Conditions/Terms-Document.aspx>. Attention is drawn to the limitation of liability, indemnification and jurisdiction issues defined therein. Any holder of this document is advised that information contained herein reflects the Company's findings at the time of its intervention only and within the limits of client's instruction, if any. The Company's sole responsibility is to its Client and this document does not exonerate parties to a transaction from exercising all their rights and obligations under the transaction documents. This document cannot be reproduced, except in full, without prior written approval of the Company. Any unauthorized alteration, forgery or falsification of the content or appearance of this document is unlawful and offenders may be prosecuted to the fullest extent of the law. Unless otherwise stated the results shown in this test report refer only to the sample(s) tested.



# 測試報告 Test Report

號碼(No.) : CE/2015/B1564

日期(Date) : 2015/11/16

頁數(Page): 12 of 15

西北臺慶科技股份有限公司 / TAI-TECH ADVANCED ELECTRONICS CO., LTD.

(臺慶精密電子(昆山)有限公司 / TAI-TECH ADVANCED ELECTRONICS (KUN-SHAN) CO. LTD.)

(耀鑽科技股份有限公司 / YOSONIC TECHNOLOGY CO., LTD.)

(慶邦電子元器件(泗洪)有限公司 / TAIPAQ ELECTRONICS (SI-HONG) CO., LTD.)

桃園市楊梅區幼獅工業區幼四路1號 / NO. 1, YOU 4TH ROAD, YOUTH INDUSTRIAL DISTRICT, YANG-MEI, TAO-YUAN CITY, TAIWAN, R. O. C.

(江蘇省昆山市蓬朗昆嘉高科技工業區郭澤路 / GUO-ZE ROAD, KUNJIA HI-TECH INDUSTRIAL PARK, KUN-SHAN, JIANG-SU, CHINA)

(桃園市中壢區中壢工業區長春六路15號 / NO. 15, CHANGCHUN 6TH RD., JHONGLI CITY, TAOYUAN COUNTY 320, TAIWAN)

(江蘇省宿遷市泗洪縣經濟開發區金沙南路-高新技術產業園 / HIGH-TECH INDUSTRIAL DISTRICT, JINSHAJIANG ROAD, SIHONG COUNTY ECONOMIC, SUQIAN CITY, JIANGSU)



## 六溴環十二烷分析流程圖 / HBCDD analytical flow chart

- 測試人員：翁賜彬 / Name of the person who made measurement: Roman Wong
- 測試負責人：張啟興 / Name of the person in charge of measurement: Troy Chang

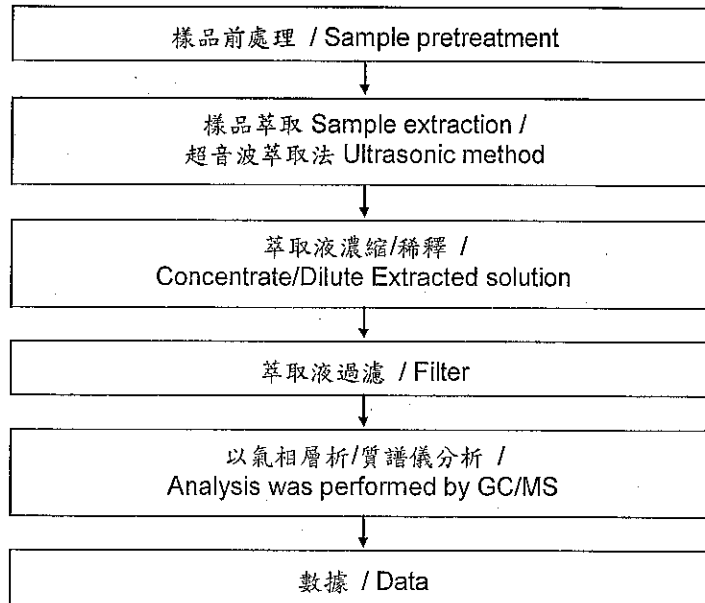

This document is issued by the Company subject to its General Conditions of Service printed overleaf, available on request or accessible at <http://www.sgs.com/ce/Terms-and-Conditions.aspx> and, for electronic format documents, subject to Terms and Conditions for Electronic Documents at <http://www.sgs.com/en/Terms-and-Conditions/Termse-Document.aspx>. Attention is drawn to the limitation of liability, indemnification and jurisdiction issues defined therein. Any holder of this document is advised that information contained herein reflects the Company's findings at the time of its intervention only and within the limits of client's instruction, if any. The Company's sole responsibility is to its Client and this document does not exonerate parties to a transaction from exercising all their rights and obligations under the transaction documents. This document cannot be reproduced, except in full, without prior written approval of the Company. Any unauthorized alteration, forgery or falsification of the content or appearance of this document is unlawful and offenders may be prosecuted to the fullest extent of the law. Unless otherwise stated the results shown in this test report refer only to the sample(s) tested.



# 測試報告 Test Report

號碼(No.) : CE/2015/B1564

日期(Date) : 2015/11/16

頁數(Page): 13 of 15

西北臺慶科技股份有限公司 / TAI-TECH ADVANCED ELECTRONICS CO., LTD.

(臺慶精密電子(昆山)有限公司 / TAI-TECH ADVANCED ELECTRONICS (KUN-SHAN) CO. LTD.)

(耀鑽科技股份有限公司 / YOSONIC TECHNOLOGY CO., LTD.)

(慶邦電子元器件(泗洪)有限公司 / TAIPAQ ELECTRONICS (SI-HONG) CO., LTD.)

桃園市楊梅區幼獅工業區幼四路1號 / NO. 1, YOU 4TH ROAD, YOUTH INDUSTRIAL DISTRICT, YANG-MEI, TAO-YUAN CITY, TAIWAN, R.O.C.

(江蘇省昆山市蓬朗區高科技工業區郭澤路 / GUO-ZE ROAD, KUNJIA HI-TECH INDUSTRIAL PARK, KUN-SHAN, JIANG-SU, CHINA)

(桃園市中壢區中壢工業區長春六路15號 / NO. 15, CHANGCHUN 6TH RD., JHONGLI CITY, TAOYUAN COUNTY 320, TAIWAN)

(江蘇省宿遷市泗洪縣經濟開發區金沙南路-高新技術產業園 / HIGH-TECH INDUSTRIAL DISTRICT, JINSHAJIANG ROAD, SIHONG COUNTY ECONOMIC, SUQIAN CITY, JIANGSU)



## 可塑劑分析流程圖 / Analytical flow chart of phthalate content

- 測試人員：徐毓明 / Name of the person who made measurement: Andy Shu
- 測試負責人：張啟興 / Name of the person in charge of measurement: Troy Chang

### 【測試方法/Test method: IEC 62321-8】

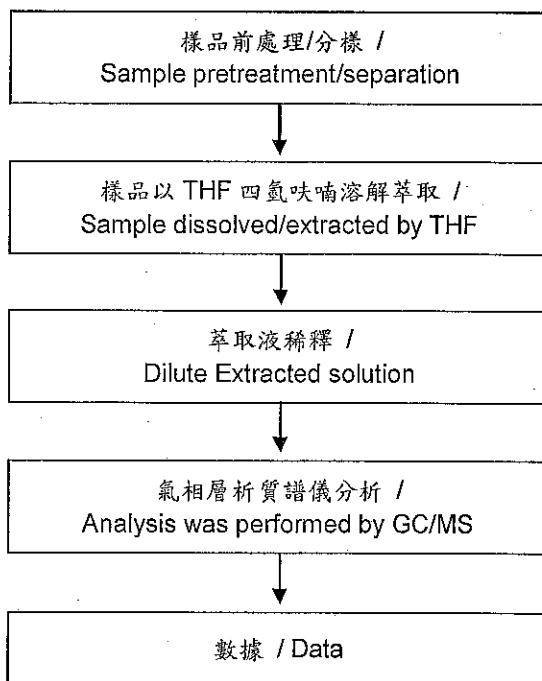

This document is issued by the Company subject to its General Conditions of Service printed overleaf, available on request or accessible at <http://www.sgs.com/en/Terms-and-Conditions.aspx> and, for electronic format documents, subject to Terms and Conditions for Electronic Documents at <http://www.sgs.com/en/Terms-and-Conditions/Termse-Document.aspx>. Attention is drawn to the limitation of liability, indemnification and jurisdiction issues defined therein. Any holder of this document is advised that information contained hereon reflects the Company's findings at the time of its intervention only and within the limits of client's instruction, if any. The Company's sole responsibility is to its Client and this document does not exonerate parties to a transaction from exercising all their rights and obligations under the transaction documents. This document cannot be reproduced, except in full, without prior written approval of the Company. Any unauthorized alteration, forgery or falsification of the content or appearance of this document is unlawful and offenders may be prosecuted to the fullest extent of the law. Unless otherwise stated the results shown in this test report refer only to the sample(s) tested.



# 測試報告 Test Report

號碼(No.) : CE/2015/B1564

日期(Date) : 2015/11/16

頁數(Page): 14 of 15

西北臺慶科技股份有限公司 / TAI-TECH ADVANCED ELECTRONICS CO., LTD.

(臺慶精密電子(昆山)有限公司 / TAI-TECH ADVANCED ELECTRONICS (KUN-SHAN) CO. LTD.)

(耀鑽科技股份有限公司 / YOSONIC TECHNOLOGY CO., LTD.)

(慶邦電子元器件(泗洪)有限公司 / TAIPAQ ELECTRONICS (SI-HONG) CO., LTD.)

桃園市楊梅區幼獅工業區幼四路1號 / NO. 1, YOU 4TH ROAD, YOUTH INDUSTRIAL DISTRICT, YANG-MEI, TAO-YUAN CITY, TAIWAN, R.O.C.

(江蘇省昆山市蓬朗區嘉高科技工業區郭澤路 / GUO-ZE ROAD, KUNJIA HI-TECH INDUSTRIAL PARK, KUN-SHAN, JIANG-SU, CHINA)

(桃園市中壢區中壢工業區長春六路15號 / NO. 15, CHANGCHUN 6TH RD., JHONGLI CITY, TAOYUAN COUNTY 320, TAIWAN)

(江蘇省宿遷市泗洪縣經濟開發區金沙南路-高新技術產業園 / HIGH-TECH INDUSTRIAL DISTRICT, JINSHAJIANG ROAD, SIHONG COUNTY ECONOMIC, SUQIAN CITY, JIANGSU)



## 多溴聯苯/多溴聯苯醚分析流程圖 / PBB/PBDE analytical FLOW CHART

- 測試人員：翁賜彬 / Name of the person who made measurement: Roman Wong
  - 測試負責人：張啟興 / Name of the person in charge of measurement: Troy Chang
- 初次測試程序 / First testing process —————>
- 選擇性篩檢程序 / Optional screen process .....>
- 確認程序 / Confirmation process - - - ->

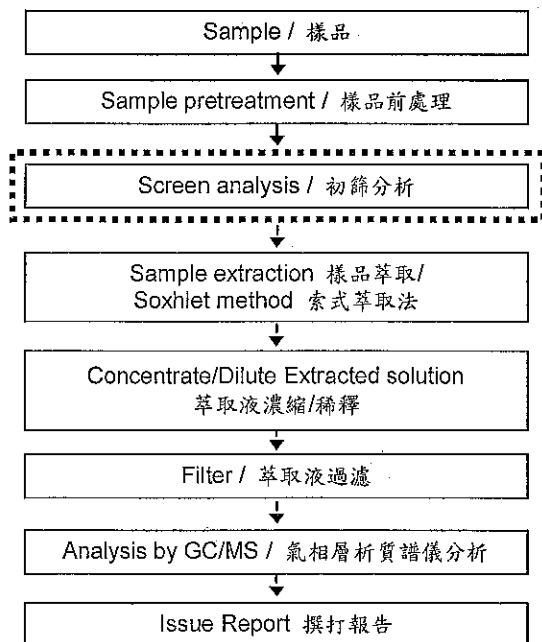

This document is issued by the Company subject to its General Conditions of Service printed overleaf, available on request or accessible at <http://www.sgs.com/en/Terms-and-Conditions.aspx> and, for electronic format documents, subject to Terms and Conditions for Electronic Documents at <http://www.sgs.com/en/Terms-and-Conditions-for-Electronic-Documents.aspx>. Attention is drawn to the limitation of liability, indemnification and jurisdiction issues defined therein. Any holder of this document is advised that information contained hereon reflects the Company's findings at the time of its intervention only and within the limits of client's instruction, if any. The Company's sole responsibility is to its Client and this document does not exonerate parties to a transaction from exercising all their rights and obligations under the transaction documents. This document cannot be reproduced, except in full, without prior written approval of the Company. Any unauthorized alteration, forgery or falsification of the content or appearance of this document is unlawful and offenders may be prosecuted to the fullest extent of the law. Unless otherwise stated the results shown in this test report refer only to the sample(s) tested.



## 測試報告

## Test Report

號碼(No.) : CE/2015/B1564

日期(Date) : 2015/11/16

頁數(Page): 15 of 15

西北臺慶科技股份有限公司 / TAI-TECH ADVANCED ELECTRONICS CO., LTD.

(臺慶精密電子(昆山)有限公司 / TAI-TECH ADVANCED ELECTRONICS (KUN-SHAN) CO. LTD.)

(耀鑽科技股份有限公司 / YOSONIC TECHNOLOGY CO., LTD.)

(慶邦電子元器件(泗洪)有限公司 / TAIPAQ ELECTRONICS (SI-HONG) CO., LTD.)

桃園市場梅區幼獅工業區幼四路1號 / NO. 1, YOU 4TH ROAD, YOUTH INDUSTRIAL DISTRICT, YANG-MEI, TAO-YUAN CITY, TAIWAN, R. O. C.

(江蘇省昆山市蓬朗區嘉高科技工業區郭澤路 / GUO-ZE ROAD, KUNJIA HI-TECH INDUSTRIAL PARK, KUN-SHAN, JIANG-SU, CHINA)

(桃園市中壢區中壢工業區長春六路15號 / NO. 15, CHANGCHUN 6TH RD., JHONGLI CITY, TAOYUAN COUNTY 320, TAIWAN)

(江蘇省宿遷市泗洪縣經濟開發區金沙南路-高新技術產業園 / HIGH-TECH INDUSTRIAL DISTRICT, JINSHAJIANG ROAD, SIHONG COUNTY ECONOMIC, SUQIAN CITY, JIANGSU)



\* 照片中如有箭頭標示，則表示為實際檢測之樣品/部位。\*

(The tested sample / part is marked by an arrow if it's shown on the photo.)

### CE/2015/B1564

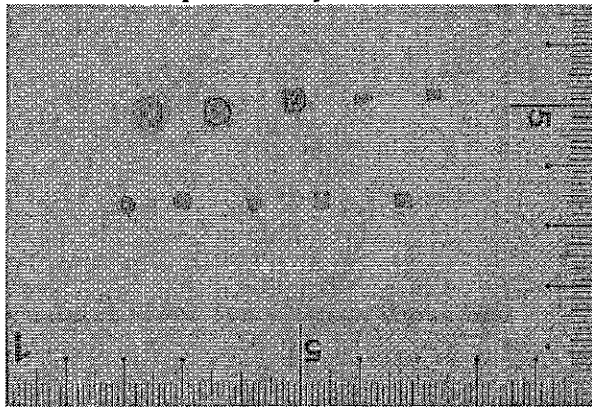

### CE/2015/B1564

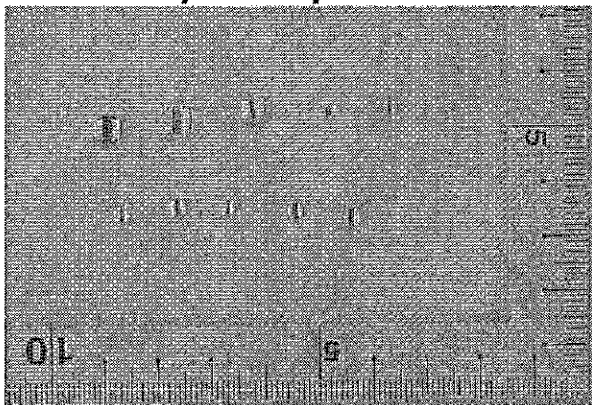

\*\* 報告結尾 (End of Report) \*\*

This document is issued by the Company subject to its General Conditions of Service printed overleaf, available on request or accessible at <http://www.sgs.com/en/Terms-and-Conditions.aspx> and, for electronic format documents, subject to Terms and Conditions for Electronic Documents at <http://www.sgs.com/en/Terms-and-Conditions/Electronic-Documents.aspx>. Attention is drawn to the limitation of liability, indemnification and jurisdiction issues defined therein. Any holder of this document is advised that information contained hereon reflects the Company's findings at the time of its intervention only and within the limits of client's instruction, if any. The Company's sole responsibility is to its Client and this document does not exonerate parties to a transaction from exercising all their rights and obligations under the transaction documents. This document cannot be reproduced, except in full, without prior written approval of the Company. Any unauthorized alteration, forgery or falsification of the content or appearance of this document is unlawful and offenders may be prosecuted to the fullest extent of the law. Unless otherwise stated the results shown in this test report refer only to the sample(s) tested.