

# Specification for Approval

Date: 2017/07/17

Customer : 深圳台慶

TAI-TECH P/N: HPC6045NF-Series(TH)

CUSTOMER P/N: \_\_\_\_\_

DESCRIPTION: \_\_\_\_\_

QUANTITY: \_\_\_\_\_ pcs

REMARK:		
Customer Approval Feedback		

西北臺慶科技股份有限公司  
 TAI-TECH Advanced Electronics Co., Ltd  
 Headquarter:  
 NO.1 YOU 4TH ROAD, YOUTH INDUSTRIAL DISTRICT, YANG-MEI,  
 TAO-YUAN HSIEN, TAIWAN, R.O.C.  
 TEL: +886-3-4641148 FAX: +886-3-4643565  
 http://www.tai-tech.com.tw  
 E-mail: sales@tai-tech.com.tw

Office:  
 深圳辦公室  
 11BC,Building B Fortune Plaza,NO.7002, Shennan Avenue, Futian  
 District Shenzhen  
 TEL: +86- 755-23972371 FAX: +86-755-23972340

臺慶精密電子(昆山)有限公司  
 TAI-TECH ADVANCED ELECTRONICS(KUNSHAN) CO., LTD  
 SHINWHA ROAD, KUNJIA HI-TECH INDUSTRIAL PARK, KUN-SHAN,  
 JIANG-SU, CHINA  
 TEL: +86-512-57619396 FAX: +86-512-57619688  
 E-mail: sales@tai-tech.cn

慶邦電子元器件(泗洪)有限公司  
 TAIPAQ ELECTRONICS (SIHONG) CO., LTD  
 JIN SHA JIANG ROAD , CONOMIC DEVELOPMENT ZONE SIHONG ,  
 JIANGSU , CHINA.  
 TEL: +86-527-88601191 FAX: +86-527-88601190  
 E-mail: sales@taipaq.cn

Sales Dep.

APPROVED	CHECKED
曾詩涵 Angela Tseng	曾詩涵 Angela Tseng

R&D Center

APPROVED	CHECKED	DRAWN
羅宜春	梁周虎	卜文娟

**SMD Power Inductor**

HPC6045NF-Series(TH)

**ECN HISTORY LIST**

REV	DATE	DESCRIPTION	APPROVED	CHECKED	DRAWN
1.0	17/07/17	新發行	羅宜春	梁周虎	卜文娟
備註					

# SMD Power Inductor

HPC6045NF-Series(TH)

## 1. Features

1. This specification applies Low Profile Power Inductors.
2. 100% Lead(Pb) & Halogen-Free and RoHS compliant.



## 2. Dimension

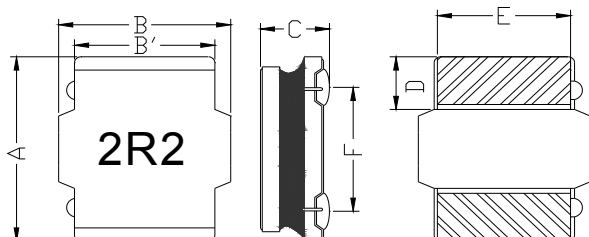

### Recommended Land pattern

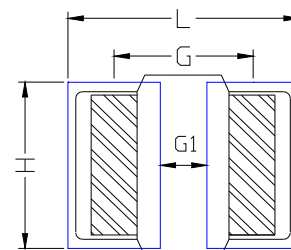

Series	A(mm)	B(mm)	B'(mm)	C(mm)	D(mm)	E(mm)	F(mm)
HPC6045NF	6.0±0.3	6.0±0.3	4.8±0.2	4.2±0.3	1.7±0.3	4.5±0.3	4.25±0.3

L(mm)	G(mm)	G1(mm)	H(mm)
6.5	4.25	1.80min	4.8

Note: 1. The above PCB layout reference only.  
 2. Recommend solder paste thickness at 0.15mm and above.

## 3. Part Numbering



A: Series  
 B: Dimension A/B\*C  
 C: Type  
 D: Inductance 2R2=2.20uh, 100=10uh, 101=100uh, 102=1000uh  
 E: Inductance Tolerance M=±20%, Y=±30%.  
 marking direction cannot decide polarity. Color: Black, unidirectional.  
 magnetic shielding

## 4. Specification

Part Number	Inductance L0 (uH) @ 0 A	Tolerance				Rated current				DCR (mΩ) @25°C ±20%.
						Temperature current I rms (A)		Saturation current I sat (A)		
		K	L	M	Y	Typ	Max	Typ	Max	
HPC6045NF-R36□(TH)	0.36	/	/	±20%	±30%	9.00	8.50	18.00	16.50	4.80
HPC6045NF-R47□(TH)	0.47	/	/	±20%	±30%	8.60	8.00	17.00	16.00	6.80
HPC6045NF-R82□(TH)	0.82	/	/	±20%	±30%	8.20	7.50	14.50	13.50	8.50
HPC6045NF-1R0□(TH)	1.00	/	/	±20%	±30%	8.00	7.30	13.50	12.50	10.0
HPC6045NF-1R2□(TH)	1.20	/	/	±20%	±30%	7.50	7.00	12.50	11.50	10.5
HPC6045NF-1R3□(TH)	1.30	/	/	±20%	±30%	7.50	7.00	12.50	11.50	10.5
HPC6045NF-1R5□(TH)	1.50	/	/	±20%	±30%	7.00	6.60	12.00	11.00	11.7
HPC6045NF-1R8□(TH)	1.80	/	/	±20%	±30%	6.80	6.20	11.00	10.00	12.0
HPC6045NF-2R0□(TH)	2.00	/	/	±20%	±30%	6.50	5.80	10.50	9.50	13.5
HPC6045NF-2R2□(TH)	2.20	/	/	±20%	±30%	6.00	5.30	9.50	8.55	15.0
HPC6045NF-2R3□(TH)	2.30	/	/	±20%	±30%	5.80	5.00	9.30	8.20	16.0
HPC6045NF-3R0□(TH)	3.00	/	/	±20%	±30%	5.20	4.60	8.00	7.50	20.0
HPC6045NF-3R3□(TH)	3.30	/	/	±20%	±30%	5.00	4.50	7.80	7.30	21.0
HPC6045NF-3R6□(TH)	3.60	/	/	±20%	±30%	4.90	4.30	7.40	6.90	22.5
HPC6045NF-4R7□(TH)	4.70	/	±15%	±20%	±30%	4.50	4.00	6.80	6.20	26.0
HPC6045NF-5R6□(TH)	5.60	/	±15%	±20%	±30%	4.10	3.70	6.40	5.70	31.0
HPC6045NF-6R3□(TH)	6.30	/	±15%	±20%	±30%	3.80	3.50	5.90	5.30	33.0
HPC6045NF-6R8□(TH)	6.80	/	±15%	±20%	±30%	3.60	3.30	5.70	5.15	34.0
HPC6045NF-8R2□(TH)	8.20	/	±15%	±20%	±30%	3.40	2.90	5.10	4.50	46.0
HPC6045NF-100□(TH)	10.0	±10%	±15%	±20%	±30%	3.20	2.60	4.60	4.20	52.0
HPC6045NF-150□(TH)	15.0	±10%	±15%	±20%	±30%	2.80	2.20	3.80	3.30	71.0
HPC6045NF-180□(TH)	18.0	±10%	±15%	±20%	±30%	2.60	2.10	3.40	2.90	80.0
HPC6045NF-220□(TH)	22.0	±10%	±15%	±20%	±30%	2.30	1.90	3.30	2.70	96.0
HPC6045NF-330□(TH)	33.0	±10%	±15%	±20%	±30%	1.80	1.50	2.50	2.10	145
HPC6045NF-470□(TH)	47.0	±10%	±15%	±20%	±30%	1.60	1.20	2.00	1.75	200
HPC6045NF-560□(TH)	56.0	±10%	±15%	±20%	±30%	1.40	1.00	1.80	1.65	230
HPC6045NF-680□(TH)	68.0	±10%	±15%	±20%	±30%	1.10	0.92	1.60	1.52	305
HPC6045NF-820□(TH)	82.0	±10%	±15%	±20%	±30%	0.98	0.88	1.50	1.40	365
HPC6045NF-101□(TH)	100	±10%	±15%	±20%	±30%	0.92	0.82	1.33	1.25	456
HPC6045NF-121□(TH)	120	±10%	±15%	±20%	±30%	0.85	0.79	1.20	1.10	500
HPC6045NF-151□(TH)	150	±10%	±15%	±20%	±30%	0.75	0.70	1.10	1.00	626
HPC6045NF-181□(TH)	180	±10%	±15%	±20%	±30%	0.68	0.60	1.00	0.90	745
HPC6045NF-221□(TH)	220	±10%	±15%	±20%	±30%	0.60	0.50	0.88	0.77	900
HPC6045NF-331□(TH)	330	±10%	±15%	±20%	±30%	0.55	0.45	0.60	0.55	1400
HPC6045NF-471□(TH)	470	±10%	±15%	±20%	±30%	0.40	0.35	0.50	0.45	2050

### Note:

- All test data referenced to 25°C ambient, Ls/Q:1MHz/1V.
- Testing Instrument : HP4284A,CH11025,CH3302,CH1320 ,CH1320S LCR METER / Rdc:CH502BC MICRO OHMMETER.
- Heat Rated Current (I rms) will cause the coil temperature rise approximately Δt of 40°C
- Saturation Current (I sat) will cause L0 to drop approximately 30%
- The part temperature (ambient + temp rise) should not exceed 125°C under worst case operating conditions. Circuit design, component, PCB trace size and thickness, airflow and other cooling provisions all affect the part temperature. Part temperature should be verified in the end application.
- Special inquiries besides the above common used types can be met on your requirement.

## 5. Material List

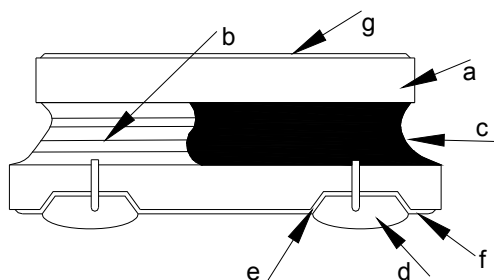

NO	Items	Materials
a	Core	Ferrite Core
b	Wire	Enameled Copper Wire
c	Glue	Epoxy with magnetic powder
d	Terminal	Lead free-Sn Solder
e	Adhesive	Epoxy
f	Copper foil	Pure Copper
g	Ink	Halogen-free ketone

## 6. Reliability and Test Condition

Item	Performance	Test Condition
Operating temperature	-40~+125°C (Including self - temperature rise)	
Storage temperature	1. -10~+40°C, 50~60%RH (Product without taping) 2. -40~+125°C (on board)	
<b>Electrical Performance Test</b>		
Inductance	Refer to standard electrical characteristics list.	HP4284A, CH11025, CH3302, CH1320, CH1320S LCR Meter.
DCR		CH16502, Agilent33420A Micro-Ohm Meter.
Saturation Current (Isat)	Approximately $\Delta L$ 30%.	Saturation DC Current (Isat) will cause L0 to drop $\Delta L$ (%)
Heat Rated Current (Irms)	Approximately $\Delta T$ 40°C	Heat Rated Current (Irms) will cause the coil temperature rise $\Delta T$ (C) 1. Applied the allowed DC current 2. Temperature measured by digital surface thermometer
<b>Reliability Test</b>		
Life Test	Appearance : No damage. Inductance : within $\pm 10\%$ of initial value Q : Shall not exceed the specification value. RDC : within $\pm 15\%$ of initial value and shall not exceed the specification value	Preconditioning: Run through IR reflow for 2 times.( IPC/JEDEC J-STD-020D Classification Reflow Profiles) Temperature : 125 $\pm$ 2°C (Inductor) Applied current : rated current Duration : 1000 $\pm$ 12hrs Measured at room temperature after placing for 24 $\pm$ 2 hrs
Load Humidity		Preconditioning: Run through IR reflow for 2 times.( IPC/JEDEC J-STD-020D Classification Reflow Profiles) Humidity : 85 $\pm$ 2% R.H, Temperature : 85°C $\pm$ 2°C Duration : 1000hrs Min. with 100% rated current Measured at room temperature after placing for 24 $\pm$ 2 hrs
Moisture Resistance		Preconditioning: Run through IR reflow for 2 times.( IPC/JEDEC J-STD-020D Classification Reflow Profiles) 1. Baked at 50°C for 25hrs, measured at room temperature after placing for 4 hrs. 2. Raise temperature to 65 $\pm$ 2°C 90-100%RH in 2.5hrs, and keep 3 hours, cool down to 25°C in 2.5hrs. 3. Raise temperature to 65 $\pm$ 2°C 90-100%RH in 2.5hrs, and keep 3 hours, cool down to 25°C in 2.5hrs, keep at 25°C for 2 hrs then keep at -10°C for 3 hrs 4. Keep at 25°C 80-100%RH for 15min and vibrate at the frequency of 10 to 55 Hz to 10 Hz, measure at room temperature after placing for 1~2 hrs.
Thermal shock		Preconditioning: Run through IR reflow for 2 times.( IPC/JEDEC J-STD-020D Classification Reflow Profiles) Condition for 1 cycle Step1 : -40 $\pm$ 2°C 30 $\pm$ 5min Step2 : 25 $\pm$ 2°C $\leq$ 0.5min Step3 : 125 $\pm$ 2°C 30 $\pm$ 5min Number of cycles : 500 Measured at room temperature after placing for 24 $\pm$ 2 hrs
Vibration		Oscillation Frequency: 10~2K~10Hz for 20 minutes Equipment : Vibration checker Total Amplitude: 1.52mm $\pm$ 10% Testing Time : 12 hours(20 minutes, 12 cycles each of 3 orientations) °

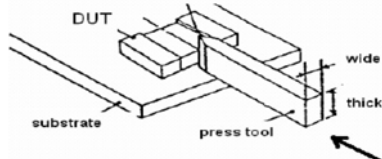
Item	Performance	Test Condition															
Bending	Appearance : No damage.	Shall be mounted on a FR4 substrate of the following dimensions: >=0805 inch(2012mm):40x100x1.2mm <0805 inch(2012mm):40x100x0.8mm Bending depth: >=0805 inch(2012mm):1.2mm <0805 inch(2012mm):0.8mm duration of 10 sec.															
Shock	Impedance : within±15% of initial value Inductance : within±10% of initial value Q : Shall not exceed the specification value. RDC : within ±15% of initial value and shall not exceed the specification value	<table border="1"> <thead> <tr> <th>Type</th> <th>Peak value (g's)</th> <th>Normal duration (D) (ms)</th> <th>Wave form</th> <th>Velocity change (Vi)ft/sec</th> </tr> </thead> <tbody> <tr> <td>SMD</td> <td>50</td> <td>11</td> <td>Half-sine</td> <td>11.3</td> </tr> <tr> <td>Lead</td> <td>50</td> <td>11</td> <td>Half-sine</td> <td>11.3</td> </tr> </tbody> </table>	Type	Peak value (g's)	Normal duration (D) (ms)	Wave form	Velocity change (Vi)ft/sec	SMD	50	11	Half-sine	11.3	Lead	50	11	Half-sine	11.3
Type	Peak value (g's)	Normal duration (D) (ms)	Wave form	Velocity change (Vi)ft/sec													
SMD	50	11	Half-sine	11.3													
Lead	50	11	Half-sine	11.3													
Solder ability	More than 95% of the terminal electrode should be covered with solder .	Preheat: 150 °C, 60sec. ° Solder: Sn96.5% Ag3% Cu0.5% Temperature: 245±5 °C ° Flux for lead free: Rosin. 9.5% ° Dip time: 4±1sec ° Depth: completely cover the termination															
Resistance to Soldering Heat		Depth: completely cover the termination  <table border="1"> <thead> <tr> <th>Temperature(°C)</th> <th>Time(s)</th> <th>Temperature ramp/immersion and emersion rate</th> <th>Number of heat cycles</th> </tr> </thead> <tbody> <tr> <td>260 ±5 (solder temp)</td> <td>10 ±1</td> <td>25mm/s ±6 mm/s</td> <td>1</td> </tr> </tbody> </table>	Temperature(°C)	Time(s)	Temperature ramp/immersion and emersion rate	Number of heat cycles	260 ±5 (solder temp)	10 ±1	25mm/s ±6 mm/s	1							
Temperature(°C)	Time(s)	Temperature ramp/immersion and emersion rate	Number of heat cycles														
260 ±5 (solder temp)	10 ±1	25mm/s ±6 mm/s	1														
Terminal Strength	Appearance : No damage. Impedance : within±15% of initial value Inductance : within±10% of initial value Q : Shall not exceed the specification value. RDC : within ±15% of initial value and shall not exceed the specification value e	Preconditioning: Run through IR reflow for 2 times.( IPC/JEDEC J-STD-020DClassification Reflow Profiles With the component mounted on a PCB with the device to be tested, apply a force(>0805:1kg , <=0805:0.5kg)to the side of a device being tested. This force shall be applied for 60 +1 seconds. Also the force shall be applied gradually as not to apply a shock to the component being tested.  															

Note : When there are questions concerning measurement result : measurement shall be made after 48 ± 2 hours of recovery under the standard condition

## 7. Soldering and Mounting

### (1) Soldering

Mildly activated rosin fluxes are preferred. The minimum amount of solder can lead to damage from the stresses caused by the difference in coefficients of expansion between solder, chip and substrate. TAI-TECH terminations are suitable for re-flow soldering systems. If hand soldering cannot be avoided, the preferred technique is the utilization of hot air soldering tools.

### (2) Solder re-flow:

Recommended temperature profiles for re-flow soldering in Figure 1.

### (3) Soldering Iron:

Products attachment with a soldering iron is discouraged due to the inherent process control limitations. In the event that a soldering iron must be employed the following precautions are recommended.

- Preheat circuit and products to 150°C
- Never contact the ceramic with the iron tip
- Use a 20 watt soldering iron with tip diameter of 1.0mm
- 355°C tip temperature (max)
- 1.0mm tip diameter (max)
- Limit soldering time to 4~5sec.

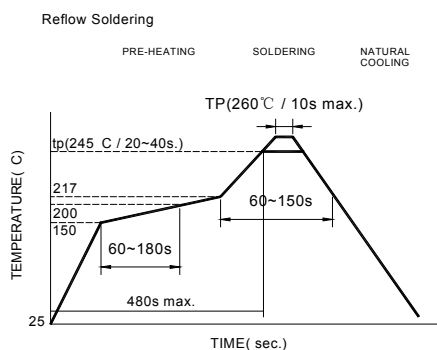

Reflow times: 1 times max.

Fig.1

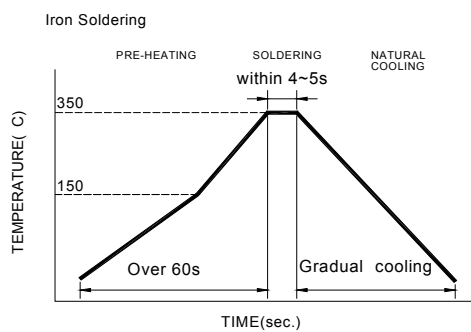

Iron Soldering times: 1 times max.

Fig.2

### 8. Packaging Information

#### (1) Reel Dimension

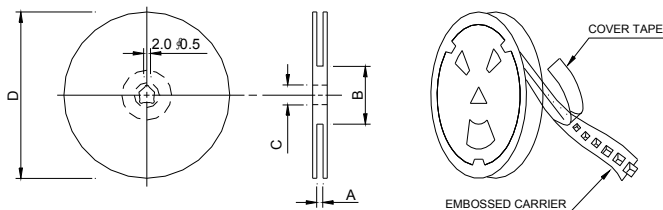

Type	A(mm)	B(mm)	C(mm)	D(mm)
13"x16mm	16.4±2/-0	80±2.0	13+0.5/-0.2	330±3.0

#### (2) Tape Dimension

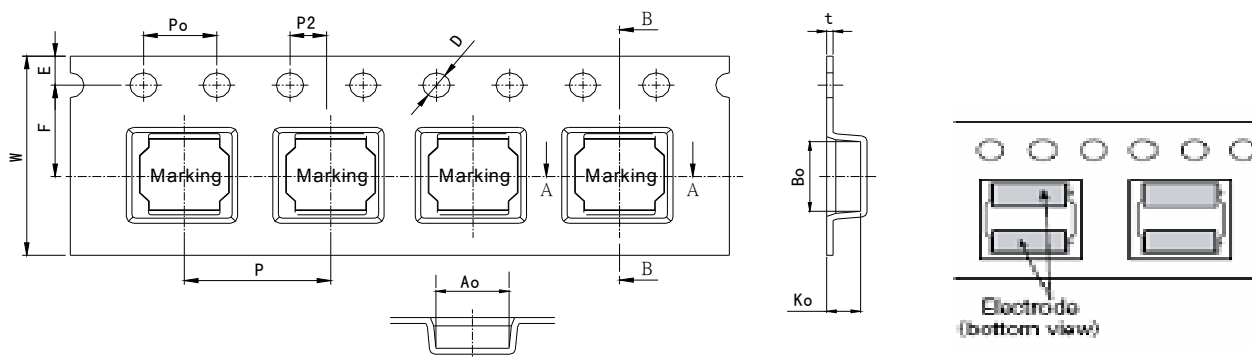

Series	Size	Bo(mm)	Ao(mm)	Ko(mm)	P(mm)	w(mm)	t(mm)	E(mm)	F(mm)	D(mm)	Po(mm)	P2(mm)
HPC	6045	6.4±0.1	6.4±0.1	4.7±0.1	12.0±0.1	16±0.3	0.4±0.1	1.75±0.1	7.5±0.1	1.5±0.1	4.0±0.1	2.00±0.1

#### (3) Packaging Quantity

HPC	6045
Reel	1000
Inner box	2000
Carton	8000

#### (4) Tearing Off Force

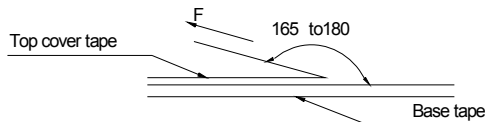

The force for tearing off cover tape is 10 to 130 grams in the arrow direction under the following conditions(referenced ANSI/EIA-481-C-2003 of 4.11 standard).

Room Temp. (°C)	Room Humidity (%)	Room atm (hPa)	Tearing Speed mm/min
5~35	45~85	860~1060	300

#### Application Notice

- Storage Conditions (component level)  
To maintain the solderability of terminal electrodes:
  1. TAI-TECH products meet IPC/JEDEC J-STD-020D standard-MSL, level 1.
  2. Temperature and humidity conditions: Less than 40°C and 60% RH.
  3. Recommended products should be used within 12 months from the time of delivery.
  4. The packaging material should be kept where no chlorine or sulfur exists in the air.
- Transportation
  1. Products should be handled with care to avoid damage or contamination from perspiration and skin oils.
  2. The use of tweezers or vacuum pick up is strongly recommended for individual components.
  3. Bulk handling should ensure that abrasion and mechanical shock are minimized.



### 9. Typical Performance Curves

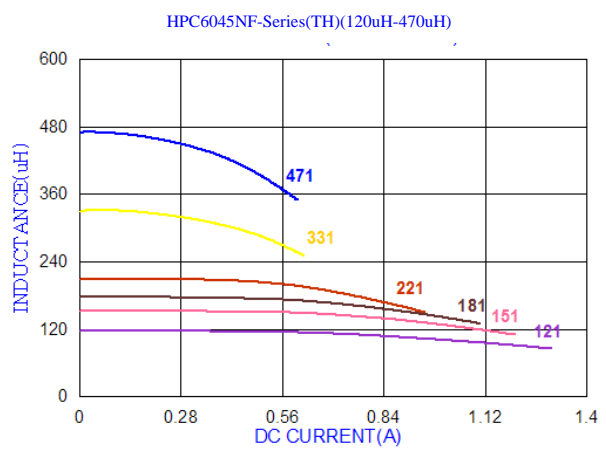
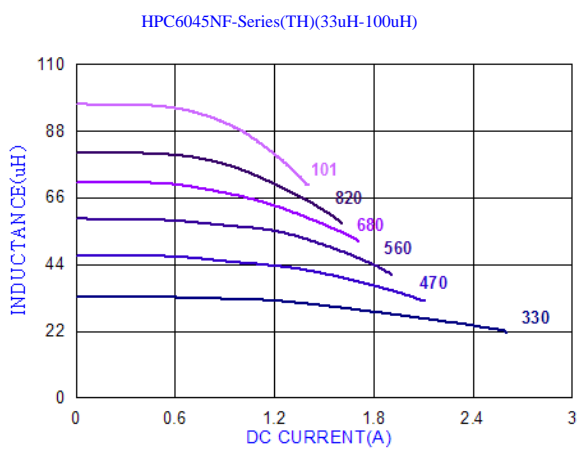
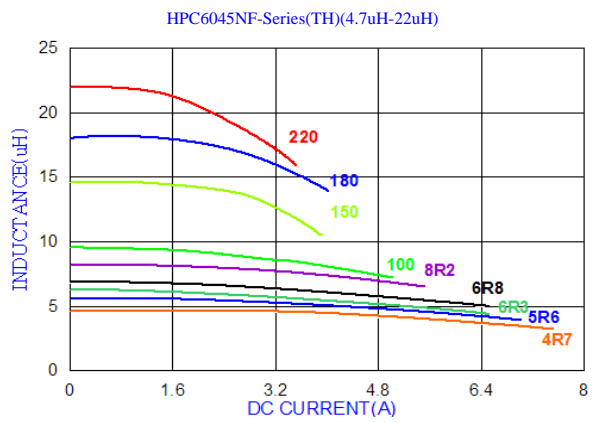
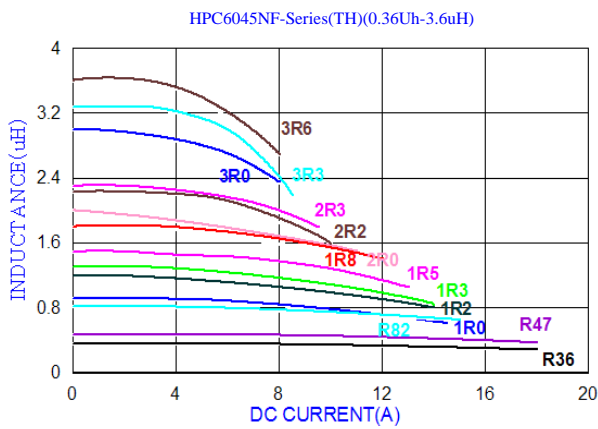
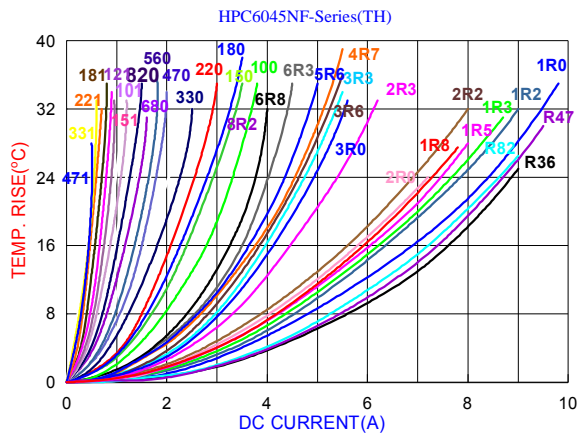

The appearance standard of the chipping size on top side, and bottom side ferrite core is listed below.

Core chipping

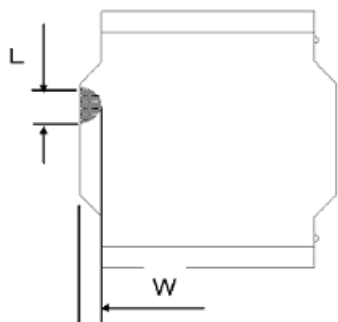

L	W
1.5mm Max.	1.5mm Max.

Void appearance tolerance Limit

Size of voids occurring to coating resin is specified below.

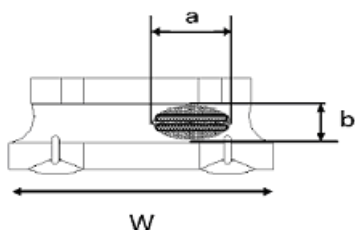

Exposed wire tolerance limit of coating resin part on product side.

Size of exposed wire occurring to coating resin is specified below.

1. Width direction ( dimension a ) : Acceptable when  $a \leq w/2$ .
2. Length direction ( dimension b ) : Dimension b is not specified.
3. The total area of exposed wire occurring to each sides is not greater than 50% of coating resin area, and is acceptable.

External appearance criterion for exposed wire

Exposed end of the winding wire at the secondary side should be 3mm and below.

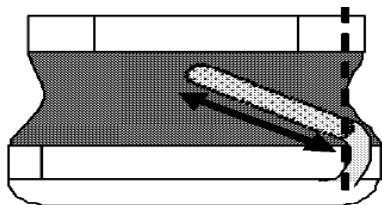

Electrode appearance criterion for exposed wire

Visual check on core surface with no crack means pass.

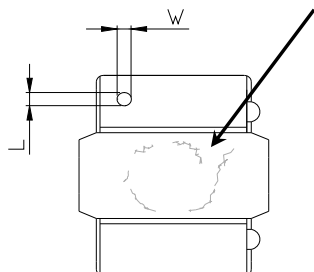

Conforming  
Only top side of wire is exposed.  
(regardless of whole top side of wire exposed)

Wire is soldered insufficiently and less than half of outer diameter is covered with solder.  
Less than 1/2 of joint side length.  
(More than 1/2 is selected as defect)

L	W
1.5mm Max.	1.5mm Max.

Electrodes with foreign body (dirt) appearance standards  
Foreign materials (dirt) will not affect the coplanarity of PAD,  
below the example of foreign materials (dirt) quantity  $\leq 2$ PCS on single PAD.  
dimension range as below.