

Specification for Approval

Date: 2014/08/07

Customer : 東莞台慶

TAI-TECH P/N: HPC8040NF-Series

CUSTOMER P/N: _____

DESCRIPTION: _____

QUANTITY: _____ pcs

REMARK:

Customer Approval Feedback

西北臺慶科技股份有限公司
 TAI-TECH Advanced Electronics Co., Ltd
 Headquarter:
 NO.1 YOU 4TH ROAD, YOUTH INDUSTRIAL DISTRICT, YANG-MEI,
 TAO-YUAN HSIEN, TAIWAN, R.O.C.
 TEL: +886-3-4641148 FAX: +886-3-4643565
 http://www.tai-tech.com.tw
 E-mail: sales@tai-tech.com.tw

東莞臺慶精密電子有限公司
 DONGGUAN TAI-TECH ADVANCED ELECTRONICS CO., LTD
 JITIGANG MANAGEMENT DISTRICT, HUANGJIANG, DONGGUAN,
 GUANGDONG, CHINA
 TEL: +86-769-3365488 FAX: +86-769-3366896
 E-mail: sales@tai-tech.net

Office:
 金亨國際有限公司
 KAMHENG INTERNATIONAL LIMITED
 TEL: +86-852-25772033 FAX: +86-852-28817778

臺慶精密電子(昆山)有限公司
 TAI-TECH ADVANCED ELECTRONICS(KUNSHAN) CO., LTD
 SHINWHA ROAD, KUNJIA HI-TECH INDUSTRIAL PARK, KUN-SHAN,
 JIANG-SU, CHINA
 TEL: +86-512-57619396 FAX: +86-512-57619688
 E-mail: sales@tai-tech.cn

Office:
 北欣國際有限公司
 NORTH STAR INTERNATIONAL LIMITED
 TEL: +86-512-57619396 FAX: +86-512-57619688

慶邦電子元器件(泗洪)有限公司
 TAIPAQ ELECTRONICS (SIHONG) CO., LTD
 JIN SHA JIANG ROAD , CONOMIC DEVELOPMENT ZONE SIHONG ,
 JIANGSU , CHINA.
 TEL: +86-527-88601191 FAX: +86-527-88601190
 E-mail: sales@taipaq.cn

Sales Dep.

APPROVED	CHECKED
管哲頌 Eric Kuan	魏佑娟 Donna Wei

R&D Center

APPROVED	CHECKED	DRAWN
楊祥忠 Mike Yang	詹偉特 Jack Chan	徐允珮 Shelly Hsu

SMD Power Inductor

HPC8040NF-Series

1. Features

- 1. This specification applies Low Profile Power Inductors.
- 2. 100% Lead(Pb) & Halogen-Free and RoHS compliant.



2. Dimension

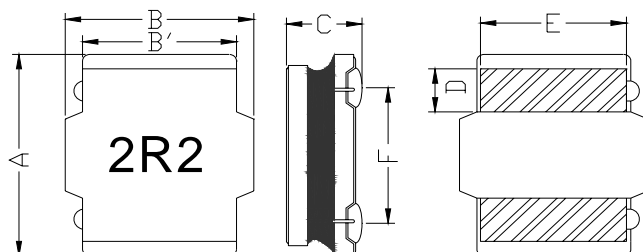

Recommend Land pattern

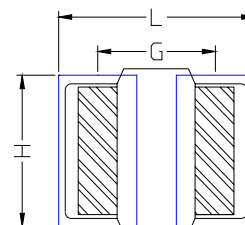

Series	A(mm)	B(mm)	B'(mm)	C(mm)	D(mm)	E(mm)	F(mm)
HPC8040NF	8.0±0.3	8.0±0.3	6.3±0.2	3.7±0.3	2.0±0.3	6.0±0.3	5.5±0.3

L(mm)	G(mm)	H(mm)
8.5	5.3	6.3

3. Part Numbering

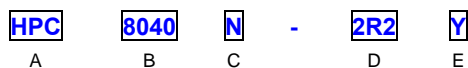

- A: Series
- B: Dimension
- C: Type
- D: Inductance
- E: Inductance Tolerance

A/B*C

2R2=2.20uh 100=10uh,101=100uh,102=1000uh
 K=±10%,M=±20%,Y=±30%.

marking direction cannot decide polarity. Color: Black, unidirectional magnetic shielding

4. Specification

Part Number	Inductance L0 (uH) @ 0 A	Tolerance	Rated current				DCR (mΩ) @25°C ±20%.
			Temperature current I rms (A)		Saturation current I sat (A)		
			Typ	Max	Typ	Max	
HPC8040NF-1R0YTH	1.00	±30%	8.50	8.00	13.80	13.00	8.2
HPC8040NF-1R4YTH	1.40	±30%	8.20	7.80	11.80	11.20	10.0
HPC8040NF-1R5YTH	1.50	±30%	8.00	7.70	11.50	11.00	10.0
HPC8040NF-2R2YTH	2.20	±30%	7.40	6.90	9.80	9.20	11.5
HPC8040NF-3R3YTH	3.30	±30%	6.60	6.20	8.00	7.50	15.0
HPC8040NF-4R7MTH	4.70	±20%	5.80	5.30	6.70	6.00	19.5
HPC8040NF-5R6MTH	5.60	±20%	5.40	5.20	6.20	5.80	22.0
HPC8040NF-6R8MTH	6.80	±20%	5.10	5.00	5.60	5.10	25.0
HPC8040NF-100MTH	10.0	±20%	4.60	4.20	5.00	4.30	33.0
HPC8040NF-150MTH	15.0	±20%	3.60	3.20	4.00	3.60	50.0
HPC8040NF-220MTH	22.0	±20%	2.90	2.45	3.10	2.80	73.0
HPC8040NF-330MTH	33.0	±20%	2.30	2.10	2.60	2.10	100
HPC8040NF-470MTH	47.0	±20%	2.00	1.70	2.20	1.90	135
HPC8040NF-560MTH	56.0	±20%	1.75	1.60	1.90	1.60	160
HPC8040NF-680MTH	68.0	±20%	1.65	1.50	1.75	1.50	205
HPC8040NF-820MTH	82.0	±20%	1.40	1.30	1.60	1.40	230
HPC8040NF-101MTH	100	±20%	1.20	1.10	1.45	1.20	300
HPC8040NF-121MTH	120	±20%	1.10	1.00	1.30	1.10	350
HPC8040NF-151MTH	150	±20%	0.98	0.90	1.20	1.03	410
HPC8040NF-181MTH	180	±20%	0.91	0.83	1.04	0.94	490
HPC8040NF-221MTH	220	±20%	0.85	0.76	0.99	0.90	610

Note:

1. All test data referenced to 25°C ambient , Ls:1MHz/1V.
2. Testing Instrument : HP4284A,CH11025,CH3302,CH1320 ,CH1320S LCR METER / Rdc:CH502BC MICRO OHMMETER.
3. Heat Rated Current (I rms) will cause the coil temperature rise approximately Δt of 40°C (keep 1min.).
4. Saturation Current (Isat) will cause L0 to drop 30% typical. (keep quickly).
5. The part temperature (ambient + temp rise) should not exceed 125°C under worst case operating conditions.Circuit design,component,PCB trace size and thickness,airflow and other cooling provisions all affect the part temperature. Part temperature should be verified in the end application.
6. Special inquiries besides the above common used types can be met on your requirement.

5. Material List

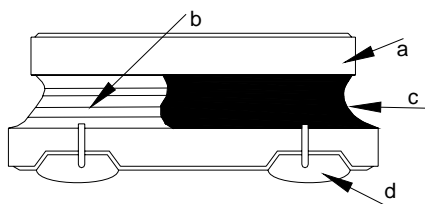

NO	Items	Materials
a	Core	Ferrite Core
b	Wire	Copper Wire
c	Coating	Epoxy with magnetic
d	Solder	Lead free

6. Reliability and Test Condition

Item	Performance	Test Condition															
Operating temperature	-40~+125℃																
Storage temperature	-40~+125℃ (on board)																
Electrical Performance Test																	
Inductance	Refer to standard electrical characteristics list.	HP4284A, CH11025, CH3302, CH1320, CH1320S LCR Meter.															
DCR		CH502BC, Agilent33420A Micro-Ohm Meter.															
Saturation Current (Isat)	△L30% typical.	Saturation DC Current (Isat) will cause L0 to drop △L(%) (keep quickly).															
Heat Rated Current (Irms)	Approximately $\Delta T \leq 40^\circ\text{C}$	Heat Rated Current (Irms) will cause the coil temperature rise $\Delta T(^\circ\text{C})$ without core loss. 1. Applied the allowed DC current (keep 1 min.). 2. Temperature measured by digital surface thermometer															
Reliability Test																	
Life Test	Appearance : No damage. Inductance : within ±10% of initial value Q : Shall not exceed the specification value. RDC : within ±15% of initial value and shall not exceed the specification value	Preconditioning: Run through IR reflow for 2 times. (IPC/JEDEC J-STD-020D Classification Reflow Profiles) Temperature : 125±2℃ (Bead) Temperature : 85±2℃ (Inductor) Applied current : rated current Duration : 1000±12hrs Measured at room temperature after placing for 24±2 hrs															
Load Humidity		Preconditioning: Run through IR reflow for 2 times. (IPC/JEDEC J-STD-020D Classification Reflow Profiles) Humidity : 85±2 % R.H. Temperature : 85℃ ±2℃ Duration : 1000hrs Min. with 100% rated current Measured at room temperature after placing for 24±2 hrs															
Thermal shock		Preconditioning: Run through IR reflow for 2 times. (IPC/JEDEC J-STD-020D Classification Reflow Profiles) Condition for 1 cycle Step1 : -40±2℃ 30±5min Step2 : 25±2℃ ≤0.5min Step3 : 105±2℃ 30±5min Number of cycles : 500 Measured at room temperature after placing for 24±2 hrs															
Vibration		Oscillation Frequency: 10~2K~10Hz for 20 minutes Equipment : Vibration checker Total Amplitude: 1.52mm±10% Testing Time : 12 hours (20 minutes, 12 cycles each of 3 orientations) °															
Shock		<table border="1"> <thead> <tr> <th>Type</th> <th>Peak value (g's)</th> <th>Normal duration (D) (ms)</th> <th>Wave form</th> <th>Velocity change (V)ft/sec</th> </tr> </thead> <tbody> <tr> <td>SMD</td> <td>1500</td> <td>0.5</td> <td>Half-sine</td> <td>15.4</td> </tr> <tr> <td>Lead</td> <td>100</td> <td>6</td> <td>Half-sine</td> <td>12.3</td> </tr> </tbody> </table>	Type	Peak value (g's)	Normal duration (D) (ms)	Wave form	Velocity change (V)ft/sec	SMD	1500	0.5	Half-sine	15.4	Lead	100	6	Half-sine	12.3
Type		Peak value (g's)	Normal duration (D) (ms)	Wave form	Velocity change (V)ft/sec												
SMD	1500	0.5	Half-sine	15.4													
Lead	100	6	Half-sine	12.3													
Bending	Shall be mounted on a FR4 substrate of the following dimensions: ≥0805: 40x100x1.2mm <0805: 40x100x0.8mm Bending depth: ≥0805: 1.2mm <0805: 0.8mm duration of 10 sec.																

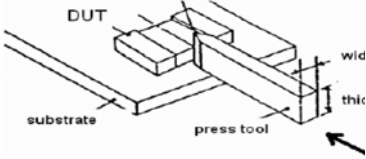
Item	Performance	Test Method and Remarks						
Soderability	More than 95% of the terminal electrode should be covered with solder °	Preheat: 150°C, 60sec. ° Solder: Sn99.5%-Cu0. 5% ° Temperature: 245±5°C ° Flux for lead free: Rosin. 9.5% ° Dip time: 4±1sec ° Depth: completely cover the termination						
Resistance to Soldering Heat		Number of heat cycles: 1 <table border="1"> <thead> <tr> <th>Temperature (°C)</th> <th>Time(s)</th> <th>Temperature ramp/immersion and emersion rate</th> </tr> </thead> <tbody> <tr> <td>260 ±5(solder temp)</td> <td>10 ±1</td> <td>25mm/s ±6 mm/s</td> </tr> </tbody> </table>	Temperature (°C)	Time(s)	Temperature ramp/immersion and emersion rate	260 ±5(solder temp)	10 ±1	25mm/s ±6 mm/s
Temperature (°C)	Time(s)	Temperature ramp/immersion and emersion rate						
260 ±5(solder temp)	10 ±1	25mm/s ±6 mm/s						
Terminal Strength	Appearance : No damage. Inductance : within±10% of initial value Q : Shall not exceed the specification value. RDC : within ±15% of initial value and shall not exceed the specification value	Preconditioning: Run through IR reflow for 2 times.(IPC/JEDEC J-STD-020DClassification Reflow Profiles With the component mounted on a PCB with the device to be tested, apply a force (>0.805:1kg , <=0.805:0.5kg)to the side of a device being tested. This force shall be applied for 60 +1 seconds. Also the force shall be applied gradually as not to apply a shock to the component being tested. 						

7. Soldering and Mounting

(1) Soldering

Mildly activated rosin fluxes are preferred. The minimum amount of solder can lead to damage from the stresses caused by the difference in coefficients of expansion between solder, chip and substrate. TAI-TECH terminations are suitable for re-flow soldering systems. If hand soldering cannot be avoided, the preferred technique is the utilization of hot air soldering tools.

(2) Solder re-flow:

Recommended temperature profiles for re-flow soldering in Figure 1.

(3) Soldering Iron:

Products attachment with a soldering iron is discouraged due to the inherent process control limitations. In the event that a soldering iron must be employed the following precautions are recommended.

- Preheat circuit and products to 150°C
- Never contact the ceramic with the iron tip
- Use a 20 watt soldering iron with tip diameter of 1.0mm
- 355°C tip temperature (max)
- 1.0mm tip diameter (max)
- Limit soldering time to 4~5sec.

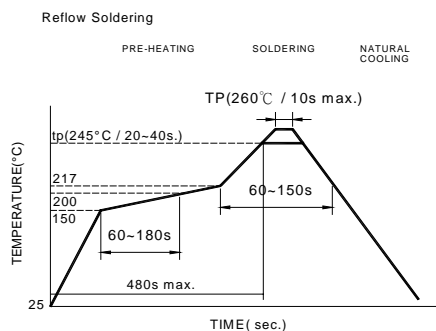

Reflow times: 1 times max.

Fig.1

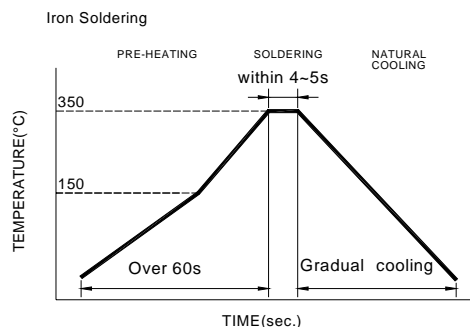

Iron Soldering times: 1 times max.

Fig.2

8. Packaging Information

(1) Reel Dimension

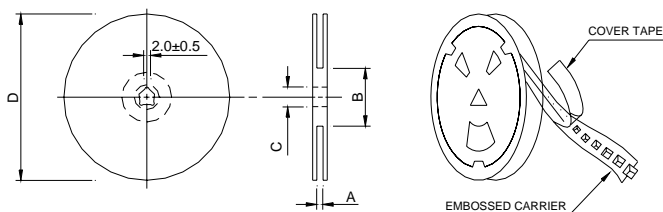

Type	A(mm)	B(mm)	C(mm)	D(mm)
13"x16mm	16.5±0.5	80±2.0	13.5±0.5	330±3.0

(2) Tape Dimension

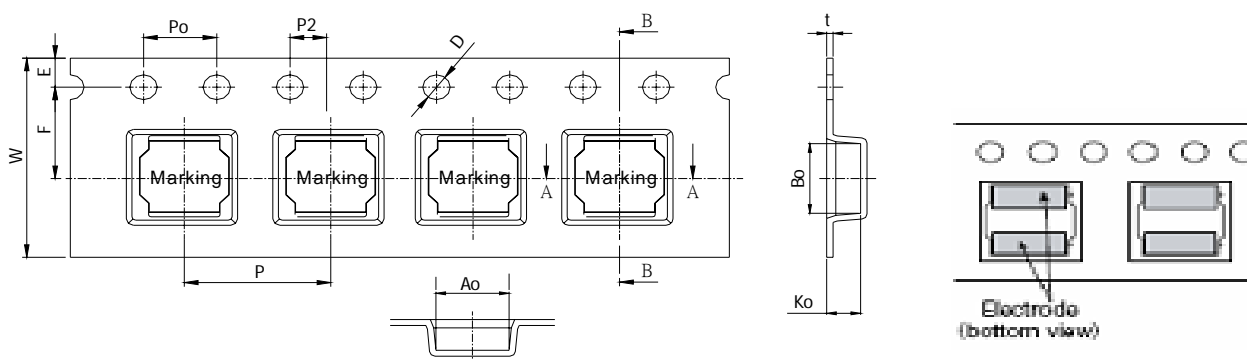

Series	Size	Bo(mm)	Ao(mm)	Ko(mm)	P(mm)	w(mm)	t(mm)	Emm	F(mm)	D(mm)	Po(mm)	P2(mm)
HPC	8040	8.4±0.1	8.4±0.1	4.3±0.1	12±0.1	16±0.3	0.4±0.1	1.75±0.1	7.5±0.1	1.5±0.1	4.0±0.1	2.00±0.1

(3) Packaging Quantity

HPC	8040
Reel	1000
Inner box	2000
Carton	8000

(4) Tearing Off Force

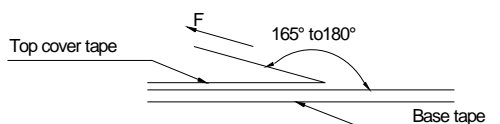

The force for tearing off cover tape is 10 to 130 grams in the arrow direction under the following conditions(referenced ANSI/EIA-481-C-2003 of 4.11 stadnard).

Room Temp. (°C)	Room Humidity (%)	Room atm (hPa)	Tearing Speed mm/min
5~35	45~85	860~1060	300

Application Notice

- Storage Conditions (component level)
To maintain the solderability of terminal electrodes:
 1. TAIPAQ products meet IPC/JEDEC J-STD-020D standard-MSL, level 1.
 2. Temperature and humidity conditions: Less than 40°C and 60% RH.
 3. Recommended products should be used within 12 months form the time of delivery.
 4. The packaging material should be kept where no chlorine or sulfur exists in the air.
- Transportation
 1. Products should be handled with care to avoid damage or contamination from perspiration and skin oils.
 2. The use of tweezers or vacuum pick up is strongly recommended for individual components.
 3. Bulk handling should ensure that abrasion and mechanical shock are minimized.

9. Typical Performance Curves

